

ACPL-K70A/K73A

Low Input Current, High Current Gain, LVTTTL, LVCMOS Optocoupler

Description

These high gain series couplers use a light-emitting diode (LED) and an integrated high gain photodetector to provide an extremely high current transfer ratio between input and output. Separate pins for photodiode and output stage result in LVTTTL-compatible saturation voltages and high-speed operation. Where desired, the V_{CC} and V_O terminals may be tied together to achieve conventional photo-darlington operation. A base access terminal allows a gain bandwidth adjustment to be made.

These optocouplers are for use in LVTTTL/LVCMOS or other low-power applications.

The ACPL-K70A and ACPL-K73A are surface-mount devices that are packaged in an industry-standard stretched SOIC-8 footprint.

The stretched SOIC-8 does not require through holes in a PCB.

Figure 1: Functional Diagram

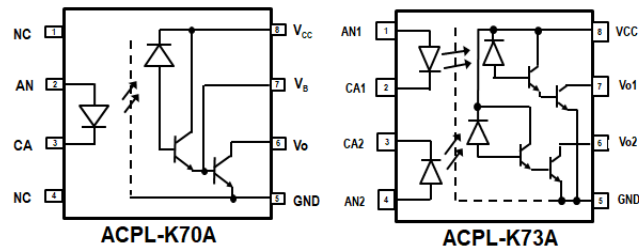

Table 1: Truth Table

LED	Output
ON	L
OFF	H

A 0.1- μ F bypass capacitor must be connected between pins V_{CC} and GND.

Features

- 3.3V/5V dual supply voltages
- Low power consumption
- High current transfer ratio
- Low input current requirements: 0.04 mA
- Stretched SO8 package
- LVTTTL/LVCMOS compatible output
- Guaranteed performance within the temperature range -40°C to $+105^{\circ}\text{C}$
- Base access allows gain bandwidth adjustment
- High output current: 60 mA
- Worldwide Safety Approval:
 - UL1577 recognized: 5000 V_{rms} /1 min
 - CSA approval
 - IEC 60747-5-5 approval for reinforced insulation

Applications

- EIA RS-232C/low input current line receiver
- Low power systems: ground isolation
- Line voltage status indicator; low input power dissipation

CAUTION! Take normal static precautions in handling and assembling this component to prevent damage and/or degradation that may be induced by ESD. The components featured in this data sheet are not to be used in military or aerospace applications or environments.

Ordering Information

ACPL-K70A/K73A is UL recognized with 5000 V_{rms} for 1 minute per UL 1577.

Part Number	Option	Package	Surface Mount	Tape & Reel	UL 1577	IEC 60747-5-5	Quantity
	RoHS Compliant						
ACPL-K70A/K73A	-000E	Stretched SO8	X		X		80 per tube
	-060E		X		X	X	80 per tube
	-500E		X	X	X		1000 per reel
	-560E		X	X	X	X	1000 per reel

To form an order entry, choose a part number from the Part Number column and combine with the desired option from the Option column.

Package Outline Drawing

Figure 2: ACPL-K70A/K73A Stretched SO8 Package

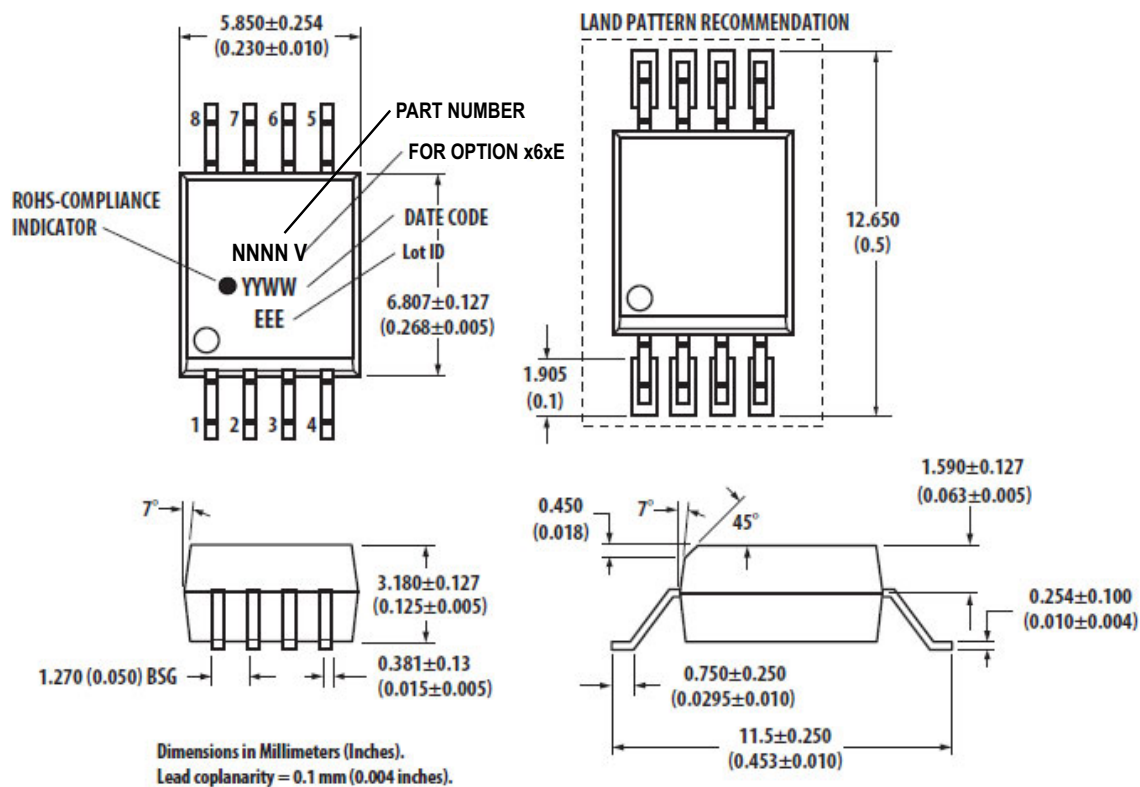

Solder Reflow Profile

Recommended reflow condition as per JEDEC standard J-STD-020 (latest revision). Non-halide flux should be used.

Regulatory Information

The ACPL-K70A/K73A is pending approval by the following organizations:

- **UL** – Approval under UL 1577, component recognition program up to $V_{ISO} = 5000 V_{RMS}$ File E55361.
- **CSA** – Approval under CSA Component Acceptance Notice #5, File CA 88324.
- **IEC 60747-5-5**

Table 2: Insulation and Safety Related Specifications

Parameter	Symbol	ACPL-K70A/K73A	Units	Conditions
Minimum External Air Gap (External Clearance)	L(101)	8	mm	Measured from input terminals to output terminals, shortest distance through air.
Minimum External Tracking (External Creepage)	L(102)	8	mm	Measured from input terminals to output terminals, shortest distance path along body.
Minimum Internal Plastic Gap (Internal Clearance)	—	0.08	mm	Through insulation distance conductor to conductor, usually the straight line distance thickness between the emitter and detector.
Tracking Resistance (Comparative Tracking Index)	CTI	175	V	DIN IEC 112/VDE 0303 Part 1.
Isolation Group	—	IIIa	—	Material Group (DIN VDE 0110, 1/89, Table 1).

Table 3: IEC 60747-5-5 Insulation Characteristics¹

Description	Symbol	Characteristic ACPL-K70A/K73A	Unit
Installation classification per DIN VDE 0110/39, Table 1 For rated mains voltage $\leq 150 V_{rms}$ For rated mains voltage $\leq 300 V_{rms}$ For rated mains voltage $\leq 600 V_{rms}$ For rated mains voltage $\leq 1000 V_{rms}$	—	I - IV I - IV I - IV I - III	—
Climatic Classification	—	40/105/21	—
Pollution Degree (DIN VDE 0110/39)	—	2	—
Maximum Working Insulation Voltage	V_{IORM}	1140	V_{peak}
Input to Output Test Voltage, Method b ¹ $V_{IORM} \times 1.875 = V_{PR}$, 100% Production Test with $t_m = 1$ sec, Partial discharge < 5 pC	V_{PR}	2137	V_{peak}
Input to Output Test Voltage, Method a ¹ $V_{IORM} \times 1.6 = V_{PR}$, Type and Sample Test, $t_m = 10$ sec, Partial discharge < 5 pC	V_{PR}	1824	V_{peak}
Highest Allowable Overvoltage (Transient Overvoltage $t_{ini} = 60$ sec)	V_{IOTM}	8000	V_{peak}

Table 3: IEC 60747-5-5 Insulation Characteristics¹ (Continued)

Description	Symbol	Characteristic ACPL- K70A/K73A	Unit
Safety-limiting values: maximum values allowed in the event of a failure.			
Case Temperature	T_S	175	°C
Input Current	$I_{S, INPUT}$	230	mA
Output Power	$P_{S, OUTPUT}$	600	mW
Insulation Resistance at T_S , $V_{IO} = 500 V$	R_S	$>10^9$	Ω

1. Refer to the optocoupler section of the *Isolation and Control Components Designer's Catalog*, under the "Product Safety Regulations" section, (IEC 60747-5-5) for a detailed description of Method a and Method b partial discharge test profiles.

Table 4: Absolute Maximum Ratings

Parameter	Symbol	Min.	Max.	Units
Storage Temperature	T_S	-55	125	°C
Operating Temperature	T_A	-40	105	°C
Lead Soldering Cycle	Temperature		260	°C
	Time		10	s
Average Forward Input Current	$I_{F(avg)}$	—	20	mA
Peak Forward Input Current (50% duty cycle, 1-ms pulse width)	$I_{F(peak)}$	—	40	mA
Peak Transient Input Current ($\leq 1 \mu s$ pulse width, 300 pps)	$I_{F(trans)}$	—	1.0	A
Reversed Input Voltage	V_R	—	5	V
Input Power Dissipation	P_{IN}	—	35	mW
Output Power Dissipation	P_O	—	100	mW
Output Current	$I_{O(AVG)}$	—	60	mA
Emitter Base Reverse Voltage (Pin 5–7)	V_{EB}	—	0.5	V
Output Transistor Base Current	I_B	—	5	mA
Supply Voltage and Output Voltage	V_{CC}	-0.5	18	V
Solder Reflow Temperature Profile	See Package Outline Drawing .			

Table 5: Recommended Operating Conditions

Parameter	Symbol	Min.	Max.	Units
Supply Voltage	V_{CC}	3.3	18.0	V
Forward Input Current (ON)	$I_{F(ON)}$	0.04	12	mA
Operating Temperature	T_A	-40	105	°C
Forward Input Voltage (OFF)	$V_{F(OFF)}$	—	0.8	V
Output Current	$I_{O(AVG)}$	—	25	mA

Table 6: Electrical Specifications (DC)

Over-recommended operating ($T_A = -40^\circ\text{C}$ to 105°C) unless otherwise specified. All typical specifications are at $T_A = 25^\circ\text{C}$.

Parameter	Sym.	Min.	Typ.	Max.	Units	Conditions	Fig.	
Current Transfer Ratio	CTR ¹	800	8000	25,000	%	$I_F = 0.04 \text{ mA}$	$V_{CC} = 3.3\text{V}$ or 5V $V_O = 0.4\text{V}$	4, 5
		400	3500	8000	%	$I_F = 0.5 \text{ mA}$		
		300	1980	5000	%	$I_F = 1.6 \text{ mA}$		
Logic Low Output Voltage	V_{OL}	—	0.02	0.4	V	$I_F = 0.04 \text{ mA}$ $I_O = 280 \mu\text{A}$	$V_{CC} = 3.3\text{V}$ or 5V	—
		—	0.04	0.4	V	$I_F = 0.5 \text{ mA}$ or 1.6 mA , $I_O = 3.0 \text{ mA}$		—
Logic High Output Current	I_{OH}	—	0.003	5	μA	$-40^\circ\text{C} \leq T_A \leq 70^\circ\text{C}$	$V_O = V_{CC} = 3.3\text{V}$ or 5V $I_F = 0 \text{ mA}$	—
		—	18	100	μA	$70^\circ\text{C} < T_A \leq 105^\circ\text{C}$		
		—	0.01	80	μA	$-40^\circ\text{C} \leq T_A \leq 70^\circ\text{C}$	$V_O = V_{CC} = 18\text{V}$ $I_F = 0 \text{ mA}$	—
		—	50	250	μA	$70^\circ\text{C} < T_A \leq 105^\circ\text{C}$		
Logic Low Supply Current ²	I_{CCL}	—	0.03	0.2	mA	$I_F = 0.04 \text{ mA}$	$V_O = \text{open}$ $V_{CC} = 18\text{V}$	—
		—	0.53	1	mA	$I_F = 0.5 \text{ mA}$		
		—	1.75	2.5	mA	$I_F = 1.6 \text{ mA}$		
Logic High Supply Current ²	I_{CCH}	—	0.08	10	μA	$I_F = 0 \text{ mA}$ $V_O = \text{open}$ $V_{CC} = 18\text{V}$	—	—
Input Forward Voltage	V_F	—	1.3	1.7	V	$I_F = 0.04 \text{ mA}$ to 1.6 mA	—	3
		—	1.4	1.8	V	$I_F = 12 \text{ mA}$		
Input Reversed Breakdown Voltage	BV_R	2.5	5	—	V	$I_R = 100 \mu\text{A}$	—	—
Temperature Coefficient of Forward Voltage	$\Delta V_F / \Delta T_A$	—	-1.6	—	$\text{mV}/^\circ\text{C}$	$I_F = 1.6 \text{ mA}$	—	—
Input Capacitance	C_{IN}	—	18	—	pF	$f = 1 \text{ MHz}$ $V_F = 0$	—	—

1. Current transfer ratio in percent is defined as the ratio of output collector current, I_O , to the forward LED input current, I_F , multiplied by 100%.

2. Each channel.

Table 7: Switching Specifications

Over-recommended operating ($T_A = -40^\circ\text{C}$ to 105°C) unless otherwise specified. All typical specifications are at $T_A = 25^\circ\text{C}$.

Parameter	Symbol	Min.	Typ.	Max.	Units	Test Conditions	Fig.	
Propagation Delay Time to Logic Low at Output	t_{PHL}	—	36	500	μs	$I_F = 0.04 \text{ mA}$ $V_{\text{CC}} = 3.3/5.0\text{V}$ $R_L = 11 \text{ k}\Omega$	8, 9, 14	
		—	3.5	30	μs	$I_F = 0.5 \text{ mA}$ $V_{\text{CC}} = 3.3/5.0\text{V}$ $R_L = 4.7 \text{ k}\Omega$	10, 11, 14	
		—	1.2	25	μs	$I_F = 1.6 \text{ mA}$ $V_{\text{CC}} = 3.3/5.0\text{V}$ $R_L = 2.2 \text{ k}\Omega$	14	
		—	0.2	2	μs	$I_F = 12 \text{ mA}$ $V_{\text{CC}} = 3.3/5.0\text{V}$ $R_L = 270\Omega$	12, 13, 14	
Propagation Delay Time to Logic High at Output	t_{PLH}	—	170	1500	μs	$I_F = 0.04 \text{ mA}$ $R_L = 11 \text{ k}\Omega$	$V_{\text{CC}} = 3.3\text{V}$	8, 9, 14
		—	100	800	μs		$V_{\text{CC}} = 5.0\text{V}$	
		—	85	700	μs	$I_F = 0.5 \text{ mA}$ $R_L = 4.7 \text{ k}\Omega$	$V_{\text{CC}} = 3.3\text{V}$	10, 11, 14
		—	50	500	μs		$V_{\text{CC}} = 5.0\text{V}$	
		—	43	400	μs	$I_F = 1.6 \text{ mA}$ $R_L = 2.2 \text{ k}\Omega$	$V_{\text{CC}} = 3.3\text{V}$	14
		—	26	300	μs		$V_{\text{CC}} = 5.0\text{V}$	
		—	7	80	μs	$I_F = 12 \text{ mA}$ $R_L = 270\Omega$	$V_{\text{CC}} = 3.3\text{V}$	12, 13, 14
		—	4.2	40	μs		$V_{\text{CC}} = 5.0\text{V}$	
Common Mode Transient Immunity at Logic High Output ¹	$ CM_H $	10	—	—	$\text{kV}/\mu\text{s}$	$T_A = 25^\circ\text{C}$ $V_{\text{CM}} = 1000\text{V}$ $I_F = 0 \text{ mA}$ $R_L = 270\Omega$ $V_{\text{CC}} = 3.3\text{V}/5\text{V}$	15	
Common Mode Transient Immunity at Logic Low Output ²	$ CM_L $	10	—	—	$\text{kV}/\mu\text{s}$	$T_A = 25^\circ\text{C}$ $V_{\text{CM}} = 1000\text{V}$ $I_F = 12 \text{ mA}$ $R_L = 270\Omega$ $V_{\text{CC}} = 3.3\text{V}/5\text{V}$	15	

1. Common transient immunity in a Logic High level is the maximum tolerable (positive) dV_{CM}/dt on the rising edge of the common mode pulse, V_{CM} , to ensure that the output will remain in a Logic High state (that is, $V_O > 2.0\text{V}$).
2. Common mode transient immunity in a Logic Low level is the maximum tolerable (negative) dV_{CM}/dt on the falling edge of the common mode pulse signal, V_{CM} to ensure that the output will remain in a Logic Low state (that is, $V_O < 0.8\text{V}$).

Table 8: Package Characteristics

All typical specifications are at $T_A = 25^\circ\text{C}$.

Parameter	Symbol	Min.	Typ.	Max.	Units	Test Conditions
Input-Output Momentary Withstand Voltage ¹	V_{ISO}	5000	—	—	V_{rms}	$RH \leq 50\%$, $t = 1 \text{ min.}$, $T_A = 25^\circ\text{C}$
Input-Output Resistance ¹	$R_{\text{I-O}}$	—	10^{12}	—	Ω	$V_{\text{I-O}} = 500 \text{ Vdc}$
Input-Output Capacitance ¹	$C_{\text{I-O}}$	—	0.6	—	pF	$f = 1 \text{ MHz}$, $T_A = 25^\circ\text{C}$

1. Device considered a two-terminal device: pins 1, 2, 3, and 4 shorted together, and pins 5, 6, 7, and 8 shorted together.

Figure 3: Input Current vs. Forward Voltage

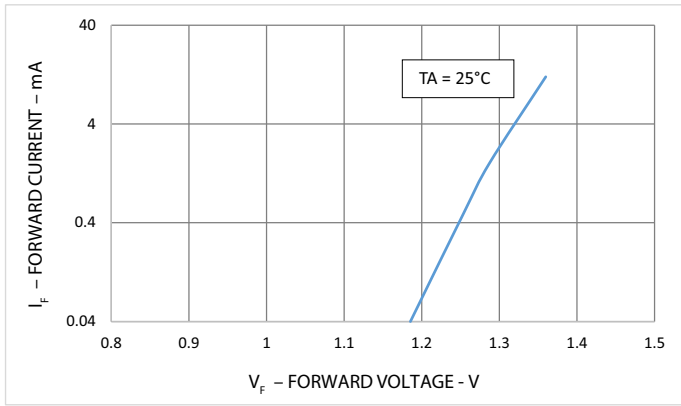

Figure 4: Current Transfer Ratio vs Forward Current

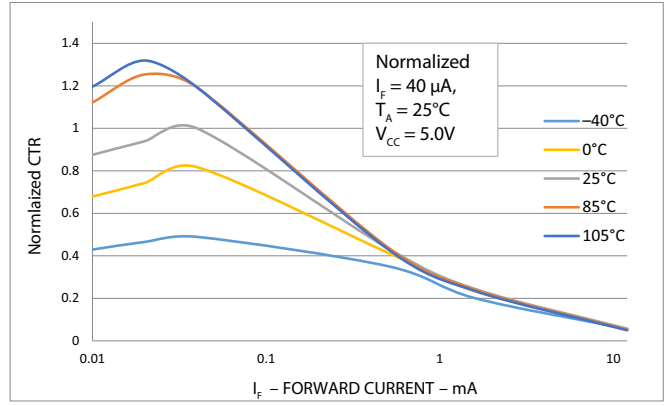

Figure 5: Current Transfer Ratio vs Forward Current

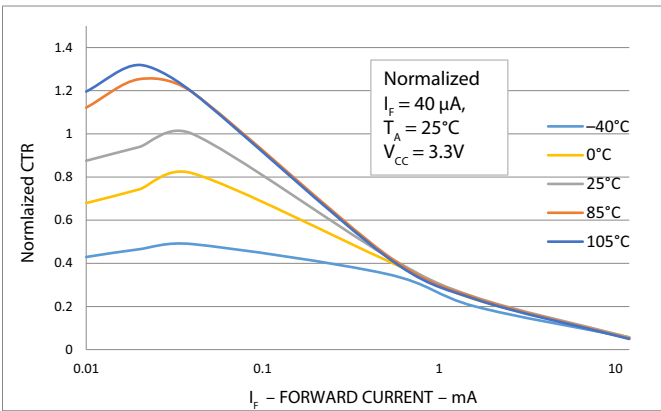

Figure 6: Logic Low Output Current vs. Temperature

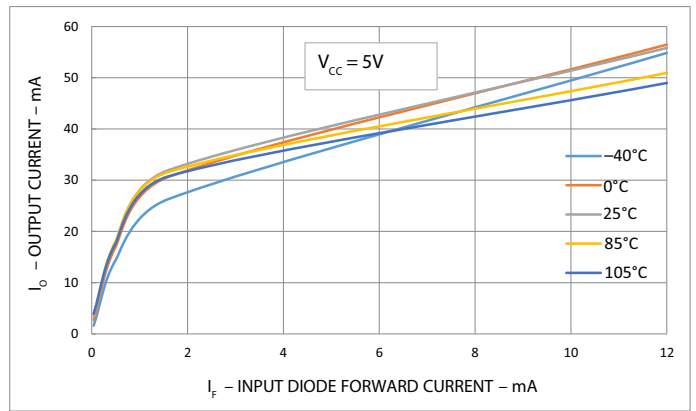

Figure 7: Logic Low Output Current vs. Temperature

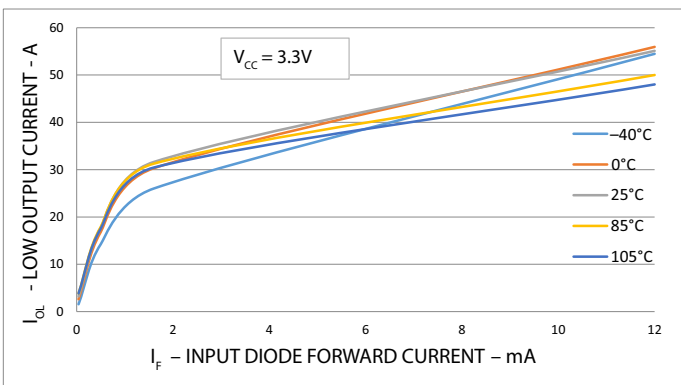

Figure 8: Typical Propagation Delay vs. Temperature

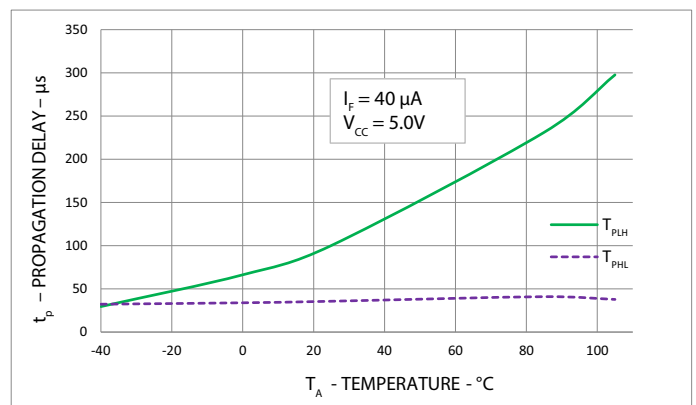

Figure 9: Typical Propagation Delay vs. Temperature

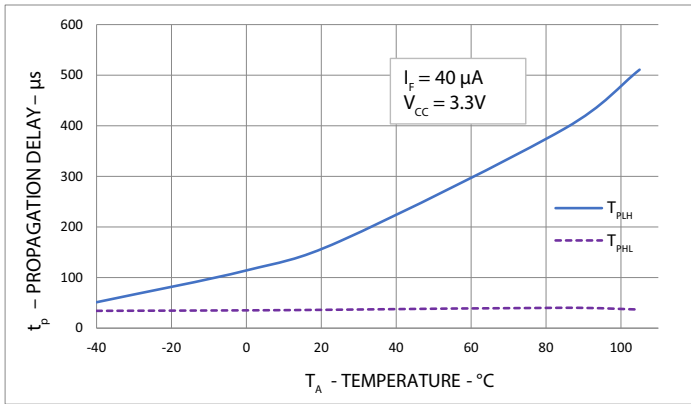

Figure 10: Typical Propagation Delay vs. Temperature

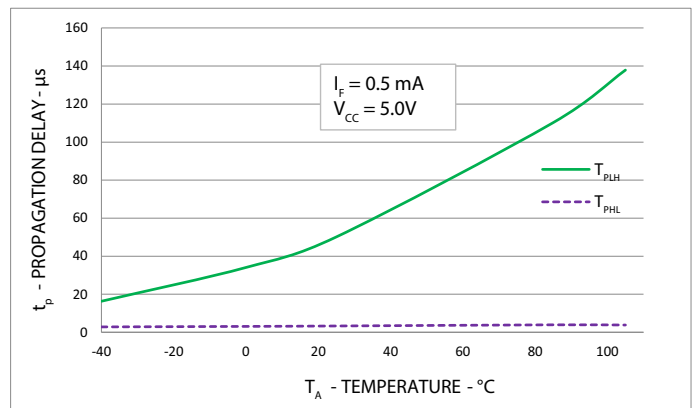

Figure 11: Typical Propagation Delay vs. Temperature

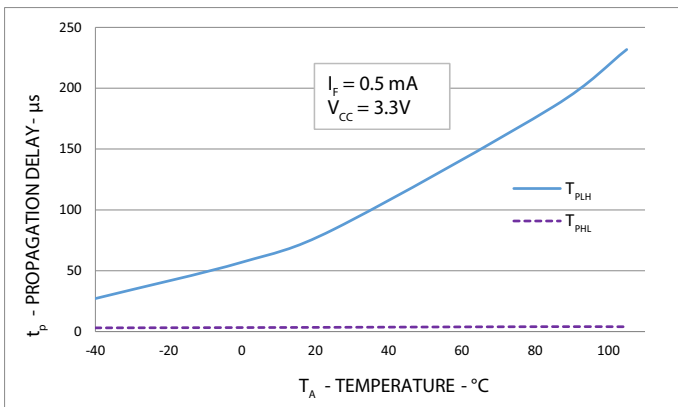

Figure 12: Typical Propagation Delay vs. Temperature

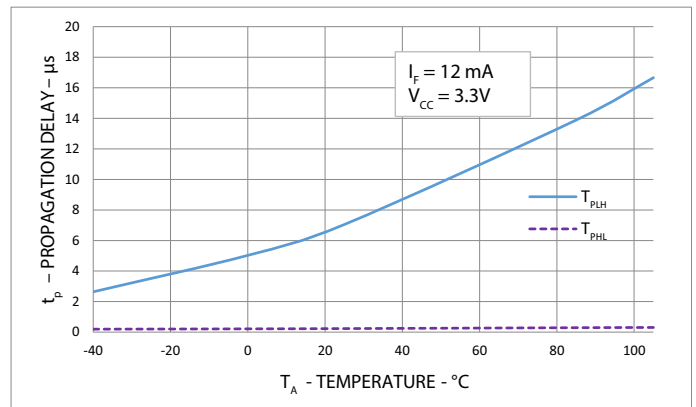

Figure 13: Typical Propagation Delay vs. Temperature

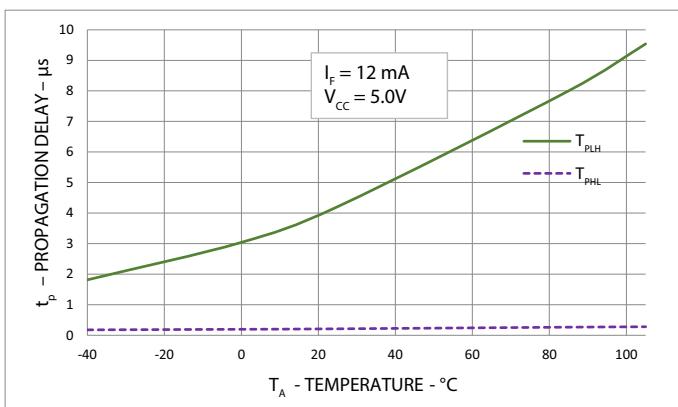

Figure 14: Switching Test Circuits

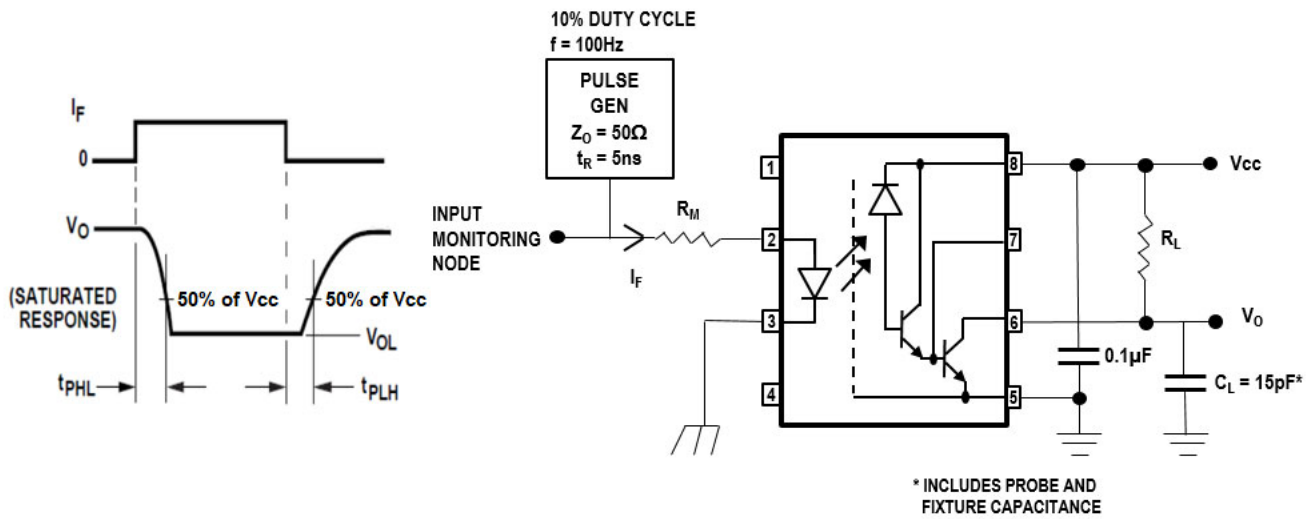

Figure 15: Test Circuit for Transient Immunity and Typical Waveforms

