

## 0.4-Amp Output Current IGBT Gate Driver Optocouplers

### Data Sheet

#### Description

The ACPL-P302/W302 consists of a GaAsP LED optically coupled to an integrated circuit with a power output stage. These optocouplers are ideally suited for driving power IGBTs and MOSFETs used in motor control inverter applications. The high operating voltage range of the output stage provides the drive voltages required by gate controlled devices. The voltage and current supplied by this optocoupler makes it ideally suited for directly driving small or medium power IGBTs.

#### Applications

- Isolated IGBT/Power MOSFET gate drive
- AC and brushless DC motor drives
- Industrial inverters
- Inverter for home appliances
- Induction cooker
- Switching Power Supplies (SPS)

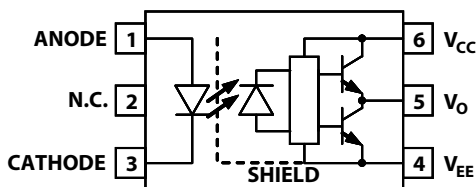

Note: A 1  $\mu$ F bypass capacitor must be connected between pins  $V_{CC}$  and  $V_{EE}$ .

#### Truth Table

LED	$V_O$
OFF	LOW
ON	HIGH

#### Features

- High speed response.
  - Ultra high CMR.
  - Bootstrappable supply current.
  - Available in Stretched SO6 package
  - Package Clearance/Creepage at 8 mm (ACPL-W302)
  - Safety Approval:
    - UL1577 recognized with 3750V<sub>RMS</sub> for 1 minute for ACPL-P302 and 5000V<sub>RMS</sub> for 1 minute for ACPL-W302.
    - CSA Approved.
    - IEC/EN/DIN EN 60747-5-5 Approved
- $V_{IORM} = 891V_{peak}$  for ACPL-P302  
 $V_{IORM} = 1140V_{peak}$  for ACPL-W302

#### Specifications

- 0.4A maximum peak output current
- 0.2A minimum peak output current
- 0.7  $\mu$ s maximum propagation delay over temperature range
- $I_{CC}$  (max.) = 3 mA maximum supply current
- 10 kV/ $\mu$ s minimum common mode rejection (CMR) at  $V_{CM} = 1000V$
- Wide  $V_{CC}$  operating range: 10V to 30V over temperature range
- Wide operating temperature range: -40°C to 100°C

**CAUTION:** It is advised that normal static precautions be taken in handling and assembly of this component to prevent damage and/or degradation which may be induced by ESD. The components featured in this data sheet are not to be used in military or aerospace applications or environments.

## Ordering Information

ACPL-P302 is UL Recognized with 3750V<sub>RMS</sub> for 1 minute per UL1577. ACPL-W302 is UL Recognized with 3750V<sub>RMS</sub> for 1 minute per UL1577.

Part Number	Option	Package	Surface Mount	Tape and Reel	UL 5000V <sub>RMS</sub> / 1 minute rating	IEC/EN/DIN EN 60747-5-5	Quantity
	RoHS Compliant						
ACPL-P302	-000E	Stretched SO-6	X				100 per tube
	-500E		X	X			1000 per reel
	-060E		X			X	100 per tube
	-560E		X	X		X	1000 per reel
ACPL-W302	-000E	Stretched SO-6	X		X		100 per tube
	-500E		X	X	X		1000 per reel
	-060E		X		X	X	100 per tube
	-560E		X	X	X	X	1000 per reel

To order, choose a part number from the part number column and combine with the desired option from the option column to form an order entry.

Example 1:

ACPL-P302-560E to order product of Stretched SO6 Surface Mount package in Tape and Reel packaging with IEC/EN/DIN EN 60747-5-5 Safety Approval in RoHS compliant.

Example 2:

ACPL-P302-000E to order product of Stretched SO6 Surface Mount package in tube packaging and RoHS compliant.

Option datasheets are available. Contact your Broadcom sales representative or authorized distributor for information.

Remarks: The notation '#XXX' is used for existing products, while (new) products launched since 15th July 2001 and RoHS compliant option will use '-XXXE'.

# Package Outline Drawing

## ACPL-P302 Stretched SO6 Package

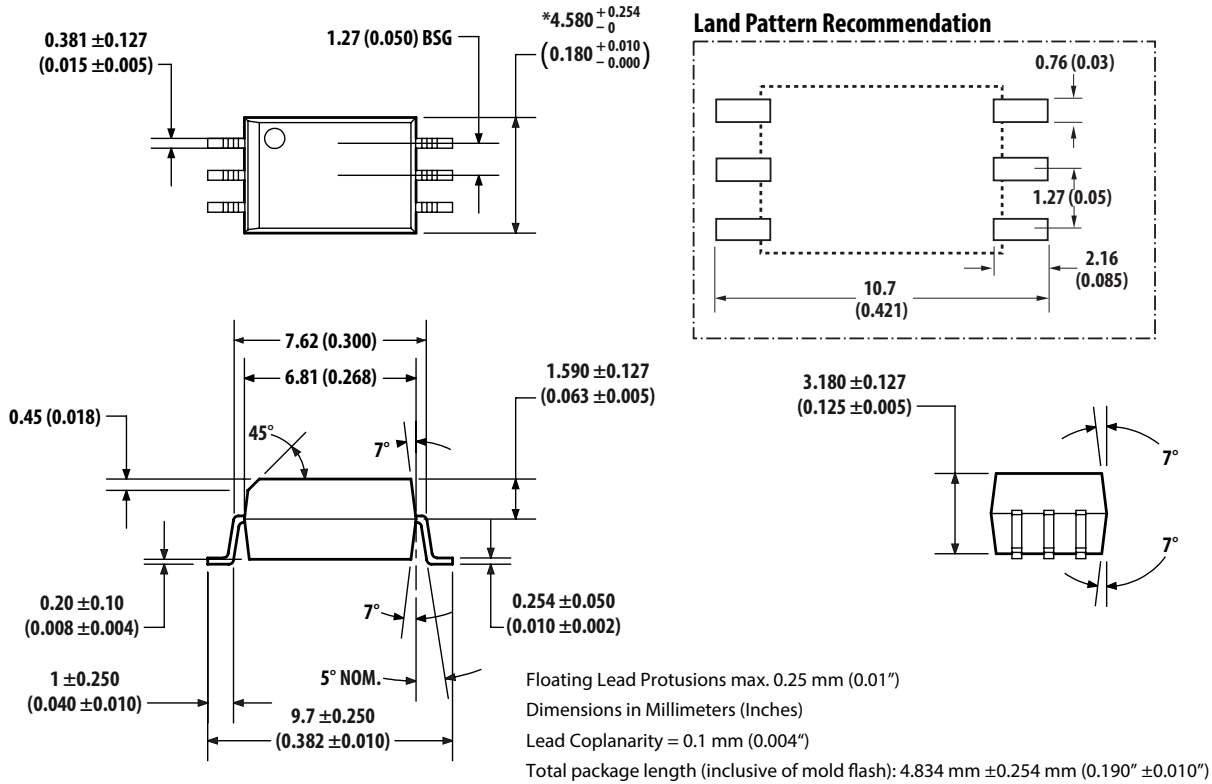

## ACPL-W302 Stretched SO6 Package

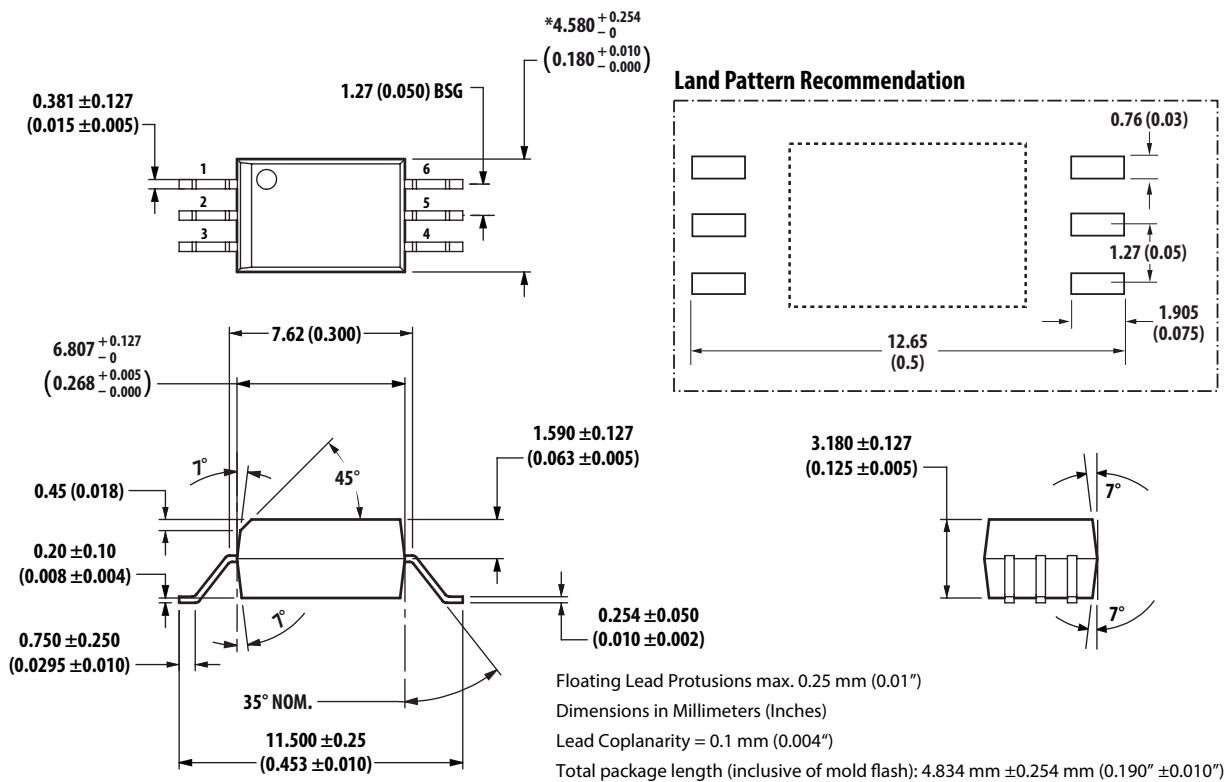

## Recommended Pb-Free IR Profile

Recommended reflow condition as per JEDEC Standard, J-STD-020 (latest revision). Non-Halide Flux should be used.

## Regulatory Information

The ACPL-P302/W302 is approved by the following organizations:

<b>UL</b>	Approval under UL 1577 component recognition program up to $V_{ISO} = 3750V_{RMS}$ for the ACPL-P302 and $V_{ISO} = 5000V_{RMS}$ for the ACPL-W302, File E55361.
<b>CSA</b>	CSA Component Acceptance Notice #5, File CA 88324
<b>IEC/EN/DIN EN 60747-5-5 (Option 060 Only)</b>	Approval under: IEC 60747-5-5:2007

## IEC/EN/DIN EN 60747-5-5 Insulation Characteristics\* (Option 060)

Description	Symbol	ACPL-W302	ACPL-P302	Unit
Installation classification per DIN VDE 0110/39, Table 1 for rated mains voltage $\leq 150V_{RMS}$ for rated mains voltage $\leq 300V_{RMS}$ for rated mains voltage $\leq 450V_{RMS}$ for rated mains voltage $\leq 600V_{RMS}$ for rated mains voltage $\leq 1000V_{RMS}$		I-IV I-IV I-IV I-IV I-III	I-IV I-IV I-III I-III	
Climatic Classification		55/100/21	55/100/21	
Pollution Degree (DIN VDE 0110/39)		2	2	
Maximum Working Insulation Voltage	$V_{IORM}$	1140	891	$V_{peak}$
Input to Output Test Voltage, Method b* $V_{IORM} \times 1.875 = V_{PR}$ , 100% Production Test with $t_m = 1$ sec, Partial discharge $< 5$ pC	$V_{PR}$	2137	1670	$V_{peak}$
Input to Output Test Voltage, Method a* $V_{IORM} \times 1.6 = V_{PR}$ , Type and Sample Test, $t_m = 10$ sec, Partial discharge $< 5$ pC	$V_{PR}$	1824	1426	$V_{peak}$
Highest Allowable Overvoltage* (Transient Overvoltage $t_{ini} = 60$ sec)	$V_{IOTM}$	8000	6000	$V_{peak}$
Safety-limiting values – maximum values allowed in the event of a failure				
Case Temperature	$T_S$	175	175	$^{\circ}C$
Input Current	$I_{S, INPUT}$	230	230	mA
Output Power	$P_{S, OUTPUT}$	600	600	mW
Insulation Resistance at $T_S$ , $V_{IO} = 500V$	$R_S$	$\leq 10^9$	$\leq 10^9$	$\Omega$

\* Refer to IEC/EN/DIN EN 60747-5-5 Optoisolator Safety Standard section of the Broadcom Regulatory Guide to Isolation Circuits, AV02-2041EN for a detailed description of Method a and Method b partial discharge test profiles.

\*\* Refer to the following figure for dependence of  $P_S$  and  $I_S$  on ambient temperature.

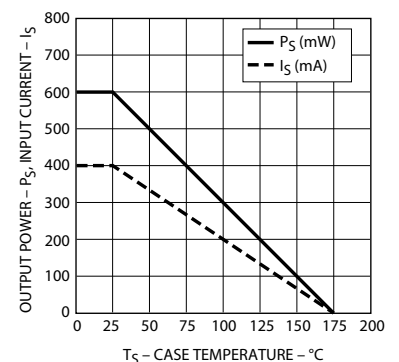

## Insulation and Safety Related Specifications

Parameter	Symbol	ACPL-P302	ACPL-W302	Unit	Conditions
Minimum External Air Gap (External Clearance)	L(101)	7.0	8.0	mm	Measured from input terminals to output terminals, shortest distance through air.
Minimum External Tracking (External Creepage)	L(102)	8.0	8.0	mm	Measured from input terminals to output terminals, shortest distance path along body.
Minimum Internal Plastic Gap (Internal Clearance)		0.08	0.08	mm	Through insulation distance conductor to conductor, usually the straight line distance thickness between the emitter and detector.
Minimum Internal Tracking (Internal Creepage)		N/A	N/A	mm	Measured from input terminals to output terminals, along internal cavity.
Tracking Resistance (Comparative Tracking Index)	CTI	>175	>175	V	DIN IEC 112/VDE 0303 Part 1
Isolation Group		IIIa	IIIa		Material Group (DIN VDE 0110, 1/89, Table 1)

Note: All Broadcom data sheets report the creepage and clearance inherent to the optocoupler component itself. These dimensions are needed as a starting point for the equipment designer when determining the circuit insulation requirements. However, once mounted on a printed circuit board, minimum creepage and clearance requirements must be met as specified for individual equipment standards. For creepage, the shortest distance path along the surface of a printed circuit board between the solder fillets of the input and output leads must be considered (the recommended Land Pattern does not necessarily meet the minimum creepage of the device). There are recommended techniques such as grooves and ribs which may be used on a printed circuit board to achieve desired creepage and clearances. Creepage and clearance distances will also change depending on factors such as pollution degree and insulation level.

## Absolute Maximum Ratings

Parameter	Symbol	Min.	Max.	Unit	Note
Storage Temperature	$T_S$	-55	+125	°C	
Operating Temperature	$T_A$	-40	+100	°C	
Average Input Current	$I_{F(AVG)}$		25	mA	1
Peak Transient Input Current (<1 $\mu$ s pulse width, 300pps)	$I_{F(TRAN)}$		1.0	A	
Reverse Input Voltage	$V_R$		5	V	
High Peak Output Current	$I_{OH(PEAK)}$		0.4	A	2
Low Peak Output Current	$I_{OL(PEAK)}$		0.4	A	2
Supply Voltage	$V_{CC} - V_{EE}$	-0.5	35	V	
Output Voltage	$V_{O(PEAK)}$	-0.5	$V_{CC}$	V	
Output Power Dissipation	$P_O$		250	mW	3
Input Power Dissipation	$P_I$		45	mW	4
Lead Solder Temperature	260°C for 10 sec., 1.6 mm below seating plane				
Solder Reflow Temperature Profile	See Package Outline Drawings section				

## Recommended Operating Conditions

Parameter	Symbol	Min.	Max.	Unit	Note
Power Supply	$V_{CC} - V_{EE}$	10	30	V	
Input Current (ON)	$I_{F(ON)}$	7	12	mA	
Input Voltage (OFF)	$V_{F(OFF)}$	-3.6	0.8	V	
Operating Temperature	$T_A$	-40	100	°C	

## Electrical Specifications (DC)

Over recommended operating conditions unless otherwise specified.

Parameter	Symbol	Min.	Typ.	Max.	Unit	Test Conditions	Fig.	Note
High Level Output Current	I <sub>OH</sub>	0.15			A	V <sub>O</sub> = V <sub>CC</sub> - 4		5
		0.2	0.3		A	V <sub>O</sub> = V <sub>CC</sub> - 10	2	2
Low Level Output Current	I <sub>OL</sub>	0.15			A	V <sub>O</sub> = V <sub>EE</sub> + 2.5		5
		0.2	0.3		A	V <sub>O</sub> = V <sub>EE</sub> + 10	4	2
High Level Output Voltage	V <sub>OH</sub>	V <sub>CC</sub> - 4	V <sub>CC</sub> - 1.8		V	I <sub>O</sub> = -100 mA	1	6, 7
Low Level Output Voltage	V <sub>OL</sub>		0.4	1	V	I <sub>O</sub> = 100 mA	3	
High Level Supply Current	I <sub>CCH</sub>		0.7	3	mA	I <sub>F</sub> = 10 mA	5, 6	15
Low Level Supply Current	I <sub>CCL</sub>		1.2	3	mA	I <sub>F</sub> = 0 mA	5, 6	15
Threshold Input Current Low to High	I <sub>FLH</sub>			6	mA	I <sub>O</sub> = 0 mA, V <sub>O</sub> > 5V	7, 13	
Threshold Input Voltage High to Low	V <sub>FHL</sub>	0.8			V	I <sub>O</sub> = 0 mA, V <sub>O</sub> > 5V		
Input Forward Voltage	V <sub>F</sub>	1.2	1.5	1.8	V	I <sub>F</sub> = 10 mA	14	
Temperature Coefficient of Input Forward Voltage	ΔV <sub>F</sub> /ΔT <sub>A</sub>		-1.6		mV/°C	I <sub>F</sub> = 10 mA		
Input Reverse Breakdown Voltage	BV <sub>R</sub>	5			V	I <sub>R</sub> = 10 μA		
Input Capacitance	C <sub>IN</sub>		60		pF	f = 1 MHz, V <sub>F</sub> = 0V		

## Switching Specifications (AC)

Over recommended operating conditions unless otherwise specified.

Parameter	Symbol	Min.	Typ.	Max.	Unit	Test Conditions	Fig.	Note
Propagation Delay Time to High Output Level	t <sub>PLH</sub>	0.1	0.2	0.7	μs	R <sub>g</sub> = 75Ω, C <sub>g</sub> = 1.5 nF, f = 10 kHz, Duty Cycle = 50%, I <sub>F</sub> = 7 mA, V <sub>CC</sub> = 30V	8, 9, 10, 11, 12, 15	14
Propagation Delay Time to Low Output Level	t <sub>PHL</sub>	0.1	0.3	0.7	μs			
Propagation Delay Difference Between Any Two Parts or Channels	PDD	-0.5		0.5	μs			
Rise Time	t <sub>R</sub>		50		ns			
Fall Time	t <sub>F</sub>		50		ns			
Output High Level Common Mode Transient Immunity	C <sub>MH</sub>	10			kV/μs	T <sub>A</sub> = 25°C, V <sub>CM</sub> = 1000V	16	12
Output Low Level Common Mode Transient Immunity	C <sub>ML</sub>	10			kV/μs			16

## Package Characteristics

Parameter	Symbol	Device	Min.	Typ.	Max.	Unit	Test Conditions	Fig.	Note
Input-Output Momentary Withstand Voltage	V <sub>ISO</sub>	ACPL-P302	3750			V <sub>rms</sub>	T <sub>A</sub> = 25°C, RH < 50% for 1 min.		8, 10
		ACPL-W302	5000						9, 10
Input-Output Resistance	R <sub>I-O</sub>			10 <sup>12</sup>			V <sub>I-O</sub> = 500V		10
Input-Output Capacitance	C <sub>I-O</sub>			0.6		pF	Freq=1 MHz		

### Notes:

- Derate linearly above 70°C free air temperature at a rate of 0.3 mA/°C.
- Maximum pulse width = 10 μs, maximum duty cycle = 0.2%. This value is intended to allow for component tolerances for designs with I<sub>O</sub> peak minimum = 0.2A. See Application section for additional details on limiting I<sub>OL</sub> peak.
- Derate linearly above 85°C, free air temperature at the rate of 4.0 mW/°C.
- Input power dissipation does not require derating.
- Maximum pulse width = 50 μs, maximum duty cycle = 0.5%.
- In this test, V<sub>OH</sub> is measured with a DC load current. When driving capacitive load V<sub>OH</sub> will approach V<sub>CC</sub> as I<sub>OH</sub> approaches zero amps.
- Maximum pulse width = 1 ms, maximum duty cycle = 20%.
- In accordance with UL 1577, each optocoupler is proof tested by applying an insulation test voltage > 4500V<sub>RMS</sub> for 1 second (leakage detection current limit I<sub>I-O</sub> < 5 μA). This test is performed before 100% production test for partial discharge (method B) shown in the IEC/EN/DIN EN 60747-5-5 Insulation Characteristics Table, if applicable.
- In accordance with UL 1577, each optocoupler is proof tested by applying an insulation test voltage > 6000V<sub>RMS</sub> for 1 second (leakage detection current limit II-O < 5A). This test is performed before 100% production test for partial discharge (method B) shown in the IEC/EN/DIN EN 60747-5-5 Insulation Characteristics Table, if applicable.
- Device considered a two-terminal device: pins on input side shorted together and pins on output side shorted together.
- PDD is the difference between t<sub>PHL</sub> and t<sub>PLH</sub> between any two parts or channels under the same test conditions.
- Common mode transient immunity in the high state is the maximum tolerable |dV<sub>CM</sub>/dt| of the common mode pulse V<sub>CM</sub> to assure that the output will remain in the high state (i.e. V<sub>O</sub> > 15.0 V).
- Common mode transient immunity in a low state is the maximum tolerable |dV<sub>CM</sub>/dt| of the common mode pulse, V<sub>CM</sub>, to assure that the output will remain in a low state (i.e. V<sub>O</sub> < 1.0 V).
- This load condition approximates the gate load of a 1200 V/20 A IGBT.
- The power supply current increases when operating frequency and Q<sub>g</sub> of the driven IGBT increases.

# Typical Performance Plots

Figure 1  $V_{OH}$  vs. Temperature

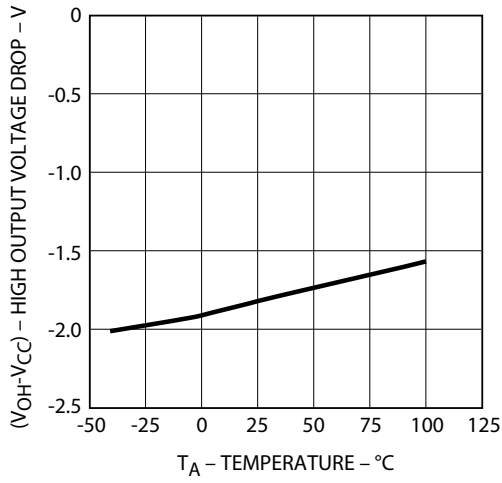

Figure 2  $V_{OH}$  vs.  $I_{OH}$

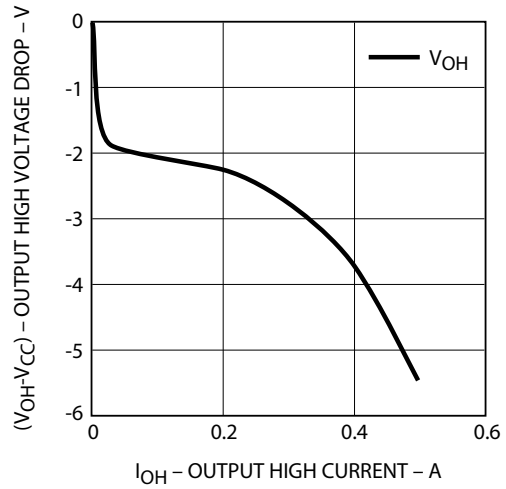

Figure 3  $V_{OL}$  vs. Temperature

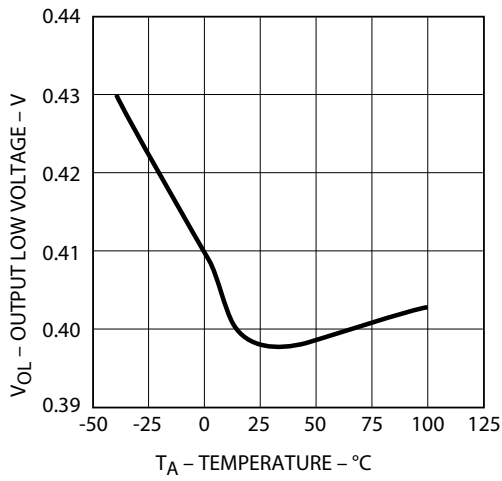

Figure 4  $V_{OL}$  vs.  $I_{OL}$

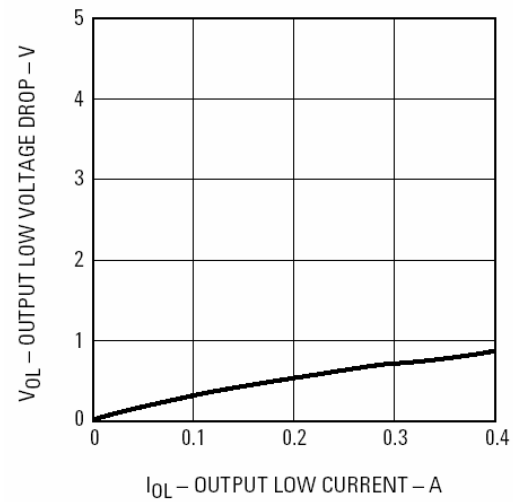

Figure 5  $I_{CC}$  vs. Temperature

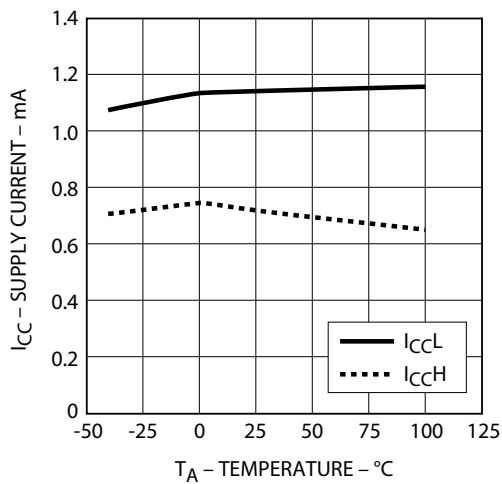
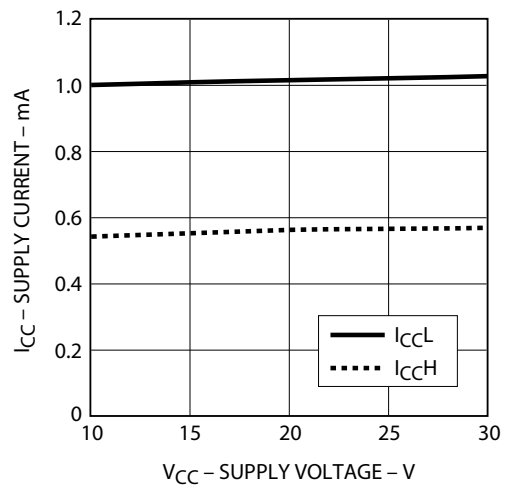
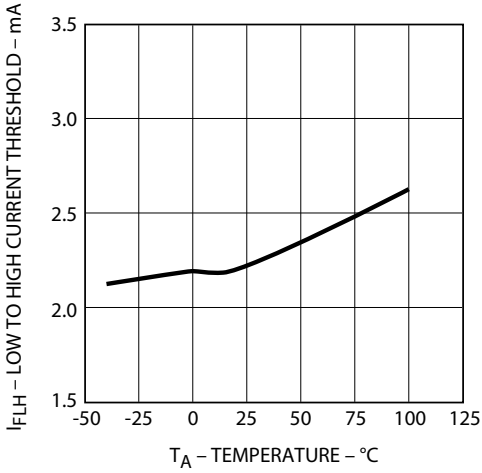

Figure 6  $I_{CC}$  vs.  $V_{CC}$

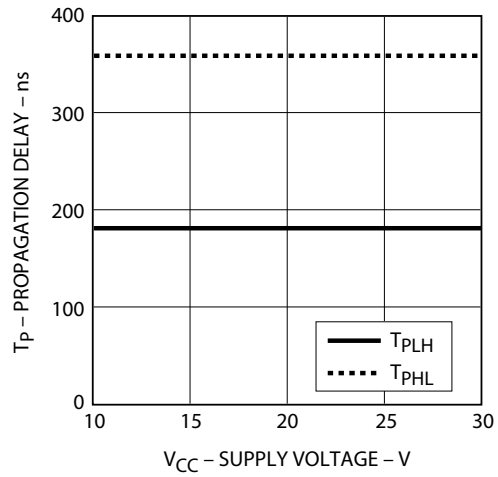



**Figure 7  $I_{FLH}$  vs. Temperature**



**Figure 8 Propagation Delay vs.  $V_{CC}$**



**Figure 9 Propagation Delay vs.  $I_F$**

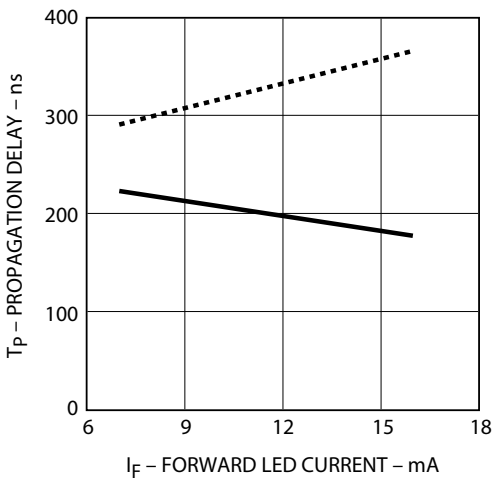

**Figure 10 Propagation Delay vs. Temperature**

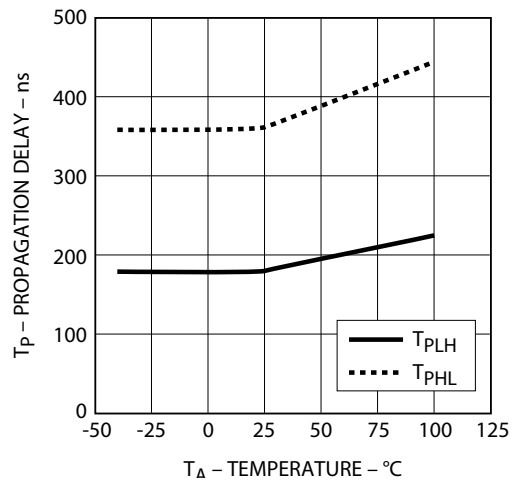

**Figure 11 Propagation Delay vs.  $R_g$**

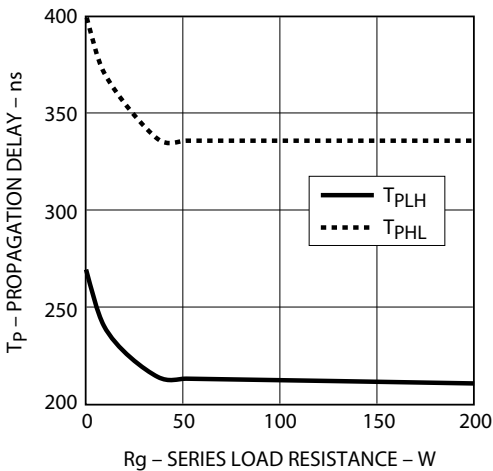

**Figure 12 Propagation Delay vs.  $C_g$**

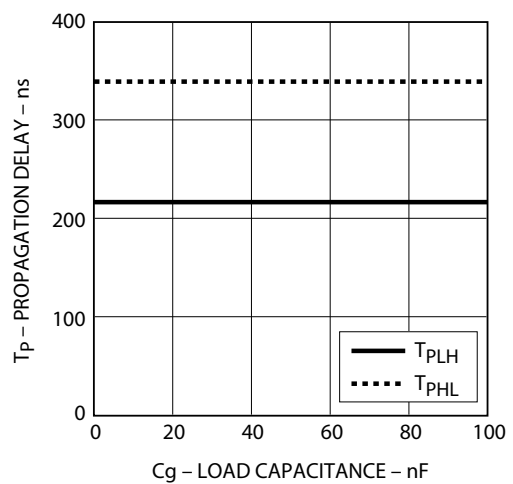

Figure 13 Transfer Characteristics

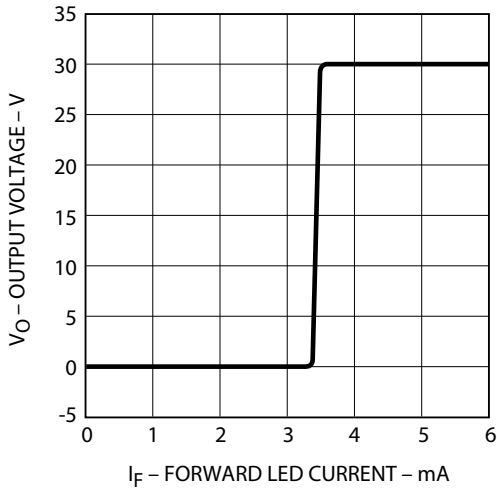

Figure 14 Input Current vs. Forward Voltage

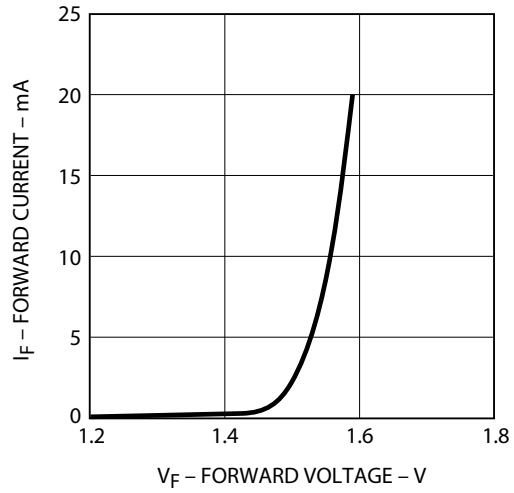

Figure 15 Propagation Delay Test Circuit and Waveforms

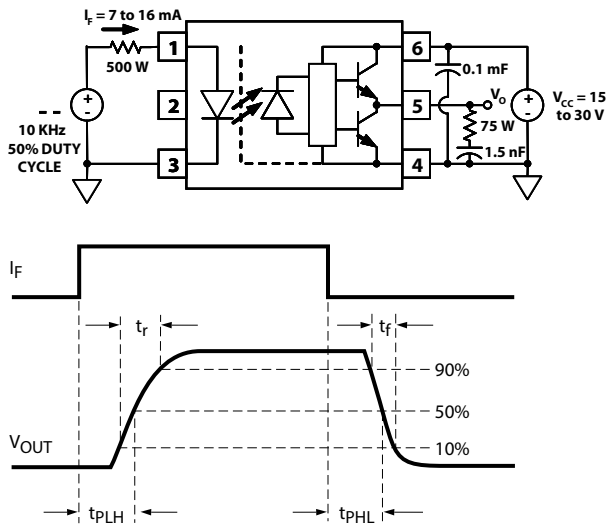
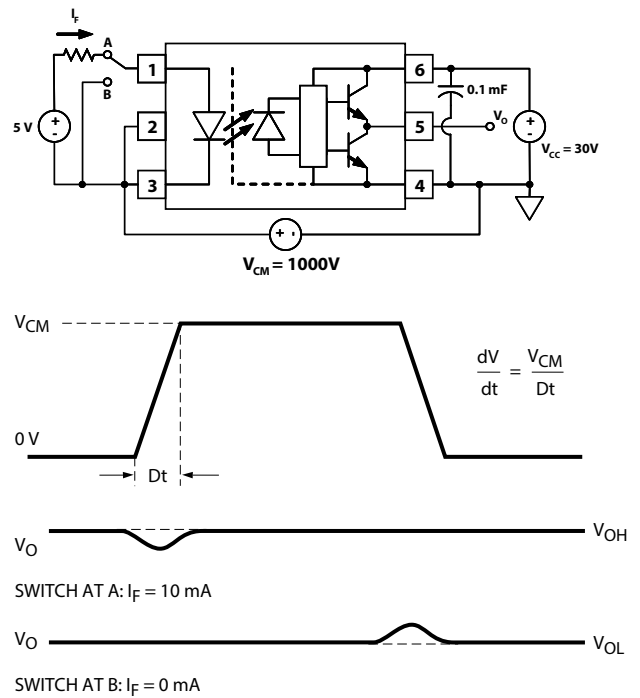

Figure 16 CMR Test Circuit and Waveforms



## Applications Information

### Eliminating Negative IGBT Gate Drive

To keep the IGBT firmly off, the ACPL-P302/W302 has a very low maximum  $V_{OL}$  specification of 1.0 V. Minimizing  $R_g$  and the lead inductance from the ACPL-P302/W302 to the IGBT gate and emitter (possibly by mounting the ACPL-P302/W302 on a small PC board directly above the IGBT) can eliminate the need for negative IGBT gate drive in many applications as shown in Figure 17. Care should be taken with such a PC board design to avoid routing the IGBT collector or emitter traces close to the ACPL-P302/W302 input as this can result in unwanted coupling of transient signals into the input of ACPL-P302/W302 and degrade performance. (If the IGBT drain must be routed near the ACPL-P302/W302 input, then the LED should be reverse biased when in the off state, to prevent the transient signals coupled from the IGBT drain from turning on the ACPL-P302/W302.

### Selecting the Gate Resistor ( $R_g$ )

Step 1: Calculate  $R_g$  minimum from the  $I_{OL}$  peak specification. The IGBT and  $R_g$  in Figure 17 can be analyzed as a simple RC circuit with a voltage supplied by the ACPL-P302/W302.

The  $V_{OL}$  value of 1 V in the previous equation is the  $V_{OL}$  at the peak current of 0.4A. (See Figure 4).

$$R_g \geq \frac{V_{CC} - V_{OL}}{I_{OLPEAK}}$$

$$= \frac{24 - 1}{0.4}$$

$$= 57.5 \Omega$$

Figure 17 Recommended LED Drive and Application Circuit for ACPL-P302/W302

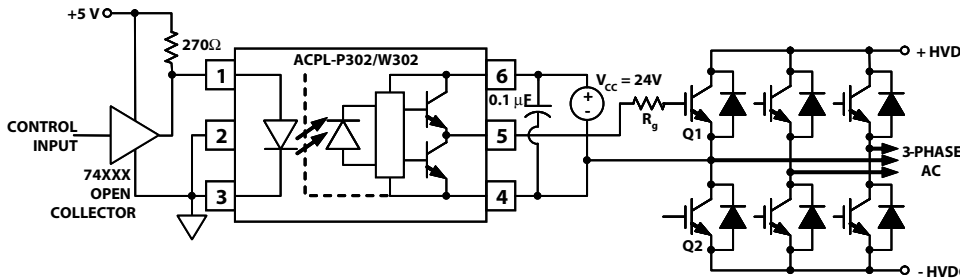
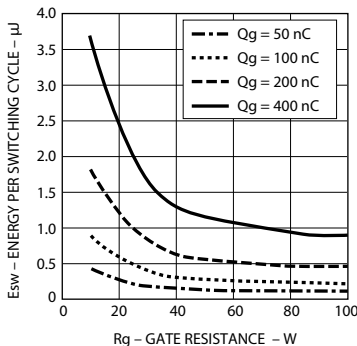

Figure 18 Energy Dissipated for Each IGBT Switching Cycle



Step 2: Check the ACPL-P302/W302 power dissipation and increase  $R_g$  if necessary. The ACPL-P302/W302 total power dissipation ( $P_T$ ) is equal to the sum of the emitter power ( $P_E$ ) and the output power ( $P_O$ ).

$$P_T = P_E + P_O$$

$$P_E = I_F \cdot V_F \cdot \text{DutyCycle}$$

$$P_O = P_{O(BIAS)} + P_{O(SWITCHING)} = I_{CC} \cdot V_{CC} + E_{SW} (R_g; Q_g) \cdot f$$

$$= (I_{CCBIAS} + K_{ICC} \cdot Q_g \cdot f) \cdot V_{CC} + E_{SW} (R_g; Q_g) \cdot f$$

where  $K_{ICC} \times Q_g \times f$  is the increase in  $I_{CC}$  due to switching and  $K_{ICC}$  is a constant of 0.001 mA/(nC\*kHz). For the circuit in Figure 17 with  $I_F$  (worst case) = 10 mA,  $R_g = 57.5\Omega$ , Max Duty Cycle = 80%,  $Q_g = 100$  nC,  $f = 20$  kHz and  $T_{AMAX} = 85^\circ\text{C}$ :

$$P_E = 10 \text{ mA} \cdot 1.8\text{V} \cdot 0.8 = 14 \text{ mW}$$

$$P_O = (3 \text{ mA} + (0.001 \text{ mA/nC} \cdot \text{kHz}) \cdot 20 \text{ kHz} \cdot 100 \text{ nC}) \cdot 24\text{V} + 0.3 \mu\text{J} \cdot 20 \text{ kHz} = 126 \text{ mW} \pm 250 \text{ mW} (P_{O(MAX)} @ 85^\circ\text{C})$$

The value of 3 mA for  $I_{CC}$  in the previous equation is the max.  $I_{CC}$  over entire operating temperature range.

Since  $P_O$  for this case is less than  $P_{O(MAX)}$ ,  $R_g = 57.5\Omega$  is alright for the power dissipation.

## LED Drive Circuit Considerations for Ultra High CMR Performance

Without a detector shield, the dominant cause of optocoupler CMR failure is capacitive coupling from the input side of the optocoupler, through the package, to the detector IC as shown in Figure 19. The ACPL-P302/W302 improves CMR performance by using a detector IC with an optically transparent Faraday shield, which diverts the capacitively coupled current away from the sensitive IC circuitry. However, this shield does not eliminate the capacitive coupling between the LED and optocoupler pins 5-8 as shown in Figure 20. This capacitive coupling causes perturbations in the LED current during common mode transients and becomes the major source of CMR failures for a shielded optocoupler. The main design objective of a high CMR LED drive circuit becomes keeping the LED in the proper state (on or off) during common mode transients. For example, the recommended application circuit (Figure 17), can achieve 10 kV/μs CMR while minimizing component complexity.

Techniques to keep the LED in the proper state are discussed in the next two sections.

**Figure 19 Optocoupler Input to Output Capacitance Model for Unshielded Optocouplers**

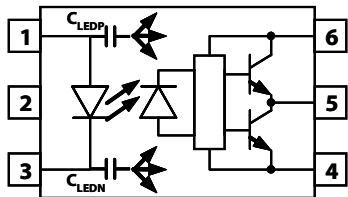

**Figure 20 Optocoupler Input to Output Capacitance Model for Shielded Optocouplers**

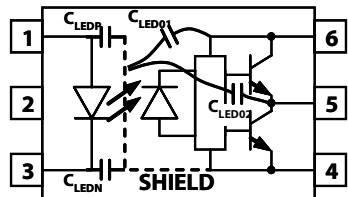

## CMR with the LED On (CMR<sub>H</sub>)

A high CMR LED drive circuit must keep the LED on during common mode transients. This is achieved by overdriving the LED current beyond the input threshold so that it is not pulled below the threshold during a transient. A minimum LED current of 7 mA provides adequate margin over the maximum I<sub>FLH</sub> of 5 mA to achieve 10 kV/μs CMR.

## CMR with the LED Off (CMR<sub>L</sub>)

A high CMR LED drive circuit must keep the LED off ( $V_F \leq V_{F(OFF)}$ ) during common mode transients. For example, during a  $-dV_{CM}/dt$  transient in Figure 21, the current flowing through C<sub>LEDP</sub> also flows through the R<sub>SAT</sub> and V<sub>SAT</sub> of the logic gate. As long as the low state voltage developed across the logic gate is less than V<sub>F(OFF)</sub> the LED will remain off and no common mode failure will occur.

**Figure 21 Equivalent Circuit for Figure 15 During CM Transient**

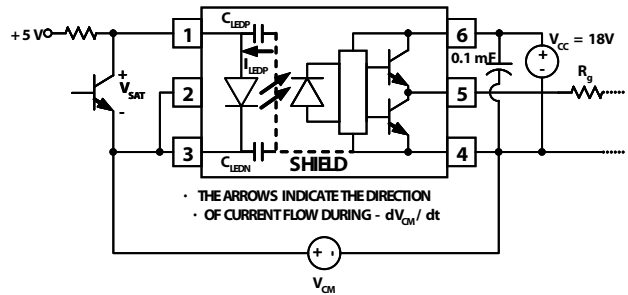

The open collector drive circuit, shown in Figure 22, can not keep the LED off during a  $+dV_{CM}/dt$  transient, since all the current flowing through C<sub>LEDN</sub> must be supplied by the LED, and it is not recommended for applications requiring ultra high CMR<sub>L</sub> performance. The alternative drive circuit which like the recommended application circuit (Figure 17), does achieve ultra high CMR performance by shunting the LED in the off state.

**Figure 22 Not Recommended Open Collector Drive Circuit**

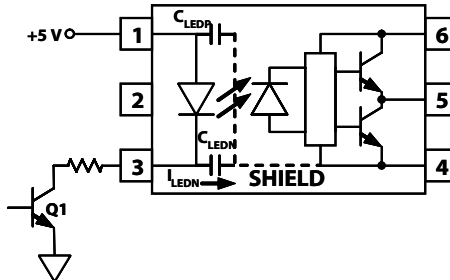

**Figure 23 Recommended LED Drive Circuit for Ultra-High CMR Dead Time and Propagation Delay Specifications**

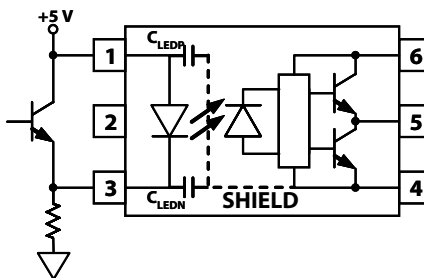

## Dead Time and Propagation Delay Specifications

The ACPL-P302/W302 includes a Propagation Delay Difference (PDD) specification intended to help designers minimize “dead time” in their power inverter designs. Dead time is the time high and low side power transistors are off. Any overlap in Q1 and Q2 conduction will result in large currents flowing through the power devices from the high voltage to the low-voltage motor rails. To minimize dead time in a given design, the turn on of LED2 should be delayed (relative to the turn off of LED1) so that under worst-case conditions, transistor Q1 has just turned off when transistor Q2 turns on, as shown in Figure 24. The amount of delay necessary to achieve this condition is equal to the maximum value of the propagation delay difference specification, PDD max, which is specified to be 500 ns over the operating temperature range of -40° to 100°C.

**Figure 24 Minimum LED Skew for Zero Dead Time**

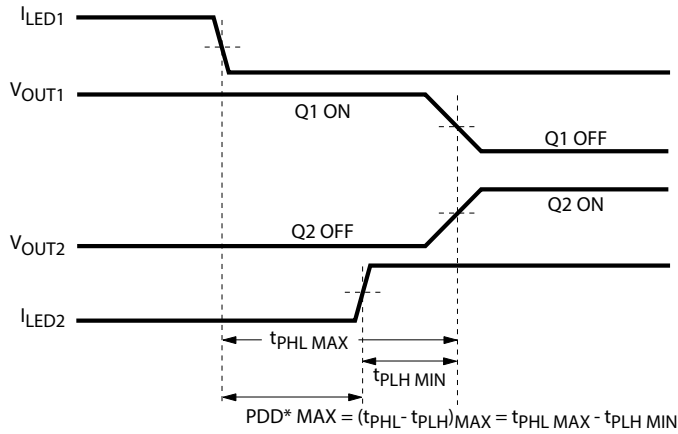

\*PDD = PROPAGATION DELAY DIFFERENCE  
 NOTE: FOR PDD CALCULATIONS THE PROPAGATION DELAYS ARE TAKEN AT THE SAME TEMPERATURE AND TEST CONDITIONS.

Delaying the LED signal by the maximum propagation delay difference ensures that the minimum dead time is zero, but it does not tell a designer what the maximum dead time will be. The maximum dead time is equivalent to the difference between the maximum and minimum propagation delay difference specification as shown in Figure 25. The maximum dead time for the ACPL-P302/W302 is 1 μs (= 0.5 μs - (-0.5 μs)) over the operating temperature range of -40°C to 100°C.

**Figure 25 Waveforms for Dead Time**

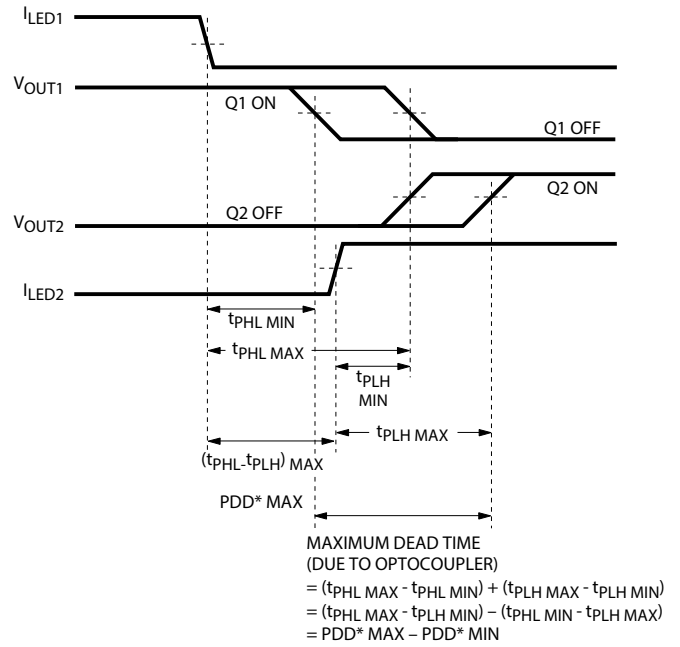

Note that the propagation delays used to calculate PDD and dead time are taken at equal temperatures and test conditions since the optocouplers under consideration are typically mounted in close proximity to each other and are switching identical IGBTs.

## Thermal Model for ACPL-P302/W302 Stretched-SO6 Package Optocoupler

### Definitions

- $R_{11}$ : Junction to Ambient Thermal Resistance of LED due to heating of LED
- $R_{12}$ : Junction to Ambient Thermal Resistance of LED due to heating of Detector (Output IC)
- $R_{21}$ : Junction to Ambient Thermal Resistance of Detector (Output IC) due to heating of LED.
- $R_{22}$ : Junction to Ambient Thermal Resistance of Detector (Output IC) due to heating of Detector (Output IC).
- $P_1$ : Power dissipation of LED (W).
- $P_2$ : Power dissipation of Detector / Output IC (W).
- $T_1$ : Junction temperature of LED (°C).
- $T_2$ : Junction temperature of Detector (°C).
- $T_a$ : Ambient temperature.
- $\Delta T_1$ : Temperature difference between LED junction and ambient (°C).
- $\Delta T_2$ : Temperature difference between Detector junction and ambient.

Ambient Temperature: Junction to Ambient Thermal Resistances were measured approximately 1.25 cm above optocoupler at ~23°C in still air.

### Description

This thermal model assumes that an 6-pin single-channel plastic package optocoupler is soldered into a 7.62 cm x 7.62 cm printed circuit board (PCB). The temperature at the LED and Detector junctions of the optocoupler can be calculated using the equations below.

$$T_1 = (R_{11} \times P_1 + R_{12} \times P_2) + T_a \quad -- (1)$$

$$T_2 = (R_{21} \times P_1 + R_{22} \times P_2) + T_a \quad -- (2)$$

Jedec Specifications	$R_{11}$	$R_{12}, R_{21}$	$R_{22}$
low K board	357	150, 166	228
high K board	249	76, 79	159

Notes:

1. Maximum junction temperature for above parts: 125 °C.