

ACPL-P480 and ACPL-W480

High CMR Intelligent Power Module and Gate Drive Interface Optocoupler

Description

The Broadcom® high-speed ACPL-P480/W480 optocoupler contains a GaAsP LED, a photo detector, and a Schmitt trigger that eliminates the requirement for external waveform conditioning circuits. The totem pole output eliminates the need for a pull-up resistor and allows for a direct-drive Intelligent Power Module or gate drive. Propagation delay difference between devices has been minimized to maximize inverter efficiency through reduced switching dead time.

Applications

- IPM interface isolation
- Isolated IGBT/MOSFET gate drive
- AC and brushless DC motor drives
- Industrial inverters
- General digital isolation

Functional Diagram

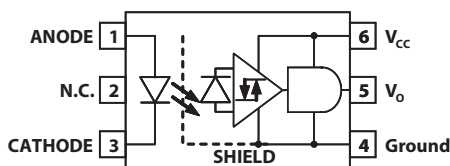

NOTE: A 0.1- μ F bypass capacitor must be connected between pins 4 and 6.

Truth Table (Non-Inverting Logic)

LED	V _O
ON	HIGH
OFF	LOW

Features

- Performance specified for common IPM applications over industrial temperature range
- Short maximum propagation delays
- Minimized pulse width distortion (PWD)
- Very high common mode rejection (CMR)
- Hysteresis
- Totem pole output (no pull-up resistor required)
- Available in stretched SO-6 package
- Package clearance/creepage at 8 mm (ACPL-W480)
- Safety approvals:
 - UL recognized with 3750V_{RMS} for 1 minute (5000V_{RMS} for 1 minute for all ACPL-W480 devices and Option 020 device for ACPL-P480) per UL1577
 - CSA approved
 - IEC/EN/DIN EN 60747-5-5 approved with V_{IORM} = 891V_{peak} for ACPL-P480 and V_{IORM} = 1140V_{peak} for ACPL-W480

Specifications

- Wide operating temperature range: -40°C to 100°C
- Maximum propagation delay t_{PHL}/t_{PLH} = 350 ns
- Maximum pulse width distortion (PWD) = 250 ns
- Propagation delay difference: minimum -100 ns, maximum - 250 ns
- Wide operating V_{CC} range: 4.5V to 20V
- 20 kV/ μ s minimum common mode rejection (CMR) at V_{CM} = 1000V

CAUTION! It is advised that normal static precautions be taken in handling and assembly of this component to prevent damage and/or degradation which may be induced by ESD.

Ordering Information

ACPL-P480 is UL Recognized with 3750V_{RMS} for 1 minute and ACPL-W480 is UL Recognized with 5000V_{RMS} for 1 minute per UL1577. Both are approved under CSA Component Acceptance Notice #5, File CA 88324.

Part Number	Option	Package	Surface Mount	Tape and Reel	IEC/EN/DIN EN 60747-5-5	Quantity	
	RoHS Compliant						
ACPL-P480	-000E	7 mm Stretched SO-6	X			100 per tube	
	-500E		X	X		1000 per tube	
	-020E		X			100 per tube	
	-520E		X	X		1000 per tube	
	-060E		X			X	100 per tube
	-560E		X	X		X	1000 per tube
ACPL-W480	-000E	8 mm Stretched SO-6	X			100 per tube	
	-500E		X	X		1000 per tube	
	-060E		X			X	100 per tube
	-560E		X	X		X	1000 per tube

To order, choose a part number from the part number column and combine with the desired option from the option column to form an ordering part number.

Example 1:

ACPL-P480-560E to order product of Stretched SO-6 package in Tape and Reel packaging with IEC/EN/DIN EN 60747-5-5 Safety Approval in RoHS compliant.

Example 2:

ACPL-P480-000E to order product of Stretched SO-6 package in tube packaging and RoHS compliant.

Option data sheets are available. Contact your Broadcom sales representative or authorized distributor for information.

Solder Reflow Profile

The recommended reflow profile is per JEDEC Standard, J-STD-020 (latest revision). Non-halide flux should be used.

Regulatory Information

The ACPL-P480 and ACPL-W480 are approved by the following organizations:

- IEC/EN/DIN EN 60747-5-5 (Option 060 only):
 - IEC 60747-5-5: 2007
 - EN 60747-5-5: 2011
 - DIN EN 60747-5-5 (VDE 0884-5): 2011-11
- UL:
 - ACPL-P480: Approval under UL 1577, component recognition program up to $V_{ISO} = 3750V_{RMS}$. File E55361.
 - ACPL-W480 and ACPL-P480 (option 020): Approval under UL 1577, component recognition program up to $V_{ISO} = 5000V_{RMS}$. File E55361.
- CSA: Approval under CSA Component Acceptance Notice #5, File CA 88324.

Package Outline Drawings

ACPL-P480 Stretched SO-6 Package (7 mm Clearance)

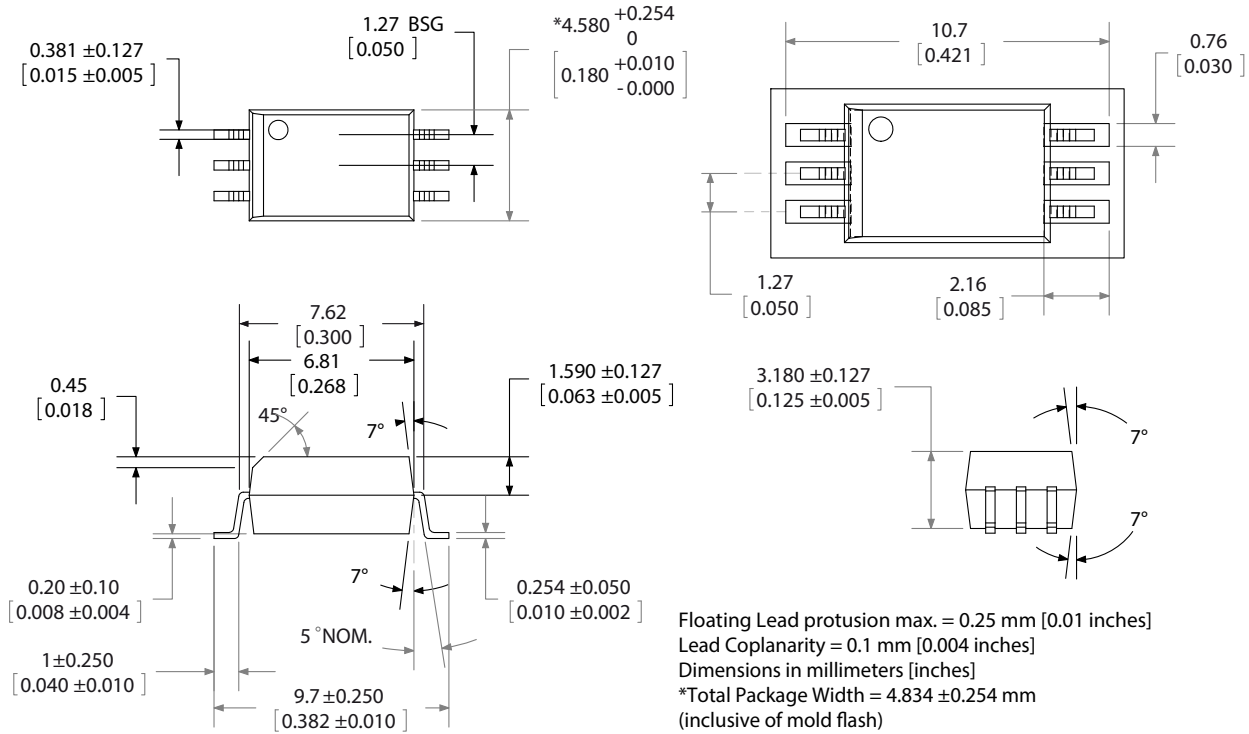

ACPL-W480 Stretched SO-6 Package (8 mm Clearance)

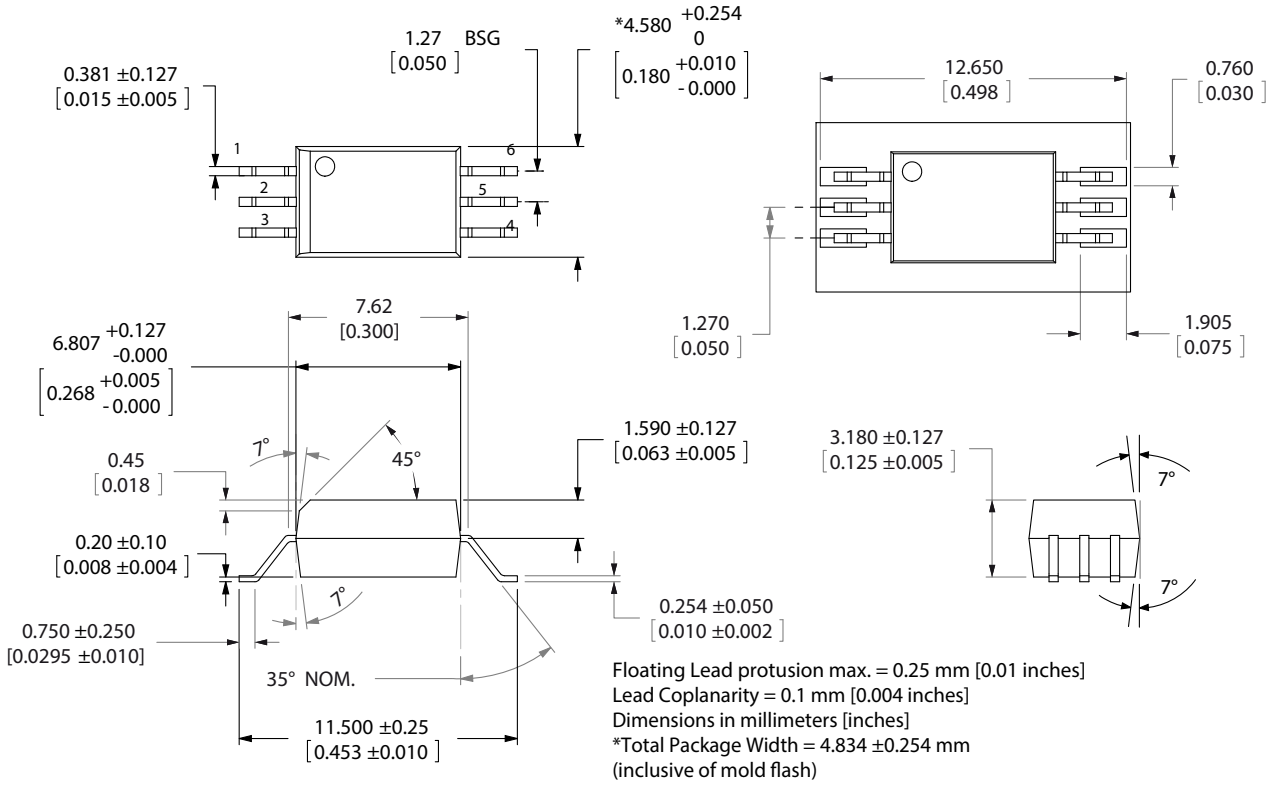

IEC/EN/DIN EN 60747-5-5 Insulation Characteristics (Option 060)

Description	Symbol	ACPL-P480	ACPL-W480	Units
Installation Classification per DIN VDE 0110/39, Table 1 for rated mains voltage $\leq 150V_{RMS}$ for rated mains voltage $\leq 300V_{RMS}$ for rated mains voltage $\leq 600V_{RMS}$		I – IV I – IV I – III	I – IV I – IV I – IV	
Climatic Classification		55/100/21		
Pollution Degree (DIN VDE 0110/39)		2		
Maximum Working Insulation Voltage	V_{IORM}	891	1140	V_{peak}
Input to Output Test Voltage, Method b ^a $V_{IORM} \times 1.875 = V_{PR}$, 100% Production Test with $t_m = 1$ sec, Partial Discharge < 5 pC	V_{PR}	1670	2137	V_{peak}
Input to Output Test Voltage, Method a ^a $V_{IORM} \times 1.6 = V_{PR}$, Type and Sample Test, $t_m = 10s$, Partial Discharge < 5 pC	V_{PR}	1426	1824	V_{peak}
Highest Allowable Overvoltage (Transient Overvoltage $t_{ni} = 60s$)	V_{IOTM}	6000	8000	V_{peak}
Safety-limiting Values – maximum values allowed in the event of a failure				
Case Temperature	T_S		175	$^{\circ}C$
Input Current	$I_{S, INPUT}$		230	mA
Output Power	$P_{S, OUTPUT}$		600	mW
Insulation Resistance at $T_S, V_{IO} = 500V$	R_S		$>10^9$	Ω

a. Refer to the optocoupler section of the Isolation and Control Components Designer's Catalog, under the Product Safety Regulations section, (IEC/EN/DIN EN 60747-5-5), for a detailed description of Method a and Method b partial discharge test profiles.

Insulation and Safety Related Specifications

Parameter	Symbol	ACPL-P480	ACPL-W480	Unit	Condition
Minimum External Air Gap (External Clearance)	L(101)	7.0	8.0	mm	Measured from input terminals to output terminals, shortest distance through air.
Minimum External Tracking (External Creepage)	L(102)	8.0	8.0	mm	Measured from input terminals to output terminals, shortest distance path along body.
Minimum Internal Plastic Gap (Internal Clearance)		0.08		mm	Through insulation distance conductor to conductor, usually the straight line distance thickness between the emitter and detector.
Minimum Internal Tracking (Internal Creepage)		N/A		mm	Measured from input terminals to output terminals, along internal cavity.
Tracking Resistance (Comparative Tracking Index)	CTI	>175		V	DIN IEC 112/VDE 0303 Part 1.
Isolation Group		IIIa			Material Group (DIN VDE 0110, 1/89, Table 1).

UL 1577 Specification Sheet

Model	Package Type	Current, mA		Power, mW		Isolation Voltage 1 min, V _{RMS}	Maximum Operating Temperature, °C	Maximum Junction Temperature, °C	Maximum Storage Temperature, °C
		Emitter	Sensor	Emitter	Sensor				
P480	3	10	25	15	560	5000	110	125	125

Absolute Maximum Ratings

Parameter	Symbol	Min.	Max.	Units
Storage Temperature	T _S	-55	+125	°C
Operating Temperature	T _A	-40	+100	°C
Average Input Current	I _{F(AVG)}	—	10	mA
Peak Transient Input Current (<1 μs pulse width, 300 pps) (<200 μs pulse width, <1% duty cycle)	I _{F(TRAN)}	—	1.0 40	A mA
Reverse Input Voltage	V _R	—	5	V
Average Output Current	I _O	—	25	mA
Supply Voltage	V _{CC}	0	25	V
Output Voltage	V _O	-0.5	+25	V
Total Package Power Dissipation ^a	P _T	—	210	mW

a. Derate total package power dissipation, P_T, linearly above 70°C free-air temperature at a rate of 4.5 mW/°C.

Recommended Operating Conditions

Parameter	Symbol	Min.	Max.	Units	Note
Power Supply Voltage	V _{CC}	4.5	20	V	
Forward Input Current (ON)	I _{F(ON)}	6	10	mA	
Forward Input Voltage (OFF)	V _{F(OFF)}	—	0.8	V	
Operating Temperature	T _A	-40	+100	°C	

Electrical Specifications

Over recommended operating conditions $T_A = -40^\circ\text{C}$ to $+100^\circ\text{C}$, $V_{CC} = +4.5\text{V}$ to 20V , $I_{F(\text{ON})} = 6\text{ mA}$ to 10 mA , $V_{F(\text{OFF})} = 0\text{V}$ to 0.8V , unless otherwise specified. All typicals at $T_A = 25^\circ\text{C}$.

Parameter	Symbol	Min.	Typ.	Max.	Units	Test Conditions	Figure	Note
Logic Low Output Voltage	V_{OL}	—	—	0.5	V	$I_{OL} = 6.4\text{ mA}$	1, 3, 9, 10	
Logic High Output Voltage	V_{OH}	2.4	$V_{CC} - 1.1$	—	V	$I_{OH} = -2.6\text{ mA}$	2, 3, 7, 9, 10	
ACPL-P480		2.7				$I_{OH} = -0.4\text{ mA}$		
ACPL-W480		2.7				$I_{OH} = -1.6\text{ mA}$		
Threshold Input Current Low to High		—	2.2	5.5	mA			
Output Leakage Current ($V_O = V_{CC} + 0.5\text{V}$)	I_{OHH}	—	—	100	μA	$V_{CC} = 5\text{V}$, $I_F = 10\text{ mA}$		
		—	—	500	μA	$V_{CC} = 20\text{V}$, $I_F = 10\text{ mA}$		
Logic Low Supply Current	I_{CCL}	—	1.9	3.0	mA	$V_{CC} = 5.5\text{V}$, $V_F = 0\text{V}$, $I_O = \text{Open}$		
		—	2.0	3.0	mA	$V_{CC} = 20\text{V}$, $V_F = 0\text{V}$, $I_O = \text{Open}$		
Logic High Supply Current	I_{CCH}	—	1.5	2.5	mA	$V_{CC} = 5.5\text{V}$, $I_F = 10\text{ mA}$, $I_O = \text{Open}$		
		—	1.6	2.5	mA	$V_{CC} = 20\text{V}$, $I_F = 10\text{ mA}$, $I_O = \text{Open}$		
Logic Low Short Circuit Output Current	I_{OSL}	25	—	—	mA	$V_O = V_{CC} = 5.5\text{V}$, $V_F = 0\text{V}$		a
		50	—	—	mA	$V_O = V_{CC} = 20\text{V}$, $V_F = 0\text{V}$		
Logic High Short Circuit Output Current	I_{OSH}	—	—	-25	mA	$V_{CC} = 5.5\text{V}$, $I_F = 10\text{ mA}$, $I_O = \text{Open}$		a
		—	—	-50	mA	$V_{CC} = 20\text{V}$, $I_F = 10\text{ mA}$, $I_O = \text{Open}$		
Input Forward Voltage	V_F	—	1.5	1.7	V	$T_A = 25^\circ\text{C}$, $I_F = 6\text{ mA}$	4	
		—	—	1.85	V	$I_F = 6\text{ mA}$		
Input Reverse Breakdown Voltage	BV_R	5	—	—	V	$I_R = 10\text{ }\mu\text{A}$		
Input Diode Temperature Coefficient	$\Delta V_F/\Delta T_A$	—	1.7	—	mV/ $^\circ\text{C}$	$I_F = 6\text{ mA}$		
Input Capacitance	C_{IN}	—	60	—	pF	$f = 1\text{ MHz}$, $V_F = 0\text{V}$		b

a. Duration of output short circuit time should not exceed 10 ms.

b. Input capacitance is measured between pin 1 and pin 3.

Switching Specifications

Over recommended operating conditions $T_A = -40^\circ\text{C}$ to $+100^\circ\text{C}$, $V_{CC} = +4.5\text{V}$ to 20V , $I_{F(ON)} = 6\text{ mA}$ to 10 mA , $V_{F(OFF)} = 0\text{V}$ to 0.8V , unless otherwise specified. All typicals at $T_A = 25^\circ\text{C}$.

Parameter	Symbol	Min.	Typ.	Max.	Units	Test Conditions	Figure	Note
Propagation Delay Time to Logic Low Output Level	t_{PHL}	—	150	350	ns	with Peaking Capacitor	5, 6	a
Propagation Delay Time to Logic High Output Level	t_{PLH}	—	110	350	ns	with Peaking Capacitor	5, 6	a
Pulse Width Distortion	$ t_{PHL} - t_{PLH} = \text{PWD}$	—	—	250	ns			b
Propagation Delay Difference Between Any Two Parts	PDD	-100	—	+250	ns			c
Output Rise Time (10% to 90%)	t_r	—	16	—	ns		5, 8	
Output Fall Time (90% to 10%)	t_f	—	20	—	ns		5, 8	
Logic High Common Mode Transient Immunity	$ CM_H $	20	—	—	kV/ μs	$ V_{CM} = 1000\text{V}$, $I_F = 6.0\text{ mA}$ $V_{CC} = 5\text{V}$, $T_A = 25^\circ\text{C}$	11	d
Logic Low Common Mode Transient Immunity	$ CM_L $	20	—	—	kV/ μs	$ V_{CM} = 1000\text{V}$, $V_F = 0\text{V}$, $V_{CC} = 5\text{V}$, $T_A = 25^\circ\text{C}$	11	d

- The t_{PLH} propagation delay is measured from the 50% point on the leading edge of the input pulse to the 1.3V point on the leading edge of the output pulse. The t_{PHL} propagation delay is measured from the 50% point on the trailing edge of the input pulse to the 1.3V point on the trailing edge of the output pulse.
- Pulse Width Distortion (PWD) is defined as $|t_{PHL} - t_{PLH}|$ for any given device.
- The difference between t_{PLH} and t_{PHL} between any two devices under the same test condition.
- CM_H is the maximum slew rate of the common mode voltage that can be sustained with the output voltage in the logic high state, $V_O > 2.0\text{V}$. CM_L is the maximum slew rate of the common mode voltage that can be sustained with the output voltage in the logic low state, $V_O < 0.8\text{V}$.

Package Characteristics

Parameter	Symbol	Min.	Typ.	Max.	Units	Test Conditions	Figure	Note
Input-Output Momentary Withstand Voltage ^a	V_{ISO}	3750 ^b 5000 ^c			V_{RMS}	$RH < 50\%$, $t = 1\text{ min.}$ $T_A = 25^\circ\text{C}$		d, e
Input-Output Resistance	R_{I-O}		10^{12}			$V_{I-O} = 500V_{DC}$		d
Input-Output Capacitance	C_{I-O}		0.6			$f = 1\text{ MHz}$, $V_{I-O} = 0V_{DC}$		d, f

- The Input-Output Momentary Withstand Voltage is a dielectric voltage rating that should not be interpreted as an input-output continuous voltage rating. For the continuous voltage rating refer to the IEC/EN/DIN EN 60747-5-5 Insulation Characteristics Table (if applicable).
- For all ACPL-P480 devices except Option 020.
- For ACPL-W480 and Option 020 of ACPL-P480).
- The device is considered a two-terminal device: pins 1, 2, and 3 shorted together and pins 4, 5, and 6 shorted together.
- In accordance with UL 1577, each optocoupler is proof tested by applying an insulation test voltage $4500V_{RMS}$ for one second (leakage detection current limit, $I_{I-O} \leq 5\text{ }\mu\text{A}$); each optocoupler with option 020 is proof tested by applying an insulation test voltage $6000V_{RMS}$ for 1 second (leakage detection current limit, $I_{I-O} \leq 5\text{ }\mu\text{A}$). This test is performed before the 100% production test for partial discharge (Method b) shown in the IEC/EN/DIN EN 60747-5-2 Insulation Characteristics Table, if applicable.
- Use of a $0.1\text{ }\mu\text{F}$ bypass capacitor connected between pins 4 and 6 is recommended.

Figure 1: Typical Logic Low Output Voltage vs. Temperature

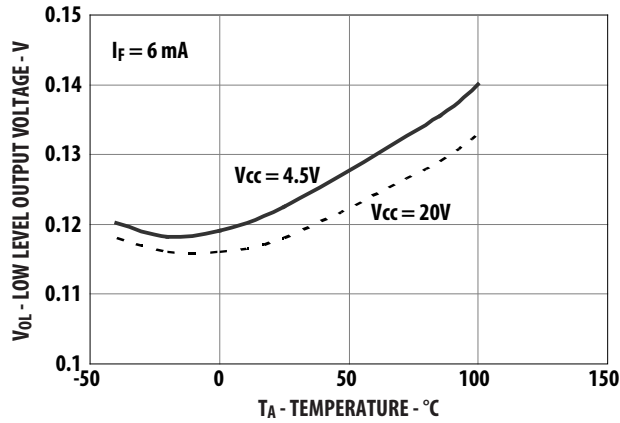

Figure 2: Typical Logic High Output Current vs. Temperature

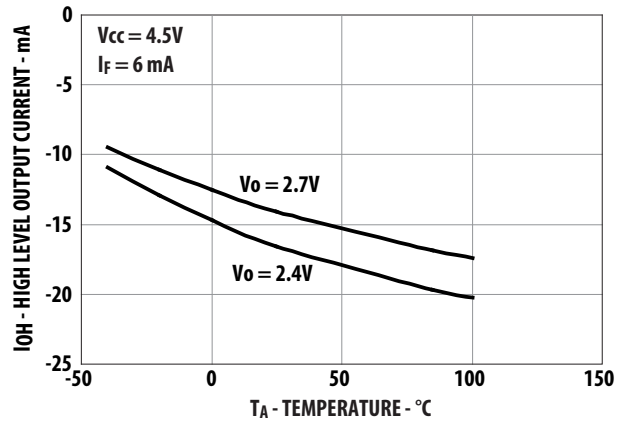

Figure 3: Typical Output Voltage vs. Forward Input Current

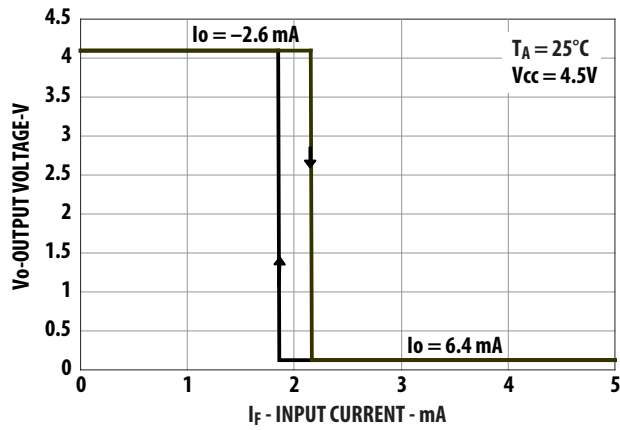

Figure 4: Typical Input Diode Forward Characteristic

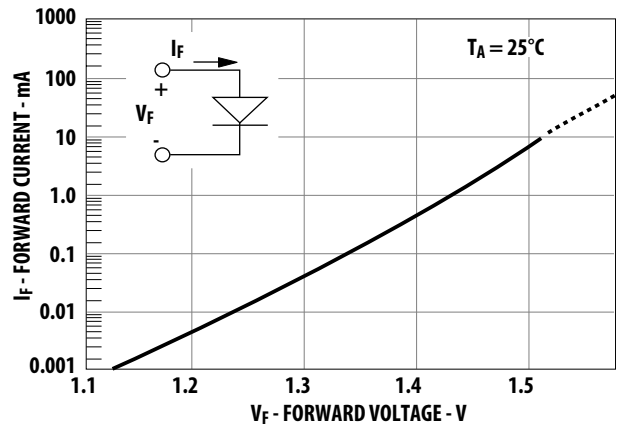
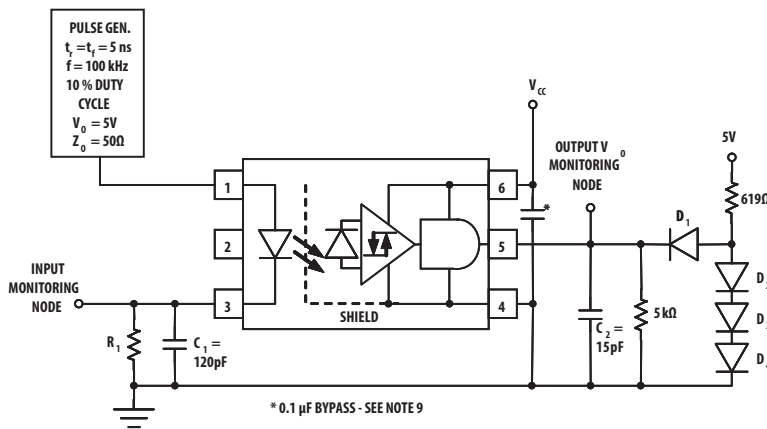

Figure 5: Test Circuit for t_{PLH} , t_{PHL} , t_r , and t_f



THE PROBE AND JIG CAPACITANCES ARE INCLUDED IN C_1 AND C_2 .

R_1	580Ω	330Ω
$I_{F(ON)}$	6 mA	10 mA

ALL DIODES ARE 1N916 OR 1N3064.

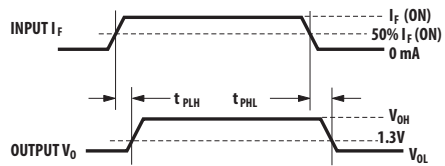

Figure 6: Typical Propagation Delays vs. Temperature

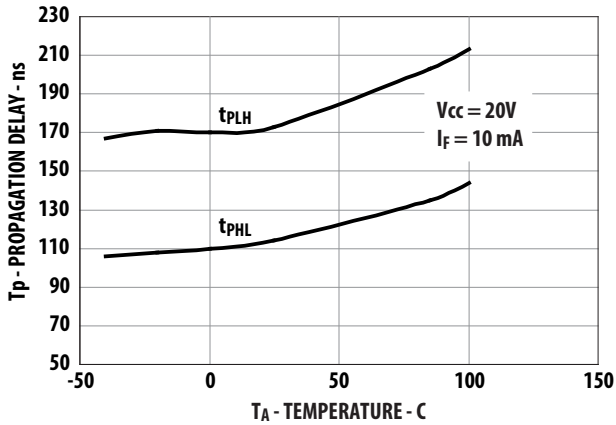

Figure 7: Typical Logic High Output Voltage vs. Supply Voltage

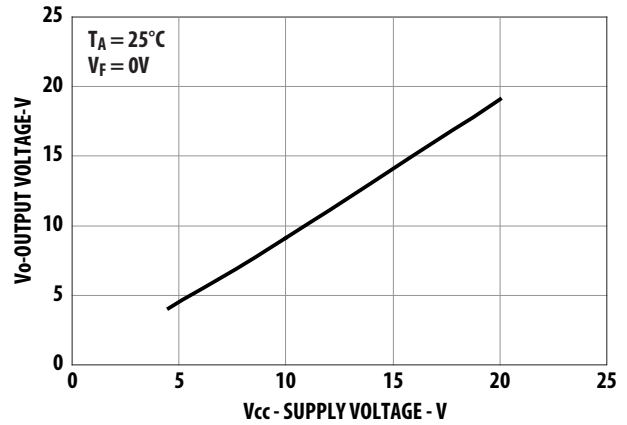

Figure 8: Typical Propagation Delay vs. Supply Voltage

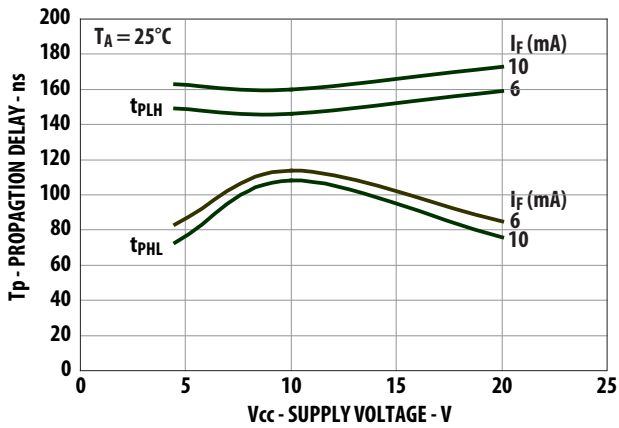

Figure 9: V_{OH} vs. I_{OH} Across Temperatures

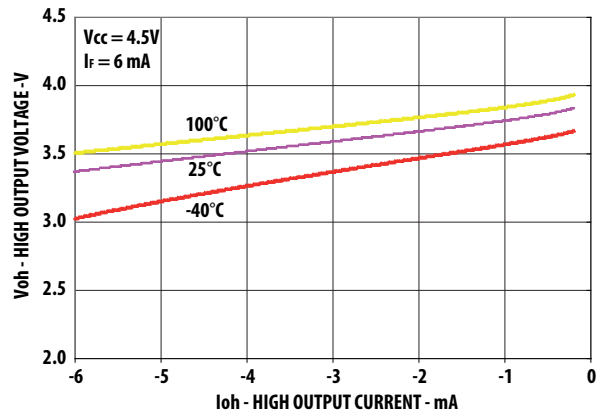

Figure 10: V_{OL} vs. I_{OL} Across Temperatures

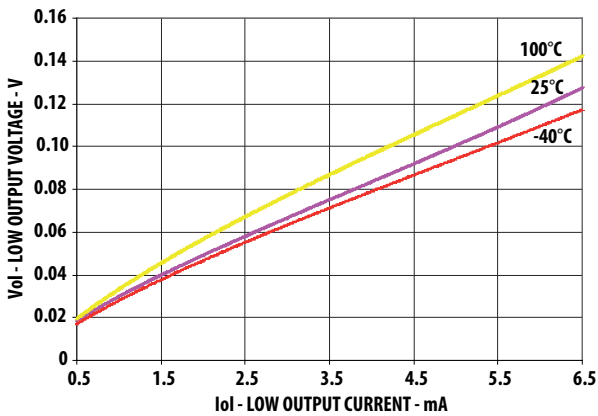

Figure 11: Test Circuit for Common Mode Transient Immunity and Typical Waveforms

