

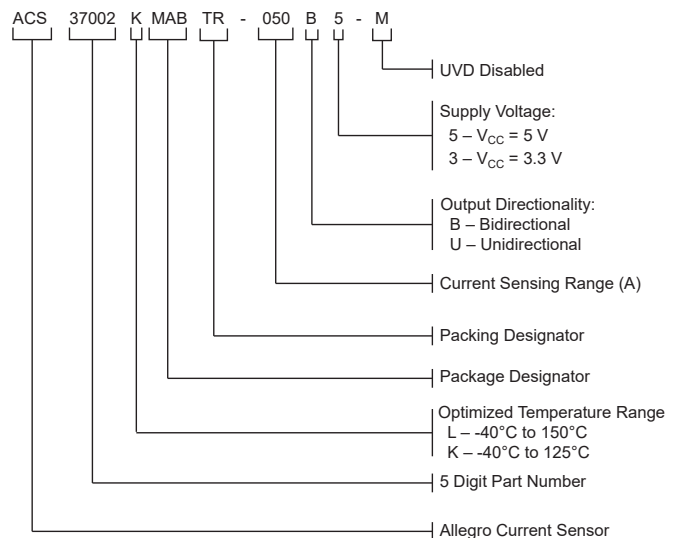

### FEATURES AND BENEFITS (continued)

- Enabling measurement ranges from 10 to 133 A in both unidirectional and bidirectional modes
- Low internal primary conductor resistance 0.85 mΩ (MA) and 1 mΩ (LA) for better power efficiency
- UL 62368-1:2014 (ed. 2) certification, highly isolated compact SOICW-16 surface mount package (MA)
  - 3125 V<sub>RMS</sub> rated dielectric withstand voltage
  - 1097 V<sub>RMS</sub> / 1550 V<sub>DC</sub> basic insulation voltages
  - 565 V<sub>RMS</sub> / 800 V<sub>DC</sub> reinforced insulation voltages
- Wide operating temperature, -40°C to 150°C
- AEC-Q100 Grade 0, automotive qualified

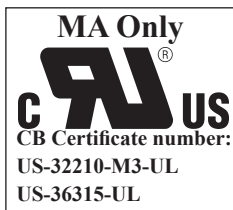

### SELECTION GUIDE

Part Number	Current Sensing Range, I <sub>PR</sub> (A)	Sensitivity [1] (mV/A)	Nominal V <sub>CC</sub> (V)	Optimized Temp. Range T <sub>A</sub> (°C)	Packing [2]
<b>MA Package, 16-Pin SOICW</b>					
ACS37002LMABTR-050B5-M	±33, ±40, ±50, ±66	60, 50, 40, 30	5	-40 to 150	1000 pieces per 13-inch reel
ACS37002LMABTR-066B5-M	±66, ±80, ±100, ±133	30, 25, 20, 15			
ACS37002LMABTR-050U5-M	33, 40, 50, 66	120, 100, 80, 60			
ACS37002LMABTR-066U5-M	66, 80, 100, 133	60, 50, 40, 30			
ACS37002LMABTR-050B3	±33, ±40, ±50, ±66	39.6, 33, 26.4, 19.8	3.3		
ACS37002LMABTR-066B3	±66, ±80, ±100, ±133	19.8, 16.5, 13.2, 9.9			
ACS37002LMABTR-050U3	33, 40, 50, 66	79.2, 66, 52.8, 39.6			
ACS37002LMABTR-066U3	66, 80, 100, 133	39.6, 33, 26.4, 19.8			
ACS37002KMABTR-050B5-M	±33, ±40, ±50, ±66	60, 50, 40, 30	5	-40 to 125 [3]	
ACS37002KMABTR-050B3	±33, ±40, ±50, ±66	39.6, 33, 26.4, 19.8	3.3		
<b>LA Package, 16-Pin SOICW</b>					
ACS37002LLAATR-015B5	±10, ±12, ±15, ±20	200, 166.6, 133.3, 100	5	-40 to 150	1000 pieces per 13-inch reel
ACS37002LLAATR-025B5	±25, ±30, ±37.5, ±50	80, 66.6, 53.3, 40			
ACS37002LLAATR-015B3	±10, ±12, ±15, ±20	132, 110, 88, 66	3.3		
ACS37002LLAATR-025U3	25, 30, 37.5, 50	105.6, 88, 70.4, 52.8			

[1] Refer to the part specific performance characteristics sections for Gain\_Sel configuration.

[2] Contact Allegro for additional options.

[3] The device performance is optimized from -40°C to 125°C; however, the device can still operate to an ambient temperature of 150°C. The device shares the same qualifications as the L temperature devices unless otherwise stated.

### Table of Contents

Features and Benefits.....	1	Power Supply Offset Error ( $V_{PS}$ ) .....	30
Description .....	1	Offset Power Supply Rejection Ratio (PSRRO).....	30
Packages .....	1	Power Supply Sensitivity Error (EPS) .....	30
Selection Guide .....	2	Sensitivity Power Supply Rejection Ratio (PSRRS) .....	30
Absolute Maximum Ratings .....	4	Fault Behavior .....	31
Isolation and Package Characteristics .....	5	Overcurrent Fault (OCF) .....	31
MA Package Specific Performance.....	5	Overcurrent Fault Operating Range/Point ( $I_{OCF-OR}$ , $I_{OCF-OP}$ )..	31
LA Package Specific Performance.....	5	Overcurrent Fault Hysteresis ( $I_{OCF-Hyst}$ ).....	31
Pinout Diagram and Terminal List.....	6	Voltage Overcurrent Pin (VOC) .....	31
Functional Block Diagram .....	7	Overcurrent Fault Error ( $E_{OCF}$ ).....	32
Common Electrical Characteristics .....	8	Overcurrent Fault Response Time ( $t_{OCF}$ ).....	32
Performance Characteristics.....	11	Overcurrent Fault Reaction Time ( $t_{OCF-R}$ ) .....	32
Functional Description .....	25	Overcurrent Fault Mask Time ( $t_{OCF-MASK}$ ) .....	32
Power-On Reset Operation .....	25	Overcurrent Fault Hold Time ( $t_{OCF-HOLD}$ ).....	32
Power-On/Power-Off.....	25	Overcurrent Fault Persist.....	32
Overvoltage Detection (OVD).....	26	OCF Disable .....	32
Absolute Maximum Ratings .....	27	Response Characteristics Definitions and Performance Data... 33	
Supply Zener Clamp Voltages .....	27	Response Time ( $t_{RESPONSE}$ ) .....	33
Forward and Reverse Supply Voltage .....	27	Propagation Time ( $t_{pd}$ ) .....	33
Forward and Reverse Output Voltage .....	27	Rise Time ( $t_R$ ).....	33
Forward and Reverse Reference/Fault Voltage .....	27	Output Slew Rate (SR) .....	33
Output Source and Sink Current.....	27	Temperature Compensation .....	34
Definitions of Operating and Performance Characteristics .....	28	Temperature Compensation Update Rate .....	34
Zero Current Voltage Output ( $V_{IOUT(Q)}$ , QVO) .....	28	Application and Theory .....	35
QVO Temperature Drift ( $V_{QE}$ ) .....	28	Application Circuits.....	35
Reference Voltage ( $V_{REF}$ ) .....	28	Theory and Functionality – VOC and OCF .....	36
Reference Voltage Temperature Drift (VRE) .....	28	VOC Driven by Non-Inverting Buffered VREF .....	36
Offset Voltage (VOE).....	28	Power Supply Decoupling Capacitor and	
Output Saturation Voltage ( $V_{SAT(HIGH/LOW)}$ ).....	28	Output Capacitive Loads .....	36
Output Voltage Operating Range ( $V_{OOR}$ ).....	28	Dynamically Change Gain in a System .....	37
Sensitivity (Sens).....	29	Thermal Performance .....	38
Sensitivity Error ( $E_{sens}$ ) .....	29	Thermal Rise vs. Primary Current .....	38
Gain Selection Pins.....	29	Evaluation Board Layout .....	38
Full Scale (FS).....	29	Package Outline Drawings .....	39
Nonlinearity ( $E_{LIN}$ ).....	29	MA Package.....	39
Total Output Error ( $E_{TOT}$ ).....	30	LA Package.....	40

### ABSOLUTE MAXIMUM RATINGS

Characteristic	Symbol	Notes	Rating	Unit	
Forward Supply Voltage	$V_{FCC}$		6.5	V	
Reverse Supply Voltage	$V_{RCC}$		-0.5	V	
Forward Output Voltage	$V_{FIOUT}$	Applies to $V_{IOUT}$ , $V_{OCF}$ , and $V_{REF}$	$(V_{CC} + 0.7) \leq 6.5$	V	
Reverse Output Voltage	$V_{RIOUT}$	Applies to $V_{IOUT}$ , $V_{OCF}$ , and $V_{REF}$	-0.5	V	
Forward Input Voltage	$V_{FI}$	Applies to GAIN_SEL0, GAIN_SEL1, and VOC	$(V_{CC} + 0.7) \leq 6.5$	V	
Reverse Input Voltage	$V_{RI}$	Applies to GAIN_SEL0, GAIN_SEL1, and VOC	-0.5	V	
Maximum Continuous Current [1]	$I_{CMAX}$	$T_A = 25^\circ\text{C}$	MA package	60	A
			LA package	55	A
Operating Ambient Temperature	$T_A$		-40 to 150	$^\circ\text{C}$	
Storage Temperature	$T_{stg}$		-65 to 165	$^\circ\text{C}$	
Maximum Junction Temperature	$T_{J(max)}$		165	$^\circ\text{C}$	

[1] Tested on the ASEK37002 Evaluation Board (TED-0002825).

### ISOLATION AND PACKAGE CHARACTERISTICS

Characteristic	Symbol	Notes	Rating	Unit
Dielectric Surge Voltage	$V_{SURGE}$	Tested in oil, $\pm 5$ pulses at 2/minute in compliance to IEC 61000-4-5 1.2 $\mu s$ (rise) / 50 $\mu s$ (width)	10	kV
Surge Current [1]	$I_{SURGE}$	Tested in compliance to IEC 61000-4-5 8 $\mu s$ (rise) / 20 $\mu s$ (width)	13	kA
Comparative Track Index	CTI	Material Group II	400 to 599	V
Moisture Sensitivity Level	MSL	Per IPC/JEDEC J-STD-020	3	–

[1] Certification pending.

### MA PACKAGE SPECIFIC PERFORMANCE

Characteristic	Symbol	Notes	Rating	Unit
Distance Through Insulation	DTI	Minimum internal distance through insulation	90	$\mu m$
Dielectric Withstand Voltage	$V_{ISO}$	Agency rated for 60 seconds per UL 62368-1:2014 (edition 2) [1][2]	3125	$V_{RMS}$
Impulse Withstand Voltage	$V_{IMPULSE}$	Tested in air, $\pm 5$ pulses at 2/minute in compliance to IEC 61000-4-5 1.2 $\mu s$ (rise) / 50 $\mu s$ (width)	6000	$V_{PK}$
Working Voltage for Basic Insulation	$V_{WVBI}$	Maximum approved working voltage for basic insulation according to UL 62368-1:2014 (edition 2)	1550	$V_{PK}$ or $V_{DC}$
			1097	$V_{RMS}$
Working Voltage for Reinforced Insulation	$V_{WVRI}$	Maximum approved working voltage for reinforced insulation according to UL 62368-1:2014 (edition 2)	800	$V_{PK}$ or $V_{DC}$
			565	$V_{RMS}$
Clearance	$D_{cl}$	Minimum distance through air from IP leads to signal leads	7.9	mm
Creepage	$D_{cr}$	Minimum distance along package body from IP leads to signal leads	7.9	mm

[1] Production tested for 1 second at 3125  $V_{RMS}$  per UL 62368-1 (edition 2).

[2] Agency type-tested at 5000 V for 1 minute per UL 62368-1 (edition 2) Section 5.4.7.

### LA PACKAGE SPECIFIC PERFORMANCE

Characteristic	Symbol	Notes	Rating	Unit
Distance Through Insulation	DTI	Minimum internal distance through insulation	45	$\mu m$
Dielectric Withstand Voltage	$V_{ISO}$	Agency rated for 60 seconds per UL 62368-1:2014 (edition 2) [1][2]	2250	$V_{RMS}$
Impulse Withstand Voltage	$V_{IMPULSE}$	Tested in air, $\pm 5$ pulses at 2/minute in compliance to IEC 61000-4-5 1.2 $\mu s$ (rise) / 50 $\mu s$ (width)	4000	$V_{PK}$
Working Voltage for Basic Insulation [3]	$V_{WVBI}$	Maximum approved working voltage for basic insulation according to UL 62368-1:2014 (edition 2)	870	$V_{PK}$ or $V_{DC}$
			616	$V_{RMS}$
Clearance [3]	$D_{cl}$	Minimum distance through air from IP leads to signal leads	7.5	mm
Creepage [3]	$D_{cr}$	Minimum distance along package body from IP leads to signal leads	7.5	mm

[1] Production tested for 1 second at 2250  $V_{RMS}$  per UL 62368-1 (edition 2).

[2] Agency type-tested at 3600 V for 1 minute per UL 62368-1 (edition 2) Section 5.4.7.

[3] Certification pending.

### PINOUT DIAGRAM AND TERMINAL LIST TABLE

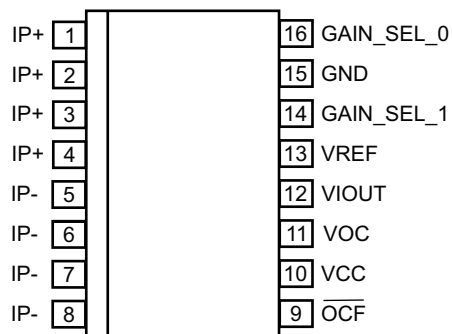
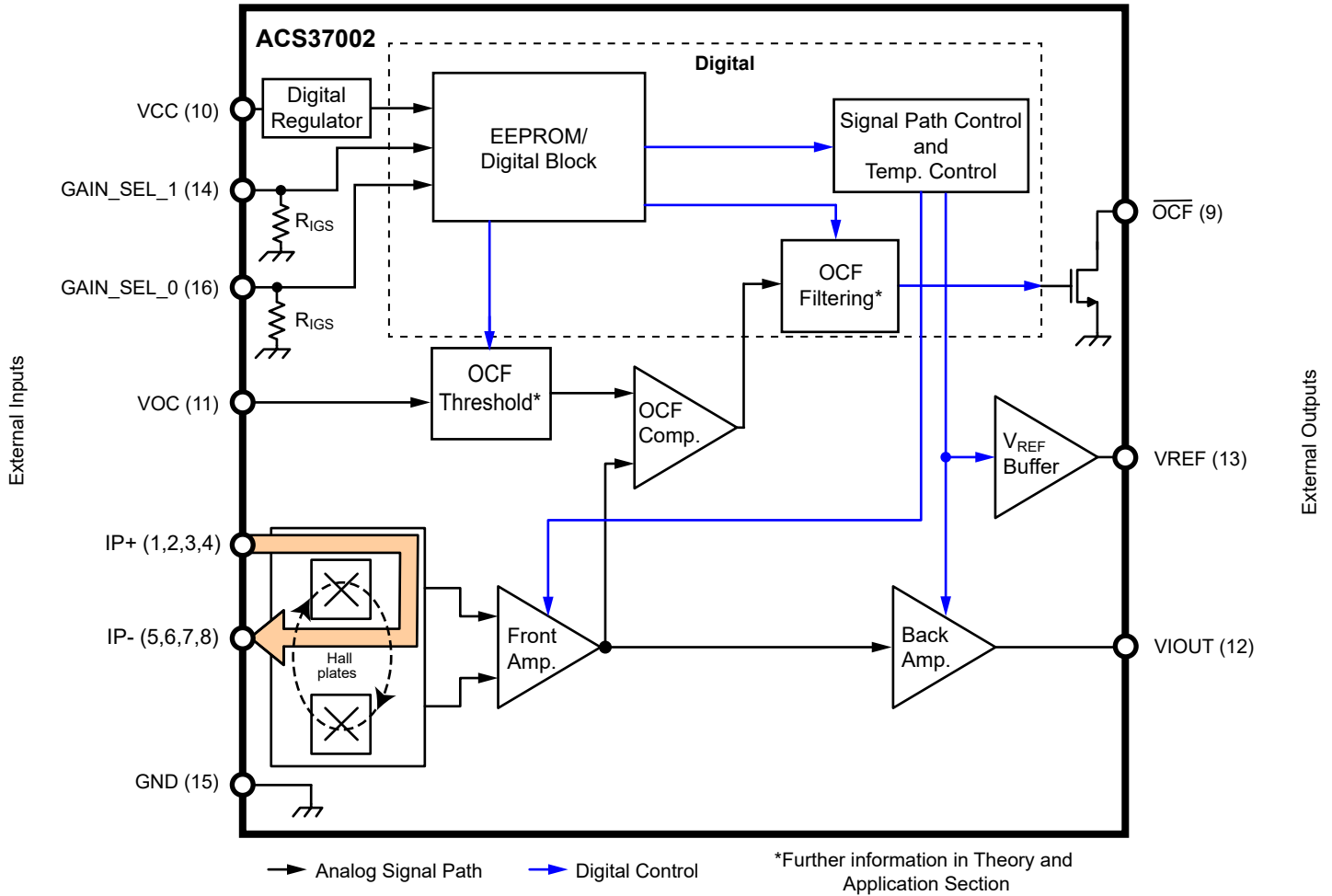

Figure 2: MA/LA Pinout Diagram

#### Terminal List Table

Number	Name	Description
1, 2, 3, 4	IP+	Terminals for current being sensed; fused internally
5, 6, 7, 8	IP-	Terminals for current being sensed; fused internally
9	OCF	Overcurrent fault, open-drain
10	VCC	Device power supply terminal
11	VOC	Overcurrent fault operation point input
12	VIOUT	Analog output representing the current flowing through I <sub>p</sub>
13	VREF	Zero current voltage reference
14	GAIN_SEL_1	Gain selection bit 1
15	GND	Device ground terminal
16	GAIN_SEL_0	Gain selection bit 0



**Figure 3: Functional Block Diagram**

**COMMON ELECTRICAL CHARACTERISTICS:** Valid through full operating temperature range,  $T_A = -40^\circ\text{C}$  to  $150^\circ\text{C}$ ,  $C_{\text{BYPASS}} = 0.1 \mu\text{F}$ , and  $V_{\text{CC}} = 5 \text{ V}$  or  $3.3 \text{ V}$ , unless otherwise specified

Characteristic	Symbol	Test Conditions	Min.	Typ.	Max.	Units
Supply Voltage	$V_{\text{CC}}$	5 V devices only	4.5	5	5.5	V
		3.3 V devices only	3.15	3.3	3.6	V
Supply Current	$I_{\text{CC}}$	No load on VIOOUT or VREF; $V_{\text{CC}} = 5 \text{ V}$	–	13	18	mA
		No load on VIOOUT or VREF; $V_{\text{CC}} = 3.3 \text{ V}$	–	12	15	mA
Supply Bypass Capacitor	$C_{\text{BYPASS}}$	VCC to GND recommended	0.1	–	–	$\mu\text{F}$
Output Resistive Load	$R_{\text{L}}$	VIOOUT to GND, VIOOUT to VCC	10	–	–	k $\Omega$
Output Capacitive Load	$C_{\text{L}}$	VIOOUT to GND	–	1	6	nF
Reference Resistive Load	$R_{\text{VREF}}$	VREF to GND (recommended to supply VOC); VREF to VCC	10	–	–	k $\Omega$
Reference Capacitive Load	$C_{\text{VREF}}$	VREF to GND	–	–	6	nF
Fault Pull-Up Resistance	$R_{\text{PU}}$		4.7	–	500	k $\Omega$
Primary Conductor Resistance	$R_{\text{IP}}$	MA, $T_A = 25^\circ\text{C}$	–	0.85	–	m $\Omega$
		LA, $T_A = 25^\circ\text{C}$	–	1	–	m $\Omega$
Primary Conductor Inductance	$L_{\text{IP}}$	MA package	–	4.2	–	nH
		LA package	–	5	–	nH
Output Buffer Resistance	$R_{\text{OUT}}$	Internal output buffer resistance on VIOOUT and VREF	–	4	–	$\Omega$
Power-On Reset Voltage	$V_{\text{POR(H)}}$	$V_{\text{CC}}$ rising [1]	2.6	2.9	3.1	V
	$V_{\text{POR(L)}}$	$V_{\text{CC}}$ falling [1]	2.2	2.5	2.8	V
POR Hysteresis	$V_{\text{POR(HYS)}}$		250	–	–	mV
Power-On Time	$t_{\text{POD}}$	Time from $V_{\text{CC}}$ rising $\geq V_{\text{POR(H)}}$ after a POR event until power-on; VREF, OCF, VIOOUT	100	–	–	$\mu\text{s}$
Overvoltage Detection (OVD) Threshold	$V_{\text{OVD(H)}}$	$T_A = 25^\circ\text{C}$ , $V_{\text{CC}}$ rising [1]	6.1	6.3	6.8	V
	$V_{\text{OVD(L)}}$	$T_A = 25^\circ\text{C}$ , $V_{\text{CC}}$ falling [1]	5.6	5.8	6.1	V
Overvoltage Detection Hysteresis	$V_{\text{OVD(HYS)}}$		–	660	–	mV
OVD Delay Time	$t_{\text{dOVD(E)}}$	Time from $V_{\text{CC}}$ rising $\geq V_{\text{OVD(EN)}}$ until OVD asserts	35	90	120	$\mu\text{s}$
	$t_{\text{dOVD(D)}}$	Time from $V_{\text{CC}}$ falling $\leq V_{\text{OVD(DIS)}}$ until OVD clears	–	7	–	$\mu\text{s}$

Continued on the next page...



**COMMON PERFORMANCE CHARACTERISTICS (V<sub>IOUT</sub>):** Valid through full operating temperature range, T<sub>A</sub> = -40°C to 150°C, C<sub>BYPASS</sub> = 0.1 μF, and V<sub>CC</sub> = 5 V or 3.3 V, unless otherwise specified

Characteristic	Symbol	Test Conditions	Min.	Typ.	Max.	Units	
<b>OUTPUT SIGNAL CHARACTERISTICS (V<sub>IOUT</sub>)</b>							
Saturation Voltage	V <sub>SAT(H)</sub>	R <sub>L</sub> = 10 kΩ to GND	V <sub>CC</sub> - 0.25	-	-	V	
	V <sub>SAT(L)</sub>	R <sub>L</sub> = 10 kΩ to V <sub>CC</sub>	-	-	0.15	V	
Output Operating Range	V <sub>OOR</sub>	5 V linear operating range	0.5	-	4.5	V	
		3.3 V linear operating range	0.3	-	3.0	V	
Output Current Limit	I <sub>OUT(src)</sub>	V <sub>IOUT</sub> shorted to GND	-	25	-	mA	
	I <sub>OUT(snk)</sub>	V <sub>IOUT</sub> shorted to V <sub>CC</sub>	-	25	-	mA	
Output Drive	I <sub>OUT</sub>		4.8	-	-	mA	
Bandwidth	BW	Small signal -3 dB, C <sub>L</sub> = 6 nF	-	400	-	kHz	
Rise Time	t <sub>R</sub>	T <sub>A</sub> = 25°C, C <sub>L</sub> = 6 nF	-	0.7	2.5	μs	
Response Time	t <sub>RESPONSE</sub>	T <sub>A</sub> = 25°C, C <sub>L</sub> = 6 nF	-	1.1	2.5	μs	
Propagation Delay	t <sub>pd</sub>	T <sub>A</sub> = 25°C, C <sub>L</sub> = 6 nF	-	0.7	2	μs	
Noise Density	I <sub>ND</sub>	Input-referenced noise density; T <sub>A</sub> = 25°C, C <sub>L</sub> = 6 nF; V <sub>CC</sub> = 5 V	MA Package	-	350	-	μA/√Hz
			LA Package	-	155	-	μA/√Hz
		Input-referenced noise density; T <sub>A</sub> = 25°C, C <sub>L</sub> = 6 nF; V <sub>CC</sub> = 3.3 V	MA Package	-	450	-	μA/√Hz
			LA Package	-	200	-	μA/√Hz
Noise	I <sub>N</sub>	Input-referenced noise at 400 kHz; T <sub>A</sub> = 25°C, C <sub>L</sub> = 6 nF; V <sub>CC</sub> = 5 V	MA Package	-	277	-	mA <sub>RMS</sub>
			LA Package	-	124	-	mA <sub>RMS</sub>
		Input-referenced noise at 400 kHz; T <sub>A</sub> = 25°C, C <sub>L</sub> = 6 nF; V <sub>CC</sub> = 3.3 V	MA Package	-	357	-	mA <sub>RMS</sub>
			LA Package	-	160	-	mA <sub>RMS</sub>
Nonlinearity	E <sub>LIN</sub>		-	±0.75	-	%	
Power Supply Rejection Ratio Offset	PSRR <sub>O</sub>	T <sub>A</sub> = 25°C, DC to 1 kHz, 100 mV pk-pk ripple around V <sub>CC</sub> = V <sub>CC(typ)</sub> ; I <sub>P</sub> = 0 A	-	-40	-	dB	
		T <sub>A</sub> = 25°C, 1 to 100 kHz, 100 mV pk-pk ripple around V <sub>CC</sub> = V <sub>CC(typ)</sub> ; I <sub>P</sub> = 0 A	-	-30	-	dB	
Power Supply Rejection Ratio Sens	PSRR <sub>S</sub>	T <sub>A</sub> = 25°C, DC to 1 kHz, 100 mV pk-pk ripple around V <sub>CC</sub> = V <sub>CC(typ)</sub> ; I <sub>P</sub> = I <sub>PR(MAX)</sub>	-	-15	-	dB	
		T <sub>A</sub> = 25°C, 1 to 100 kHz, 100 mV pk-pk ripple around V <sub>CC</sub> = V <sub>CC(typ)</sub> ; I <sub>P</sub> = I <sub>PR(MAX)</sub>	-	-6	-	dB	
Power Supply Offset Error	V <sub>OE(PS)</sub>	Bidirectional; V <sub>CC</sub> @ V <sub>CC(MIN)</sub> or V <sub>CC(MAX)</sub>	-10	-	10	mV	
		Unidirectional; V <sub>CC</sub> @ V <sub>CC(MIN)</sub> or V <sub>CC(MAX)</sub>	MA Package	-18	-	18	mV
			LA Package	-10	-	10	mV
Power Supply Sensitivity Error	E <sub>SENS(PS)</sub>	V <sub>CC</sub> @ V <sub>CC(MIN)</sub> or V <sub>CC(MAX)</sub>	-1.5	-	1.5	%	
Common-Mode Field Rejection	CMFR	Input-referred error due to common-mode field	-	4	-	mA/G	

Continued on the next page...

**COMMON PERFORMANCE CHARACTERISTICS (VREF, FAULT, GAIN\_SEL):** Valid through full operating temperature range,  $T_A = -40^{\circ}\text{C}$  to  $150^{\circ}\text{C}$ ,  $C_{\text{BYPASS}} = 0.1 \mu\text{F}$ , and  $V_{\text{CC}} = 5 \text{ V}$  or  $3.3 \text{ V}$ , unless otherwise specified

Characteristic	Symbol	Test Conditions	Min.	Typ.	Max.	Units
<b>REFERENCE OUTPUT CHARACTERISTICS (VREF)</b>						
Zero Current Reference Voltage	$V_{\text{REF(BI)}}$	Bidirectional; $V_{\text{CC}} = 5 \text{ V}$	2.49	2.5	2.51	V
		Bidirectional; $V_{\text{CC}} = 3.3 \text{ V}$	1.64	1.65	1.66	V
	$V_{\text{REF(UNI)}}$	Unidirectional; $V_{\text{CC}} = 5 \text{ V}$	0.49	0.5	0.51	V
		Unidirectional; $V_{\text{CC}} = 3.3 \text{ V}$	0.32	0.33	0.34	V
Reference Source Current Limit	$I_{\text{REF(SRC)}}$	Maximum current $V_{\text{REF}}$ can passively source	–	25	–	mA
	$I_{\text{REF(SNK)}}$	Maximum current $V_{\text{REF}}$ can passively sink	–	–25	–	mA
Reference Slew Rate	$SR_{\text{REF}}$	$C_{\text{VREF}} = 0 \text{ nF}$ , $R_{\text{VREF}} = 0 \Omega$	0.8	–	–	V/ $\mu\text{s}$
<b>OVERCURRENT FAULT CHARACTERISTICS (OCF)</b>						
OCF On Voltage <sup>[3]</sup>	$V_{\text{FAULT-ON}}$	$R_{\text{PU}} = 4.7 \text{ k}\Omega$ , under fault condition	–	0.07	0.4	V
OCF Sink Current <sup>[3]</sup>	$I_{\text{OCF(SNK)}}$	No Fault	–	100	–	nA
		Fault Assertion	0.01	–	1.1	mA
VOC Operating Voltage Range	$V_{\text{VOC}}$	$V_{\text{CC}} = 5 \text{ V}$	0.5	–	2	V
		$V_{\text{CC}} = 3.3 \text{ V}$	0.33	–	1.32	V
Fault Error	$E_{\text{OCF}}$		–10	$\pm 3$	10	% $I_{\text{OCF-OP}}$
OCF Hysteresis	$I_{\text{OCF(HYS)}}$	$V_{\text{CC}} = 5 \text{ V}$	–	6	–	%FS
		$V_{\text{CC}} = 3.3 \text{ V}$	–	9	–	%FS
OCF Reaction Time <sup>[3]</sup>	$t_{\text{OCF-R}}$	Time from $I_{\text{OCF-OP}}$ with a $1.2 \times I_{\text{OCF-OP}}$ until fault asserts	–	1	1.5	$\mu\text{s}$
OCF Mask <sup>[3]</sup>	$t_{\text{OCF-MASK}}$	Time $I_{\text{OCF-OP}}$ must be present after $t_{\text{OCF-R}}$ for fault assertion <sup>[3]</sup>	0	0	3	$\mu\text{s}$
OCF Response Time <sup>[3]</sup>	$t_{\text{OCF}}$	$t_{\text{OCF-MASK}} = 0 \mu\text{s}$	–	1	1.5	$\mu\text{s}$
OCF Hold Time <sup>[3]</sup>	$t_{\text{OCF-HOLD}}$	Minimum duration of FAULT assertion <sup>[2]</sup>	0	0	5	ms
<b>GAIN SELECTION PIN CHARACTERISTICS (GAIN_SEL0, GAIN_SEL1)</b>						
Gain Select Internal Resistor	$R_{\text{GSint}}$		–	1	–	M $\Omega$
GAIN_SEL Logic Input Voltage	$V_{\text{H(SEL)}}$	$V_{\text{CC}} = 5 \text{ V}$	3.75	–	–	V
		$V_{\text{CC}} = 3.3 \text{ V}$	2.25	–	–	V
	$V_{\text{L(SEL)}}$		–	–	0.5	V
Leakage Current <sup>[3]</sup>	$I_{\text{SEL(SNK)}}$		–	–	$\pm 10$	$\mu\text{A}$

<sup>[1]</sup>  $V_{\text{CC}}$  rate +1 V/ms, for best accuracy.

<sup>[2]</sup> Typical value is factory default.

<sup>[3]</sup> Guaranteed by design and bench validated

### ACS37002LMABTR-050B5-M

ACS37002LMABTR-050B5-M Gain\_Sel Pin Performance Key

				Selection Identifier
Parameter (Units)	Gain_Sel_1 (Boolean)	Gain_Sel_0 (Boolean)	Sens (mV/A)	Max IP (A)
Type	Digital Input	Digital Input	Calculation	Bidirectional
Selection Combination	0	0	40	50
	0	1	50	40
	1	0	60	33.3
	1	1	30	66.7

**ACS37002LMABTR-050B5-M PERFORMANCE CHARACTERISTICS:** Valid through full operating temperature range,  $T_A = -40^\circ\text{C}$  to  $150^\circ\text{C}$ ,  $C_{\text{BYPASS}} = 0.1 \mu\text{F}$ , and  $V_{\text{CC}} = 5 \text{ V}$ , unless otherwise specified

Characteristic	Symbol	Test Conditions	Min.	Typ. [1]	Max.	Units
<b>NOMINAL PERFORMANCE</b>						
Current Sensing Range	$I_{\text{PR}}$	Gain Sel 00	-50	-	50	A
		Gain Sel 01	-40	-	40	A
		Gain Sel 10	-33.3	-	33.3	A
		Gain Sel 11	-66.7	-	66.7	A
Sensitivity	Sens	Gain Sel 00; $I_{\text{PR}(\text{min})} < I_{\text{P}} < I_{\text{PR}(\text{max})}$	-	40	-	mV/A
		Gain Sel 01; $I_{\text{PR}(\text{min})} < I_{\text{P}} < I_{\text{PR}(\text{max})}$	-	50	-	mV/A
		Gain Sel 10; $I_{\text{PR}(\text{min})} < I_{\text{P}} < I_{\text{PR}(\text{max})}$	-	60	-	mV/A
		Gain Sel 11; $I_{\text{PR}(\text{min})} < I_{\text{P}} < I_{\text{PR}(\text{max})}$	-	30	-	mV/A
Overcurrent Fault Operating Range	$I_{\text{OCF-OR}}$	Typ. = factory-programmed default, FS = Full-Scale	50	100	200	%FS
Zero Current Output Voltage	$V_{\text{IOUT(Q)}}$	Bidirectional; $I_{\text{P}} = 0 \text{ A}$ , $T_A = 25^\circ\text{C}$	-	2.5	-	V
<b>TOTAL ERROR (<math>V_{\text{IOUT(ACTUAL)}} - (\text{Sens}_{\text{IDEAL}} \times I_{\text{PR}} + V_{\text{REF}})</math>) / (<math>\text{Sens}_{\text{IDEAL}} \times I_{\text{PR}}</math>) × 100 AND TOTAL ERROR COMPONENTS</b>						
Total Error	$E_{\text{TOT}}$	$I_{\text{P}} = I_{\text{PR}(\text{max})}$	-1.75	-0.5 ±0.6	1.75	%
Sensitivity Error	$E_{\text{SENS}}$	$I_{\text{P}} = I_{\text{PR}(\text{max})}$ , $T_A = 25^\circ\text{C}$ to $150^\circ\text{C}$ or $-40^\circ\text{C}$ to $25^\circ\text{C}$	-1.5	-0.5 ±0.6	1.5	%
Zero Current Reference Error	$V_{\text{RE}}$	$V_{\text{REFactual}} - V_{\text{REFideal}}$ , $I_{\text{P}} = 0 \text{ A}$ , $T_A = 25^\circ\text{C}$ to $150^\circ\text{C}$	-10	-2 ±3	10	mV
		$V_{\text{REFactual}} - V_{\text{REFideal}}$ , $I_{\text{P}} = 0 \text{ A}$ , $T_A = -40^\circ\text{C}$ to $25^\circ\text{C}$	-10	-1 ±3	10	mV
Offset Error	$V_{\text{OE}}$	$V_{\text{IOUT(Q)}} - V_{\text{REF}}$ , $I_{\text{P}} = 0 \text{ A}$ , $T_A = 25^\circ\text{C}$ to $150^\circ\text{C}$	-8	-1 ±4	8	mV
		$V_{\text{IOUT(Q)}} - V_{\text{REF}}$ , $I_{\text{P}} = 0 \text{ A}$ , $T_A = -40^\circ\text{C}$ to $25^\circ\text{C}$	-8	-1 ±3	8	mV
QVO Error	$V_{\text{QE}}$	$V_{\text{IOUT(Q)}}$ , $I_{\text{P}} = 0 \text{ A}$ , $T_A = 25^\circ\text{C}$ to $150^\circ\text{C}$	-10	-3 ±5	10	mV
		$V_{\text{IOUT(Q)}}$ , $I_{\text{P}} = 0 \text{ A}$ , $T_A = -40^\circ\text{C}$ to $25^\circ\text{C}$	-10	-1 ±4	10	mV
<b>TOTAL ERROR AND TOTAL ERROR COMPONENTS INCLUDING LIFETIME DRIFT [2,3]</b>						
Total Error Including Lifetime Drift	$E_{\text{TOT\_LTD}}$	$I_{\text{P}} = I_{\text{PR}(\text{max})}$	-3.6	-1.6 ±1.2	3.6	%
Sensitivity Error Including Lifetime Drift	$E_{\text{SENS\_LTD}}$	$I_{\text{P}} = I_{\text{PR}(\text{max})}$ , $T_A = 25^\circ\text{C}$ to $150^\circ\text{C}$ or $-40^\circ\text{C}$ to $25^\circ\text{C}$	-3.4	-1.5 ±1.1	3.4	%
Zero Current Reference Error Including Lifetime Drift	$V_{\text{RE\_LTD}}$	$V_{\text{REFactual}} - V_{\text{REFideal}}$ , $I_{\text{P}} = 0 \text{ A}$ , $T_A = 25^\circ\text{C}$ to $150^\circ\text{C}$	-10	-3 ±4	10	mV
		$V_{\text{REFactual}} - V_{\text{REFideal}}$ , $I_{\text{P}} = 0 \text{ A}$ , $T_A = -40^\circ\text{C}$ to $25^\circ\text{C}$	-10	-2 ±3	10	mV
Offset Error Including Lifetime Drift	$V_{\text{OE\_LTD}}$	$V_{\text{IOUT(Q)}} - V_{\text{REF}}$ , $I_{\text{P}} = 0 \text{ A}$ , $T_A = 25^\circ\text{C}$ to $150^\circ\text{C}$	-10	-2 ±5	10	mV
		$V_{\text{IOUT(Q)}} - V_{\text{REF}}$ , $I_{\text{P}} = 0 \text{ A}$ , $T_A = -40^\circ\text{C}$ to $25^\circ\text{C}$	-10	±4	10	mV
QVO Error Including Lifetime Drift	$V_{\text{QE\_LTD}}$	$V_{\text{IOUT(Q)}}$ , $I_{\text{P}} = 0 \text{ A}$ , $T_A = 25^\circ\text{C}$ to $150^\circ\text{C}$	-14	-4 ±6	14	mV
		$V_{\text{IOUT(Q)}}$ , $I_{\text{P}} = 0 \text{ A}$ , $T_A = -40^\circ\text{C}$ to $25^\circ\text{C}$	-10	±7	10	mV

[1] Typical values are the mean ±3 sigma of production distributions. These are formatted as mean ±3 sigma.

[2] Typical values are the mean ±3 sigma statistical combination of production and AEC-Q100 individual drift distributions. These are formatted as mean ±3 sigma.

[3] Lifetime drift characteristics are based on a statistical combination of production distributions and worst case distribution of parametric drift of individuals observed during AEC-Q100 qualification.

### ACS37002LMABTR-066B5-M

ACS37002LMABTR-066B5-M Gain\_Sel Pin Performance Key

				Selection Identifier
Parameter (Units)	Gain_Sel_1 (Boolean)	Gain_Sel_0 (Boolean)	Sens (mV/A)	Max IP (A)
Type	Digital Input	Digital Input	Calculation	Bidirectional
Selection Combination	0	0	30	66.7
	0	1	25	80
	1	0	20	100
	1	1	15	133.3

**ACS37002LMABTR-066B5-M PERFORMANCE CHARACTERISTICS:** Valid through full operating temperature range,  $T_A = -40^\circ\text{C}$  to  $150^\circ\text{C}$ ,  $C_{\text{BYPASS}} = 0.1 \mu\text{F}$ , and  $V_{\text{CC}} = 5 \text{ V}$ , unless otherwise specified

Characteristic	Symbol	Test Conditions	Min.	Typ. [1]	Max.	Units
<b>NOMINAL PERFORMANCE</b>						
Current Sensing Range	$I_{\text{PR}}$	Gain Sel 00	-66.7	-	66.7	A
		Gain Sel 01	-80	-	80	A
		Gain Sel 10	-100	-	100	A
		Gain Sel 11	-133.3	-	133.3	A
Sensitivity	Sens	Gain Sel 00; $I_{\text{PR}(\text{min})} < I_{\text{P}} < I_{\text{PR}(\text{max})}$	-	30	-	mV/A
		Gain Sel 01; $I_{\text{PR}(\text{min})} < I_{\text{P}} < I_{\text{PR}(\text{max})}$	-	25	-	mV/A
		Gain Sel 10; $I_{\text{PR}(\text{min})} < I_{\text{P}} < I_{\text{PR}(\text{max})}$	-	20	-	mV/A
		Gain Sel 11; $I_{\text{PR}(\text{min})} < I_{\text{P}} < I_{\text{PR}(\text{max})}$	-	15	-	mV/A
Overcurrent Fault Operating Range	$I_{\text{OCF-OR}}$	Typ. = factory-programmed default, FS = Full-Scale	50	100	200	%FS
Zero Current Output Voltage	$V_{\text{IOUT(Q)}}$	Bidirectional; $I_{\text{P}} = 0 \text{ A}$ , $T_A = 25^\circ\text{C}$	-	2.5	-	V
<b>TOTAL ERROR (<math>V_{\text{IOUT(ACTUAL)}} - (\text{Sens}_{\text{IDEAL}} \times I_{\text{PR}} + V_{\text{REF}}) / (\text{Sens}_{\text{IDEAL}} \times I_{\text{PR}}) \times 100</math>) AND TOTAL ERROR COMPONENTS</b>						
Total Error	$E_{\text{TOT}}$	$I_{\text{P}} = I_{\text{PR}(\text{max})}$	-1.75	-0.5 ±0.6	1.75	%
Sensitivity Error	$E_{\text{SENS}}$	$I_{\text{P}} = I_{\text{PR}(\text{max})}$ , $T_A = 25^\circ\text{C}$ to $150^\circ\text{C}$ or $-40^\circ\text{C}$ to $25^\circ\text{C}$	-1.5	-0.5 ±0.6	1.5	%
Zero Current Reference Error	$V_{\text{RE}}$	$V_{\text{REFactual}} - V_{\text{REFideal}}$ , $I_{\text{P}} = 0 \text{ A}$ , $T_A = 25^\circ\text{C}$ to $150^\circ\text{C}$	-10	-2 ±3	10	mV
		$V_{\text{REFactual}} - V_{\text{REFideal}}$ , $I_{\text{P}} = 0 \text{ A}$ , $T_A = -40^\circ\text{C}$ to $25^\circ\text{C}$	-10	-1 ±3	10	mV
Offset Error	$V_{\text{OE}}$	$V_{\text{IOUT(Q)}} - V_{\text{REF}}$ , $I_{\text{P}} = 0 \text{ A}$ , $T_A = 25^\circ\text{C}$ to $150^\circ\text{C}$	-8	-1 ±4	8	mV
		$V_{\text{IOUT(Q)}} - V_{\text{REF}}$ , $I_{\text{P}} = 0 \text{ A}$ , $T_A = -40^\circ\text{C}$ to $25^\circ\text{C}$	-8	-1 ±3	8	mV
QVO Error	$V_{\text{QE}}$	$V_{\text{IOUT(Q)}}$ , $I_{\text{P}} = 0 \text{ A}$ , $T_A = 25^\circ\text{C}$ to $150^\circ\text{C}$	-10	-3 ±5	10	mV
		$V_{\text{IOUT(Q)}}$ , $I_{\text{P}} = 0 \text{ A}$ , $T_A = -40^\circ\text{C}$ to $25^\circ\text{C}$	-10	-1 ±4	10	mV
<b>TOTAL ERROR AND TOTAL ERROR COMPONENTS INCLUDING LIFETIME DRIFT [2,3]</b>						
Total Error Including Lifetime Drift	$E_{\text{TOT\_LTD}}$	$I_{\text{P}} = I_{\text{PR}(\text{max})}$	-3.6	-1.6 ±1.2	3.6	%
Sensitivity Error Including Lifetime Drift	$E_{\text{SENS\_LTD}}$	$I_{\text{P}} = I_{\text{PR}(\text{max})}$ , $T_A = 25^\circ\text{C}$ to $150^\circ\text{C}$ or $-40^\circ\text{C}$ to $25^\circ\text{C}$	-3.4	-1.5 ±1.1	3.4	%
Zero Current Reference Error Including Lifetime Drift	$V_{\text{RE\_LTD}}$	$V_{\text{REFactual}} - V_{\text{REFideal}}$ , $I_{\text{P}} = 0 \text{ A}$ , $T_A = 25^\circ\text{C}$ to $150^\circ\text{C}$	-10	-3 ±4	10	mV
		$V_{\text{REFactual}} - V_{\text{REFideal}}$ , $I_{\text{P}} = 0 \text{ A}$ , $T_A = -40^\circ\text{C}$ to $25^\circ\text{C}$	-10	-2 ±3	10	mV
Offset Error Including Lifetime Drift	$V_{\text{OE\_LTD}}$	$V_{\text{IOUT(Q)}} - V_{\text{REF}}$ , $I_{\text{P}} = 0 \text{ A}$ , $T_A = 25^\circ\text{C}$ to $150^\circ\text{C}$	-10	-2 ±5	10	mV
		$V_{\text{IOUT(Q)}} - V_{\text{REF}}$ , $I_{\text{P}} = 0 \text{ A}$ , $T_A = -40^\circ\text{C}$ to $25^\circ\text{C}$	-10	±4	10	mV
QVO Error Including Lifetime Drift	$V_{\text{QE\_LTD}}$	$V_{\text{IOUT(Q)}}$ , $I_{\text{P}} = 0 \text{ A}$ , $T_A = 25^\circ\text{C}$ to $150^\circ\text{C}$	-14	-4 ±6	14	mV
		$V_{\text{IOUT(Q)}}$ , $I_{\text{P}} = 0 \text{ A}$ , $T_A = -40^\circ\text{C}$ to $25^\circ\text{C}$	-10	±7	10	mV

[1] Typical values are the mean ±3 sigma of production distributions. These are formatted as mean ±3 sigma.

[2] Typical values are the mean ±3 sigma statistical combination of production and AEC-Q100 individual drift distributions. These are formatted as mean ±3 sigma.

[3] Lifetime drift characteristics are based on a statistical combination of production distributions and worst case distribution of parametric drift of individuals observed during AEC-Q100 qualification.

### ACS37002LMABTR-050U5-M

ACS37002LMABTR-050U5-M Gain\_Sel Pin Performance Key

				Selection Identifier
Parameter (Units)	Gain_Sel_1 (Boolean)	Gain_Sel_0 (Boolean)	Sens (mV/A)	Max IP (A)
Type	Digital Input	Digital Input	Calculation	Unidirectional
Selection Combination	0	0	80	50
	0	1	100	40
	1	0	120	33.3
	1	1	60	66.7

**ACS37002LMABTR-050U5-M PERFORMANCE CHARACTERISTICS:** Valid through full operating temperature range,  $T_A = -40^\circ\text{C}$  to  $150^\circ\text{C}$ ,  $C_{\text{BYPASS}} = 0.1 \mu\text{F}$ , and  $V_{\text{CC}} = 5 \text{ V}$ , unless otherwise specified

Characteristic	Symbol	Test Conditions	Min.	Typ. [1]	Max.	Units
<b>NOMINAL PERFORMANCE</b>						
Current Sensing Range	$I_{\text{PR}}$	Gain Sel 00	0	–	50	A
		Gain Sel 01	0	–	40	A
		Gain Sel 10	0	–	33.3	A
		Gain Sel 11	0	–	66.7	A
Sensitivity	Sens	Gain Sel 00; $I_{\text{PR}(\text{min})} < I_{\text{P}} < I_{\text{PR}(\text{max})}$	–	80	–	mV/A
		Gain Sel 01; $I_{\text{PR}(\text{min})} < I_{\text{P}} < I_{\text{PR}(\text{max})}$	–	100	–	mV/A
		Gain Sel 10; $I_{\text{PR}(\text{min})} < I_{\text{P}} < I_{\text{PR}(\text{max})}$	–	120	–	mV/A
		Gain Sel 11; $I_{\text{PR}(\text{min})} < I_{\text{P}} < I_{\text{PR}(\text{max})}$	–	60	–	mV/A
Overcurrent Fault Operating Range	$I_{\text{OCF-OR}}$	Typ. = factory-programmed default, FS = Full-Scale	25	50	100	%FS
Zero Current Output Voltage	$V_{\text{IOUT(Q)}}$	Unidirectional; $I_{\text{P}} = 0 \text{ A}$ , $T_A = 25^\circ\text{C}$	–	0.5	–	V
<b>TOTAL ERROR (<math>V_{\text{IOUT(ACTUAL)}} - (\text{Sens}_{\text{IDEAL}} \times I_{\text{PR}} + V_{\text{REF}})</math>) / (<math>\text{Sens}_{\text{IDEAL}} \times I_{\text{PR}} \times 100</math>) AND TOTAL ERROR COMPONENTS</b>						
Total Error	$E_{\text{TOT}}$	$I_{\text{P}} = I_{\text{PR}(\text{max})}$	–1.75	–0.5 ±0.6	1.75	%
Sensitivity Error	$E_{\text{SENS}}$	$I_{\text{P}} = I_{\text{PR}(\text{max})}$ , $T_A = 25^\circ\text{C}$ to $150^\circ\text{C}$ or $-40^\circ\text{C}$ to $25^\circ\text{C}$	–1.5	–0.5 ±0.6	1.5	%
Zero Current Reference Error	$V_{\text{RE}}$	$V_{\text{REFactual}} - V_{\text{REFideal}}$ , $I_{\text{P}} = 0 \text{ A}$ , $T_A = 25^\circ\text{C}$ to $150^\circ\text{C}$	–10	–2 ±3	10	mV
		$V_{\text{REFactual}} - V_{\text{REFideal}}$ , $I_{\text{P}} = 0 \text{ A}$ , $T_A = -40^\circ\text{C}$ to $25^\circ\text{C}$	–10	–1 ±3	10	mV
Offset Error	$V_{\text{OE}}$	$V_{\text{IOUT(Q)}} - V_{\text{REF}}$ , $I_{\text{P}} = 0 \text{ A}$ , $T_A = 25^\circ\text{C}$ to $150^\circ\text{C}$	–8	–1 ±4	8	mV
		$V_{\text{IOUT(Q)}} - V_{\text{REF}}$ , $I_{\text{P}} = 0 \text{ A}$ , $T_A = -40^\circ\text{C}$ to $25^\circ\text{C}$	–8	–1 ±3	8	mV
QVO Error	$V_{\text{QE}}$	$V_{\text{IOUT(Q)}}$ , $I_{\text{P}} = 0 \text{ A}$ , $T_A = 25^\circ\text{C}$ to $150^\circ\text{C}$	–10	–3 ±5	10	mV
		$V_{\text{IOUT(Q)}}$ , $I_{\text{P}} = 0 \text{ A}$ , $T_A = -40^\circ\text{C}$ to $25^\circ\text{C}$	–10	–1 ±4	10	mV
<b>TOTAL ERROR AND TOTAL ERROR COMPONENTS INCLUDING LIFETIME DRIFT [2,3]</b>						
Total Error Including Lifetime Drift	$E_{\text{TOT\_LTD}}$	$I_{\text{P}} = I_{\text{PR}(\text{max})}$	–3.6	–1.6 ±1.2	3.6	%
Sensitivity Error Including Lifetime Drift	$E_{\text{SENS\_LTD}}$	$I_{\text{P}} = I_{\text{PR}(\text{max})}$ , $T_A = 25^\circ\text{C}$ to $150^\circ\text{C}$ or $-40^\circ\text{C}$ to $25^\circ\text{C}$	–3.4	–1.5 ±1.1	3.4	%
Zero Current Reference Error Including Lifetime Drift	$V_{\text{RE\_LTD}}$	$V_{\text{REFactual}} - V_{\text{REFideal}}$ , $I_{\text{P}} = 0 \text{ A}$ , $T_A = 25^\circ\text{C}$ to $150^\circ\text{C}$	–10	–3 ±4	10	mV
		$V_{\text{REFactual}} - V_{\text{REFideal}}$ , $I_{\text{P}} = 0 \text{ A}$ , $T_A = -40^\circ\text{C}$ to $25^\circ\text{C}$	–10	–2 ±3	10	mV
Offset Error Including Lifetime Drift	$V_{\text{OE\_LTD}}$	$V_{\text{IOUT(Q)}} - V_{\text{REF}}$ , $I_{\text{P}} = 0 \text{ A}$ , $T_A = 25^\circ\text{C}$ to $150^\circ\text{C}$	–10	–2 ±5	10	mV
		$V_{\text{IOUT(Q)}} - V_{\text{REF}}$ , $I_{\text{P}} = 0 \text{ A}$ , $T_A = -40^\circ\text{C}$ to $25^\circ\text{C}$	–10	±4	10	mV
QVO Error Including Lifetime Drift	$V_{\text{QE\_LTD}}$	$V_{\text{IOUT(Q)}}$ , $I_{\text{P}} = 0 \text{ A}$ , $T_A = 25^\circ\text{C}$ to $150^\circ\text{C}$	–14	–4 ±6	14	mV
		$V_{\text{IOUT(Q)}}$ , $I_{\text{P}} = 0 \text{ A}$ , $T_A = -40^\circ\text{C}$ to $25^\circ\text{C}$	–10	±7	10	mV

[1] Typical values are the mean ±3 sigma of production distributions. These are formatted as mean ±3 sigma.

[2] Typical values are the mean ±3 sigma statistical combination of production and AEC-Q100 individual drift distributions. These are formatted as mean ±3 sigma.

[3] Lifetime drift characteristics are based on a statistical combination of production distributions and worst case distribution of parametric drift of individuals observed during AEC-Q100 qualification.

### ACS37002LMABTR-066U5-M

ACS37002LMABTR-066U5-M Gain\_Sel Pin Performance Key

				Selection Identifier
Parameter (Units)	Gain_Sel_1 (Boolean)	Gain_Sel_0 (Boolean)	Sens (mV/A)	Max IP (A)
Type	Digital Input	Digital Input	Calculation	Unidirectional
Selection Combination	0	0	60	66.7
	0	1	50	80
	1	0	40	100
	1	1	30	133.3

**ACS37002LMABTR-066U5-M PERFORMANCE CHARACTERISTICS:** Valid through full operating temperature range,  $T_A = -40^\circ\text{C}$  to  $150^\circ\text{C}$ ,  $C_{\text{BYPASS}} = 0.1 \mu\text{F}$ , and  $V_{\text{CC}} = 5 \text{ V}$ , unless otherwise specified

Characteristic	Symbol	Test Conditions	Min.	Typ. [1]	Max.	Units
<b>NOMINAL PERFORMANCE</b>						
Current Sensing Range	$I_{\text{PR}}$	Gain Sel 00	0	–	66.7	A
		Gain Sel 01	0	–	80	A
		Gain Sel 10	0	–	100	A
		Gain Sel 11	0	–	133.3	A
Sensitivity	Sens	Gain Sel 00; $I_{\text{PR}(\text{min})} < I_{\text{P}} < I_{\text{PR}(\text{max})}$	–	60	–	mV/A
		Gain Sel 01; $I_{\text{PR}(\text{min})} < I_{\text{P}} < I_{\text{PR}(\text{max})}$	–	50	–	mV/A
		Gain Sel 10; $I_{\text{PR}(\text{min})} < I_{\text{P}} < I_{\text{PR}(\text{max})}$	–	40	–	mV/A
		Gain Sel 11; $I_{\text{PR}(\text{min})} < I_{\text{P}} < I_{\text{PR}(\text{max})}$	–	30	–	mV/A
Overcurrent Fault Operating Range	$I_{\text{OCF-OR}}$	Typ. = factory-programmed default, FS = Full-Scale	25	50	100	%FS
Zero Current Output Voltage	$V_{\text{IOUT(Q)}}$	Unidirectional; $I_{\text{P}} = 0 \text{ A}$ , $T_A = 25^\circ\text{C}$	–	0.5	–	V
<b>TOTAL ERROR (<math>V_{\text{IOUT(ACTUAL)}} - (\text{Sens}_{\text{IDEAL}} \times I_{\text{PR}} + V_{\text{REF}})</math>) / (<math>\text{Sens}_{\text{IDEAL}} \times I_{\text{PR}}</math>) × 100 AND TOTAL ERROR COMPONENTS</b>						
Total Error	$E_{\text{TOT}}$	$I_{\text{P}} = I_{\text{PR}(\text{max})}$	–1.75	–0.5 ±0.6	1.75	%
Sensitivity Error	$E_{\text{SENS}}$	$I_{\text{P}} = I_{\text{PR}(\text{max})}$ , $T_A = 25^\circ\text{C}$ to $150^\circ\text{C}$ or $-40^\circ\text{C}$ to $25^\circ\text{C}$	–1.5	–0.5 ±0.6	1.5	%
Zero Current Reference Error	$V_{\text{RE}}$	$V_{\text{REFactual}} - V_{\text{REFideal}}$ , $I_{\text{P}} = 0 \text{ A}$ , $T_A = 25^\circ\text{C}$ to $150^\circ\text{C}$	–10	–2 ±3	10	mV
		$V_{\text{REFactual}} - V_{\text{REFideal}}$ , $I_{\text{P}} = 0 \text{ A}$ , $T_A = -40^\circ\text{C}$ to $25^\circ\text{C}$	–10	–1 ±3	10	mV
Offset Error	$V_{\text{OE}}$	$V_{\text{IOUT(Q)}} - V_{\text{REF}}$ , $I_{\text{P}} = 0 \text{ A}$ , $T_A = 25^\circ\text{C}$ to $150^\circ\text{C}$	–8	–1 ±4	8	mV
		$V_{\text{IOUT(Q)}} - V_{\text{REF}}$ , $I_{\text{P}} = 0 \text{ A}$ , $T_A = -40^\circ\text{C}$ to $25^\circ\text{C}$	–8	–1 ±3	8	mV
QVO Error	$V_{\text{QE}}$	$V_{\text{IOUT(Q)}}$ , $I_{\text{P}} = 0 \text{ A}$ , $T_A = 25^\circ\text{C}$ to $150^\circ\text{C}$	–10	–3 ±5	10	mV
		$V_{\text{IOUT(Q)}}$ , $I_{\text{P}} = 0 \text{ A}$ , $T_A = -40^\circ\text{C}$ to $25^\circ\text{C}$	–10	–1 ±4	10	mV
<b>TOTAL ERROR AND TOTAL ERROR COMPONENTS INCLUDING LIFETIME DRIFT [2,3]</b>						
Total Error Including Lifetime Drift	$E_{\text{TOT\_LTD}}$	$I_{\text{P}} = I_{\text{PR}(\text{max})}$	–3.6	–1.6 ±1.2	3.6	%
Sensitivity Error Including Lifetime Drift	$E_{\text{SENS\_LTD}}$	$I_{\text{P}} = I_{\text{PR}(\text{max})}$ , $T_A = 25^\circ\text{C}$ to $150^\circ\text{C}$ or $-40^\circ\text{C}$ to $25^\circ\text{C}$	–3.4	–1.5 ±1.1	3.4	%
Zero Current Reference Error Including Lifetime Drift	$V_{\text{RE\_LTD}}$	$V_{\text{REFactual}} - V_{\text{REFideal}}$ , $I_{\text{P}} = 0 \text{ A}$ , $T_A = 25^\circ\text{C}$ to $150^\circ\text{C}$	–10	–3 ±4	10	mV
		$V_{\text{REFactual}} - V_{\text{REFideal}}$ , $I_{\text{P}} = 0 \text{ A}$ , $T_A = -40^\circ\text{C}$ to $25^\circ\text{C}$	–10	–2 ±3	10	mV
Offset Error Including Lifetime Drift	$V_{\text{OE\_LTD}}$	$V_{\text{IOUT(Q)}} - V_{\text{REF}}$ , $I_{\text{P}} = 0 \text{ A}$ , $T_A = 25^\circ\text{C}$ to $150^\circ\text{C}$	–10	–2 ±5	10	mV
		$V_{\text{IOUT(Q)}} - V_{\text{REF}}$ , $I_{\text{P}} = 0 \text{ A}$ , $T_A = -40^\circ\text{C}$ to $25^\circ\text{C}$	–10	±4	10	mV
QVO Error Including Lifetime Drift	$V_{\text{QE\_LTD}}$	$V_{\text{IOUT(Q)}}$ , $I_{\text{P}} = 0 \text{ A}$ , $T_A = 25^\circ\text{C}$ to $150^\circ\text{C}$	–14	–4 ±6	14	mV
		$V_{\text{IOUT(Q)}}$ , $I_{\text{P}} = 0 \text{ A}$ , $T_A = -40^\circ\text{C}$ to $25^\circ\text{C}$	–10	±7	10	mV

[1] Typical values are the mean ±3 sigma of production distributions. These are formatted as mean ±3 sigma.

[2] Typical values are the mean ±3 sigma statistical combination of production and AEC-Q100 individual drift distributions. These are formatted as mean ±3 sigma.

[3] Lifetime drift characteristics are based on a statistical combination of production distributions and worst case distribution of parametric drift of individuals observed during AEC-Q100 qualification.

## ACS37002LMABTR-050B3

ACS37002LMABTR-050B3 Gain\_Sel Pin Performance Key

				Selection Identifier
Parameter (Units)	Gain_Sel_1 (Boolean)	Gain_Sel_0 (Boolean)	Sens (mV/A)	Max IP (A)
Type	Digital Input	Digital Input	Calculation	Bidirectional
Selection Combination	0	0	26.4	50
	0	1	33	40
	1	0	39.6	33.3
	1	1	19.8	66.7

**ACS37002LMABTR-050B3 PERFORMANCE CHARACTERISTICS:** Valid through full operating temperature range,  $T_A = -40^\circ\text{C}$  to  $150^\circ\text{C}$ ,  $C_{\text{BYPASS}} = 0.1 \mu\text{F}$ , and  $V_{\text{CC}} = 3.3 \text{ V}$ , unless otherwise specified

Characteristic	Symbol	Test Conditions	Min.	Typ. [1]	Max.	Units
<b>NOMINAL PERFORMANCE</b>						
Current Sensing Range	$I_{\text{PR}}$	Gain Sel 00	-50	-	50	A
		Gain Sel 01	-40	-	40	A
		Gain Sel 10	-33.3	-	33.3	A
		Gain Sel 11	-66.7	-	66.7	A
Sensitivity	Sens	Gain Sel 00; $I_{\text{PR}(\text{min})} < I_{\text{P}} < I_{\text{PR}(\text{max})}$	-	26.4	-	mV/A
		Gain Sel 01; $I_{\text{PR}(\text{min})} < I_{\text{P}} < I_{\text{PR}(\text{max})}$	-	33	-	mV/A
		Gain Sel 10; $I_{\text{PR}(\text{min})} < I_{\text{P}} < I_{\text{PR}(\text{max})}$	-	39.6	-	mV/A
		Gain Sel 11; $I_{\text{PR}(\text{min})} < I_{\text{P}} < I_{\text{PR}(\text{max})}$	-	19.8	-	mV/A
Overcurrent Fault Operating Range	$I_{\text{OCF-OR}}$	Typ. = factory-programmed default, FS = Full-Scale	50	100	200	%FS
Zero Current Output Voltage	$V_{\text{IOUT}(Q)}$	Bidirectional; $I_{\text{P}} = 0 \text{ A}$ , $T_A = 25^\circ\text{C}$	-	1.65	-	V
<b>TOTAL ERROR (<math>V_{\text{IOUT}(\text{ACTUAL})} - (\text{Sens}_{(\text{IDEAL})} \times I_{\text{PR}} + V_{\text{REF}})</math>) / (<math>\text{Sens}_{(\text{IDEAL})} \times I_{\text{PR}}</math>) × 100 AND TOTAL ERROR COMPONENTS</b>						
Total Error	$E_{\text{TOT}}$	$I_{\text{P}} = I_{\text{PR}(\text{max})}$	-1.75	-0.5 ±0.6	1.75	%
Sensitivity Error	$E_{\text{SENS}}$	$I_{\text{P}} = I_{\text{PR}(\text{max})}$ , $T_A = 25^\circ\text{C}$ to $150^\circ\text{C}$ or $-40^\circ\text{C}$ to $25^\circ\text{C}$	-1.5	-0.5 ±0.6	1.5	%
Zero Current Reference Error	$V_{\text{RE}}$	$V_{\text{REFactual}} - V_{\text{REFideal}}$ , $I_{\text{P}} = 0 \text{ A}$ , $T_A = 25^\circ\text{C}$ to $150^\circ\text{C}$	-10	-2 ±3	10	mV
		$V_{\text{REFactual}} - V_{\text{REFideal}}$ , $I_{\text{P}} = 0 \text{ A}$ , $T_A = -40^\circ\text{C}$ to $25^\circ\text{C}$	-10	-1 ±3	10	mV
Offset Error	$V_{\text{OE}}$	$V_{\text{IOUT}(Q)} - V_{\text{REF}}$ , $I_{\text{P}} = 0 \text{ A}$ , $T_A = 25^\circ\text{C}$ to $150^\circ\text{C}$	-8	-1 ±4	8	mV
		$V_{\text{IOUT}(Q)} - V_{\text{REF}}$ , $I_{\text{P}} = 0 \text{ A}$ , $T_A = -40^\circ\text{C}$ to $25^\circ\text{C}$	-8	-1 ±3	8	mV
QVO Error	$V_{\text{QE}}$	$V_{\text{IOUT}(Q)}$ , $I_{\text{P}} = 0 \text{ A}$ , $T_A = 25^\circ\text{C}$ to $150^\circ\text{C}$	-10	-3 ±5	10	mV
		$V_{\text{IOUT}(Q)}$ , $I_{\text{P}} = 0 \text{ A}$ , $T_A = -40^\circ\text{C}$ to $25^\circ\text{C}$	-10	-1 ±4	10	mV
<b>TOTAL ERROR AND TOTAL ERROR COMPONENTS INCLUDING LIFETIME DRIFT [2,3]</b>						
Total Error Including Lifetime Drift	$E_{\text{TOT\_LTD}}$	$I_{\text{P}} = I_{\text{PR}(\text{max})}$	-3.6	-1.6 ±1.2	3.6	%
Sensitivity Error Including Lifetime Drift	$E_{\text{SENS\_LTD}}$	$I_{\text{P}} = I_{\text{PR}(\text{max})}$ , $T_A = 25^\circ\text{C}$ to $150^\circ\text{C}$ or $-40^\circ\text{C}$ to $25^\circ\text{C}$	-3.4	-1.5 ±1.1	3.4	%
Zero Current Reference Error Including Lifetime Drift	$V_{\text{RE\_LTD}}$	$V_{\text{REFactual}} - V_{\text{REFideal}}$ , $I_{\text{P}} = 0 \text{ A}$ , $T_A = 25^\circ\text{C}$ to $150^\circ\text{C}$	-10	-3 ±4	10	mV
		$V_{\text{REFactual}} - V_{\text{REFideal}}$ , $I_{\text{P}} = 0 \text{ A}$ , $T_A = -40^\circ\text{C}$ to $25^\circ\text{C}$	-10	-2 ±3	10	mV
Offset Error Including Lifetime Drift	$V_{\text{OE\_LTD}}$	$V_{\text{IOUT}(Q)} - V_{\text{REF}}$ , $I_{\text{P}} = 0 \text{ A}$ , $T_A = 25^\circ\text{C}$ to $150^\circ\text{C}$	-10	-2 ±5	10	mV
		$V_{\text{IOUT}(Q)} - V_{\text{REF}}$ , $I_{\text{P}} = 0 \text{ A}$ , $T_A = -40^\circ\text{C}$ to $25^\circ\text{C}$	-10	±4	10	mV
QVO Error Including Lifetime Drift	$V_{\text{QE\_LTD}}$	$V_{\text{IOUT}(Q)}$ , $I_{\text{P}} = 0 \text{ A}$ , $T_A = 25^\circ\text{C}$ to $150^\circ\text{C}$	-14	-4 ±6	14	mV
		$V_{\text{IOUT}(Q)}$ , $I_{\text{P}} = 0 \text{ A}$ , $T_A = -40^\circ\text{C}$ to $25^\circ\text{C}$	-10	±7	10	mV

[1] Typical values are the mean ±3 sigma of production distributions. These are formatted as mean ±3 sigma.

[2] Typical values are the mean ±3 sigma statistical combination of production and AEC-Q100 individual drift distributions. These are formatted as mean ±3 sigma.

[3] Lifetime drift characteristics are based on a statistical combination of production distributions and worst case distribution of parametric drift of individuals observed during AEC-Q100 qualification.



## ACS37002LMABTR-066B3

ACS37002LMABTR-066B3 Gain\_Sel Pin Performance Key

				Selection Identifier
Parameter (Units)	Gain_Sel_1 (Boolean)	Gain_Sel_0 (Boolean)	Sens (mV/A)	Max IP (A)
Type	Digital Input	Digital Input	Calculation	Bidirectional
Selection Combination	0	0	19.8	66.7
	0	1	16.5	80
	1	0	13.2	100
	1	1	9.9	133.3

**ACS37002LMABTR-066B3 PERFORMANCE CHARACTERISTICS:** Valid through full operating temperature range,  $T_A = -40^\circ\text{C}$  to  $150^\circ\text{C}$ ,  $C_{\text{BYPASS}} = 0.1 \mu\text{F}$ , and  $V_{\text{CC}} = 3.3 \text{ V}$ , unless otherwise specified

Characteristic	Symbol	Test Conditions	Min.	Typ. [1]	Max.	Units
<b>NOMINAL PERFORMANCE</b>						
Current Sensing Range	$I_{\text{PR}}$	Gain Sel 00	-66.7	-	66.7	A
		Gain Sel 01	-80	-	80	A
		Gain Sel 10	-100	-	100	A
		Gain Sel 11	-133.3	-	133.3	A
Sensitivity	Sens	Gain Sel 00; $I_{\text{PR}(\text{min})} < I_{\text{P}} < I_{\text{PR}(\text{max})}$	-	19.8	-	mV/A
		Gain Sel 01; $I_{\text{PR}(\text{min})} < I_{\text{P}} < I_{\text{PR}(\text{max})}$	-	16.5	-	mV/A
		Gain Sel 10; $I_{\text{PR}(\text{min})} < I_{\text{P}} < I_{\text{PR}(\text{max})}$	-	13.2	-	mV/A
		Gain Sel 11; $I_{\text{PR}(\text{min})} < I_{\text{P}} < I_{\text{PR}(\text{max})}$	-	9.9	-	mV/A
Overcurrent Fault Operating Range	$I_{\text{OCF-OR}}$	Typ. = factory-programmed default, FS = Full-Scale	50	100	200	%FS
Zero Current Output Voltage	$V_{\text{IOUT(Q)}}$	Bidirectional; $I_{\text{P}} = 0 \text{ A}$ , $T_A = 25^\circ\text{C}$	-	1.65	-	V
<b>TOTAL ERROR (<math>V_{\text{IOUT(ACTUAL)}} - (\text{Sens}_{(\text{IDEAL})} \times I_{\text{PR}} + V_{\text{REF}})</math>) / (<math>\text{Sens}_{(\text{IDEAL})} \times I_{\text{PR}})</math> × 100 AND TOTAL ERROR COMPONENTS</b>						
Total Error	$E_{\text{TOT}}$	$I_{\text{P}} = I_{\text{PR}(\text{max})}$	-1.75	-0.5 ±0.6	1.75	%
Sensitivity Error	$E_{\text{SENS}}$	$I_{\text{P}} = I_{\text{PR}(\text{max})}$ , $T_A = 25^\circ\text{C}$ to $150^\circ\text{C}$ or $-40^\circ\text{C}$ to $25^\circ\text{C}$	-1.5	-0.5 ±0.6	1.5	%
Zero Current Reference Error	$V_{\text{RE}}$	$V_{\text{REFactual}} - V_{\text{REFideal}}$ , $I_{\text{P}} = 0 \text{ A}$ , $T_A = 25^\circ\text{C}$ to $150^\circ\text{C}$	-10	-2 ±3	10	mV
		$V_{\text{REFactual}} - V_{\text{REFideal}}$ , $I_{\text{P}} = 0 \text{ A}$ , $T_A = -40^\circ\text{C}$ to $25^\circ\text{C}$	-10	-1 ±3	10	mV
Offset Error	$V_{\text{OE}}$	$V_{\text{IOUT(Q)}} - V_{\text{REF}}$ , $I_{\text{P}} = 0 \text{ A}$ , $T_A = 25^\circ\text{C}$ to $150^\circ\text{C}$	-8	-1 ±4	8	mV
		$V_{\text{IOUT(Q)}} - V_{\text{REF}}$ , $I_{\text{P}} = 0 \text{ A}$ , $T_A = -40^\circ\text{C}$ to $25^\circ\text{C}$	-8	-1 ±3	8	mV
QVO Error	$V_{\text{QE}}$	$V_{\text{IOUT(Q)}}$ , $I_{\text{P}} = 0 \text{ A}$ , $T_A = 25^\circ\text{C}$ to $150^\circ\text{C}$	-10	-3 ±5	10	mV
		$V_{\text{IOUT(Q)}}$ , $I_{\text{P}} = 0 \text{ A}$ , $T_A = -40^\circ\text{C}$ to $25^\circ\text{C}$	-10	-1 ±4	10	mV
<b>TOTAL ERROR AND TOTAL ERROR COMPONENTS INCLUDING LIFETIME DRIFT [2,3]</b>						
Total Error Including Lifetime Drift	$E_{\text{TOT\_LTD}}$	$I_{\text{P}} = I_{\text{PR}(\text{max})}$	-3.6	-1.6 ±1.2	3.6	%
Sensitivity Error Including Lifetime Drift	$E_{\text{SENS\_LTD}}$	$I_{\text{P}} = I_{\text{PR}(\text{max})}$ , $T_A = 25^\circ\text{C}$ to $150^\circ\text{C}$ or $-40^\circ\text{C}$ to $25^\circ\text{C}$	-3.4	-1.5 ±1.1	3.4	%
Zero Current Reference Error Including Lifetime Drift	$V_{\text{RE\_LTD}}$	$V_{\text{REFactual}} - V_{\text{REFideal}}$ , $I_{\text{P}} = 0 \text{ A}$ , $T_A = 25^\circ\text{C}$ to $150^\circ\text{C}$	-10	-3 ±4	10	mV
		$V_{\text{REFactual}} - V_{\text{REFideal}}$ , $I_{\text{P}} = 0 \text{ A}$ , $T_A = -40^\circ\text{C}$ to $25^\circ\text{C}$	-10	-2 ±3	10	mV
Offset Error Including Lifetime Drift	$V_{\text{OE\_LTD}}$	$V_{\text{IOUT(Q)}} - V_{\text{REF}}$ , $I_{\text{P}} = 0 \text{ A}$ , $T_A = 25^\circ\text{C}$ to $150^\circ\text{C}$	-10	-2 ±5	10	mV
		$V_{\text{IOUT(Q)}} - V_{\text{REF}}$ , $I_{\text{P}} = 0 \text{ A}$ , $T_A = -40^\circ\text{C}$ to $25^\circ\text{C}$	-10	±4	10	mV
QVO Error Including Lifetime Drift	$V_{\text{QE\_LTD}}$	$V_{\text{IOUT(Q)}}$ , $I_{\text{P}} = 0 \text{ A}$ , $T_A = 25^\circ\text{C}$ to $150^\circ\text{C}$	-14	-4 ±6	14	mV
		$V_{\text{IOUT(Q)}}$ , $I_{\text{P}} = 0 \text{ A}$ , $T_A = -40^\circ\text{C}$ to $25^\circ\text{C}$	-10	±7	10	mV

[1] Typical values are the mean ±3 sigma of production distributions. These are formatted as mean ±3 sigma.

[2] Typical values are the mean ±3 sigma statistical combination of production and AEC-Q100 individual drift distributions. These are formatted as mean ±3 sigma.

[3] Lifetime drift characteristics are based on a statistical combination of production distributions and worst case distribution of parametric drift of individuals observed during AEC-Q100 qualification.



## ACS37002LMABTR-050U3

ACS37002LMABTR-050U3 Gain\_Sel Pin Performance Key

				Selection Identifier
Parameter (Units)	Gain_Sel_1 (Boolean)	Gain_Sel_0 (Boolean)	Sens (mV/A)	Max IP (A)
Type	Digital Input	Digital Input	Calculation	Unidirectional
Selection Combination	0	0	52.8	50
	0	1	66	40
	1	0	79.2	33.3
	1	1	39.6	66.7

**ACS37002LMABTR-050U3 PERFORMANCE CHARACTERISTICS:** Valid through full operating temperature range,  $T_A = -40^\circ\text{C}$  to  $150^\circ\text{C}$ ,  $C_{\text{BYPASS}} = 0.1 \mu\text{F}$ , and  $V_{\text{CC}} = 3.3 \text{ V}$ , unless otherwise specified

Characteristic	Symbol	Test Conditions	Min.	Typ. [1]	Max.	Units
<b>NOMINAL PERFORMANCE</b>						
Current Sensing Range	$I_{\text{PR}}$	Gain Sel 00	0	–	50	A
		Gain Sel 01	0	–	40	A
		Gain Sel 10	0	–	33.3	A
		Gain Sel 11	0	–	66.7	A
Sensitivity	Sens	Gain Sel 00; $I_{\text{PR}(\text{min})} < I_{\text{P}} < I_{\text{PR}(\text{max})}$	–	52.8	–	mV/A
		Gain Sel 01; $I_{\text{PR}(\text{min})} < I_{\text{P}} < I_{\text{PR}(\text{max})}$	–	66	–	mV/A
		Gain Sel 10; $I_{\text{PR}(\text{min})} < I_{\text{P}} < I_{\text{PR}(\text{max})}$	–	79.2	–	mV/A
		Gain Sel 11; $I_{\text{PR}(\text{min})} < I_{\text{P}} < I_{\text{PR}(\text{max})}$	–	39.6	–	mV/A
Overcurrent Fault Operating Range	$I_{\text{OCF-OR}}$	Typ. = factory-programmed default, FS = Full-Scale	25	50	100	%FS
Zero Current Output Voltage	$V_{\text{IOUT(Q)}}$	Unidirectional; $I_{\text{P}} = 0 \text{ A}$ , $T_A = 25^\circ\text{C}$	–	0.33	–	V
<b>TOTAL ERROR (<math>V_{\text{IOUT(ACTUAL)}} - (\text{Sens}_{\text{IDEAL}} \times I_{\text{PR}} + V_{\text{REF}})</math>) / (<math>\text{Sens}_{\text{IDEAL}} \times I_{\text{PR}}</math>) × 100 AND TOTAL ERROR COMPONENTS</b>						
Total Error	$E_{\text{TOT}}$	$I_{\text{P}} = I_{\text{PR}(\text{max})}$	–1.75	–0.5 ±0.6	1.75	%
Sensitivity Error	$E_{\text{SENS}}$	$I_{\text{P}} = I_{\text{PR}(\text{max})}$ , $T_A = 25^\circ\text{C}$ to $150^\circ\text{C}$ or $-40^\circ\text{C}$ to $25^\circ\text{C}$	–1.5	–0.5 ±0.6	1.5	%
Zero Current Reference Error	$V_{\text{RE}}$	$V_{\text{REFactual}} - V_{\text{REFideal}}$ , $I_{\text{P}} = 0 \text{ A}$ , $T_A = 25^\circ\text{C}$ to $150^\circ\text{C}$	–10	–2 ±3	10	mV
		$V_{\text{REFactual}} - V_{\text{REFideal}}$ , $I_{\text{P}} = 0 \text{ A}$ , $T_A = -40^\circ\text{C}$ to $25^\circ\text{C}$	–10	–1 ±3	10	mV
Offset Error	$V_{\text{OE}}$	$V_{\text{IOUT(Q)}} - V_{\text{REF}}$ , $I_{\text{P}} = 0 \text{ A}$ , $T_A = 25^\circ\text{C}$ to $150^\circ\text{C}$	–8	–1 ±4	8	mV
		$V_{\text{IOUT(Q)}} - V_{\text{REF}}$ , $I_{\text{P}} = 0 \text{ A}$ , $T_A = -40^\circ\text{C}$ to $25^\circ\text{C}$	–8	–1 ±3	8	mV
QVO Error	$V_{\text{QE}}$	$V_{\text{IOUT(Q)}}$ , $I_{\text{P}} = 0 \text{ A}$ , $T_A = 25^\circ\text{C}$ to $150^\circ\text{C}$	–10	–3 ±5	10	mV
		$V_{\text{IOUT(Q)}}$ , $I_{\text{P}} = 0 \text{ A}$ , $T_A = -40^\circ\text{C}$ to $25^\circ\text{C}$	–10	–1 ±4	10	mV
<b>TOTAL ERROR AND TOTAL ERROR COMPONENTS INCLUDING LIFETIME DRIFT [2,3]</b>						
Total Error Including Lifetime Drift	$E_{\text{TOT\_LTD}}$	$I_{\text{P}} = I_{\text{PR}(\text{max})}$	–3.6	–1.6 ±1.2	3.6	%
Sensitivity Error Including Lifetime Drift	$E_{\text{SENS\_LTD}}$	$I_{\text{P}} = I_{\text{PR}(\text{max})}$ , $T_A = 25^\circ\text{C}$ to $150^\circ\text{C}$ or $-40^\circ\text{C}$ to $25^\circ\text{C}$	–3.4	–1.5 ±1.1	3.4	%
Zero Current Reference Error Including Lifetime Drift	$V_{\text{RE\_LTD}}$	$V_{\text{REFactual}} - V_{\text{REFideal}}$ , $I_{\text{P}} = 0 \text{ A}$ , $T_A = 25^\circ\text{C}$ to $150^\circ\text{C}$	–10	–3 ±4	10	mV
		$V_{\text{REFactual}} - V_{\text{REFideal}}$ , $I_{\text{P}} = 0 \text{ A}$ , $T_A = -40^\circ\text{C}$ to $25^\circ\text{C}$	–10	–2 ±3	10	mV
Offset Error Including Lifetime Drift	$V_{\text{OE\_LTD}}$	$V_{\text{IOUT(Q)}} - V_{\text{REF}}$ , $I_{\text{P}} = 0 \text{ A}$ , $T_A = 25^\circ\text{C}$ to $150^\circ\text{C}$	–10	–2 ±5	10	mV
		$V_{\text{IOUT(Q)}} - V_{\text{REF}}$ , $I_{\text{P}} = 0 \text{ A}$ , $T_A = -40^\circ\text{C}$ to $25^\circ\text{C}$	–10	±4	10	mV
QVO Error Including Lifetime Drift	$V_{\text{QE\_LTD}}$	$V_{\text{IOUT(Q)}}$ , $I_{\text{P}} = 0 \text{ A}$ , $T_A = 25^\circ\text{C}$ to $150^\circ\text{C}$	–14	–4 ±6	14	mV
		$V_{\text{IOUT(Q)}}$ , $I_{\text{P}} = 0 \text{ A}$ , $T_A = -40^\circ\text{C}$ to $25^\circ\text{C}$	–10	±7	10	mV

[1] Typical values are the mean ±3 sigma of production distributions. These are formatted as mean ±3 sigma.

[2] Typical values are the mean ±3 sigma statistical combination of production and AEC-Q100 individual drift distributions. These are formatted as mean ±3 sigma.

[3] Lifetime drift characteristics are based on a statistical combination of production distributions and worst case distribution of parametric drift of individuals observed during AEC-Q100 qualification.

### ACS37002LMABTR-066U3

#### ACS37002LMABTR-066U3 Gain\_Sel Pin Performance Key

				Selection Identifier	
Parameter (Units)	Gain_Sel_1 (Boolean)	Gain_Sel_0 (Boolean)	Sens (mV/A)	Max IP (A)	
Type	Digital Input	Digital Input	Calculation	Unidirectional	
Selection Combination	0	0	39.6	66.7	
	0	1	33	80	
	1	0	26.4	100	
	1	1	19.8	133.3	

**ACS37002LMABTR-066U3 PERFORMANCE CHARACTERISTICS:** Valid through full operating temperature range,  $T_A = -40^\circ\text{C}$  to  $150^\circ\text{C}$ ,  $C_{\text{BYPASS}} = 0.1 \mu\text{F}$ , and  $V_{\text{CC}} = 3.3 \text{ V}$ , unless otherwise specified

Characteristic	Symbol	Test Conditions	Min.	Typ. [1]	Max.	Units
<b>NOMINAL PERFORMANCE</b>						
Current Sensing Range	$I_{\text{PR}}$	Gain Sel 00	0	–	66.7	A
		Gain Sel 01	0	–	80	A
		Gain Sel 10	0	–	100	A
		Gain Sel 11	0	–	133.3	A
Sensitivity	Sens	Gain Sel 00; $I_{\text{PR}(\text{min})} < I_{\text{P}} < I_{\text{PR}(\text{max})}$	–	39.6	–	mV/A
		Gain Sel 01; $I_{\text{PR}(\text{min})} < I_{\text{P}} < I_{\text{PR}(\text{max})}$	–	33	–	mV/A
		Gain Sel 10; $I_{\text{PR}(\text{min})} < I_{\text{P}} < I_{\text{PR}(\text{max})}$	–	26.4	–	mV/A
		Gain Sel 11; $I_{\text{PR}(\text{min})} < I_{\text{P}} < I_{\text{PR}(\text{max})}$	–	19.8	–	mV/A
Overcurrent Fault Operating Range	$I_{\text{OCF-OR}}$	Typ. = factory-programmed default, FS = Full-Scale	25	50	100	%FS
Zero Current Output Voltage	$V_{\text{IOUT(Q)}}$	Unidirectional; $I_{\text{P}} = 0 \text{ A}$ , $T_A = 25^\circ\text{C}$	–	0.33	–	V
<b>TOTAL ERROR (<math>V_{\text{IOUT(ACTUAL)}} - (\text{Sens}_{(\text{IDEAL})} \times I_{\text{PR}} + V_{\text{REF}})</math>) / (<math>\text{Sens}_{(\text{IDEAL})} \times I_{\text{PR}}) \times 100</math> AND TOTAL ERROR COMPONENTS</b>						
Total Error	$E_{\text{TOT}}$	$I_{\text{P}} = I_{\text{PR}(\text{max})}$	–1.75	–0.5 ±0.6	1.75	%
Sensitivity Error	$E_{\text{SENS}}$	$I_{\text{P}} = I_{\text{PR}(\text{max})}$ , $T_A = 25^\circ\text{C}$ to $150^\circ\text{C}$ or $-40^\circ\text{C}$ to $25^\circ\text{C}$	–1.5	–0.5 ±0.6	1.5	%
Zero Current Reference Error	$V_{\text{RE}}$	$V_{\text{REFactual}} - V_{\text{REFideal}}$ , $I_{\text{P}} = 0 \text{ A}$ , $T_A = 25^\circ\text{C}$ to $150^\circ\text{C}$	–10	–2 ±3	10	mV
		$V_{\text{REFactual}} - V_{\text{REFideal}}$ , $I_{\text{P}} = 0 \text{ A}$ , $T_A = -40^\circ\text{C}$ to $25^\circ\text{C}$	–10	–1 ±3	10	mV
Offset Error	$V_{\text{OE}}$	$V_{\text{IOUT(Q)}} - V_{\text{REF}}$ , $I_{\text{P}} = 0 \text{ A}$ , $T_A = 25^\circ\text{C}$ to $150^\circ\text{C}$	–8	–1 ±4	8	mV
		$V_{\text{IOUT(Q)}} - V_{\text{REF}}$ , $I_{\text{P}} = 0 \text{ A}$ , $T_A = -40^\circ\text{C}$ to $25^\circ\text{C}$	–8	–1 ±3	8	mV
QVO Error	$V_{\text{QE}}$	$V_{\text{IOUT(Q)}}$ , $I_{\text{P}} = 0 \text{ A}$ , $T_A = 25^\circ\text{C}$ to $150^\circ\text{C}$	–10	–3 ±5	10	mV
		$V_{\text{IOUT(Q)}}$ , $I_{\text{P}} = 0 \text{ A}$ , $T_A = -40^\circ\text{C}$ to $25^\circ\text{C}$	–10	–1 ±4	10	mV
<b>TOTAL ERROR AND TOTAL ERROR COMPONENTS INCLUDING LIFETIME DRIFT [2,3]</b>						
Total Error Including Lifetime Drift	$E_{\text{TOT\_LTD}}$	$I_{\text{P}} = I_{\text{PR}(\text{max})}$	–3.6	–1.6 ±1.2	3.6	%
Sensitivity Error Including Lifetime Drift	$E_{\text{SENS\_LTD}}$	$I_{\text{P}} = I_{\text{PR}(\text{max})}$ , $T_A = 25^\circ\text{C}$ to $150^\circ\text{C}$ or $-40^\circ\text{C}$ to $25^\circ\text{C}$	–3.4	–1.5 ±1.1	3.4	%
Zero Current Reference Error Including Lifetime Drift	$V_{\text{RE\_LTD}}$	$V_{\text{REFactual}} - V_{\text{REFideal}}$ , $I_{\text{P}} = 0 \text{ A}$ , $T_A = 25^\circ\text{C}$ to $150^\circ\text{C}$	–10	–3 ±4	10	mV
		$V_{\text{REFactual}} - V_{\text{REFideal}}$ , $I_{\text{P}} = 0 \text{ A}$ , $T_A = -40^\circ\text{C}$ to $25^\circ\text{C}$	–10	–2 ±3	10	mV
Offset Error Including Lifetime Drift	$V_{\text{OE\_LTD}}$	$V_{\text{IOUT(Q)}} - V_{\text{REF}}$ , $I_{\text{P}} = 0 \text{ A}$ , $T_A = 25^\circ\text{C}$ to $150^\circ\text{C}$	–10	–2 ±5	10	mV
		$V_{\text{IOUT(Q)}} - V_{\text{REF}}$ , $I_{\text{P}} = 0 \text{ A}$ , $T_A = -40^\circ\text{C}$ to $25^\circ\text{C}$	–10	±4	10	mV
QVO Error Including Lifetime Drift	$V_{\text{QE\_LTD}}$	$V_{\text{IOUT(Q)}}$ , $I_{\text{P}} = 0 \text{ A}$ , $T_A = 25^\circ\text{C}$ to $150^\circ\text{C}$	–14	–4 ±6	14	mV
		$V_{\text{IOUT(Q)}}$ , $I_{\text{P}} = 0 \text{ A}$ , $T_A = -40^\circ\text{C}$ to $25^\circ\text{C}$	–10	±7	10	mV

[1] Typical values are the mean ±3 sigma of production distributions. These are formatted as mean ±3 sigma.

[2] Typical values are the mean ±3 sigma statistical combination of production and AEC-Q100 individual drift distributions. These are formatted as mean ±3 sigma.

[3] Lifetime drift characteristics are based on a statistical combination of production distributions and worst case distribution of parametric drift of individuals observed during AEC-Q100 qualification.

### ACS37002KMABTR-050B5-M

#### AACS37002KMABTR-050B5-M Gain\_Sel Pin Performance Key

				Selection Identifier	
Parameter (Units)	Gain_Sel_1 (Boolean)	Gain_Sel_0 (Boolean)	Sens (mV/A)	Max IP (A)	
Type	Digital Input	Digital Input	Calculation	Bidirectional	
Selection Combination	0	0	40	50	
	0	1	50	40	
	1	0	60	33.3	
	1	1	30	66.7	

**ACS37002KMABTR-050B5-M PERFORMANCE CHARACTERISTICS:** Valid through full operating temperature range,  $T_A = -40^\circ\text{C}$  to  $125^\circ\text{C}$ ,  $C_{\text{BYPASS}} = 0.1 \mu\text{F}$ , and  $V_{\text{CC}} = 5 \text{ V}$ , unless otherwise specified

Characteristic	Symbol	Test Conditions	Min.	Typ. [1]	Max.	Units
<b>NOMINAL PERFORMANCE</b>						
Current Sensing Range	$I_{\text{PR}}$	Gain Sel 00	-50	-	50	A
		Gain Sel 01	-40	-	40	A
		Gain Sel 10	-33.3	-	33.3	A
		Gain Sel 11	-66.7	-	66.7	A
Sensitivity	Sens	Gain Sel 00; $I_{\text{PR}(\text{min})} < I_{\text{P}} < I_{\text{PR}(\text{max})}$	-	40	-	mV/A
		Gain Sel 01; $I_{\text{PR}(\text{min})} < I_{\text{P}} < I_{\text{PR}(\text{max})}$	-	50	-	mV/A
		Gain Sel 10; $I_{\text{PR}(\text{min})} < I_{\text{P}} < I_{\text{PR}(\text{max})}$	-	60	-	mV/A
		Gain Sel 11; $I_{\text{PR}(\text{min})} < I_{\text{P}} < I_{\text{PR}(\text{max})}$	-	30	-	mV/A
Overcurrent Fault Operating Range	$I_{\text{OCF-OR}}$	Typ. = factory-programmed default, FS = Full-Scale	50	100	200	%FS
Zero Current Output Voltage	$V_{\text{IOUT(Q)}}$	Bidirectional; $I_{\text{P}} = 0 \text{ A}$ , $T_A = 25^\circ\text{C}$	-	2.5	-	V
<b>TOTAL ERROR (<math>V_{\text{IOUT(ACTUAL)}} - (\text{Sens}_{\text{IDEAL}} \times I_{\text{PR}} + V_{\text{REF}})) / (\text{Sens}_{\text{IDEAL}} \times I_{\text{PR}}) \times 100</math> AND TOTAL ERROR COMPONENTS</b>						
Total Error	$E_{\text{TOT}}$	$I_{\text{P}} = I_{\text{PR}(\text{max})}$	-1.75	-0.5 ± 0.6	1.75	%
Sensitivity Error	$E_{\text{SENS}}$	$I_{\text{P}} = I_{\text{PR}(\text{max})}$ , $T_A = 25^\circ\text{C}$ to $125^\circ\text{C}$ , $T_A = -40^\circ\text{C}$ to $25^\circ\text{C}$	-1	-0.3 ± 0.5	1	%
Zero Current Reference Error	$V_{\text{RE}}$	$V_{\text{REFactual}} - V_{\text{REFideal}}$ , $I_{\text{P}} = 0 \text{ A}$ , $T_A = 25^\circ\text{C}$ to $125^\circ\text{C}$	-10	-2 ± 3	10	mV
		$V_{\text{REFactual}} - V_{\text{REFideal}}$ , $I_{\text{P}} = 0 \text{ A}$ , $T_A = -40^\circ\text{C}$ to $25^\circ\text{C}$	-10	-1 ± 3	10	mV
Offset Error	$V_{\text{OE}}$	$V_{\text{IOUT(Q)}} - V_{\text{REF}}$ , $I_{\text{P}} = 0 \text{ A}$ , $T_A = 25^\circ\text{C}$ to $125^\circ\text{C}$	-8	±5	8	mV
		$V_{\text{IOUT(Q)}} - V_{\text{REF}}$ , $I_{\text{P}} = 0 \text{ A}$ , $T_A = -40^\circ\text{C}$ to $25^\circ\text{C}$	-8	-1 ± 3	8	mV
QVO Error	$V_{\text{QE}}$	$V_{\text{IOUT(Q)}}$ , $I_{\text{P}} = 0 \text{ A}$ , $T_A = 25^\circ\text{C}$ to $125^\circ\text{C}$	-10	-3 ± 4	10	mV
		$V_{\text{IOUT(Q)}}$ , $I_{\text{P}} = 0 \text{ A}$ , $T_A = -40^\circ\text{C}$ to $25^\circ\text{C}$	-10	±5	10	mV
<b>TOTAL ERROR AND TOTAL ERROR COMPONENTS INCLUDING LIFETIME DRIFT [2,3]</b>						
Total Error Including Lifetime Drift	$E_{\text{TOT\_LTD}}$	$I_{\text{P}} = I_{\text{PR}(\text{max})}$	-3.4	-1.4 ± 1.2	3.4	%
Sensitivity Error Including Lifetime Drift	$E_{\text{SENS\_LTD}}$	$I_{\text{P}} = I_{\text{PR}(\text{max})}$ , $T_A = 25^\circ\text{C}$ to $125^\circ\text{C}$ or $-40^\circ\text{C}$ to $25^\circ\text{C}$	-3.2	-1.3 ± 1.1	3.2	%
Zero Current Reference Error Including Lifetime Drift	$V_{\text{RE\_LTD}}$	$V_{\text{REFactual}} - V_{\text{REFideal}}$ , $I_{\text{P}} = 0 \text{ A}$ , $T_A = 25^\circ\text{C}$ to $125^\circ\text{C}$	-10	-3 ± 4	10	mV
		$V_{\text{REFactual}} - V_{\text{REFideal}}$ , $I_{\text{P}} = 0 \text{ A}$ , $T_A = -40^\circ\text{C}$ to $25^\circ\text{C}$	-10	-2 ± 3	10	mV
Offset Error Including Lifetime Drift	$V_{\text{OE\_LTD}}$	$V_{\text{IOUT(Q)}} - V_{\text{REF}}$ , $I_{\text{P}} = 0 \text{ A}$ , $T_A = 25^\circ\text{C}$ to $125^\circ\text{C}$	-10	-2 ± 5	10	mV
		$V_{\text{IOUT(Q)}} - V_{\text{REF}}$ , $I_{\text{P}} = 0 \text{ A}$ , $T_A = -40^\circ\text{C}$ to $25^\circ\text{C}$	-10	±4	10	mV
QVO Error Including Lifetime Drift	$V_{\text{QE\_LTD}}$	$V_{\text{IOUT(Q)}}$ , $I_{\text{P}} = 0 \text{ A}$ , $T_A = 25^\circ\text{C}$ to $125^\circ\text{C}$	-14	-4 ± 6	14	mV
		$V_{\text{IOUT(Q)}}$ , $I_{\text{P}} = 0 \text{ A}$ , $T_A = -40^\circ\text{C}$ to $25^\circ\text{C}$	-10	±7	10	mV

[1] Typical values are the mean ±3 sigma of production distributions. These are formatted as mean ±3 sigma.

[2] Typical values are the mean ±3 sigma statistical combination of production and AEC-Q100 individual drift distributions. These are formatted as mean ±3 sigma.

[3] Lifetime drift characteristics are based on a statistical combination of production distributions and worst case distribution of parametric drift of individuals observed during AEC-Q100 qualification.

## ACS37002KMABTR-050B3

### ACS37002KMABTR-050B3 Gain\_Sel Pin Performance Key

				Selection Identifier
Parameter (Units)	Gain_Sel_1 (Boolean)	Gain_Sel_0 (Boolean)	Sens (mV/A)	Max IP (A)
Type	Digital Input	Digital Input	Calculation	Bidirectional
Selection Combination	0	0	26.4	50
	0	1	33	40
	1	0	39.6	33.3
	1	1	19.8	66.7

**ACS37002KMABTR-050B3 PERFORMANCE CHARACTERISTICS:** Valid through full operating temperature range,  $T_A = -40^\circ\text{C}$  to  $125^\circ\text{C}$ ,  $C_{\text{BYPASS}} = 0.1 \mu\text{F}$ , and  $V_{\text{CC}} = 3.3 \text{ V}$ , unless otherwise specified

Characteristic	Symbol	Test Conditions	Min.	Typ. [1]	Max.	Units
<b>NOMINAL PERFORMANCE</b>						
Current Sensing Range	$I_{\text{PR}}$	Gain Sel 00	-50	-	50	A
		Gain Sel 01	-40	-	40	A
		Gain Sel 10	-33.3	-	33.3	A
		Gain Sel 11	-66.7	-	66.7	A
Sensitivity	Sens	Gain Sel 00; $I_{\text{PR}(\text{min})} < I_{\text{P}} < I_{\text{PR}(\text{max})}$	-	26.4	-	mV/A
		Gain Sel 01; $I_{\text{PR}(\text{min})} < I_{\text{P}} < I_{\text{PR}(\text{max})}$	-	33	-	mV/A
		Gain Sel 10; $I_{\text{PR}(\text{min})} < I_{\text{P}} < I_{\text{PR}(\text{max})}$	-	39.6	-	mV/A
		Gain Sel 11; $I_{\text{PR}(\text{min})} < I_{\text{P}} < I_{\text{PR}(\text{max})}$	-	19.8	-	mV/A
Overcurrent Fault Operating Range	$I_{\text{OCF-OR}}$	Typ. = factory-programmed default, FS = Full-Scale	50	100	200	%FS
Zero Current Output Voltage	$V_{\text{IOUT(Q)}}$	Bidirectional; $I_{\text{P}} = 0 \text{ A}$ , $T_A = 25^\circ\text{C}$	-	1.65	-	V
<b>TOTAL ERROR (<math>V_{\text{IOUT(ACTUAL)}} - (\text{Sens}_{(\text{IDEAL})} \times I_{\text{PR}} + V_{\text{REF}})</math>) / (<math>\text{Sens}_{(\text{IDEAL})} \times I_{\text{PR}})</math> × 100 AND TOTAL ERROR COMPONENTS</b>						
Total Error	$E_{\text{TOT}}$	$I_{\text{P}} = I_{\text{PR}(\text{max})}$	-1.75	-0.5 ±0.6	1.75	%
Sensitivity Error	$E_{\text{SENS}}$	$I_{\text{P}} = I_{\text{PR}(\text{max})}$ , $T_A = 25^\circ\text{C}$ to $125^\circ\text{C}$ , $T_A = -40^\circ\text{C}$ to $25^\circ\text{C}$	-1	-0.3 ±0.5	1	%
Zero Current Reference Error	$V_{\text{RE}}$	$V_{\text{REFactual}} - V_{\text{REFideal}}$ , $I_{\text{P}} = 0 \text{ A}$ , $T_A = 25^\circ\text{C}$ to $125^\circ\text{C}$	-10	-2 ±3	10	mV
		$V_{\text{REFactual}} - V_{\text{REFideal}}$ , $I_{\text{P}} = 0 \text{ A}$ , $T_A = -40^\circ\text{C}$ to $25^\circ\text{C}$	-10	-1 ±3	10	mV
Offset Error	$V_{\text{OE}}$	$V_{\text{IOUT(Q)}} - V_{\text{REF}}$ , $I_{\text{P}} = 0 \text{ A}$ , $T_A = 25^\circ\text{C}$ to $125^\circ\text{C}$	-8	±5	8	mV
		$V_{\text{IOUT(Q)}} - V_{\text{REF}}$ , $I_{\text{P}} = 0 \text{ A}$ , $T_A = -40^\circ\text{C}$ to $25^\circ\text{C}$	-8	-1 ±3	8	mV
QVO Error	$V_{\text{QE}}$	$V_{\text{IOUT(Q)}}$ , $I_{\text{P}} = 0 \text{ A}$ , $T_A = 25^\circ\text{C}$ to $125^\circ\text{C}$	-10	-3 ±4	10	mV
		$V_{\text{IOUT(Q)}}$ , $I_{\text{P}} = 0 \text{ A}$ , $T_A = -40^\circ\text{C}$ to $25^\circ\text{C}$	-10	±5	10	mV
<b>TOTAL ERROR AND TOTAL ERROR COMPONENTS INCLUDING LIFETIME DRIFT [2,3]</b>						
Total Error Including Lifetime Drift	$E_{\text{TOT\_LTD}}$	$I_{\text{P}} = I_{\text{PR}(\text{max})}$	-3.4	-1.4 ±1.2	3.4	%
Sensitivity Error Including Lifetime Drift	$E_{\text{SENS\_LTD}}$	$I_{\text{P}} = I_{\text{PR}(\text{max})}$ , $T_A = 25^\circ\text{C}$ to $125^\circ\text{C}$ or $-40^\circ\text{C}$ to $25^\circ\text{C}$	-3.2	-1.3 ±1.1	3.2	%
Zero Current Reference Error Including Lifetime Drift	$V_{\text{RE\_LTD}}$	$V_{\text{REFactual}} - V_{\text{REFideal}}$ , $I_{\text{P}} = 0 \text{ A}$ , $T_A = 25^\circ\text{C}$ to $125^\circ\text{C}$	-10	-3 ±4	10	mV
		$V_{\text{REFactual}} - V_{\text{REFideal}}$ , $I_{\text{P}} = 0 \text{ A}$ , $T_A = -40^\circ\text{C}$ to $25^\circ\text{C}$	-10	-2 ±3	10	mV
Offset Error Including Lifetime Drift	$V_{\text{OE\_LTD}}$	$V_{\text{IOUT(Q)}} - V_{\text{REF}}$ , $I_{\text{P}} = 0 \text{ A}$ , $T_A = 25^\circ\text{C}$ to $125^\circ\text{C}$	-10	-2 ±5	10	mV
		$V_{\text{IOUT(Q)}} - V_{\text{REF}}$ , $I_{\text{P}} = 0 \text{ A}$ , $T_A = -40^\circ\text{C}$ to $25^\circ\text{C}$	-10	±4	10	mV
QVO Error Including Lifetime Drift	$V_{\text{QE\_LTD}}$	$V_{\text{IOUT(Q)}}$ , $I_{\text{P}} = 0 \text{ A}$ , $T_A = 25^\circ\text{C}$ to $125^\circ\text{C}$	-14	-4 ±6	14	mV
		$V_{\text{IOUT(Q)}}$ , $I_{\text{P}} = 0 \text{ A}$ , $T_A = -40^\circ\text{C}$ to $25^\circ\text{C}$	-10	±7	10	mV

[1] Typical values are the mean ±3 sigma of production distributions. These are formatted as mean ±3 sigma.

[2] Typical values are the mean ±3 sigma statistical combination of production and AEC-Q100 individual drift distributions. These are formatted as mean ±3 sigma.

[3] Lifetime drift characteristics are based on a statistical combination of production distributions and worst case distribution of parametric drift of individuals observed during AEC-Q100 qualification.

## ACS37002LLAATR-015B5

### ACS37002LLAATR-015B5 Gain\_Sel Pin Performance Key

				Selection Identifier
Parameter (Units)	Gain_Sel_1 (Boolean)	Gain_Sel_0 (Boolean)	Sens (mV/A)	Max IP (A)
Type	Digital Input	Digital Input	Calculation	Bidirectional
Selection Combination	0	0	133.3	15
	0	1	166.6	12
	1	0	200	10
	1	1	100	20

**ACS37002LLAATR-015B5 PERFORMANCE CHARACTERISTICS:** Valid through full operating temperature range,  $T_A = -40^\circ\text{C}$  to  $150^\circ\text{C}$ ,  $C_{\text{BYPASS}} = 0.1 \mu\text{F}$ , and  $V_{\text{CC}} = 5 \text{V}$ , unless otherwise specified

Characteristic	Symbol	Test Conditions	Min.	Typ. [1]	Max.	Units
<b>NOMINAL PERFORMANCE</b>						
Current Sensing Range	$I_{\text{PR}}$	Gain Sel 00	-15	-	15	A
		Gain Sel 01	-12	-	12	A
		Gain Sel 10	-10	-	10	A
		Gain Sel 11	-20	-	20	A
Sensitivity	Sens	Gain Sel 00; $I_{\text{PR}(\text{min})} < I_{\text{P}} < I_{\text{PR}(\text{max})}$	-	133.3	-	mV/A
		Gain Sel 01; $I_{\text{PR}(\text{min})} < I_{\text{P}} < I_{\text{PR}(\text{max})}$	-	166.6	-	mV/A
		Gain Sel 10; $I_{\text{PR}(\text{min})} < I_{\text{P}} < I_{\text{PR}(\text{max})}$	-	200	-	mV/A
		Gain Sel 11; $I_{\text{PR}(\text{min})} < I_{\text{P}} < I_{\text{PR}(\text{max})}$	-	100	-	mV/A
Overcurrent Fault Operating Range	$I_{\text{OCF-OR}}$	Typ. = factory-programmed default, FS = Full-Scale	50	100	200	%FS
Zero Current Output Voltage	$V_{\text{IOUT(Q)}}$	Bidirectional; $I_{\text{P}} = 0 \text{A}$ , $T_A = 25^\circ\text{C}$	-	2.5	-	V
<b>TOTAL ERROR (<math>V_{\text{IOUT(ACTUAL)}} - (\text{Sens}_{(\text{IDEAL})} \times I_{\text{PR}} + V_{\text{REF}})</math>) / (<math>\text{Sens}_{(\text{IDEAL})} \times I_{\text{PR}} \times 100</math>) AND TOTAL ERROR COMPONENTS</b>						
Total Error	$E_{\text{TOT}}$	$I_{\text{P}} = I_{\text{PR}(\text{max})}$ , $T_A = 25^\circ\text{C}$ to $150^\circ\text{C}$	-1.75	$\pm 1.2$	1.75	%
		$I_{\text{P}} = I_{\text{PR}(\text{max})}$ , $T_A = -40^\circ\text{C}$ to $25^\circ\text{C}$	-1.75	$\pm 1.4$	1.75	%
Sensitivity Error	$E_{\text{SENS}}$	$I_{\text{P}} = I_{\text{PR}(\text{max})}$ , $T_A = 25^\circ\text{C}$ to $150^\circ\text{C}$ , $T_A = -40^\circ\text{C}$ to $25^\circ\text{C}$	-1.5	$\pm 1.2$	1.5	%
Zero Current Reference Error	$V_{\text{RE}}$	$V_{\text{REFactual}} - V_{\text{REFideal}}$ , $I_{\text{P}} = 0 \text{A}$ , $T_A = 25^\circ\text{C}$ to $150^\circ\text{C}$ , $T_A = -40^\circ\text{C}$ to $25^\circ\text{C}$	-10	$\pm 3$	10	mV
Offset Error	$V_{\text{OE}}$	$V_{\text{IOUT(Q)}} - V_{\text{REF}}$ , $I_{\text{P}} = 0 \text{A}$ , $T_A = 25^\circ\text{C}$ to $150^\circ\text{C}$ , $T_A = -40^\circ\text{C}$ to $25^\circ\text{C}$	-8	$\pm 5$	8	mV
QVO Error	$V_{\text{QE}}$	$V_{\text{IOUT(Q)}}$ , $I_{\text{P}} = 0 \text{A}$ , $T_A = 25^\circ\text{C}$ to $150^\circ\text{C}$ , $T_A = -40^\circ\text{C}$ to $25^\circ\text{C}$	-10	$\pm 5$	10	mV
<b>TOTAL ERROR AND TOTAL ERROR COMPONENTS INCLUDING LIFETIME DRIFT [2][3]</b>						
Total Error Including Lifetime Drift	$E_{\text{TOT\_LTD}}$	$I_{\text{P}} = I_{\text{PR}(\text{max})}$ , $T_A = 25^\circ\text{C}$ to $150^\circ\text{C}$	-3.7	$-0.7 \pm 1.8$	3.7	%
		$I_{\text{P}} = I_{\text{PR}(\text{max})}$ , $T_A = -40^\circ\text{C}$ to $25^\circ\text{C}$	-3.5	$-0.5 \pm 1.9$	3.5	%
Sensitivity Error Including Lifetime Drift	$E_{\text{SENS\_LTD}}$	$I_{\text{P}} = I_{\text{PR}(\text{max})}$ , $T_A = 25^\circ\text{C}$ to $150^\circ\text{C}$	-3.5	$-0.8 \pm 1.6$	3.5	%
		$I_{\text{P}} = I_{\text{PR}(\text{max})}$ , $T_A = -40^\circ\text{C}$ to $25^\circ\text{C}$	-3.4	$-0.5 \pm 1.8$	3.4	%
Zero Current Reference Error Including Lifetime Drift	$V_{\text{RE\_LTD}}$	$V_{\text{REFactual}} - V_{\text{REFideal}}$ , $I_{\text{P}} = 0 \text{A}$ , $T_A = 25^\circ\text{C}$ to $125^\circ\text{C}$ , $T_A = -40^\circ\text{C}$ to $25^\circ\text{C}$	-11	$\pm 7$	11	mV
Offset Error Including Lifetime Drift	$V_{\text{OE\_LTD}}$	$V_{\text{IOUT(Q)}} - V_{\text{REF}}$ , $I_{\text{P}} = 0 \text{A}$ , $T_A = 25^\circ\text{C}$ to $125^\circ\text{C}$	-15	$2 \pm 7$	15	mV
		$V_{\text{IOUT(Q)}} - V_{\text{REF}}$ , $I_{\text{P}} = 0 \text{A}$ , $T_A = -40^\circ\text{C}$ to $25^\circ\text{C}$	-11	$\pm 7$	11	mV
QVO Error Including Lifetime Drift	$V_{\text{QE\_LTD}}$	$V_{\text{IOUT(Q)}}$ , $I_{\text{P}} = 0 \text{A}$ , $T_A = 25^\circ\text{C}$ to $125^\circ\text{C}$	-17	$\pm 9$	17	mV
		$V_{\text{IOUT(Q)}}$ , $I_{\text{P}} = 0 \text{A}$ , $T_A = -40^\circ\text{C}$ to $25^\circ\text{C}$	-14	$\pm 8$	14	mV

[1] Typical values are the mean  $\pm 3$  sigma of production distributions. These are formatted as mean  $\pm 3$  sigma.

[2] Typical values are the mean  $\pm 3$  sigma statistical combination of production and AEC-Q100 individual drift distributions. These are formatted as mean  $\pm 3$  sigma.

[3] Lifetime drift characteristics are based on a statistical combination of production distributions and worst case distribution of parametric drift of individuals observed during AEC-Q100 qualification.

### ACS37002LLAATR-025B5

#### ACS37002LLAATR-025B5 Gain\_Sel Pin Performance Key

				Selection Identifier
Parameter (Units)	Gain_Sel_1 (Boolean)	Gain_Sel_0 (Boolean)	Sens (mV/A)	Max IP (A)
Type	Digital Input	Digital Input	Calculation	Bidirectional
Selection Combination	0	0	80	25
	0	1	66.6	30
	1	0	53.3	37.5
	1	1	40	50

**ACS37002LLAATR-025B5 PERFORMANCE CHARACTERISTICS:** Valid through full operating temperature range,  $T_A = -40^\circ\text{C}$  to  $150^\circ\text{C}$ ,  $C_{\text{BYPASS}} = 0.1 \mu\text{F}$ , and  $V_{\text{CC}} = 5 \text{ V}$ , unless otherwise specified

Characteristic	Symbol	Test Conditions	Min.	Typ. [1]	Max.	Units
<b>NOMINAL PERFORMANCE</b>						
Current Sensing Range	$I_{\text{PR}}$	Gain Sel 00	-25	-	25	A
		Gain Sel 01	-30	-	30	A
		Gain Sel 10	-37.5	-	37.5	A
		Gain Sel 11	-50	-	50	A
Sensitivity	Sens	Gain Sel 00; $I_{\text{PR}(\text{min})} < I_{\text{P}} < I_{\text{PR}(\text{max})}$	-	80	-	mV/A
		Gain Sel 01; $I_{\text{PR}(\text{min})} < I_{\text{P}} < I_{\text{PR}(\text{max})}$	-	66.6	-	mV/A
		Gain Sel 10; $I_{\text{PR}(\text{min})} < I_{\text{P}} < I_{\text{PR}(\text{max})}$	-	53.3	-	mV/A
		Gain Sel 11; $I_{\text{PR}(\text{min})} < I_{\text{P}} < I_{\text{PR}(\text{max})}$	-	40	-	mV/A
Overcurrent Fault Operating Range	$I_{\text{OCF-OR}}$	Typ. = factory-programmed default, FS = Full-Scale	50	100	200	%FS
Zero Current Output Voltage	$V_{\text{IOUT(Q)}}$	Bidirectional; $I_{\text{P}} = 0 \text{ A}$ , $T_A = 25^\circ\text{C}$	-	2.5	-	V
<b>TOTAL ERROR (<math>V_{\text{IOUT(ACTUAL)}} - (\text{Sens}_{\text{IDEAL}} \times I_{\text{PR}} + V_{\text{REF}})) / (\text{Sens}_{\text{IDEAL}} \times I_{\text{PR}}) \times 100</math> AND TOTAL ERROR COMPONENTS</b>						
Total Error	$E_{\text{TOT}}$	$I_{\text{P}} = I_{\text{PR}(\text{max})}$ , $T_A = 25^\circ\text{C}$ to $150^\circ\text{C}$	-1.75	$\pm 1.2$	1.75	%
		$I_{\text{P}} = I_{\text{PR}(\text{max})}$ , $T_A = -40^\circ\text{C}$ to $25^\circ\text{C}$	-1.75	$\pm 1.4$	1.75	%
Sensitivity Error	$E_{\text{SENS}}$	$I_{\text{P}} = I_{\text{PR}(\text{max})}$ , $T_A = 25^\circ\text{C}$ to $150^\circ\text{C}$ , $T_A = -40^\circ\text{C}$ to $25^\circ\text{C}$	-1.5	$\pm 1.2$	1.5	%
Zero Current Reference Error	$V_{\text{RE}}$	$V_{\text{REFactual}} - V_{\text{REFideal}}$ , $I_{\text{P}} = 0 \text{ A}$ , $T_A = 25^\circ\text{C}$ to $150^\circ\text{C}$ , $T_A = -40^\circ\text{C}$ to $25^\circ\text{C}$	-10	$\pm 3$	10	mV
Offset Error	$V_{\text{OE}}$	$V_{\text{IOUT(Q)}} - V_{\text{REF}}$ , $I_{\text{P}} = 0 \text{ A}$ , $T_A = 25^\circ\text{C}$ to $150^\circ\text{C}$ , $T_A = -40^\circ\text{C}$ to $25^\circ\text{C}$	-8	$\pm 5$	8	mV
QVO Error	$V_{\text{QE}}$	$V_{\text{IOUT(Q)}}$ , $I_{\text{P}} = 0 \text{ A}$ , $T_A = 25^\circ\text{C}$ to $150^\circ\text{C}$ , $T_A = -40^\circ\text{C}$ to $25^\circ\text{C}$	-10	$\pm 5$	10	mV
<b>TOTAL ERROR AND TOTAL ERROR COMPONENTS INCLUDING LIFETIME DRIFT [2][3]</b>						
Total Error Including Lifetime Drift	$E_{\text{TOT\_LTD}}$	$I_{\text{P}} = I_{\text{PR}(\text{max})}$ , $T_A = 25^\circ\text{C}$ to $150^\circ\text{C}$	-3.7	$-0.7 \pm 1.8$	3.7	%
		$I_{\text{P}} = I_{\text{PR}(\text{max})}$ , $T_A = -40^\circ\text{C}$ to $25^\circ\text{C}$	-3.5	$-0.5 \pm 1.9$	3.5	%
Sensitivity Error Including Lifetime Drift	$E_{\text{SENS\_LTD}}$	$I_{\text{P}} = I_{\text{PR}(\text{max})}$ , $T_A = 25^\circ\text{C}$ to $150^\circ\text{C}$	-3.5	$-0.8 \pm 1.6$	3.5	%
		$I_{\text{P}} = I_{\text{PR}(\text{max})}$ , $T_A = -40^\circ\text{C}$ to $25^\circ\text{C}$	-3.4	$-0.5 \pm 1.8$	3.4	%
Zero Current Reference Error Including Lifetime Drift	$V_{\text{RE\_LTD}}$	$V_{\text{REFactual}} - V_{\text{REFideal}}$ , $I_{\text{P}} = 0 \text{ A}$ , $T_A = 25^\circ\text{C}$ to $125^\circ\text{C}$ , $T_A = -40^\circ\text{C}$ to $25^\circ\text{C}$	-11	$\pm 7$	11	mV
Offset Error Including Lifetime Drift	$V_{\text{OE\_LTD}}$	$V_{\text{IOUT(Q)}} - V_{\text{REF}}$ , $I_{\text{P}} = 0 \text{ A}$ , $T_A = 25^\circ\text{C}$ to $125^\circ\text{C}$	-15	$2 \pm 7$	15	mV
		$V_{\text{IOUT(Q)}} - V_{\text{REF}}$ , $I_{\text{P}} = 0 \text{ A}$ , $T_A = -40^\circ\text{C}$ to $25^\circ\text{C}$	-11	$\pm 7$	11	mV
QVO Error Including Lifetime Drift	$V_{\text{QE\_LTD}}$	$V_{\text{IOUT(Q)}}$ , $I_{\text{P}} = 0 \text{ A}$ , $T_A = 25^\circ\text{C}$ to $125^\circ\text{C}$	-17	$\pm 9$	17	mV
		$V_{\text{IOUT(Q)}}$ , $I_{\text{P}} = 0 \text{ A}$ , $T_A = -40^\circ\text{C}$ to $25^\circ\text{C}$	-14	$\pm 8$	14	mV

[1] Typical values are the mean  $\pm 3$  sigma of production distributions. These are formatted as mean  $\pm 3$  sigma.

[2] Typical values are the mean  $\pm 3$  sigma statistical combination of production and AEC-Q100 individual drift distributions. These are formatted as mean  $\pm 3$  sigma.

[3] Lifetime drift characteristics are based on a statistical combination of production distributions and worst case distribution of parametric drift of individuals observed during AEC-Q100 qualification.

### ACS37002LLAATR-015B3

#### ACS37002LLAATR-015B3 Gain\_Sel Pin Performance Key

				Selection Identifier
Parameter (Units)	Gain_Sel_1 (Boolean)	Gain_Sel_0 (Boolean)	Sens (mV/A)	Max IP (A)
Type	Digital Input	Digital Input	Calculation	Bidirectional
Selection Combination	0	0	88	15
	0	1	110	12
	1	0	132	10
	1	1	66	20

**ACS37002LLAATR-015B3 PERFORMANCE CHARACTERISTICS:** Valid through full operating temperature range,  $T_A = -40^\circ\text{C}$  to  $150^\circ\text{C}$ ,  $C_{\text{BYPASS}} = 0.1 \mu\text{F}$ , and  $V_{\text{CC}} = 3.3 \text{ V}$ , unless otherwise specified

Characteristic	Symbol	Test Conditions	Min.	Typ. [1]	Max.	Units
<b>NOMINAL PERFORMANCE</b>						
Current Sensing Range	$I_{\text{PR}}$	Gain Sel 00	-15	-	15	A
		Gain Sel 01	-12	-	12	A
		Gain Sel 10	-10	-	10	A
		Gain Sel 11	-20	-	20	A
Sensitivity	Sens	Gain Sel 00; $I_{\text{PR}(\text{min})} < I_{\text{P}} < I_{\text{PR}(\text{max})}$	-	88	-	mV/A
		Gain Sel 01; $I_{\text{PR}(\text{min})} < I_{\text{P}} < I_{\text{PR}(\text{max})}$	-	110	-	mV/A
		Gain Sel 10; $I_{\text{PR}(\text{min})} < I_{\text{P}} < I_{\text{PR}(\text{max})}$	-	132	-	mV/A
		Gain Sel 11; $I_{\text{PR}(\text{min})} < I_{\text{P}} < I_{\text{PR}(\text{max})}$	-	66	-	mV/A
Overcurrent Fault Operating Range	$I_{\text{OCF-OR}}$	Typ. = factory-programmed default, FS = Full-Scale	50	100	200	%FS
Zero Current Output Voltage	$V_{\text{IOUT(Q)}}$	Bidirectional; $I_{\text{P}} = 0 \text{ A}$ , $T_A = 25^\circ\text{C}$	-	1.65	-	V
<b>TOTAL ERROR (<math>V_{\text{IOUT(ACTUAL)}} - (\text{Sens}_{\text{IDEAL}} \times I_{\text{PR}} + V_{\text{REF}})</math>) / (<math>\text{Sens}_{\text{IDEAL}} \times I_{\text{PR}} \times 100</math>) AND TOTAL ERROR COMPONENTS</b>						
Total Error	$E_{\text{TOT}}$	$I_{\text{P}} = I_{\text{PR}(\text{max})}$ , $T_A = 25^\circ\text{C}$ to $150^\circ\text{C}$	-1.75	$\pm 1.2$	1.75	%
		$I_{\text{P}} = I_{\text{PR}(\text{max})}$ , $T_A = -40^\circ\text{C}$ to $25^\circ\text{C}$	-1.75	$\pm 1.4$	1.75	%
Sensitivity Error	$E_{\text{SENS}}$	$I_{\text{P}} = I_{\text{PR}(\text{max})}$ , $T_A = 25^\circ\text{C}$ to $150^\circ\text{C}$ , $T_A = -40^\circ\text{C}$ to $25^\circ\text{C}$	-1.5	$\pm 1.2$	1.5	%
Zero Current Reference Error	$V_{\text{RE}}$	$V_{\text{REFactual}} - V_{\text{REFideal}}$ , $I_{\text{P}} = 0 \text{ A}$ , $T_A = 25^\circ\text{C}$ to $150^\circ\text{C}$ , $T_A = -40^\circ\text{C}$ to $25^\circ\text{C}$	-10	$\pm 3$	10	mV
Offset Error	$V_{\text{OE}}$	$V_{\text{IOUT(Q)}} - V_{\text{REF}}$ , $I_{\text{P}} = 0 \text{ A}$ , $T_A = 25^\circ\text{C}$ to $150^\circ\text{C}$ , $T_A = -40^\circ\text{C}$ to $25^\circ\text{C}$	-8	$\pm 5$	8	mV
QVO Error	$V_{\text{QE}}$	$V_{\text{IOUT(Q)}}$ , $I_{\text{P}} = 0 \text{ A}$ , $T_A = 25^\circ\text{C}$ to $150^\circ\text{C}$ , $T_A = -40^\circ\text{C}$ to $25^\circ\text{C}$	-10	$\pm 5$	10	mV
<b>TOTAL ERROR AND TOTAL ERROR COMPONENTS INCLUDING LIFETIME DRIFT [2][3]</b>						
Total Error Including Lifetime Drift	$E_{\text{TOT\_LTD}}$	$I_{\text{P}} = I_{\text{PR}(\text{max})}$ , $T_A = 25^\circ\text{C}$ to $150^\circ\text{C}$	-3.7	$-0.7 \pm 1.8$	3.7	%
		$I_{\text{P}} = I_{\text{PR}(\text{max})}$ , $T_A = -40^\circ\text{C}$ to $25^\circ\text{C}$	-3.5	$-0.5 \pm 1.9$	3.5	%
Sensitivity Error Including Lifetime Drift	$E_{\text{SENS\_LTD}}$	$I_{\text{P}} = I_{\text{PR}(\text{max})}$ , $T_A = 25^\circ\text{C}$ to $150^\circ\text{C}$	-3.5	$-0.8 \pm 1.6$	3.5	%
		$I_{\text{P}} = I_{\text{PR}(\text{max})}$ , $T_A = -40^\circ\text{C}$ to $25^\circ\text{C}$	-3.4	$-0.5 \pm 1.8$	3.4	%
Zero Current Reference Error Including Lifetime Drift	$V_{\text{RE\_LTD}}$	$V_{\text{REFactual}} - V_{\text{REFideal}}$ , $I_{\text{P}} = 0 \text{ A}$ , $T_A = 25^\circ\text{C}$ to $125^\circ\text{C}$ , $T_A = -40^\circ\text{C}$ to $25^\circ\text{C}$	-11	$\pm 7$	11	mV
Offset Error Including Lifetime Drift	$V_{\text{OE\_LTD}}$	$V_{\text{IOUT(Q)}} - V_{\text{REF}}$ , $I_{\text{P}} = 0 \text{ A}$ , $T_A = 25^\circ\text{C}$ to $125^\circ\text{C}$	-15	$2 \pm 7$	15	mV
		$V_{\text{IOUT(Q)}} - V_{\text{REF}}$ , $I_{\text{P}} = 0 \text{ A}$ , $T_A = -40^\circ\text{C}$ to $25^\circ\text{C}$	-11	$\pm 7$	11	mV
QVO Error Including Lifetime Drift	$V_{\text{QE\_LTD}}$	$V_{\text{IOUT(Q)}}$ , $I_{\text{P}} = 0 \text{ A}$ , $T_A = 25^\circ\text{C}$ to $125^\circ\text{C}$	-17	$\pm 9$	17	mV
		$V_{\text{IOUT(Q)}}$ , $I_{\text{P}} = 0 \text{ A}$ , $T_A = -40^\circ\text{C}$ to $25^\circ\text{C}$	-14	$\pm 8$	14	mV

[1] Typical values are the mean  $\pm 3$  sigma of production distributions. These are formatted as mean  $\pm 3$  sigma.

[2] Typical values are the mean  $\pm 3$  sigma statistical combination of production and AEC-Q100 individual drift distributions. These are formatted as mean  $\pm 3$  sigma.

[3] Lifetime drift characteristics are based on a statistical combination of production distributions and worst case distribution of parametric drift of individuals observed during AEC-Q100 qualification.



## ACS37002LLAATR-025U3

### ACS37002LLAATR-025U3 Gain\_Sel Pin Performance Key

				Selection Identifier
Parameter (Units)	Gain_Sel_1 (Boolean)	Gain_Sel_0 (Boolean)	Sens (mV/A)	Max IP (A)
Type	Digital Input	Digital Input	Calculation	Unidirectional
Selection Combination	0	0	105.6	25
	0	1	88	30
	1	0	70.4	37.5
	1	1	52.8	50

**ACS37002LLAATR-025U3 PERFORMANCE CHARACTERISTICS:** Valid through full operating temperature range,  $T_A = -40^\circ\text{C}$  to  $150^\circ\text{C}$ ,  $C_{\text{BYPASS}} = 0.1 \mu\text{F}$ , and  $V_{\text{CC}} = 3.3 \text{ V}$ , unless otherwise specified

Characteristic	Symbol	Test Conditions	Min.	Typ. [1]	Max.	Units
<b>NOMINAL PERFORMANCE</b>						
Current Sensing Range	$I_{\text{PR}}$	Gain Sel 00	0	–	25	A
		Gain Sel 01	0	–	30	A
		Gain Sel 10	0	–	37.5	A
		Gain Sel 11	0	–	50	A
Sensitivity	Sens	Gain Sel 00; $I_{\text{PR}(\text{min})} < I_{\text{P}} < I_{\text{PR}(\text{max})}$	–	105.6	–	mV/A
		Gain Sel 01; $I_{\text{PR}(\text{min})} < I_{\text{P}} < I_{\text{PR}(\text{max})}$	–	88	–	mV/A
		Gain Sel 10; $I_{\text{PR}(\text{min})} < I_{\text{P}} < I_{\text{PR}(\text{max})}$	–	70.4	–	mV/A
		Gain Sel 11; $I_{\text{PR}(\text{min})} < I_{\text{P}} < I_{\text{PR}(\text{max})}$	–	52.8	–	mV/A
Overcurrent Fault Operating Range	$I_{\text{OCF-OR}}$	Typ. = factory-programmed default, FS = Full-Scale	25	50	100	%FS
Zero Current Output Voltage	$V_{\text{IOUT(Q)}}$	Unidirectional; $I_{\text{P}} = 0 \text{ A}$ , $T_A = 25^\circ\text{C}$	–	0.33	–	V
<b>TOTAL ERROR (<math>V_{\text{IOUT(ACTUAL)}} - (\text{Sens}_{(\text{IDEAL})} \times I_{\text{PR}} + V_{\text{REF}})</math>) / (<math>\text{Sens}_{(\text{IDEAL})} \times I_{\text{PR}}) \times 100</math> AND TOTAL ERROR COMPONENTS</b>						
Total Error	$E_{\text{TOT}}$	$I_{\text{P}} = I_{\text{PR}(\text{max})}$ , $T_A = 25^\circ\text{C}$ to $150^\circ\text{C}$	–1.75	$\pm 1.2$	1.75	%
		$I_{\text{P}} = I_{\text{PR}(\text{max})}$ , $T_A = -40^\circ\text{C}$ to $25^\circ\text{C}$	–1.75	$\pm 1.4$	1.75	%
Sensitivity Error	$E_{\text{SENS}}$	$I_{\text{P}} = I_{\text{PR}(\text{max})}$ , $T_A = 25^\circ\text{C}$ to $150^\circ\text{C}$ , $T_A = -40^\circ\text{C}$ to $25^\circ\text{C}$	–1.5	$\pm 1.2$	1.5	%
Zero Current Reference Error	$V_{\text{RE}}$	$V_{\text{REFactual}} - V_{\text{REFideal}}$ , $I_{\text{P}} = 0 \text{ A}$ , $T_A = 25^\circ\text{C}$ to $150^\circ\text{C}$ , $T_A = -40^\circ\text{C}$ to $25^\circ\text{C}$	–10	$\pm 3$	10	mV
Offset Error	$V_{\text{OE}}$	$V_{\text{IOUT(Q)}} - V_{\text{REF}}$ , $I_{\text{P}} = 0 \text{ A}$ , $T_A = 25^\circ\text{C}$ to $150^\circ\text{C}$ , $T_A = -40^\circ\text{C}$ to $25^\circ\text{C}$	–8	$\pm 5$	8	mV
QVO Error	$V_{\text{QE}}$	$V_{\text{IOUT(Q)}}$ , $I_{\text{P}} = 0 \text{ A}$ , $T_A = 25^\circ\text{C}$ to $150^\circ\text{C}$ , $T_A = -40^\circ\text{C}$ to $25^\circ\text{C}$	–10	$\pm 5$	10	mV
<b>TOTAL ERROR AND TOTAL ERROR COMPONENTS INCLUDING LIFETIME DRIFT [2][3]</b>						
Total Error Including Lifetime Drift	$E_{\text{TOT\_LTD}}$	$I_{\text{P}} = I_{\text{PR}(\text{max})}$ , $T_A = 25^\circ\text{C}$ to $150^\circ\text{C}$	–3.7	$-0.7 \pm 1.8$	3.7	%
		$I_{\text{P}} = I_{\text{PR}(\text{max})}$ , $T_A = -40^\circ\text{C}$ to $25^\circ\text{C}$	–3.5	$-0.5 \pm 1.9$	3.5	%
Sensitivity Error Including Lifetime Drift	$E_{\text{SENS\_LTD}}$	$I_{\text{P}} = I_{\text{PR}(\text{max})}$ , $T_A = 25^\circ\text{C}$ to $150^\circ\text{C}$	–3.5	$-0.8 \pm 1.6$	3.5	%
		$I_{\text{P}} = I_{\text{PR}(\text{max})}$ , $T_A = -40^\circ\text{C}$ to $25^\circ\text{C}$	–3.4	$-0.5 \pm 1.8$	3.4	%
Zero Current Reference Error Including Lifetime Drift	$V_{\text{RE\_LTD}}$	$V_{\text{REFactual}} - V_{\text{REFideal}}$ , $I_{\text{P}} = 0 \text{ A}$ , $T_A = 25^\circ\text{C}$ to $125^\circ\text{C}$ , $T_A = -40^\circ\text{C}$ to $25^\circ\text{C}$	–11	$\pm 7$	11	mV
Offset Error Including Lifetime Drift	$V_{\text{OE\_LTD}}$	$V_{\text{IOUT(Q)}} - V_{\text{REF}}$ , $I_{\text{P}} = 0 \text{ A}$ , $T_A = 25^\circ\text{C}$ to $125^\circ\text{C}$	–15	$2 \pm 7$	15	mV
		$V_{\text{IOUT(Q)}} - V_{\text{REF}}$ , $I_{\text{P}} = 0 \text{ A}$ , $T_A = -40^\circ\text{C}$ to $25^\circ\text{C}$	–11	$\pm 7$	11	mV
QVO Error Including Lifetime Drift	$V_{\text{QE\_LTD}}$	$V_{\text{IOUT(Q)}}$ , $I_{\text{P}} = 0 \text{ A}$ , $T_A = 25^\circ\text{C}$ to $125^\circ\text{C}$	–17	$\pm 9$	17	mV
		$V_{\text{IOUT(Q)}}$ , $I_{\text{P}} = 0 \text{ A}$ , $T_A = -40^\circ\text{C}$ to $25^\circ\text{C}$	–14	$\pm 8$	14	mV

[1] Typical values are the mean  $\pm 3$  sigma of production distributions. These are formatted as mean  $\pm 3$  sigma.

[2] Typical values are the mean  $\pm 3$  sigma statistical combination of production and AEC-Q100 individual drift distributions. These are formatted as mean  $\pm 3$  sigma.

[3] Lifetime drift characteristics are based on a statistical combination of production distributions and worst case distribution of parametric drift of individuals observed during AEC-Q100 qualification.



### FUNCTIONAL DESCRIPTION

#### Power-On Reset Operation

The descriptions in this section assume: temperature = 25°C, with the labeled test conditions. The provided graphs in this section show  $V_{IOUT}$  moving with  $V_{CC}$ . The voltage of  $V_{IOUT}$  during a high-impedance state will be most consistent with a known load ( $R_L, C_L$ ).

#### POWER-ON/POWER-OFF

As  $V_{CC}$  ramps up, the  $V_{IOUT}$  and  $V_{REF}$  outputs are high impedance until  $V_{CC}$  reaches and passes  $V_{POR(H)}$  [1] in Figure 4.  $V_{REF}$  and  $V_{IOUT}$  will continue to report until  $V_{CC}$  is less than  $V_{POR(L)}$  [5] in Figure 4, at which point they will go high impedance. Note that the time it takes the output to reach a steady state will depend on the external circuitry used.

#### POWER-ON DELAY ( $t_{POD}$ )

When the supply is ramped to  $V_{POR(H)}$  [2] in Figure 4, the device will require a finite time to power its internal components before the outputs are released from high impedance and can respond to an input magnetic field. Power-On Time,  $t_{POD}$ , is defined as the time it takes for the output voltage to settle within  $\pm 10\%$  of its steady-state value under an applied magnetic field, which can be seen as the time from [1] to [A] in Figure 5. After this delay, the output will quickly approach  $V_{IOUT(IP)} = Sens \times IP + V_{REF}$ .

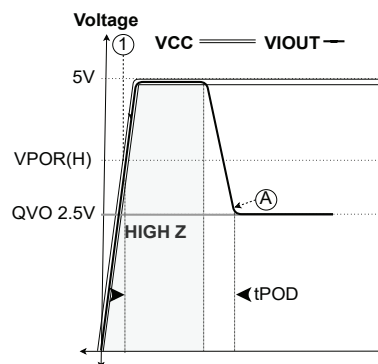

Figure 5:  $t_{POD}$ ,  $R_L =$  Pull-Up

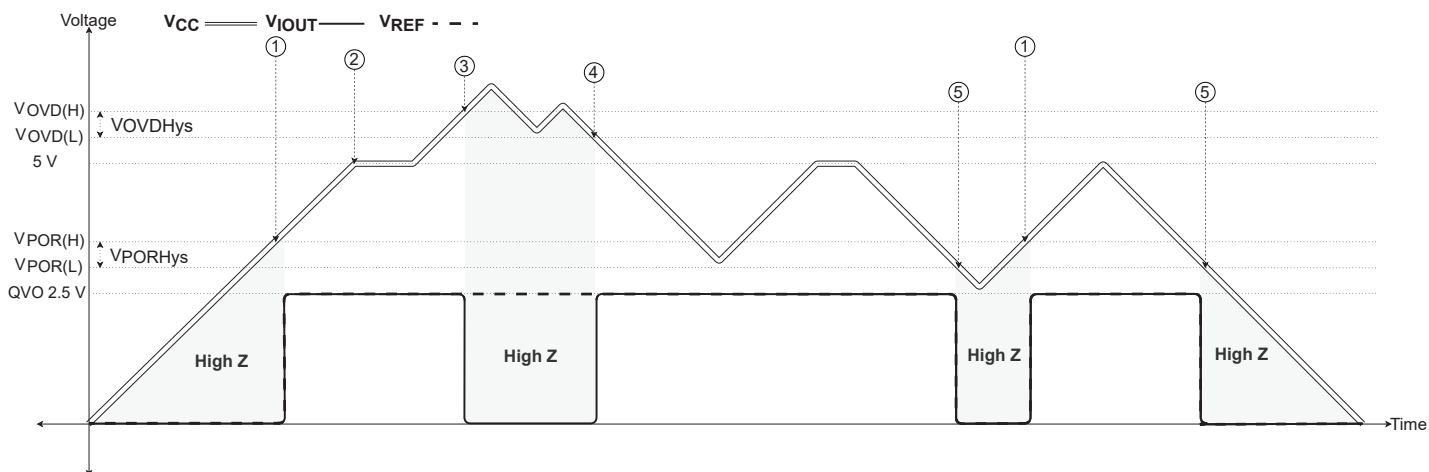

Figure 4: Power States Thresholds with  $V_{IOUT}$  Behavior for a 5 V Device,  $R_L =$  Pull-Down

### Overvoltage Detection (OVD)

To ensure that the device output is reporting accurately, the device contains an overvoltage detection flag. This flag on  $V_{IOUT}$  can be used to alert the system that the supply voltage is outside of the operational limits. When  $V_{CC}$  raises above  $V_{OVD(H)}$  [3] in Figure 6,  $V_{IOUT}$  will go high impedance and be pulled by the load resistor to  $V_{CC}$  or GND.  $V_{REF}$  continues to output normally.

There is hysteresis between OVD enable and disable thresholds to reducing nuisance flagging and clears.

The enable time for OVD,  $t_{OVD(E)}$ , is the time from  $V_{OVD(H)}$  [4] to OVD flag [B] in Figure 6. The enable flag for OVD has a counter to reduce transients faster than  $64 \mu s$  from triggering nuisance flags.

The disable time for OVD,  $t_{OVD(D)}$ , is the time from  $V_{OVD(L)}$  [5] until the device returns to normal operation [C] in Figure 6. The OVD disable time does not have a counter.

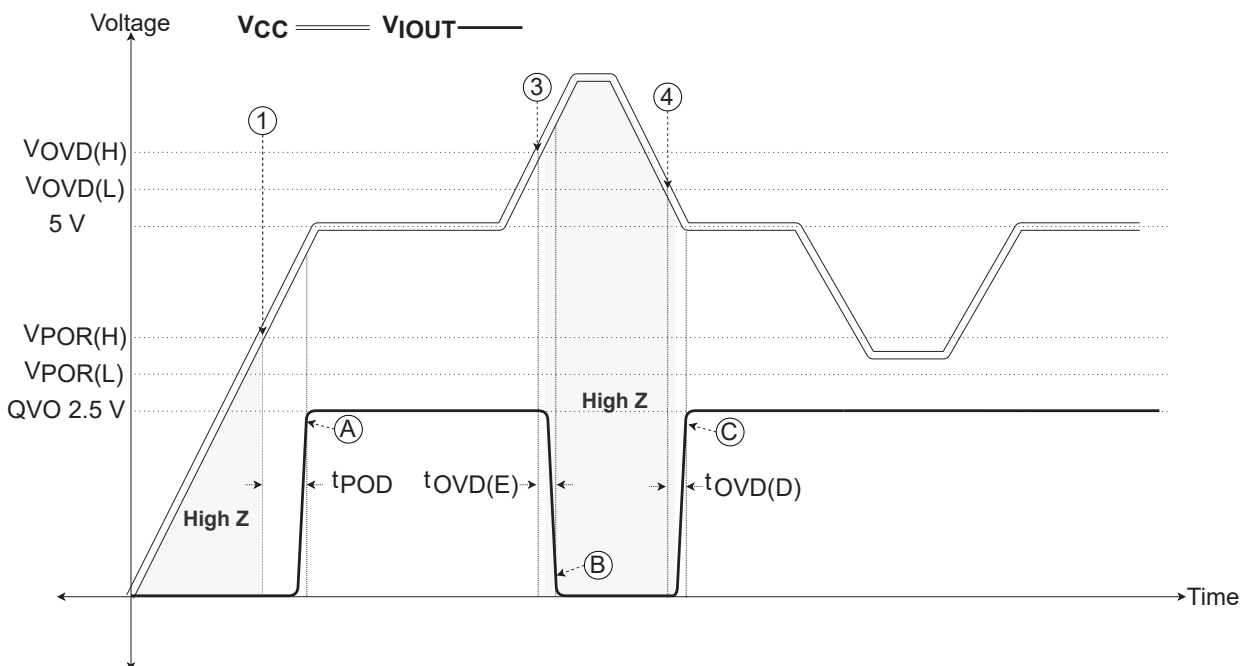

Figure 6:  $t_{POD}$  and  $t_{OVD(E/D)}$  with  $R_L = \text{Pull-Up}$

### Absolute Maximum Ratings

These are the maximum application or environmental conditions that the device can be subjected before damage may occur.

### SUPPLY ZENER CLAMP VOLTAGES

If the voltage applied to the device continues to increase past overvoltage detection, there is a point when the Zener diodes will turn on. These internal diodes are in place to protect the device from short high voltage or ESD events and should not be used as a feature to reduce the voltage on a line. Continued exposure to voltages higher than normal operating voltage,  $V_{CC}$ , can weaken or damage the Zener diodes, which will potentially damage the part.

### FORWARD AND REVERSE SUPPLY VOLTAGE

These are the largest voltage magnitudes that can be supplied to  $V_{CC}$  from GND during programming or transient switching. This voltage should not be used as a DC voltage bias for an extended time.

### FORWARD AND REVERSE OUTPUT VOLTAGE

The Forward Output Voltage or  $V_{FIOUT}$  voltage can be no greater than  $V_{CC} + 0.5$  up to 6.5 V. This is the greatest voltage that the output can be biased with from GND during programming or transient switching. The Reverse Output Voltage or  $V_{RIOUT}$  should not drop below  $-0.5$  V during programming or transient switching. These voltages should not be used as a DC voltage bias for an extended time.

### FORWARD AND REVERSE REFERENCE/FAULT VOLTAGE

The Forward Reference/Fault Voltage or  $V_{F-RF}$  voltage can be no greater than  $V_{CC} + 0.5$  up to 6.5 V. This is the greatest voltage that the  $V_{REF}$  and  $V_{OCF}$  can be biased with from GND during programming or transient switching. The Reverse Output Voltage or  $V_{R-RF}$  should not drop below  $-0.5$  V during programming or transient switching. These voltages should not be used as a DC voltage bias for an extended time.

### OUTPUT SOURCE AND SINK CURRENT

This is the maximum current that  $V_{IOUT}$  can passively sink or source before damage may occur.

### AMBIENT TEMPERATURE ( $T_A$ )

This is the ambient temperature of the device. The Operating Ambient Temperature Range is the ambient temperature range that the Common Electricals and Common Performance Characteristics limits are valid. The Optimized Ambient Temperature Range is the ambient temperature range that the device-specific performance characteristics limits are valid. ACS37002L devices have optimized performance in the  $-40^{\circ}\text{C}$  to  $150^{\circ}\text{C}$  (“L” temperature) range. ACS37002K devices have optimized performance in the  $-40^{\circ}\text{C}$  to  $125^{\circ}\text{C}$  (“K” temperature) range. The  $-40^{\circ}\text{C}$  to  $125^{\circ}\text{C}$  (“K” temperature) range devices have Device Specific Performance optimized within the  $-40^{\circ}\text{C}$  to  $125^{\circ}\text{C}$  temperature range but will still operate in the  $-40^{\circ}\text{C}$  to  $150^{\circ}\text{C}$  (“L” temperature) range.

### DEFINITIONS OF OPERATING AND PERFORMANCE CHARACTERISTICS

#### Zero Current Voltage Output ( $V_{IOUT(Q)}$ , QVO)

Zero Current Voltage Output or  $V_{IOUT(Q)}$  (also called QVO) is defined as the voltage on the output,  $V_{IOUT}$  when zero amps are applied through  $I_P$ .

#### QVO Temperature Drift ( $V_{QE}$ )

QVO Temperature Drift, or  $V_{QE}$ , is defined as the drift of QVO from room to hot or room to cold (25°C to 125/150°C or 25°C to -40°C respectively). To improve over temperature performance the temperature drift is compensated with Allegro factory trim to remain within the limits across temperature.

#### Reference Voltage ( $V_{REF}$ )

There is a Voltage Reference Output, ( $V_{REF}$ ) on the ACS37002. This output reports the zero current voltage for the output channel  $V_{IOUT}$  allowing for differential measurement and a device referred supply for the VOC pin.

#### Reference Voltage Temperature Drift ( $V_{RE}$ )

Reference Voltage Temperature Drift, or  $V_{RE}$ , is defined as the drift of  $V_{REF}$  from room to hot or room to cold (25°C to 125/150°C or 25°C to -40°C respectively).

#### Offset Voltage ( $V_{OE}$ )

Offset Voltage, or  $V_{OE}$ , is defined as the difference between QVO and  $V_{REF}$  (see Figure 7).  $V_{OE}$  includes the drift of QVO minus  $V_{REF}$  from room to hot or room to cold (25°C to 125/150°C or 25°C to -40°C respectively).

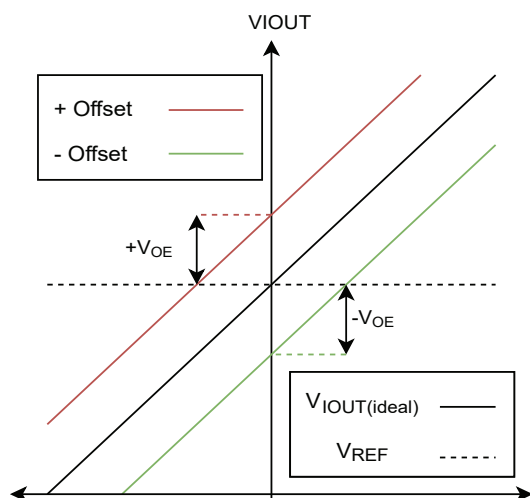

Figure 7: Offset ( $V_{OE}$ ) Between  $V_{IOUT}$  and  $V_{REF}$

#### Output Saturation Voltage ( $V_{SAT(HIGH/LOW)}$ )

Output Saturation Voltage, or  $V_{SAT}$ , is defined as the voltage that the  $V_{IOUT}$  does not pass as a result to an increasing magnitude of current.  $V_{SAT(HIGH)}$  is the highest voltage the output can drive to while,  $V_{SAT(LOW)}$  is the lowest. This can be seen in Figure 8. Note that changing the sensitivity does not change the  $V_{SAT}$  points.

#### OUTPUT VOLTAGE OPERATING RANGE ( $V_{OOR}$ )

The Output Voltage Operating Range, or  $V_{OOR}$ , is the functional range for linear performance of  $V_{IOUT}$  and its related datasheet parameters. This can be seen in Figure 8. The  $V_{OOR}$  is the output region that the performance accuracy parameters are valid. It is possible for the output to report beyond these voltages until  $V_{SAT}$ , but certain parameters cannot be guaranteed. The output performance is demonstrated in Figure 8 through and beyond the  $V_{OOR}$ .

Voltage Output Operating Range for $V_{CC}$ and Output Modes, $V_{OOR}(V_{CC}, Mode)$		
$V_{CC}$ (V)	Bidirectional	Unidirectional
3.3	$\pm 1.32$	+2.64
5	$\pm 2$	+4

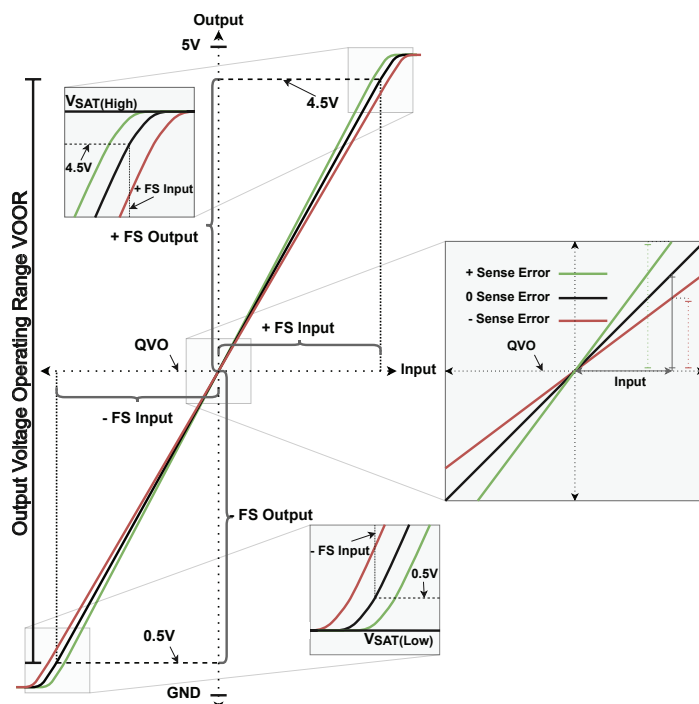

Figure 8:  $V_{OOR}$ ,  $V_{SAT}$  and SENS with Full Scale

### Sensitivity (Sens)

Sensitivity, or Sens, is the ratio of the output swing versus the applied current through the primary conductor,  $I_P$ . This current causes a voltage deviation away from QVO on the  $V_{IOUT}$  output until  $V_{SAT}$ . The magnitude and direction of the output voltage swing is proportional to the magnitude and direction of the applied current. This proportional relationship between output and input is Sensitivity and is defined as:

$$Sens = \frac{V_{IOUT(I1)} - V_{IOUT(I2)}}{I_1 - I_2}$$

where  $I_1$  and  $I_2$  are two different currents, and where  $V_{IOUT(I1)}$  and  $V_{IOUT(I2)}$  are the voltages of the device at the applied currents.  $V_{IOUT}$ ,  $I_1$ , or  $I_2$  can be QVO with zero current.

### Sensitivity Error ( $E_{sens}$ )

Sensitivity Temperature Drift, or  $E_{sens}$ , is the drift of Sens from room to hot or room to cold (25°C to 125°C or 25°C to -40°C respectively). No trimming/programming is needed as temperature drift is compensated with Allegro factory trim.

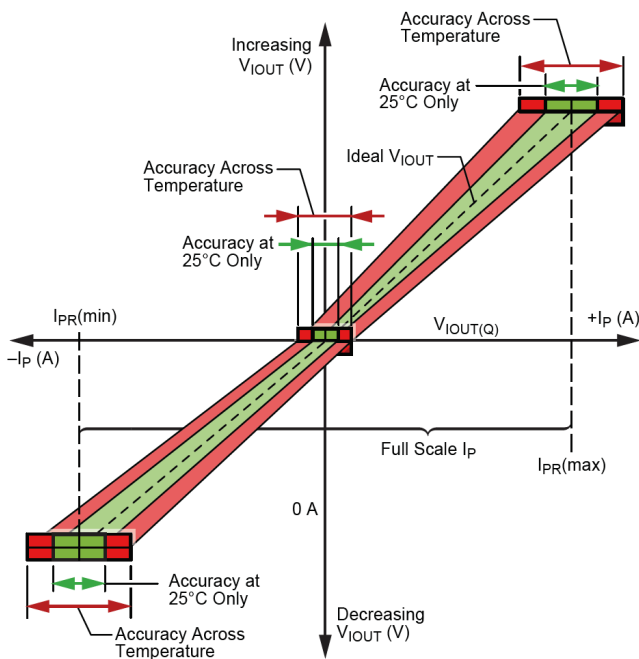

**Figure 9: Output Accuracy Pocket for Room and Across Temperature**

### Gain Selection Pins

The ACS37002 features external gain selection pins that configure the device sensitivity. The gain select logic is latched based on the pin voltage at startup. Either pin may be shorted directly to VCC or GND, which is logic 1 or 0 respectively. Both pins include an internal 1 MΩ pull-down resistor to GND. Externally floating pins will be interpreted as logic 0; if both pins are floating, the device will be in the 00 configuration. Specific gain select performance can be found in the selection Performance Characteristics table. To change the gain of the device, refer to Figure 18 in the Application and Theory section.

### Full Scale (FS)

Full Scale, or FS, is a method to relate an input and/or output to the max input and/or output of the device. For example, 50%FS of a 10A sensor is 5A, or 50% of its maximum input current. The 50% input of 5A will cause the output to move 50%, or 50%FS. FS is used to interchangeably refer to input and output deviations when discussing input steps, fault trip thresholds and relating input to output performance.  $FS_{INPUT}$  is the input bias that results in  $FS_{OUTPUT}$  and these two are directly related by the device actual sensitivity. Both FS input and output can be seen in Figure 8, labeled as positive or negative FS input and FS output. The equation for input referred FS for a 5V bidirectional device is:

$$FS = \frac{V_{OOR(5V,BI)}}{Sens_{Actual}} = \pm \frac{2V}{Sens_{Actual}}$$

Note: that a percentage change in  $FS_{INPUT}$  is equivalent to a resultant percentage change of  $FS_{OUTPUT}$  and visa versa.

### Nonlinearity ( $E_{LIN}$ )

As the amount of field applied to the part changes, the sensitivity of the device can also change slightly. This is referred to as linearity error or  $E_{LIN}$  (see Figure 10). Consider two currents,  $I_1$  (1/2 FS) and  $I_2$  (FS). Ideally, the sensitivity of the device is the same for both fields. Linearity Error is calculated as the percent change in sensitivity from one field to another. Error is calculated separately for positive ( $E_{LIN(+)}$ ) and negative ( $E_{LIN(-)}$ ) currents, and the percent errors are defined as:

$$E_{LIN(\pm)} = \left( 1 - \frac{Sens_{I2\pm}}{Sens_{I1\pm}} \right) \times 100\%$$

where:

$$Sens_{IX+} = \frac{V_{IOUT(IX+)} - V_{REF}}{I_{X+}}$$

$$Sens_{IX-} = \frac{V_{IOUT(IX-)} - V_{REF}}{I_{X-}}$$

$I_x$  are positive and negative currents through  $I_p$ , such that  $|I_{+2}| = 2 \times |I_{+1}|$  and  $|I_{-2}| = 2 \times |I_{-1}|$ .  $E_{LIN} = \max(E_{LIN(+)}, E_{LIN(-)})$

### Total Output Error ( $E_{TOT}$ )

The Total Output Error is the current measurement error from the sensor IC as a percentage of the actual applied current. This is equivalent to the difference between the ideal output voltage and the actual output voltage, divided by the ideal sensitivity, relative to the current applied to the device, or simplified to:

$$E_{TOT} = \frac{V_{IOUT(ACTUAL)} - (\text{Sens}_{(IDEAL)} \times I_{PR} + V_{REF})}{(\text{Sens}_{(IDEAL)} \times I_{PR})} \times 100$$

Total Output Error incorporates all sources of error and is a function of current. At relatively high currents, Total Output Error will be mostly due to sensitivity error, and at relatively low inputs, Total Output Error will be mostly due to Offset Voltage ( $V_{OE}$ ). At  $I = 0$  A, Total Output Error approaches infinity due to the offset. An example of total error at FS can be seen in Figure 10.

Note: Total Output Error goes to infinity as the amount of applied field approaches 0 A.

### Power Supply Offset Error ( $V_{PS}$ )

Power Supply Offset Error or  $V_{OE(PS)}$  is defined as the offset error in mV between  $V_{CC}$  and  $V_{CC} \pm 10\% V_{CC}$ . For a 5 V device, this is 5 to 4.5 V and 5 to 5.5 V. For a 3.3 V device, this is 3.3 to 3 V and 3.3 to 3.6 V.

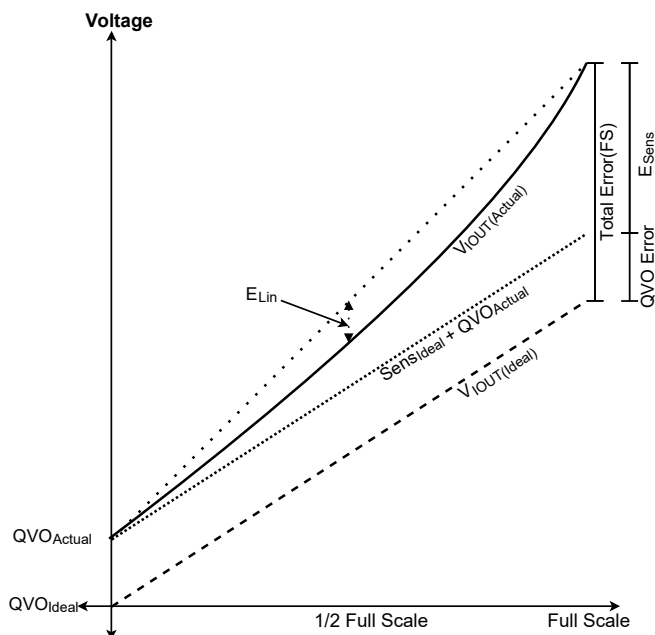

Figure 10: Accuracy Error

### Offset Power Supply Rejection Ratio (PSRR<sub>O</sub>)

The Offset Power Supply Rejection Ratio or PSRR<sub>O</sub> is defined as  $20 \times \log$  of the ratio of the change of QVO in volts over a  $\pm 100$  mV variable AC  $V_{CC}$  centered at 5 V reported as dB in a specified frequency range. This is an AC version of the  $V_{OE(PS)}$  parameter. The equation is shown below:

$$\text{PSRR}_O = 20 \times \log \left( \frac{\Delta QVO}{\Delta V_{CC}} \right)$$

### Power Supply Sensitivity Error ( $E_{PS}$ )

Power Supply Sensitivity Error, or  $E_{Sens(PS)}$ , is defined as the percent sensitivity error measured between  $V_{CC}$  and  $V_{CC} \pm 10\%$ . For a 5 V device, this is 5 to 4.5 V and 5 to 5.5 V. For a 3.3 V device, this is 3.3 to 3 V and 3.3 to 3.6 V.

### Sensitivity Power Supply Rejection Ratio (PSRR<sub>S</sub>)

The Sensitivity Power Supply Rejection Ratio or PSRR<sub>S</sub> is defined as  $20 \times \log$  of the ratio of the % change the sensitivity over the % change in  $V_{CC}$  ( $\pm 100$  mV variable AC  $V_{CC}$  centered at 5 V) reported as dB in a specified frequency range. This is the AC version of the  $E_{Sens(PS)}$  parameter. The equation is shown below:

$$\text{PSRR}_S = 20 \times \log \left( \frac{\Delta \% \text{Sens}}{\Delta V_{CC}} \right)$$



## FAULT BEHAVIOR

### Overcurrent Fault (OCF)

As the output swings, the Overcurrent Fault pin will trigger with an active low flag if the sensed current exceeds its comparator threshold. This is internally compared with either the factory-programmed thresholds or via the VOC voltage when  $V_{VOC} > 0.1$  V. This flag trips symmetrically for the positive and negative OCF operating point.

The implementation for the OCF circuitry is accurate over temperature and does not require further temperature compensation as it is dependent on the Sens and  $V_{OFF}$  parameters that are factory-trimmed flat over temperature.

### OVERCURRENT FAULT OPERATING RANGE/POINT ( $I_{OCF-OR}$ , $I_{OCF-OP}$ )

Overcurrent Fault Operating Range is the functional range that the OCF thresholds can be set in terms of percentage of full-scale output swing. The Overcurrent Fault Operating Point is the specific point at which the OCF trigger will occur, and is set by either  $V_{VOC}$  or the factory default setting. The  $I_{OCF-OP}$  can be seen in Figure 11 as [9] along with the FAULT pin functionality.

### OVERCURRENT FAULT HYSTERESIS ( $I_{OCF-HYST}$ )

Overcurrent Fault Hysteresis or  $I_{OCF-HYST}$  is defined as the magnitude of percent FS that must drop before a fault assertion will be cleared. This can be seen as the separation between the voltages [9] to [10] in Figure 11. Note the MASK and HOLD functionality are independent of each other. The ACS37002 comes standard with an  $OCF_{HYS}$  of 120 mV (on the output) or 6%FS for a 5 V device and 9%FS for a 3.3 V device.

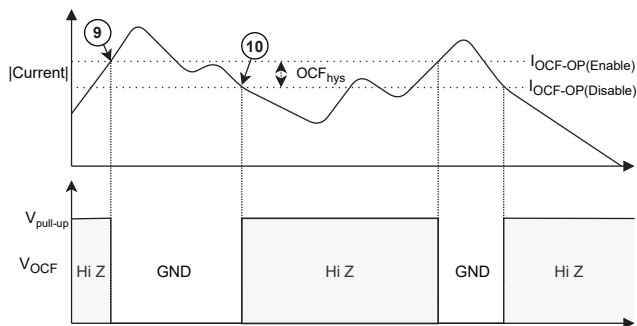

Figure 11: Fault Thresholds and OCF Pin Functionality

### VOLTAGE OVERCURRENT PIN (VOC)

The fault trip points can be set using the VOC pin as the direct analog input for the fault trip point. The VOC pin voltage can be set using resistor dividers from  $V_{REF}$  on bidirectional devices. The fault performance is valid when  $V_{VOC}$  is within the VOC Operating Voltage Range or  $< 0.1$  V. The device will respond to voltage outside of the defined valid performance region with varied results. For a 5 V bidirectional device, setting the VOC pin to 0.5 V selects the minimum trip point,  $I_{FAULT(min)}$ , and setting the pin to 2 V selects the maximum trip point,  $I_{FAULT(max)}$  as defined by selection performance tables. All voltages between 0.5 to 2 V for 5 V option and 0.33 to 1.321 V for 3.3 V option can linearly select a trip point between the minimum and maximum levels, as shown in Figure 12. When  $V_{OC} < 0.1$  V, the internal EEPROM fault level will be used.

The resulting equation for the fault is:

$$OCF_{\%FS} [\%] = \frac{V_{OC(VCC)} [V]}{V_{OC(VCC)100\%} [V]} \times 100 [\%]$$

$$I_{OCF} [A] = OCF_{\%FS} [\%] \times I_{PR} [A]$$

Table 1:  $V_{OC(VCC)}$  thresholds and corresponding percentage of the Full-Scale Output for Bidirectional and Unidirectional operational modes

$V_{OC(3.3V)}$ (V)	$V_{OC(5V)}$ (V)	Fault Operation Point %FS	
		Bidirectional	Unidirectional
<0.1		100% (factory default)	50% (factory default)
0.330	0.5	50%	25%
0.466	0.75	75%	37.5%
0.661	1	100%	50%
0.826	1.25	125%	62.5%
0.991	1.5	150%	75%
1.156	1.75	175%	85%
1.321	2	200%	100%

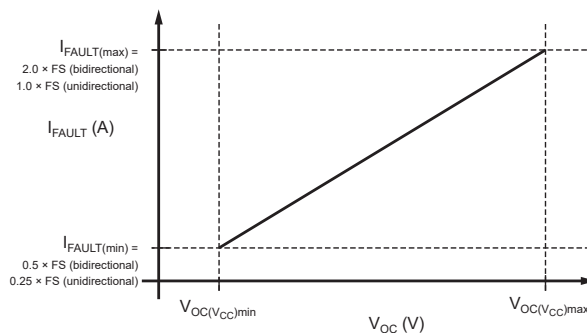

Figure 12: VOC Functional Range

### OVERCURRENT FAULT ERROR ( $E_{OCF}$ )

Fault Error or  $E_{OCF}$  is the error between the  $I_{OCF-OP(actual)}$  and  $I_{OCF-OP(ideal)}$ .

### OVERCURRENT FAULT RESPONSE TIME ( $t_{OCF}$ )

Overcurrent Response Time or  $t_{OCF}$  is defined as the time from the input reaches the operating point [9] (seen in Figure 13) until the OCF pin falls below  $V_{FAULT-ON}$  [G]. If the OCF Mask is disabled, then  $t_{OCF}$  is equal to  $t_{OCF-R}$  seen as the time from [9] until [F].

### OVERCURRENT FAULT REACTION TIME ( $t_{OCF-R}$ )

Overcurrent Reaction Time or  $t_{OCF-R}$  is defined as the time from the current input rising above  $I_{OCF-OP}$  at point [9] in Figure 13 until the OCF pin reaches  $V_{OCF-ON}$  at point [F] with the OCF mask disabled. This is the time required for the device to recognize and clear the fault, seen as the time between [10] until [I].

### OVERCURRENT FAULT MASK TIME ( $t_{OCF-MASK}$ )

Overcurrent Fault Mask Time or  $t_{OCF-MASK}$  is defined as the additional amount of time the OCF must be present beyond the  $t_{OCF-R}$  time (seen in Figure 13 [F] until [G]). This is to reduce nuisance tripping of the FAULT pin. If an OCF occurs, but does not persist beyond  $t_{OCF-R} + t_{OCF-MASK}$ , it is not reported by the device (seen in Figure 14). This prevents short transient spikes from causing erroneous OCF flagging. Factory default setting is  $t_{OCF-MASK} = 0 \mu s$ .

### OVERCURRENT FAULT HOLD TIME ( $t_{OCF-HOLD}$ )

Overcurrent Fault Hold Time or  $t_{OCF-HOLD}$  is defined as the minimum time OCF flag will be asserted after a sufficient OCF event. After the hold time has been reached, the OCF will release if the OCF condition has ended (seen in Figure 13 [G] until [J]) or persist if the OCF condition is still present (seen in Figure 15 [G] until [J]). Factory default is 0 ms.

### OVERCURRENT FAULT PERSIST

The ACS37002 has a fault persist option that will maintain the OCF flag if a flag occurred until a POR event.

### OCF DISABLE

The ACS37002 has the ability to disable overcurrent fault functionality; when this is disabled, the OCF pin will remain in high Z.

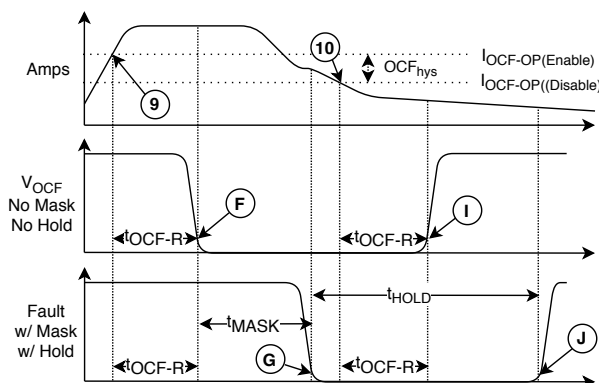

**Figure 13: General Fault Timing.**  
Note: the MASK and HOLD functionality are independent of each other

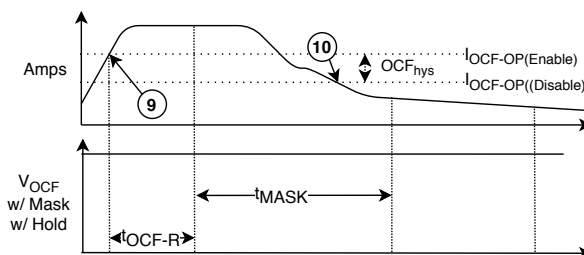

**Figure 14: Fault Condition Clearing Before Mask Time Is Reached**

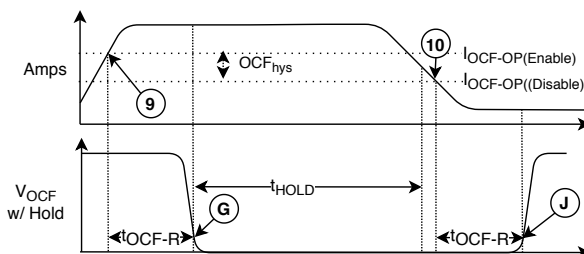

**Figure 15: Fault Hold with Clear Fault After Hold Time**



RESPONSE CHARACTERISTICS DEFINITIONS AND PERFORMANCE DATA

**Response Time ( $t_{RESPONSE}$ )**

The time interval between a) when the sensed input current reaches 90% of its final value, and b) when the sensor output reaches 90% of its full-scale value.

**Propagation Delay ( $t_{pd}$ )**

The time interval between a) when the sensed input current reaches 20% of its full-scale value, and b) when the sensor output reaches 20% of its full-scale value.

**Rise Time ( $t_r$ )**

The time interval between a) when the sensor reaches 10% of its full-scale value, and b) when it reaches 90% of its full-scale value.

**Output Slew Rate (SR)**

The rate of change [V/ $\mu$ s] in the output voltage from a) when the sensor reaches 10% of its full-scale value, and b) when it reaches 90% of its full-scale value.

**Response Time, Propagation Delay, Rise Time, and Output Slew Rate**

Applied current step with 10%-90% rise time = 1  $\mu$ s

Test Conditions:  $T_A = 25^\circ\text{C}$ ,  $C_{BYPASS} = 0.1 \mu\text{F}$ ,  $C_L = 6 \text{ nF}$

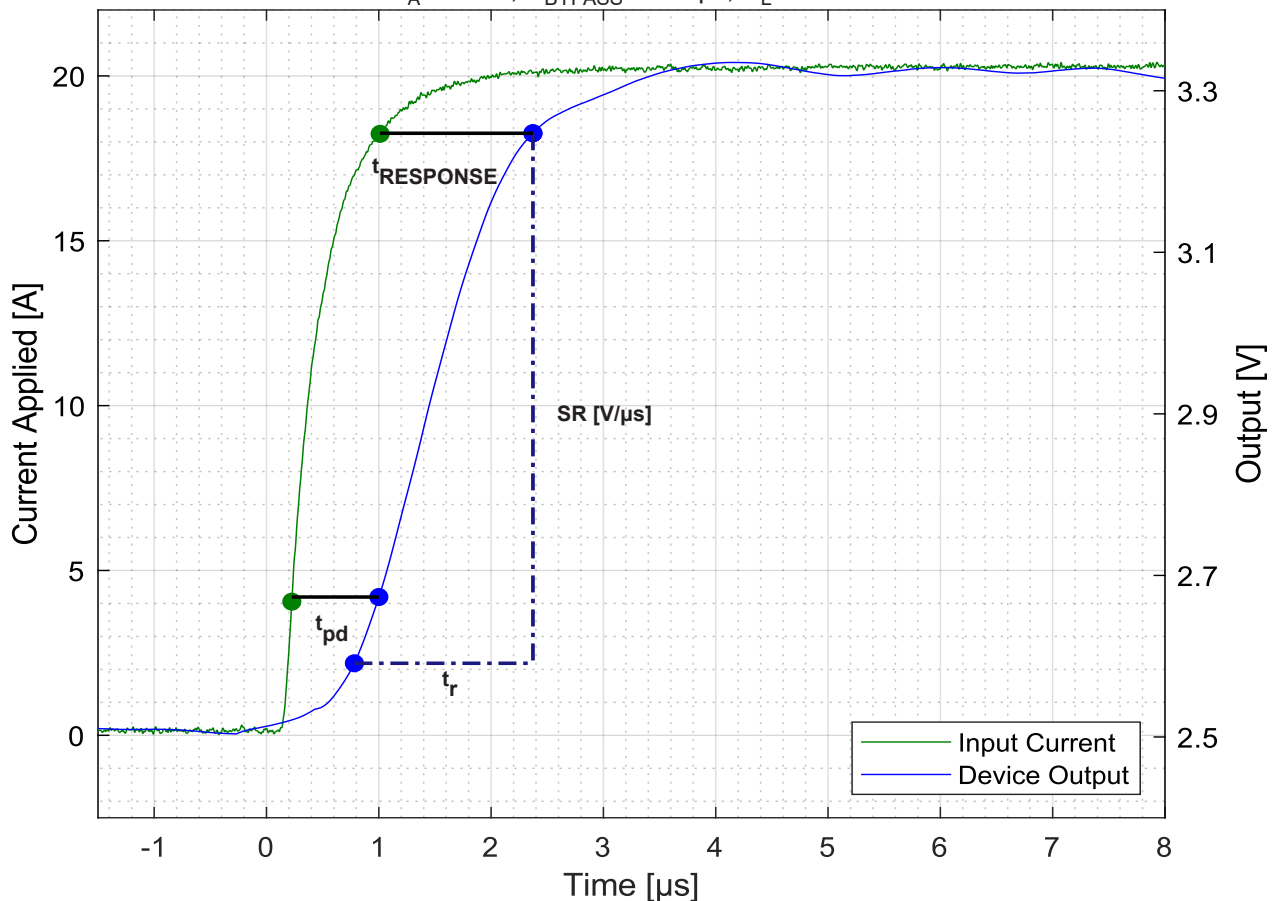

### Temperature Compensation

To help compensate for the effects temperature has on performance, the ACS37002 has an integrated internal temperature sensor. This sensor and compensation algorithms help to standardize device performance over the full range of optimized temperatures. This allows for room temperature system calibration and validation of end-of-line modules.

### Temperature Compensation Update Rate

There is an 8 ms update time that is required to maintain a valid temperature compensated output; that is, temperature compensations are calculated and applied every 8 ms.

### APPLICATION AND THEORY

#### Application Circuits

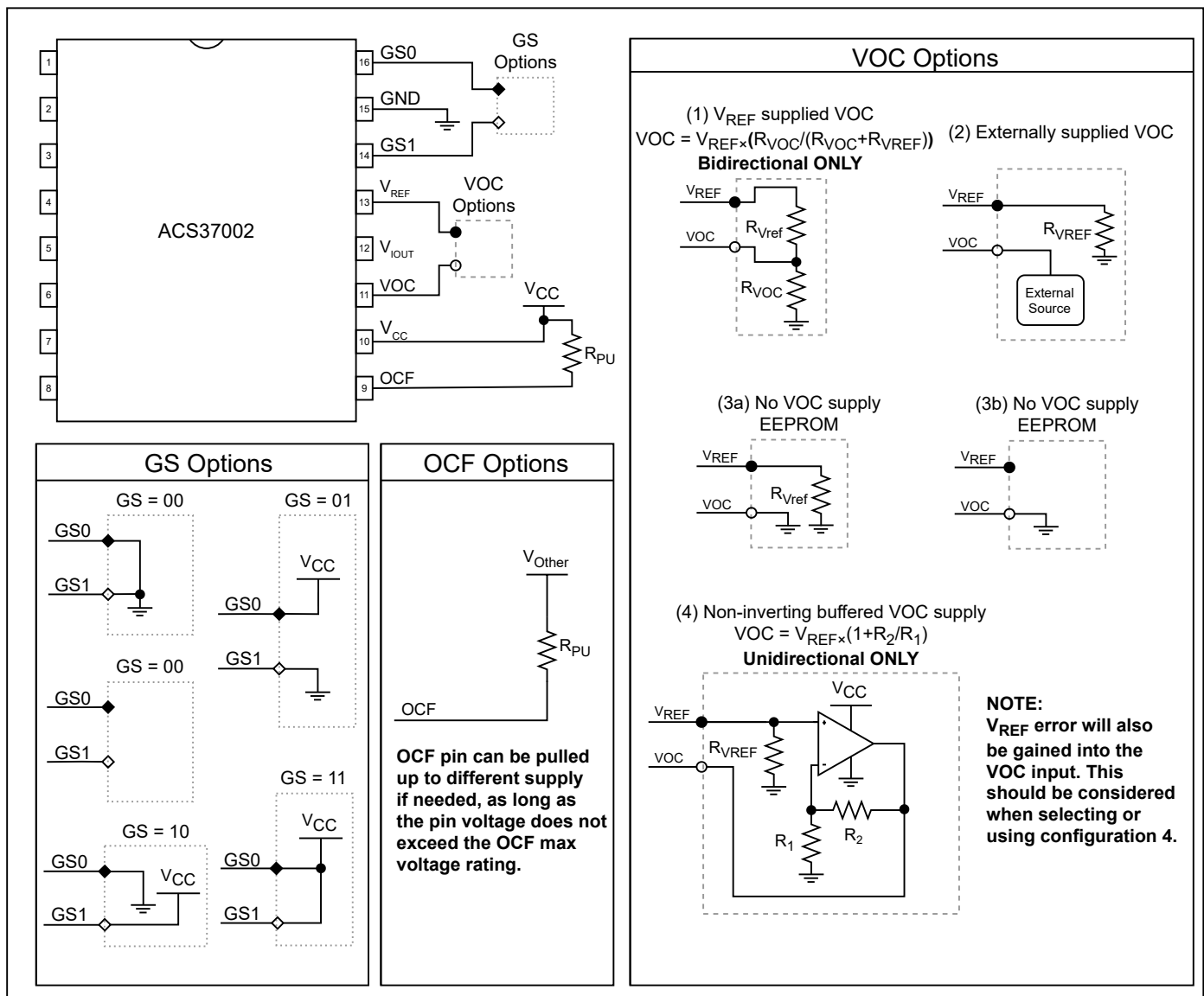

**Figure 16: Applications Circuits for GAIN\_SEL, VOC, and FAULT pin**

These configurations are simplified to the network required for functionality.

Bypass and load capacitors are recommend for best performance.

Theory and Functionality – VOC and OCF

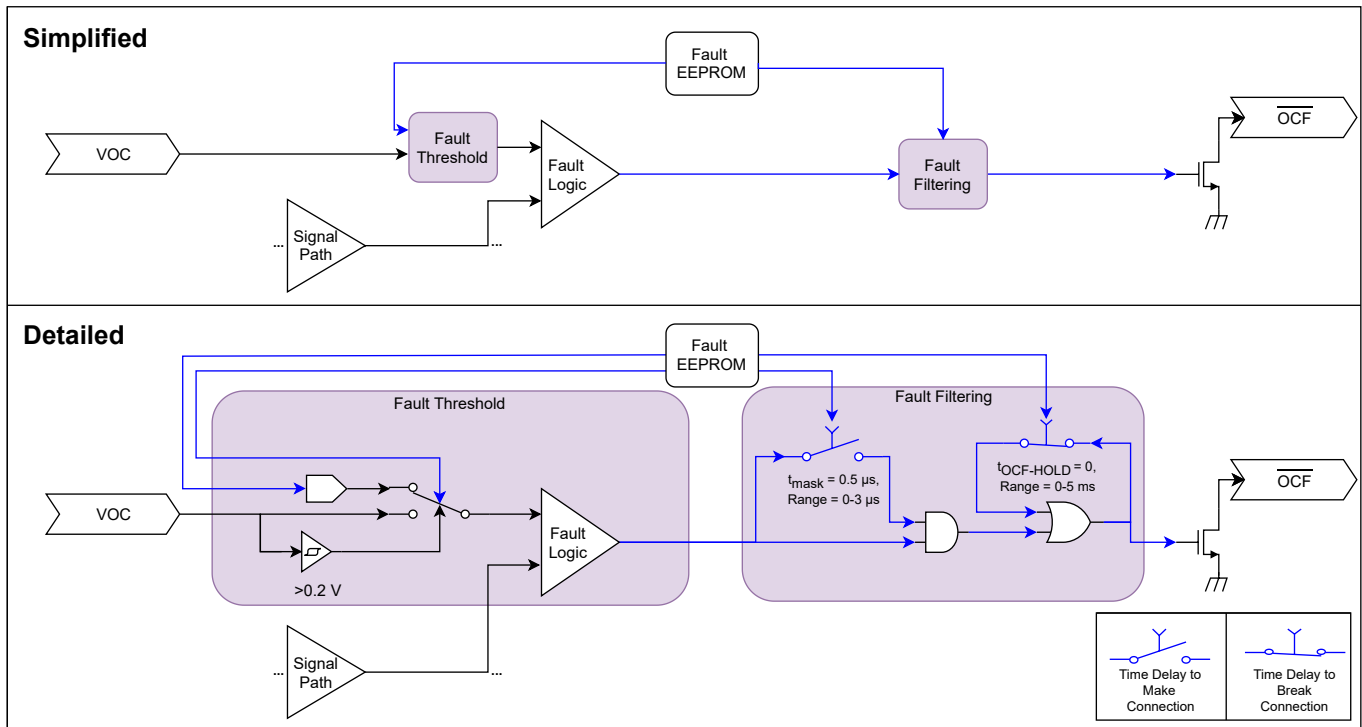

Figure 17: OCF Signal Path Simplified and Detailed Blocks of Functionality

VOC DRIVEN BY NON-INVERTING BUFFERED VREF

If the VOC pin is being driven by a non-inverted buffered  $V_{REF}$ , it is important to consider that any error from the  $V_{REF}$  pin will be gained as well. For instance, if  $V_{REF}$  error is +10 mV and the gain = 4 for the non-inverting operational amplifier, then the VOC pin will be 40 mV from the expected target. For unidirectional devices, OCF would be subjected to an additional 4% error due to the error propagation from  $V_{REF}$  through the gain stage.

POWER SUPPLY DECOUPLING CAPACITOR AND OUTPUT CAPACITIVE LOADS

The higher the capacitive load on the outputs ( $V_{REF}$ ,  $V_{IOUT}$ ), the larger the decoupling capacitor should be on the power supply ( $V_{CC}$ ) to maintain performance.

$C_{LOAD}$	$C_{BYPASS}$
0 nF	>100 nF
1 nF	>100 nF
3 nF	>1 $\mu$ F
6 nF	>10 $\mu$ F

### Dynamically Change Gain in a System

The ACS37002 has GAIN\_SEL pins that are used to change the gain of the device on startup. If a more dynamic gain is desired, then reduce  $V_{CC}$  below  $V_{POR(L)}$  and restart the device by returning  $V_{CC}$  to the nominal voltage with the new desired GAIN\_SEL configuration. The GAIN\_SEL pin voltage must greater than the

desired configuration voltage ( $V_{H(SEL)}$  or  $V_{L(SEL)}$ ) at or before  $V_{CC} > V_{POR(H)}$  in order to successfully change the device gain. The GAIN\_SEL pin voltage is latched at startup, and any changes to the pin voltages after the devices  $V_{IOUT}$  comes out of high Z will not affect gain. The cycle time to complete this operation is up to  $2 \times t_{POD}$ .

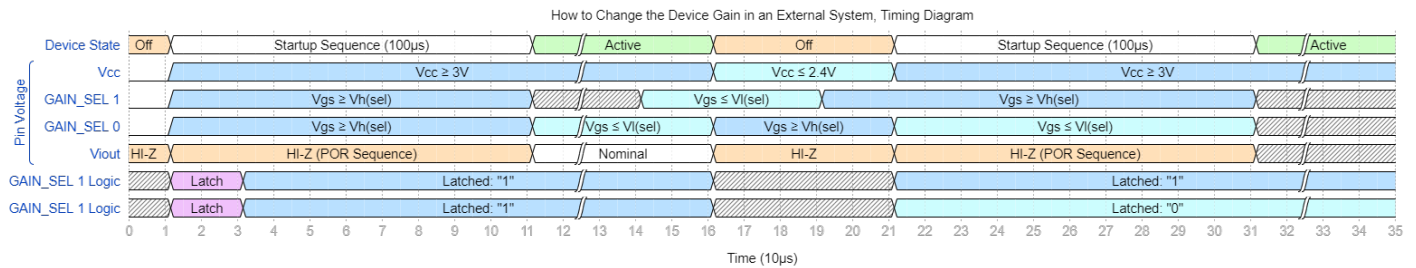

Figure 18: GAIN\_SEL Dynamic Gain Changing Timing Diagram

## THERMAL PERFORMANCE

### Thermal Rise vs. Primary Current

Self-heating due to the flow of current should be considered during the design of any current sensing system. The sensor, printed circuit board (PCB), and contacts to the PCB will generate heat as current moves through the system.

The thermal response is highly dependent on PCB layout, copper thickness, cooling techniques, and the profile of the injected current. The current profile includes peak current, current “on-time”, and duty cycle. While the data presented in this section was collected with direct current (DC), these numbers may be used to approximate thermal response for both AC signals and current pulses.

The plot in Figure 19 shows the measured rise in steady-state die temperature of the ACS37002 versus continuous current at an ambient temperature,  $T_A$ , of 25 °C. The thermal offset curves may be directly applied to other values of  $T_A$ . Conversely, Figure 20 shows the maximum continuous current at a given  $T_A$ . Surges beyond the maximum current listed in Figure 21 are allowed given the maximum junction temperature,  $T_{J(MAX)}$  (165°C), is not exceeded.

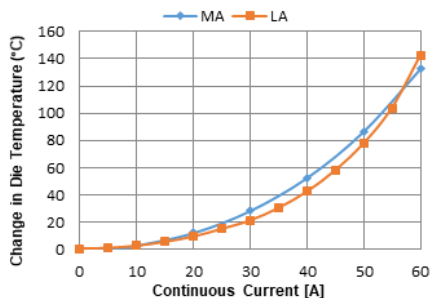

**Figure 19: Self heating in the MA and LA package due to current flow**

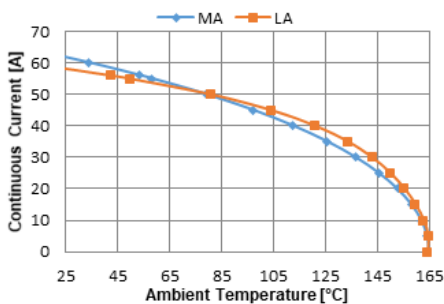
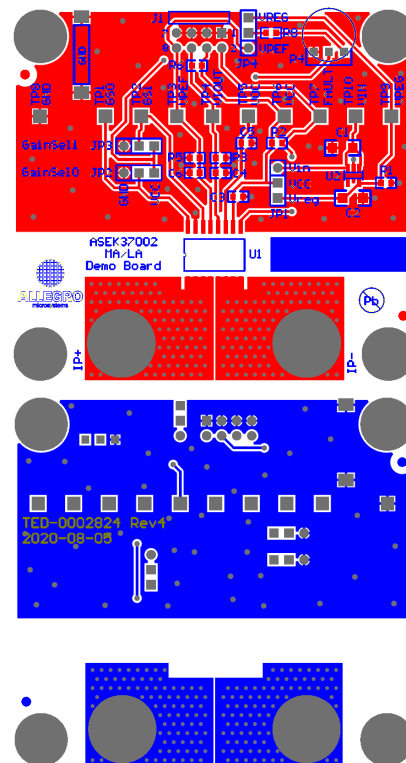

**Figure 20: Maximum Continuous Current at a Given  $T_A$**

The thermal capacity of the ACS37002 should be verified by the end user and is specific to the application. The maximum junction temperature,  $T_{J(MAX)}$  (165°C), should not be exceeded. Further information on this application testing is available in the DC and Transient Current Capability application note on the Allegro website (<http://www.allegromicro.com/en/Design-Center/Technical-Documents/Hall-Effect-Sensor-IC-Publications/DC-and-Transient-Current-Capability-Fuse-Characteristics.aspx>).

### Evaluation Board Layout

Thermal data shown in Figure 19 and Figure 20 was collected using the ASEK37002 Evaluation Board (TED-0002825). This board includes 750 mm<sup>2</sup> of 4 oz. copper (0.1388 mm) connected to pins 1 through 4, and to pins 5 through 8, with thermal vias connecting the layers. Top and bottom layers of the PCB are shown below in Figure 21.



**Figure 21: Top and Bottom Layers for ASEK37002 Evaluation Board**

Gerber files for the ASEK37002 evaluation board are available for download from the Allegro website. See the technical documents section of the ACS37002 webpage (<https://www.allegromicro.com/en/products/sense/current-sensor-ics/zero-to-fifty-amp-integrated-conductor-sensor-ics/acs37002>).

PACKAGE OUTLINE DRAWINGS

For Reference Only – Not for Tooling Use

(Reference MS-013AA)

NOT TO SCALE

Dimensions in millimeters

Dimensions exclusive of mold flash, gate burrs, and dambar protrusions  
Exact case and lead configuration at supplier discretion within limits shown

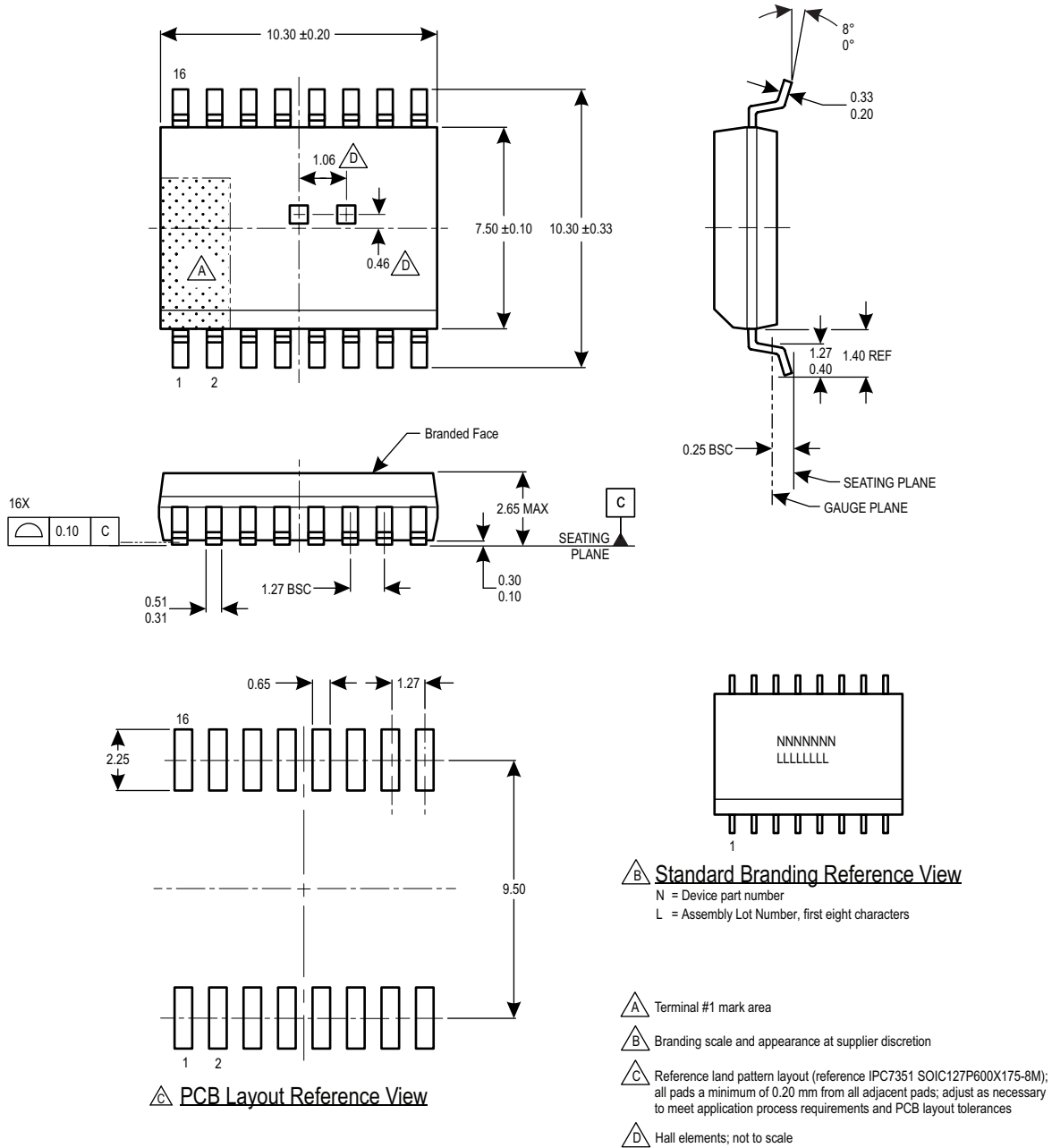

Figure 22: Package MA, 16-Pin SOICW

# ACS37002

## 400 kHz, High Accuracy Current Sensor with Pin-Selectable Gains and Adjustable Overcurrent Fast Fault in SOICW-16 Package

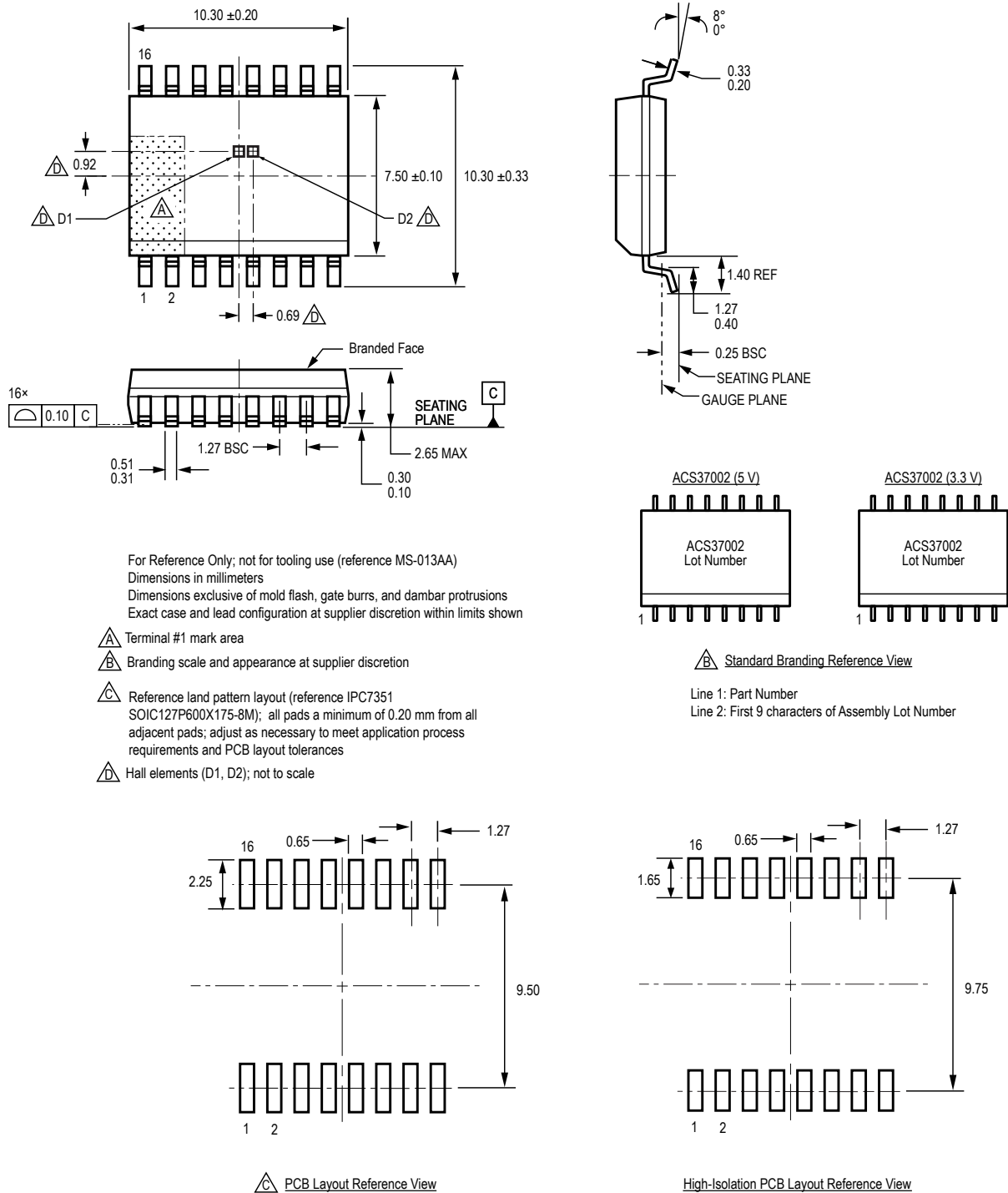

Figure 23: Package LA, 16-PIN SOICW