

High Isolation Linear Current Sensor IC with 850 $\mu\Omega$ Current Conductor

FEATURES AND BENEFITS

- IEC/UL 60950-1 Ed. 2 certified to:
 - Dielectric Strength = 4800 Vrms (tested for 60 seconds)
 - Basic Isolation = 1550 Vpeak
 - Reinforced Isolation = 800 Vpeak
- Small footprint, low-profile SOIC16 wide-body package suitable for space constrained applications that require high galvanic isolation
- 0.85 m Ω primary conductor for low power loss and high inrush current withstand capability
- Low, 350 $\mu\text{A}_{\text{RMS}}/\sqrt{\text{Hz}}$ noise density results in typical input referred noise of 70 mA(rms) at max bandwidth (40 kHz)
- 5.0 V, single supply operation
- Output voltage proportional to AC or DC current
- Factory-trimmed sensitivity and quiescent output voltage for improved accuracy
- Chopper stabilization results in extremely stable quiescent output voltage
- Ratiometric output from supply voltage



TÜV America
Certificate Number:
U8V 16 03 54214 040
CB 16 03 54214 039



CB Certificate Number:
US-32210-M1-UL

Package: 16-Pin SOICW (suffix MA)

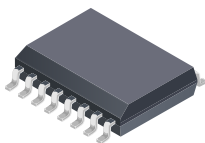

Not to scale

DESCRIPTION

The Allegro™ ACS718 current sensor IC is an economical, high isolation solution for AC or DC current sensing in industrial, commercial, and communications systems. The small package is ideal for space constrained applications, though the wide-body provides the creepage and clearance needed for high isolation. Typical applications include motor control, load detection and management, switched-mode power supplies, and overcurrent fault protection.

The device consists of a low-offset, linear Hall sensor circuit with a copper conduction path located near the surface of the die. Applied current flowing through this copper conduction path generates a magnetic field which is sensed by the integrated Hall IC and converted into a proportional voltage. Device accuracy is optimized through the close proximity of the magnetic field to the Hall transducer. A proportional voltage is provided by the low-offset, chopper-stabilized BiCMOS Hall IC, which is programmed for accuracy after packaging. The output of the device has a positive slope when an increasing current flows through the primary copper conduction path (from pins 1 through 4, to pins 5 through 8), which is the path used for current sensing. The internal resistance of this conductive path is 0.85 m Ω typical, providing low power loss.

The terminals of the conductive path are electrically isolated from the sensor leads (pins 10 through 15). This allows the ACS718 current sensor IC to be used in high-side current sense applications without the use of high-side differential amplifiers or other costly isolation techniques.

The ACS718 is provided in a small, low profile surface mount SOICW16 package (suffix MA). The device is lead (Pb) free with 100% matte tin leadframe plating. The device is fully calibrated prior to shipment from the factory.

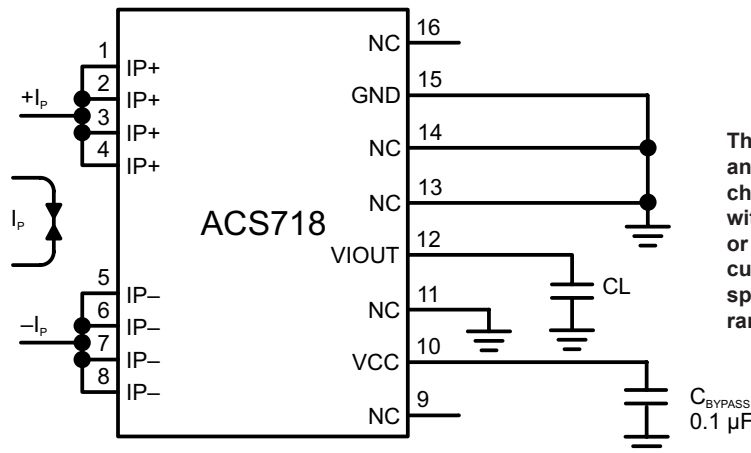

The ACS718 outputs an analog signal, V_{IOUOUT} , that changes, proportionally, with the bidirectional AC or DC primary sensed current, I_p , within the specified measurement range.

Typical Application

SPECIFICATIONS

SELECTION GUIDE

Part Number	I_P (A)	Sens(Typ) at $V_{CC} = 5.0\text{ V}$ (mV/A)	T_A (°C)	Packing [1]
ACS718KMATR-10B-T [2]	± 10	200	-40 to 125	Tape and reel, 1000 pieces per reel
ACS718KMATR-20B-T [2]	± 20	100		



[1] Contact Allegro for additional packing options.

[2] Variant not intended for automotive applications.

ABSOLUTE MAXIMUM RATINGS

Characteristic	Symbol	Notes	Rating	Units
Supply Voltage	V_{CC}		7	V
Reverse Supply Voltage	V_{RCC}		-0.1	V
Output Voltage	V_{IOUT}		25	V
Reverse Output Voltage	V_{RIOUT}		-0.1	V
Maximum Continuous Current	I_{CMAX}	$T_A = 25^\circ\text{C}$	60	V
Operating Ambient Temperature	T_A	Range K	-40 to 125	°C
Junction Temperature	$T_{J(max)}$		165	°C
Storage Temperature	T_{stg}		-65 to 165	°C

ESD RATINGS

Characteristic	Symbol	Notes	Rating	Units
Human Body Model	V_{HBM}		± 8	kV
Charged Device Model	V_{CDM}		± 1	kV

ISOLATION CHARACTERISTICS

Characteristic	Symbol	Notes	Rating	Unit
Dielectric Strength Test Voltage	V_{ISO}	Agency type tested for 60 seconds per IEC/UL 60950-1 (2nd Edition). Production tested for 1 second at 3000 V_{RMS} in accordance with IEC/UL 60950-1 (2nd Edition).	4800	V_{RMS}
Working Voltage for Basic Isolation	V_{WVBI}	Maximum approved working voltage for basic (single) isolation according to IEC/UL 60950-1 (2nd Edition).	1550	V_{PK} or VDC
			1097	V_{RMS}
Working Voltage for Reinforced Isolation	V_{WVRI}	Maximum approved working voltage for reinforced isolation according to IEC/UL 60950-1 (2nd Edition)	800	V_{PK} or VDC
			565	V_{RMS}
Clearance	D_{cl}	Minimum distance through air from IP leads to signal leads.	7.5	mm
Creepage [1]	D_{cr}	Minimum distance along package body from IP leads to signal leads.	8.2	mm
Distance Through Insulation	DTI	Minimum internal distance through insulation	90	μm
Comparative Tracking Index	CTI	Material Group II	400 to 599	V

[1] In order to maintain this creepage in applications, the user should add a slit in the PCB under the package. Otherwise, the pads on the PCB will reduce the creepage.

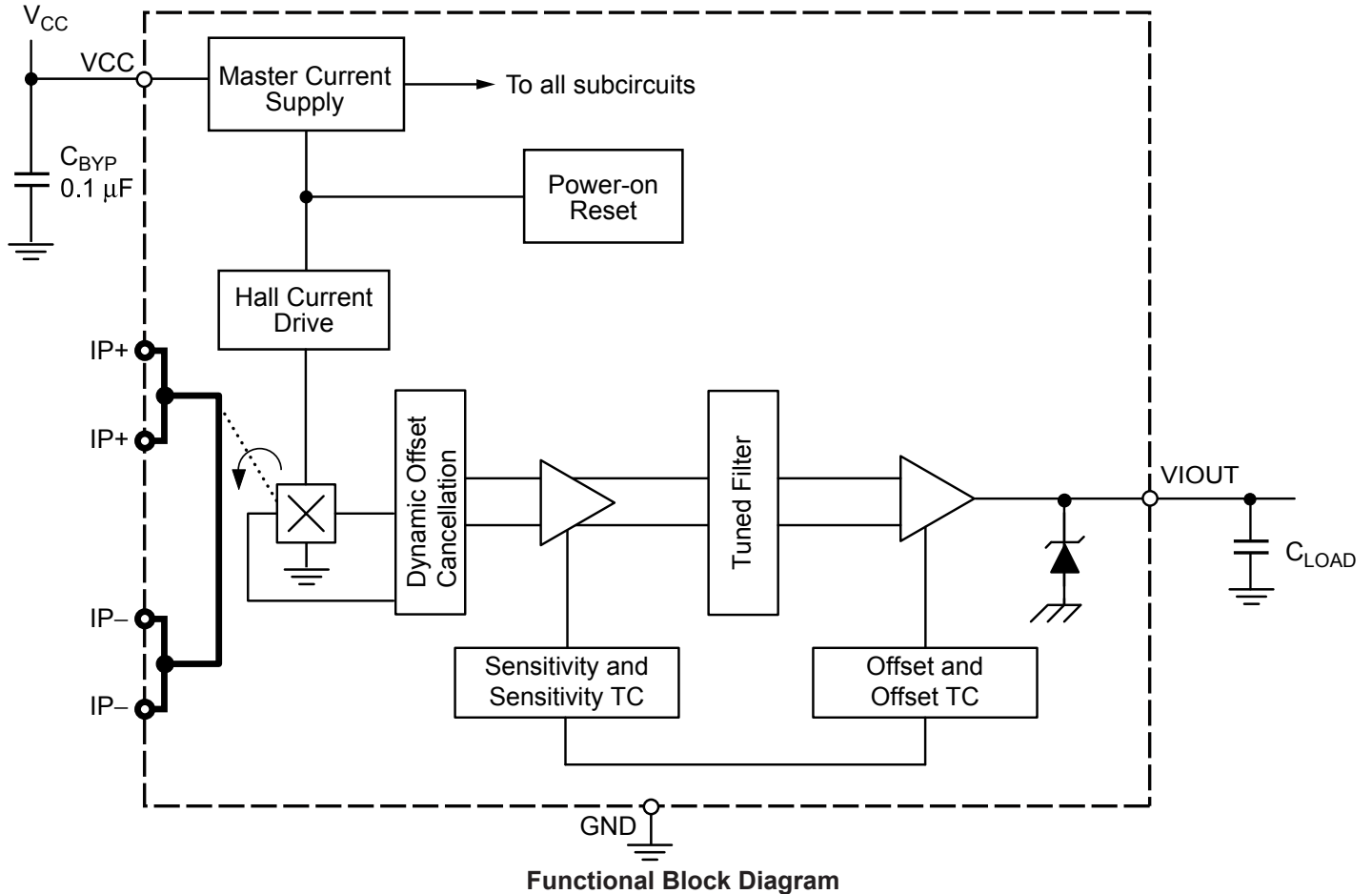

Pinout Diagram and Terminal List Table

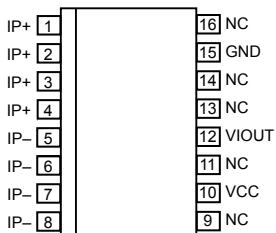

**Package MA, 16-Pin
SOICW**

Terminal List

Number	Name	Description
1, 2, 3, 4	IP+	Terminals for current being sensed; fused internally
5, 6, 7, 8	IP-	Terminals for current being sensed; fused internally
9, 16	NC	No internal connection; recommended to be left unconnected in order to maintain high creepage.
11, 13, 14	NC	No internal connection; recommended to connect to GND for the best ESD performance
10	VCC	Device power supply terminal
12	VIOUT	Analog output signal
15	GND	Signal ground terminal

COMMON ELECTRICAL CHARACTERISTICS [1]: T_A Range K, valid at $T_A = -40^\circ\text{C}$ to 125°C , $V_{CC} = 5\text{ V}$, unless otherwise specified

Characteristic	Symbol	Test Conditions	Min.	Typ.	Max.	Units
Supply Voltage	V_{CC}		4.5	5	5.5	V
Supply Current	I_{CC}	$V_{CC} = 5\text{ V}$, output open	–	7	9	mA
Output Capacitance Load	C_L	VIOOUT to GND	–	–	1	nF
Output Resistive Load	R_L	VIOOUT to GND	15	–	–	k Ω
Primary Conductor Resistance	R_P	$T_A = 25^\circ\text{C}$	–	0.85	–	m Ω
Primary Conductor Inductance	L_{IP}	$T_A = 25^\circ\text{C}$	–	4	–	nH
Magnetic Coupling Factor	C_F		–	4.5	–	G/A
Rise Time	t_r	$T_A = 25^\circ\text{C}$, $C_L = 0\text{ nF}$	–	10	–	μs
Propagation Delay	t_{pd}	$T_A = 25^\circ\text{C}$, $C_L = 0\text{ nF}$	–	5	–	μs
Response Time	$t_{RESPONSE}$	$T_A = 25^\circ\text{C}$, $C_L = 0\text{ nF}$	–	13	–	μs
Output Slew Rate	SR	$T_A = 25^\circ\text{C}$, $C_L = 0\text{ nF}$	–	0.16	–	V/ μs
Internal Bandwidth	BWi	Small signal –3 dB	–	40	–	kHz
Noise Density	I_{ND}	Input referenced noise density; $T_A = 25^\circ\text{C}$, $C_L = 1\text{ nF}$	–	350	–	$\mu\text{A}_{(rms)}/\sqrt{\text{Hz}}$
Noise	I_N	Input referenced noise; BWi = 40 kHz, $T_A = 25^\circ\text{C}$, $C_L = 1\text{ nF}$	–	70	–	$\text{mA}_{(rms)}$
Nonlinearity	E_{LIN}	Across full range of I_P	–	± 1	–	%
Saturation Voltage [2]	V_{OH}	$R_L = R_L(\text{min})$	$V_{CC} - 0.3$	–	–	V
	V_{OL}	$R_L = R_L(\text{min})$	–	–	0.3	V
Power-On Time	t_{PO}	$T_A = 25^\circ\text{C}$	–	35	–	μs

[1] Device may be operated at higher primary current levels, I_P , ambient temperatures, T_A , and internal leadframe temperatures, provided the Maximum Junction Temperature, $T_J(\text{max})$, is not exceeded.

[2] The sensor IC will continue to respond to current beyond the range of I_P until the high or low saturation voltage; however, the nonlinearity in this region will be worse than through the rest of the measurement range.

**xKMATR-10B PERFORMANCE CHARACTERISTICS: Valid at $T_A = -40^\circ\text{C}$ to 125°C , $V_{CC} = 5\text{ V}$,
unless otherwise specified**

Characteristic	Symbol	Test Conditions	Min.	Typ. [1]	Max.	Units
NOMINAL PERFORMANCE						
Current Sensing Range	I_{PR}		-10	-	10	A
Sensitivity	Sens	$I_{PR(\text{min})} < I_P < I_{PR(\text{max})}$	-	200	-	mV/A
Zero Current Output Voltage	$V_{IOUT(Q)}$	Bidirectional; $I_P = 0\text{ A}$	-	$V_{CC} \times 0.5$	-	V
ACCURACY PERFORMANCE						
Total Output Error [2]	E_{TOT}	$I_P = I_{PR(\text{max})}$; $T_A = 25^\circ\text{C}$	-5	± 2	5	%
		$I_P = I_{PR(\text{max})}$; $T_A = 85^\circ\text{C}$	-	± 2	-	%
		$I_P = I_{PR(\text{max})}$; $T_A = 125^\circ\text{C}$	-	± 4	-	%
		$I_P = I_{PR(\text{max})}$; $T_A = -40^\circ\text{C}$	-	± 4	-	%
TOTAL OUTPUT ERROR COMPONENTS [3] $E_{TOT} = E_{SENS} + 100 \times V_{OE} / (\text{Sens} \times I_P)$						
Sensitivity Error	E_{SENS}	$T_A = 25^\circ\text{C}$; measured at $I_P = I_{PR(\text{max})}$	-4	± 2	4	%
		$T_A = 85^\circ\text{C}$; measured at $I_P = I_{PR(\text{max})}$	-	± 2	-	%
		$T_A = 125^\circ\text{C}$; measured at $I_P = I_{PR(\text{max})}$	-	± 3	-	%
		$T_A = -40^\circ\text{C}$; measured at $I_P = I_{PR(\text{max})}$	-	± 4	-	%
Voltage Offset Error [4]	V_{OE}	$T_A = 25^\circ\text{C}$; $I_P = 0\text{ A}$	-40	± 10	40	mV
		$T_A = 85^\circ\text{C}$; $I_P = 0\text{ A}$	-	± 15	-	mV
		$T_A = 125^\circ\text{C}$; $I_P = 0\text{ A}$	-	10 ± 20	-	mV
		$T_A = -40^\circ\text{C}$; $I_P = 0\text{ A}$	-	± 25	-	mV
LIFETIME DRIFT CHARACTERISTICS						
Sensitivity Error Lifetime Drift	E_{SENS_DRIFT}		-	± 2	-	%
Total Output Error Lifetime Drift	E_{TOT_DRIFT}		-	± 2	-	%

[1] Typical values with \pm are 3 sigma values.

[2] Percentage of I_P , with $I_P = I_{PR(\text{max})}$.

[3] A single part will not have both the maximum/minimum sensitivity error and maximum/minimum offset voltage, as that would violate the maximum/minimum total output error specification. Also, 3 sigma distribution values are combined by taking the square root of the sum of the squares. See Application Information section.

[4] Voltage Offset Error does not incorporate any error due to external magnetic fields. See section: Impact of External Magnetic Fields.

xKMATR-20B PERFORMANCE CHARACTERISTICS: Valid at $T_A = -40^\circ\text{C}$ to 125°C , $V_{CC} = 5\text{ V}$, unless otherwise specified

Characteristic	Symbol	Test Conditions	Min.	Typ. [1]	Max.	Units
NOMINAL PERFORMANCE						
Current Sensing Range	I_{PR}		-20	-	20	A
Sensitivity	Sens	$I_{PR(\min)} < I_P < I_{PR(\max)}$	-	100	-	mV/A
Zero Current Output Voltage	$V_{IOUT(Q)}$	Bidirectional; $I_P = 0\text{ A}$	-	$V_{CC} \times 0.5$	-	V
ACCURACY PERFORMANCE						
Total Output Error [2]	E_{TOT}	$I_P = I_{PR(\max)}$; $T_A = 25^\circ\text{C}$	-5	± 2	5	%
		$I_P = I_{PR(\max)}$; $T_A = 85^\circ\text{C}$	-	1 ± 2	-	%
		$I_P = I_{PR(\max)}$; $T_A = 125^\circ\text{C}$	-	2 ± 3	-	%
		$I_P = I_{PR(\max)}$; $T_A = -40^\circ\text{C}$	-	± 3	-	%
TOTAL OUTPUT ERROR COMPONENTS [3] $E_{TOT} = E_{SENS} + 100 \times V_{OE} / (\text{Sens} \times I_P)$						
Sensitivity Error	E_{SENS}	$T_A = 25^\circ\text{C}$; measured at $I_P = I_{PR(\max)}$	-4	± 2	4	%
		$T_A = 85^\circ\text{C}$; measured at $I_P = I_{PR(\max)}$	-	1 ± 2	-	%
		$T_A = 125^\circ\text{C}$; measured at $I_P = I_{PR(\max)}$	-	2 ± 3	-	%
		$T_A = -40^\circ\text{C}$; measured at $I_P = I_{PR(\max)}$	-	± 3	-	%
Voltage Offset Error [4]	V_{OE}	$T_A = 25^\circ\text{C}$; $I_P = 0\text{ A}$;	-40	± 8	40	mV
		$T_A = 85^\circ\text{C}$; $I_P = 0\text{ A}$;	-	± 10	-	mV
		$T_A = 125^\circ\text{C}$; $I_P = 0\text{ A}$;	-	± 15	-	mV
		$T_A = -40^\circ\text{C}$; $I_P = 0\text{ A}$	-	± 15	-	mV
LIFETIME DRIFT CHARACTERISTICS						
Sensitivity Error Lifetime Drift	E_{SENS_DRIFT}		-	± 2	-	%
Total Output Error Lifetime Drift	E_{TOT_DRIFT}		-	± 2	-	%

[1] Typical values with \pm are 3 sigma values.

[2] Percentage of I_P , with $I_P = I_{PR(\max)}$.

[3] A single part will not have both the maximum/minimum sensitivity error and maximum/minimum offset voltage, as that would violate the maximum/minimum total output error specification. Also, 3 sigma distribution values are combined by taking the square root of the sum of the squares. See Application Information section.

[4] Voltage Offset Error does not incorporate any error due to external magnetic fields. See section: Impact of External Magnetic Fields.

CHARACTERISTIC PERFORMANCE

xKMATR-10B Key Parameters

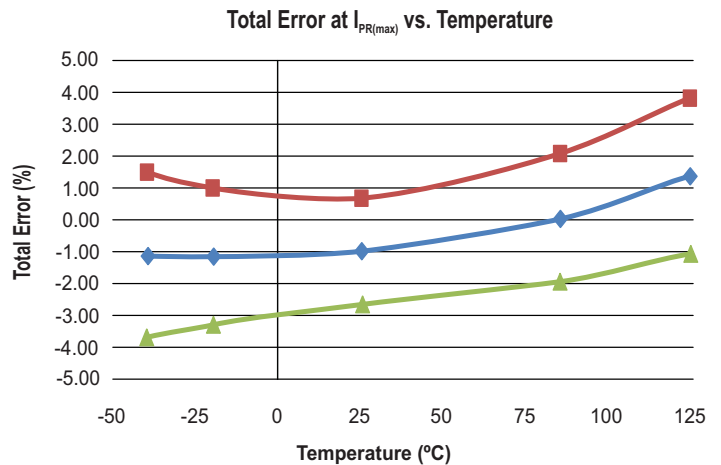
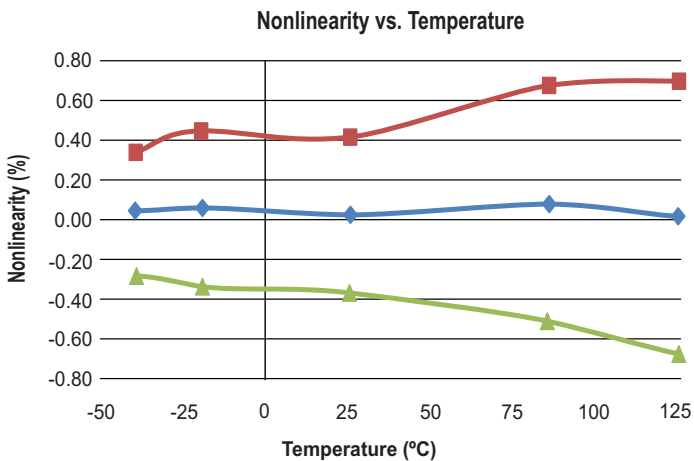
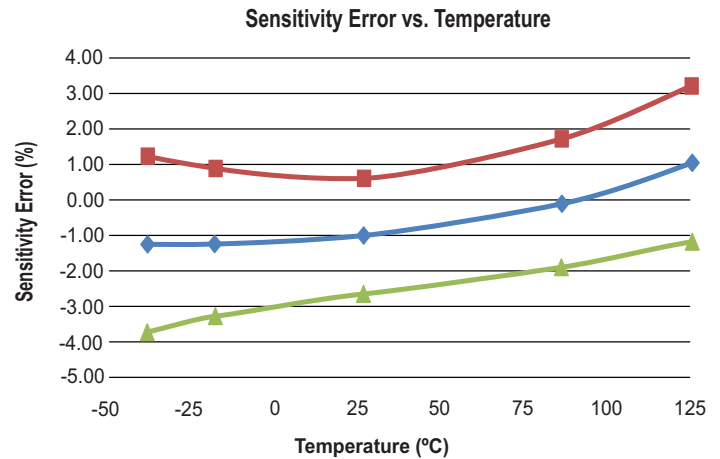
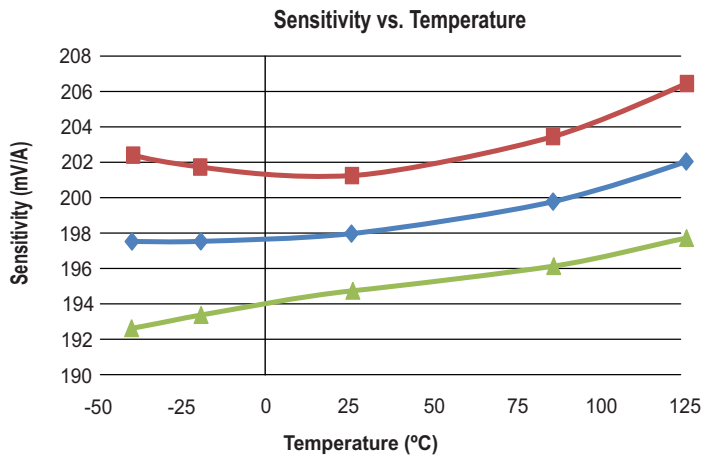
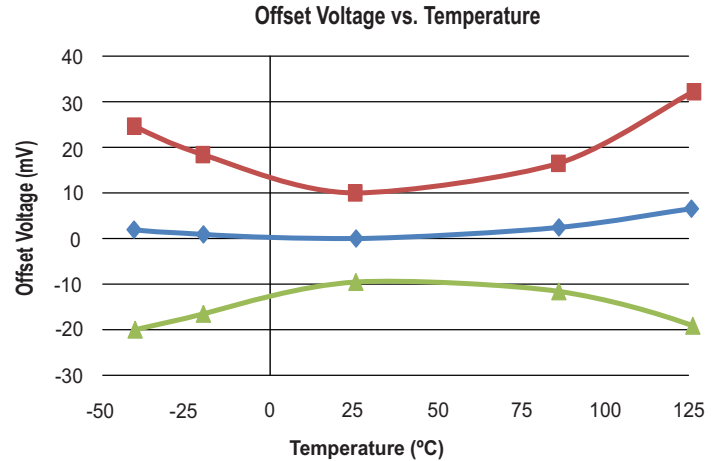
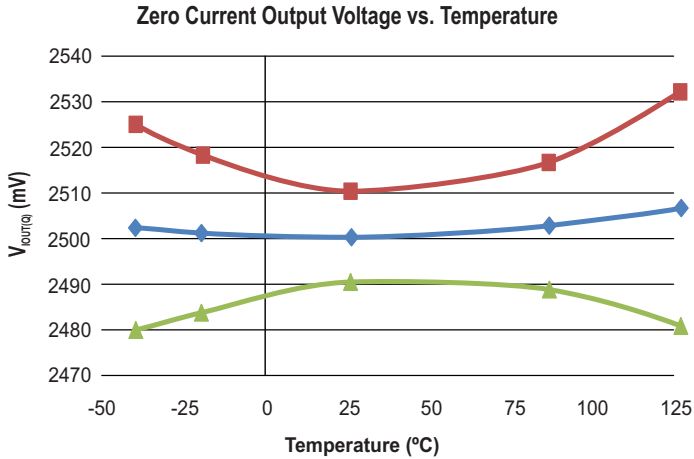

■ +3 Sigma
 ◆ Average
 ▲ -3 Sigma

xKMATR-20B Key Parameters

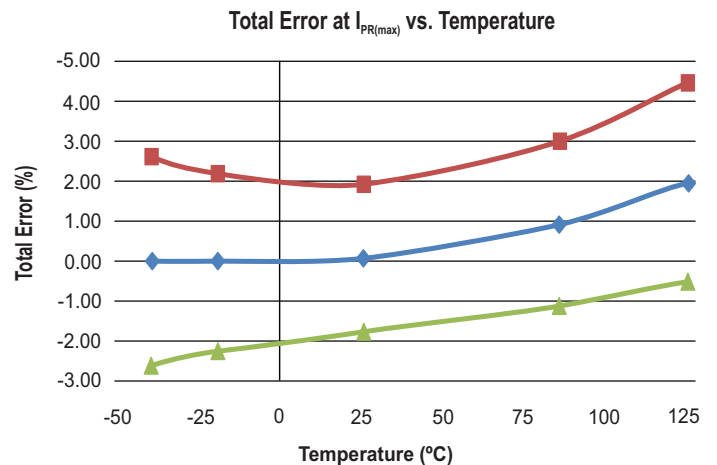
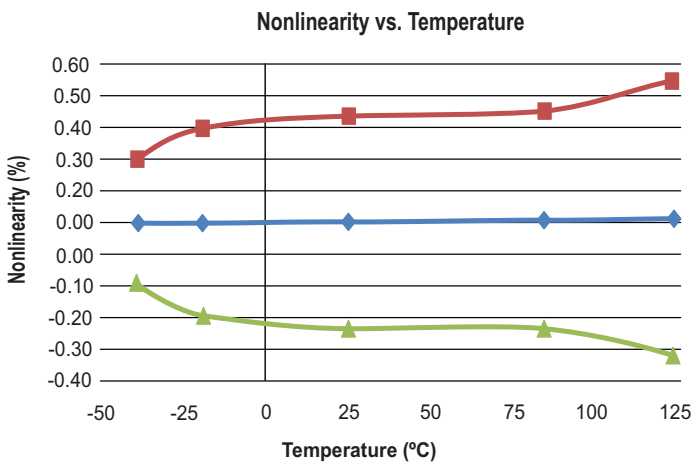
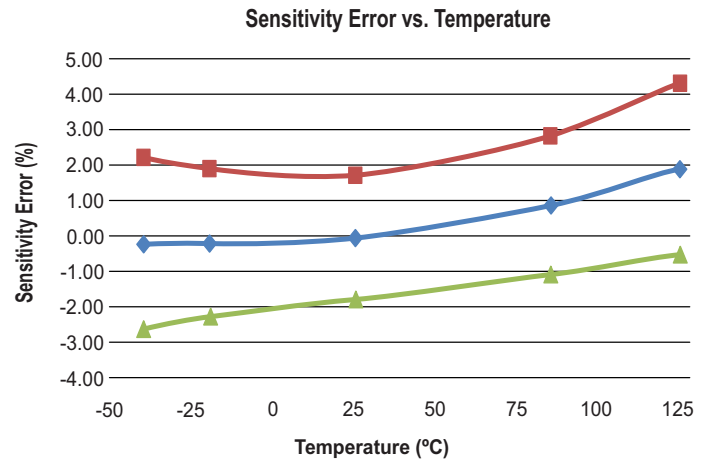
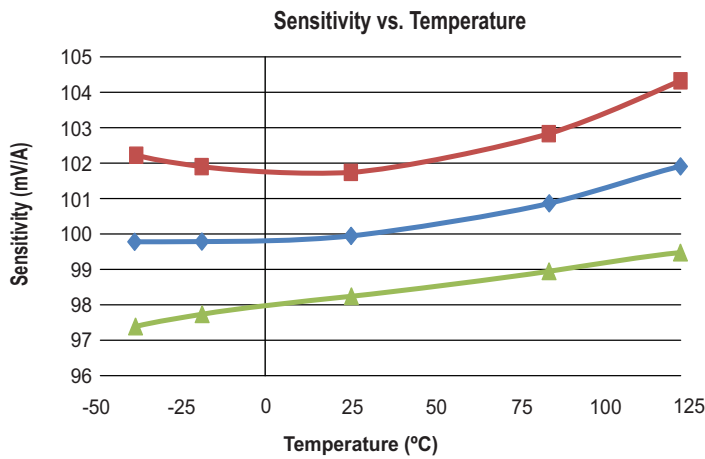
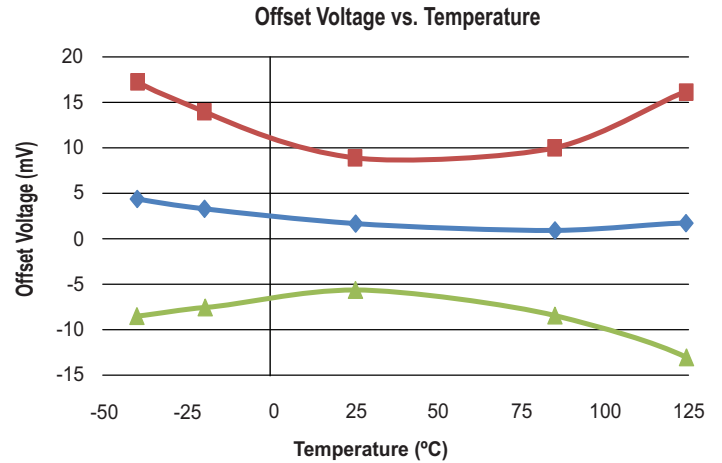
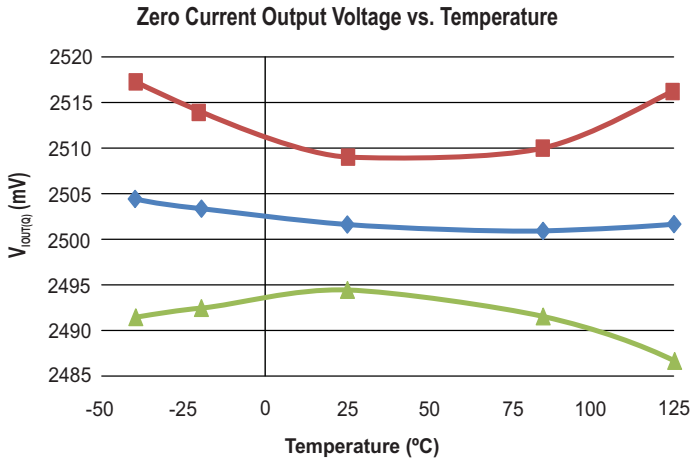

■ +3 Sigma
 ◆ Average
 ▲ -3 Sigma

CHARACTERISTIC PERFORMANCE ACS718 TYPICAL FREQUENCY RESPONSE

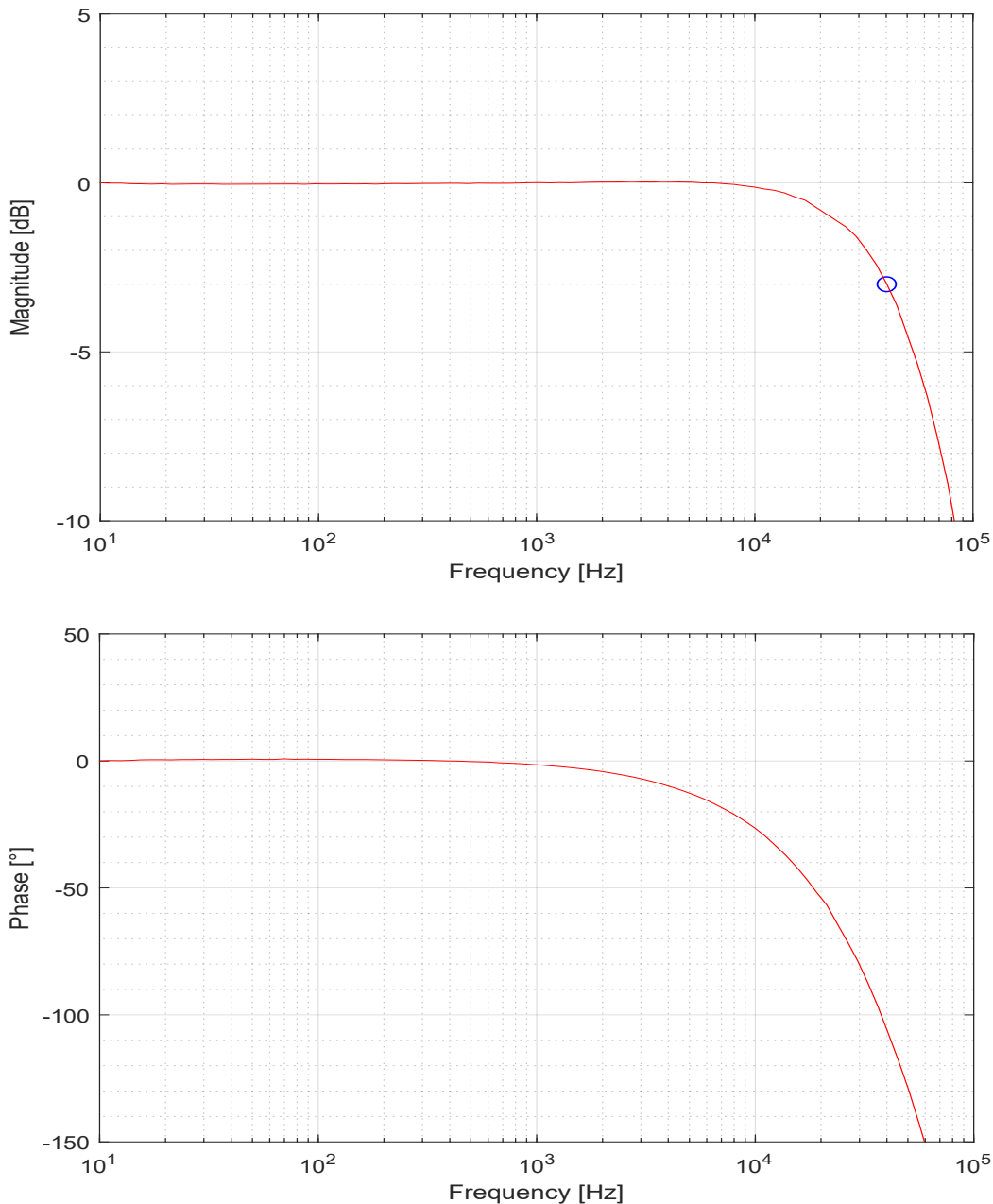

For information regarding bandwidth characterization methods used for the ACS718, see the “Characterizing System Bandwidth” application note (<https://allegromicro.com/en/insights-and-innovations/technical-documents/hall-effect-sensor-ic-publications/an296169-ac720-bandwidth-testing>) on the Allegro website.

RESPONSE CHARACTERISTICS DEFINITIONS AND PERFORMANCE DATA

Response Time (t_{RESPONSE})

The time interval between a) when the sensed input current reaches 90% of its final value, and b) when the sensor output reaches 90% of its full-scale value.

Propagation Delay (t_{pd})

The time interval between a) when the sensed input current reaches 20% of its full-scale value, and b) when the sensor output reaches 20% of its full-scale value.

Rise Time (t_r)

The time interval between a) when the sensor reaches 10% of its full-scale value, and b) when it reaches 90% of its full-scale value.

Output Slew Rate (SR)

The rate of change [$\text{V}/\mu\text{s}$] in the output voltage from a) when the sensor reaches 10% of its full-scale value, and b) when it reaches 90% of its full-scale value.

Response Time, Propagation Delay, Rise Time, and Output Slew Rate

Applied current step with 10%-90% rise time = 0.3 μs

Test Conditions: $T_A = 25^\circ\text{C}$, $C_{\text{BYPASS}} = 0.1 \mu\text{F}$, $C_L = 0 \text{F}$

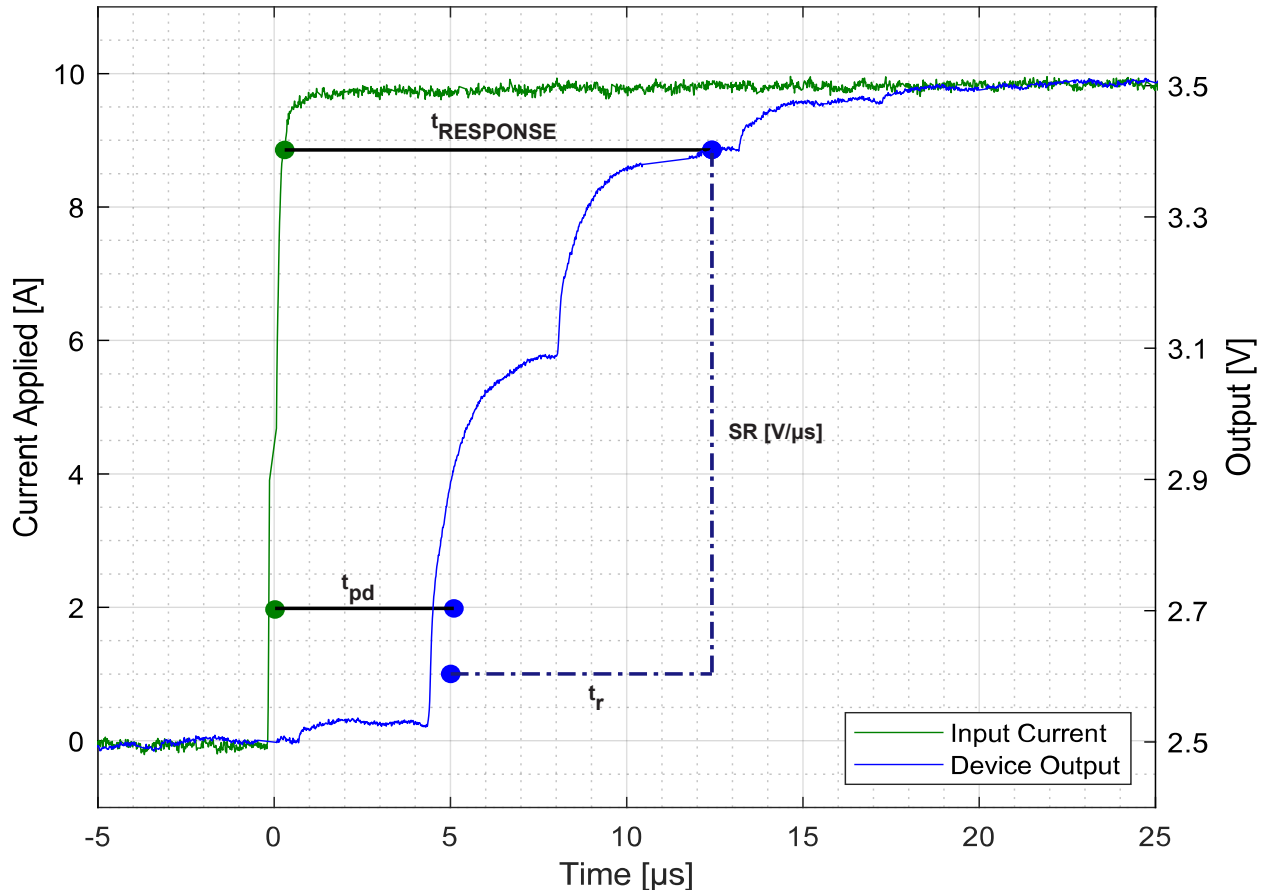

POWER ON FUNCTIONAL DESCRIPTION AND PERFORMANCE DATA

Power-On Time (t_{pO})

When the supply is ramped to its operating voltage, the device requires a finite amount of time to power its internal components before responding to an input magnetic field. Power-On Time (t_{pO}) is defined as the time interval between a) the power supply has reached its minimum specified operating voltage ($V_{CC(min)}$), and b) when the sensor output has settled within $\pm 10\%$ of its steady-state value under an applied magnetic field.

Power-On Profile

After applying power, the part remains off in a known state referred to as Power-on Reset, or POR. The device stays in this state until the voltage reaches a point at which the device will remain powered. The power-on profile below illustrates the intended power on/off. A pull-down resistor was used on the output of the tested device.

Power-On Time (t_{pO})

Test Conditions: $T_A = 25^\circ\text{C}$, $C_{BYPASS} = 0.1 \mu\text{F}$, $R_{PD} = 10 \text{ k}\Omega$

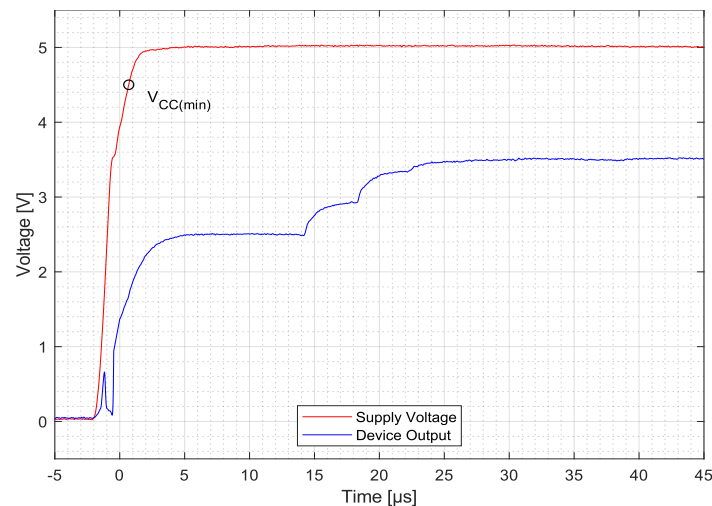

Power-On Profile

Supply voltage ramp rate = 1V/ms

Test Conditions: $T_A = 25^\circ\text{C}$, $C_{BYPASS} = 0.1 \mu\text{F}$, $R_{PD} = 10 \text{ k}\Omega$

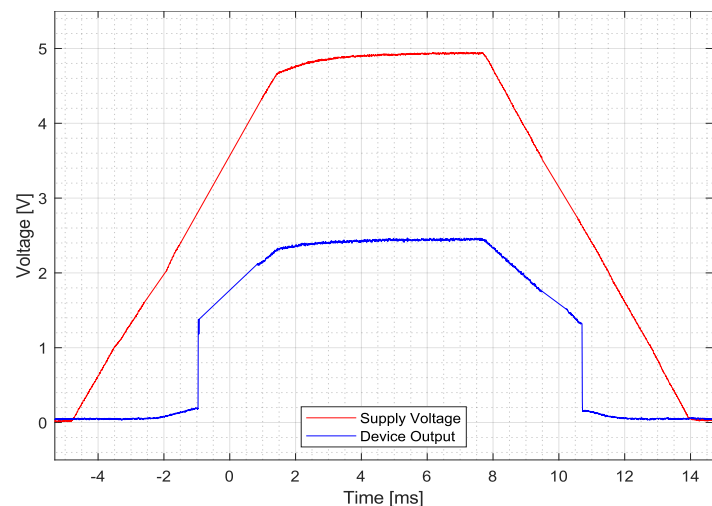

DEFINITIONS OF ACCURACY CHARACTERISTICS

Sensitivity (Sens). The change in sensor IC output in response to a 1 A change through the primary conductor. The sensitivity is the product of the magnetic circuit sensitivity (G/A) (1 G = 0.1 mT) and the linear IC amplifier gain (mV/G). The linear IC amplifier gain is programmed at the factory to optimize the sensitivity (mV/A) for the full-scale current of the device.

Nonlinearity (E_{LIN}). The nonlinearity is a measure of how linear the output of the sensor IC is over the full current measurement range. The nonlinearity is calculated as:

$$100 \left\{ 1 - \left[\frac{\Delta \text{gain} \times \% \text{ sat} (V_{IOUT_full\text{-scale amperes}} - V_{IOUT(Q)})}{2 (V_{IOUT_half\text{-scale amperes}} - V_{IOUT(Q)})} \right] \right\}$$

where $V_{IOUT}(I_{PR(max)})$ is the output of the sensor IC with the maximum measurement current flowing through it and $V_{IOUT}(I_{PR(max)}/2)$ is the output of the sensor IC with half of the maximum measurement current flowing through it.

Zero Current Output Voltage ($V_{IOUT(Q)}$). The output of the sensor when the primary current is zero. For a unipolar supply voltage, it nominally remains at $0.5 \times V_{CC}$ for a bidirectional device and $0.1 \times V_{CC}$ for a unidirectional device. For example, in the case of a bidirectional output device, $V_{CC} = 5 \text{ V}$ translates into $V_{IOUT(Q)} = 2.5 \text{ V}$. Variation in $V_{IOUT(Q)}$ can be attributed to the resolution of the Allegro linear IC quiescent voltage trim and thermal drift.

Voltage Offset Error (V_{OE}). The deviation of the device output from its ideal quiescent value of $0.5 \times V_{CC}$ (bidirectional) or $0.1 \times V_{CC}$ (unidirectional) due to nonmagnetic causes. To convert this voltage to amperes, divide by the device sensitivity, Sens.

Total Output Error (E_{TOT}). The difference between the current measurement from the sensor IC and the actual current (I_P), relative to the actual current. This is equivalent to the difference between the ideal output voltage and the actual output voltage, divided by the ideal sensitivity, relative to the current flowing through the primary conduction path:

$$E_{TOT}(I_P) = \frac{V_{IOUT_ideal}(I_P) - V_{IOUT}(I_P)}{\text{Sens}_{ideal}(I_P) \times I_P} \times 100 (\%)$$

The Total Output Error incorporates all sources of error and is a function of I_P . At relatively high currents, E_{TOT} will be mostly due to sensitivity error, and at relatively low currents, E_{TOT} will be mostly due to Voltage Offset Error (V_{OE}). In fact, at $I_P = 0$, E_{TOT} approaches infinity due to the offset. This is illustrated in figures 1 and 2. Figure 1 shows a distribution of output voltages versus I_P at 25°C and across temperature. Figure 2 shows the corresponding E_{TOT} versus I_P .

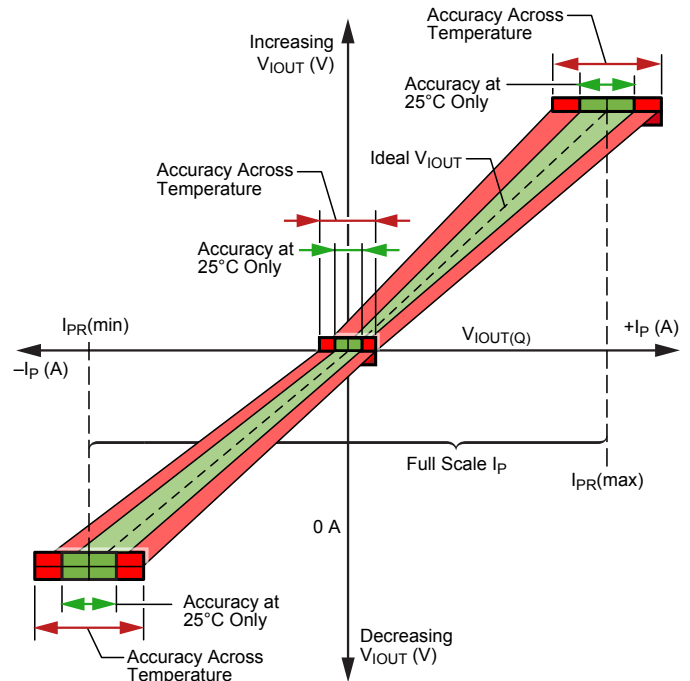

Figure 1: Output Voltage versus Sensed Current

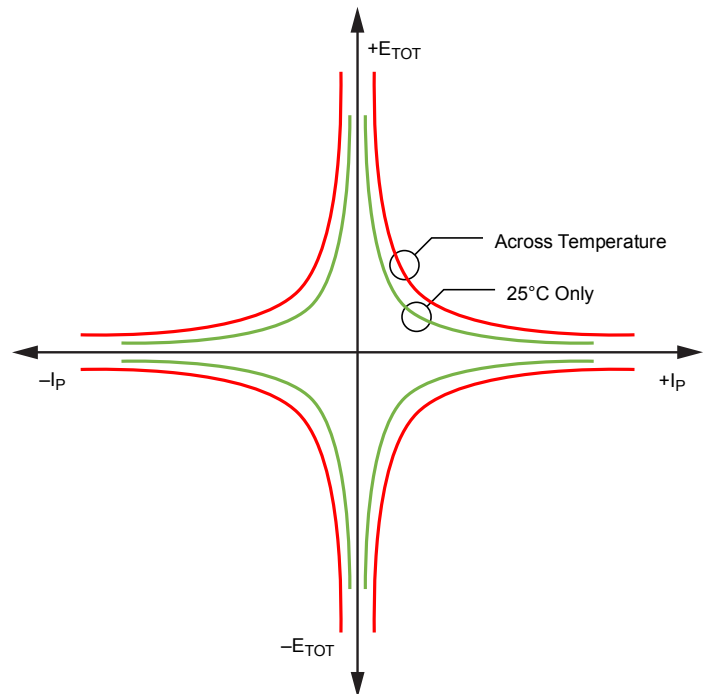

Figure 2: Total Output Error versus Sensed Current

APPLICATION INFORMATION

Impact of External Magnetic Fields

The ACS718 works by sensing the magnetic field created by the current flowing through the package. However, the sensor cannot differentiate between fields created by the current flow and external magnetic fields. This means that external magnetic fields can cause errors in the output of the sensor. Magnetic fields which are perpendicular to the surface of the package affect the output of the sensor, as it only senses fields in that one plane. The error in Amperes can be quantified as:

$$\text{Error}(B) = \frac{B}{C_F}$$

where B is the strength of the external field perpendicular to the surface of the package in Gauss, and C_F is the coupling factor in G/A. Then, multiplying by the sensitivity of the part (Sens) gives the error in mV.

For example, an external field of 1 Gauss will result in around 0.22 A of error. If the ACS718KMATR-10B, which has a nominal sensitivity of 200 mV/A, is being used, that equates to 44 mV of error on the output of the sensor.

Table 1: External Magnetic Field (Gauss) Impact

External Field (Gauss)	Error (A)	Error (mV)	
		10B	20B
0.5	0.11	22	11
1	0.22	44	22
2	0.44	88	44

Estimating Total Error vs. Sensed Current

The Performance Characteristics tables give distribution (± 3 sigma) values for Total Error at $I_{PR(max)}$; however, one often wants to know what error to expect at a particular current. This can be estimated by using the distribution data for the components of Total Error, Sensitivity Error, and Voltage Offset Error.

The ± 3 sigma value for Total Error (E_{TOT}) as a function of the sensed current (I_p) is estimated as:

$$E_{TOT}(I_p) = \sqrt{E_{SENS}^2 + \left(\frac{100 \times V_{OE}}{Sens \times I_p}\right)^2}$$

Here, E_{SENS} and V_{OE} are the ± 3 sigma values for those error terms. If there is an average sensitivity error or average offset voltage, then the average Total Error is estimated as:

$$E_{TOT,AVG}(I_p) = E_{SENS,AVG} + \frac{100 \times V_{OE,AVG}}{Sens \times I_p}$$

The resulting total error will be a sum of E_{TOT} and $E_{TOT,AVG}$. Using these equations and the 3 sigma distributions for Sensitivity Error and Voltage Offset Error, the Total Error vs. sensed current (I_p) is below for the ACS718KMATR-20B. As expected, as one goes towards zero current, the error in percent goes towards infinity due to division by zero (refer to Figure 3).

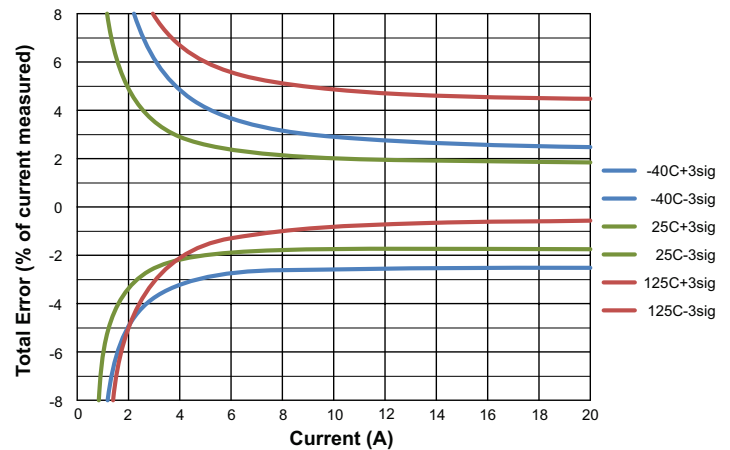

Figure 3: Predicted Total Error as a Function of Sensed Current for the ACS718KMATR-20B

Thermal Rise vs. Primary Current

Self-heating due to the flow of current should be considered during the design of any current sensing system. The sensor, printed circuit board (PCB), and contacts to the PCB will generate heat as current moves through the system.

The thermal response is highly dependent on PCB layout, copper thickness, cooling techniques, and the profile of the injected current. The current profile includes peak current, current “on-time”, and duty cycle. While the data presented in this section was collected with Direct-Current (DC), these numbers may be used to approximate thermal response for both AC signals and current pulses.

The plot in Figure 4 shows the measured rise in steady-state die temperature of the ACS718 versus continuous current at an ambient temperature, T_A , of 25 °C. The thermal offset curves may be directly applied to other values of T_A . Conversely, Figure 5 shows the maximum continuous current at a given T_A . Surges beyond the maximum current listed in Figure 5 are allowed given the maximum junction temperature, $T_{J(MAX)}$ (165°C), is not exceeded.

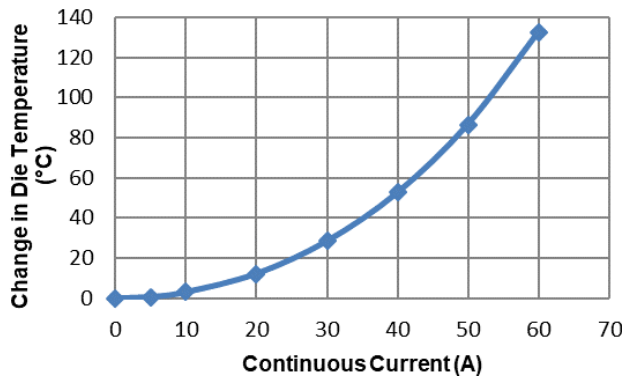

Figure 4: Self-Heating in the MA Package Due to Current Flow

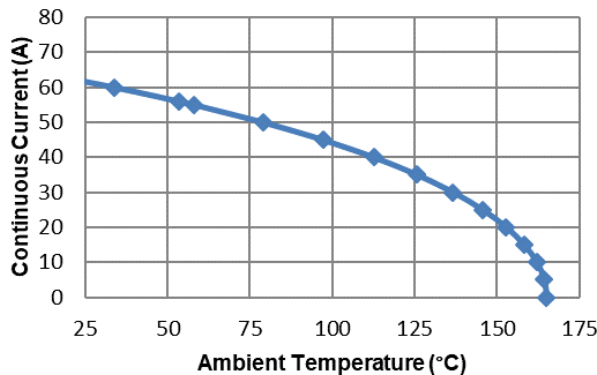

Figure 5: Maximum continuous current at a given T_A

The thermal capacity of the ACS718 should be verified by the end user in the application’s specific conditions. The maximum junction temperature, $T_{J(MAX)}$ (165°C), should not be exceeded. Further information on this application testing is available in the [DC and Transient Current Capability](#) application note on the Allegro website.

ASEK718 Evaluation Board Layout

Thermal data shown in Figure 4 and Figure 5 was collected using the ASEK718 Evaluation Board (TED-85-0667-002). This board includes 1500 mm² of 4 oz. copper (0.1388 mm) connected to pins 1 through 4, and to pins 5 through 8, with thermal vias connecting the layers. Top and Bottom layers of the PCB are shown below in Figure 6.

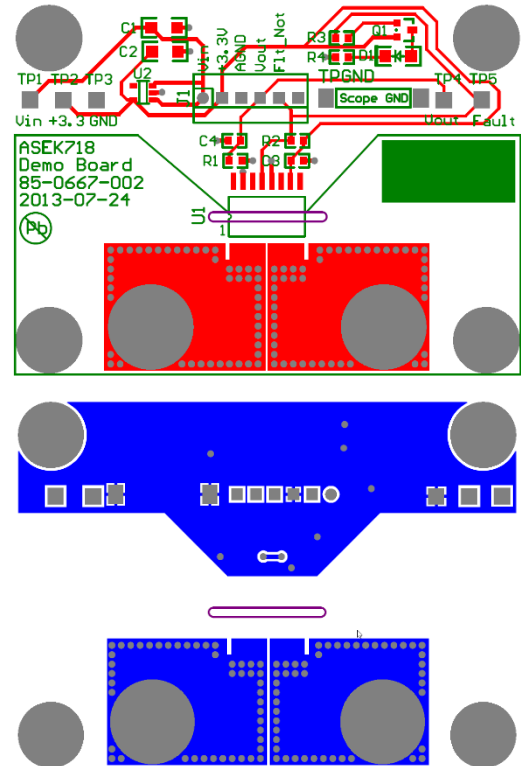
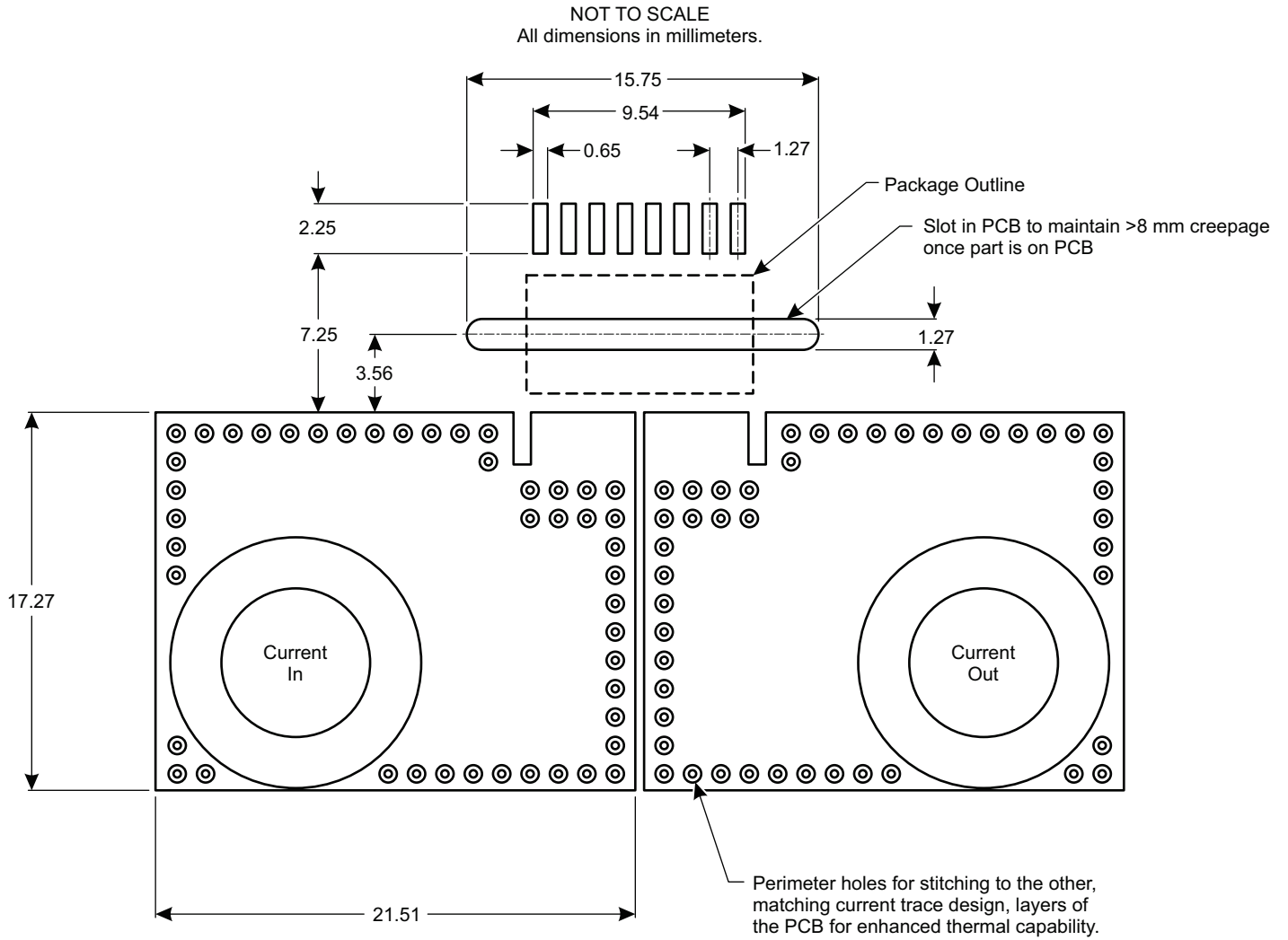

Figure 6: Top and Bottom Layers for ASEK718 Evaluation Board

Gerber files for the ASEK718 evaluation board are available for download from the Allegro website. Please see the technical documents section of the [ACS718](#) device webpage.

HIGH ISOLATION PCB LAYOUT



PACKAGE OUTLINE DRAWING

For Reference Only – Not for Tooling Use

(Reference Allegro DWG-0000388, Rev. 1 and JEDEC MS-013AA)

NOT TO SCALE

Dimensions in millimeters

Dimensions exclusive of mold flash, gate burrs, and dambar protrusions
Exact case and lead configuration at supplier discretion within limits shown

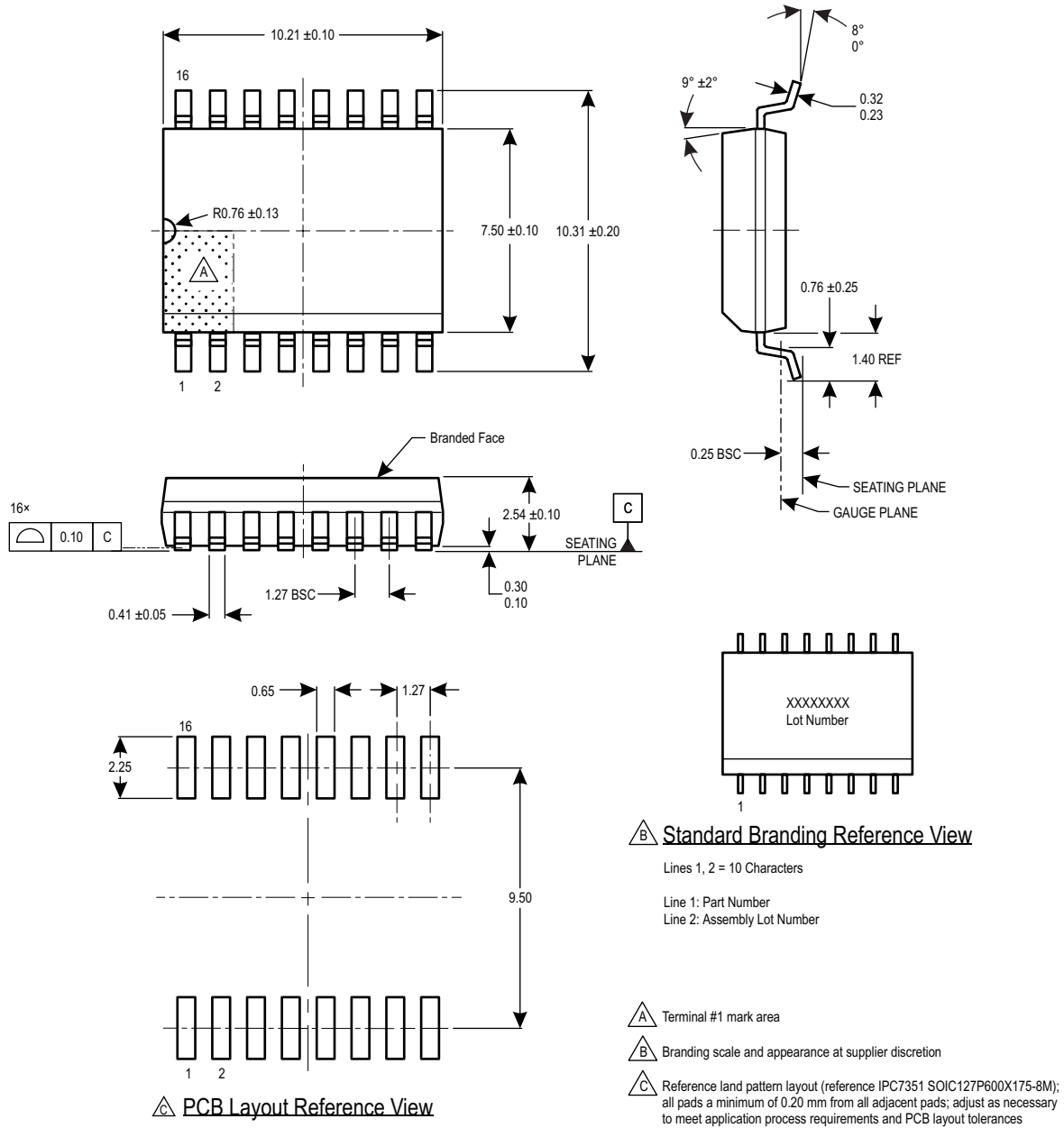

Figure 7: Package MA, 16-pin SOICW