

## High Accuracy, Hall-Effect-Based, 200 kHz Bandwidth, Galvanically Isolated Current Sensor IC with 100 $\mu\Omega$ Current Conductor

### FEATURES AND BENEFITS

- AEC-Q100 Grade 1 qualified
- Typical of 2.5  $\mu\text{s}$  output response time
- 5 V supply operation
- Ultra-low power loss: 100  $\mu\Omega$  internal conductor resistance
- Reinforced galvanic isolation allows use in economical, high-side current sensing in high-voltage systems
- 4800 Vrms dielectric strength certified under UL60950-1
- Industry-leading noise performance with greatly improved bandwidth through proprietary amplifier and filter design techniques
- Integrated shield greatly reduces capacitive coupling from current conductor to die due to high dV/dt signals, and prevents offset drift in high-side, high-voltage applications
- Greatly improved total output error through digitally programmed and compensated gain and offset over the full operating temperature range
- Small package size, with easy mounting capability
- Monolithic Hall IC for high reliability
- Output voltage proportional to AC or DC currents
- Factory-trimmed for accuracy
- Extremely stable output offset voltage

### DESCRIPTION

The Allegro™ ACS772 family of current sensor ICs provide economical and precise solutions for AC or DC current sensing, ideal for motor control, load detection and management, power supply and DC-to-DC converter control, and inverter control. The 2.5  $\mu\text{s}$  response time enables overcurrent fault detection in safety-critical applications.

The device consists of a precision, low-offset linear Hall circuit with a copper conduction path located near the die. Applied current flowing through this copper conduction path generates a magnetic field which the Hall IC converts into a proportional voltage. Device accuracy is optimized through the close proximity of the magnetic signal to the Hall transducer. A precise, proportional output voltage is provided by the low-offset, chopper-stabilized BiCMOS Hall IC, which is programmed for accuracy at the factory. Proprietary digital temperature compensation technology greatly improves the IC accuracy and temperature stability.

High-level immunity to current conductor dV/dt and stray electric fields is offered by Allegro proprietary integrated shield technology for low output voltage ripple and low offset drift in high-side, high-voltage applications.



*Continued on the next page...*

### PACKAGE: 5-pin package (suffix CB)

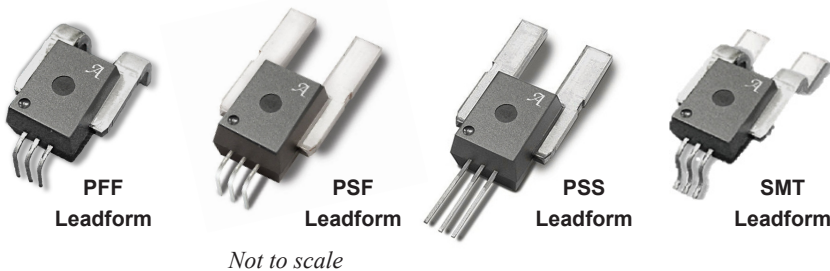

**Application 1:** the ACS772 outputs an analog signal,  $V_{\text{OUT}}$ , that varies linearly with the bidirectional AC or DC primary sensed current,  $I_{\text{P}}$ , within the range specified.  $R_{\text{F}}$  and  $C_{\text{F}}$  are for optimal noise management, with values that depend on the application.

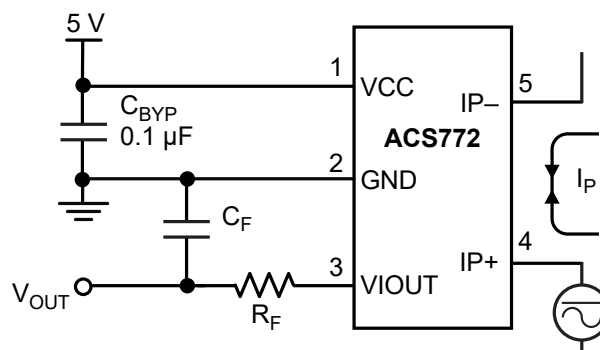

**Typical Application**

### DESCRIPTION (continued)

The output of the device increases when an increasing current flows through the primary copper conduction path (from terminal 4 to terminal 5), which is the path used for current sampling. The internal resistance of this conductive path is 100  $\mu\Omega$  typical, providing low power loss.

The thickness of the copper conductor allows survival of the device at high overcurrent conditions. The terminals of the conductive path are electrically isolated from the signal leads (pins 1 through 3). This

allows the ACS772 family of sensor ICs to be used in applications requiring electrical isolation without the use of opto-isolators or other costly isolation techniques.

The device is fully calibrated prior to shipment from the factory. The ACS772 family is lead (Pb) free. All leads are plated with 100% matte tin, and there is no Pb inside the package. The heavy gauge leadframe is made of oxygen-free copper.

# ACS772

## High Accuracy, Hall-Effect-Based, 200 kHz Bandwidth, Galvanically Isolated Current Sensor IC with 100 $\mu\Omega$ Current Conductor

### SELECTION GUIDE

Part Number [1]	Package		Primary Sampled Current , I <sub>p</sub> (A)	Sensitivity Sens (Typ.) (mV/A) [2]	Nominal T <sub>A</sub> [3] (°C)	Packing [4]
	Terminals	Signal Pins				
ACS772LCB-050U-PFF-T	Formed	Formed	50	80	-40 to 150	34 pieces per tube
ACS772LCB-050B-PFF-T	Formed	Formed	±50	40		
ACS772LCB-050B-PSF-T	Straight	Formed				
ACS772LCB-050B-PSS-T	Straight	Straight				
ACS772LCB-050B-SMT-T	Formed	Formed				
ACS772LCB-100U-PFF-T	Formed	Formed	100	40		
ACS772LCB-100B-PFF-T	Formed	Formed	±100	20		
ACS772LCB-100B-SMT-T	Formed	Formed				
ACS772KCB-150U-PFF-T	Formed	Formed	150	26.66	-40 to 125	
ACS772KCB-150U-SMT-T	Formed	Formed	±150	13.33		
ACS772KCB-150B-PFF-T	Formed	Formed				
ACS772KCB-150B-SMT-T	Formed	Formed				
ACS772ECB-200U-PFF-T	Formed	Formed	200	20	-40 to 85	
ACS772ECB-200B-PFF-T	Formed	Formed	±200	10		
ACS772ECB-200B-SMT-T	Formed	Formed				
ACS772ECB-250U-PFF-T	Formed	Formed	250	16		
ACS772ECB-250U-PSF-T	Straight	Formed	±250	8		
ACS772ECB-250B-PFF-T	Formed	Formed				
ACS772ECB-250B-PSF-T	Straight	Formed				
ACS772ECB-300B-PFF-T	Formed	Formed	±300	6.66		
ACS772ECB-400U-PSF-T	Straight	Formed	400	10		
ACS772ECB-400B-PFF-T	Formed	Formed	±400	5		

[1] Additional leadform and sensitivity options available for qualified volumes.

[2] Measured at V<sub>CC</sub> = 5 V.

[3] All ACS772 devices are production tested and guaranteed to T<sub>A</sub> = 150°C, provided the Maximum Junction Temperature, T<sub>J(MAX)</sub>, is not exceeded. See Absolute Maximum Ratings and Thermal Application section of this datasheet for more information.

[4] Contact Allegro for additional packing options.

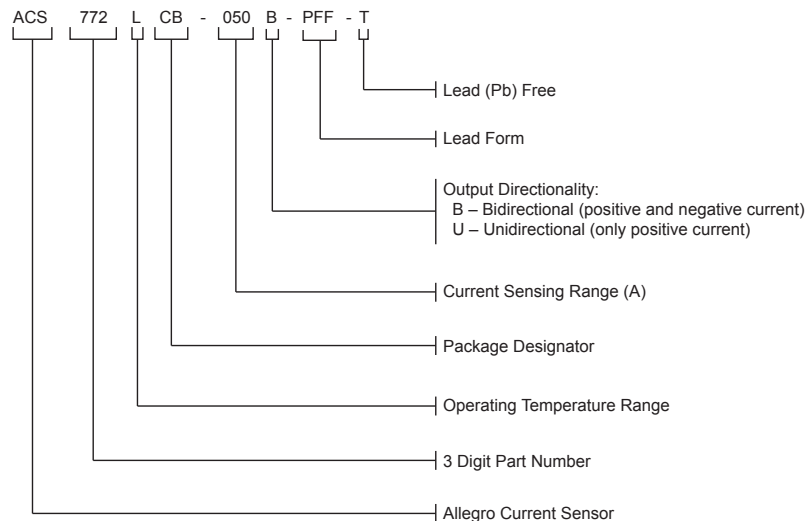

### ABSOLUTE MAXIMUM RATINGS

Characteristic	Symbol	Notes	Rating	Unit
Supply Voltage	$V_{CC}$		6.5	V
Reverse Supply Voltage	$V_{RCC}$		-0.5	V
Output Voltage	$V_{IOUT}$		6.5	V
Reverse Output Voltage	$V_{RIOUT}$		-0.5	V
Output Source Current	$I_{OUT(SOURCE)}$	V <sub>IOUT</sub> to GND	3	mA
Output Sink Current	$I_{OUT(SINK)}$	Minimum pull-up resistor of 500 $\Omega$ from V <sub>CC</sub> to V <sub>IOUT</sub>	10	mA
Maximum Continuous Current	$I_{CMAX}$	$T_A = 25^\circ\text{C}$	250	A
Operating Ambient Temperature [1]	$T_A$	Range E, K, and L	-40 to 150	$^\circ\text{C}$
Maximum Junction Temperature	$T_{J(max)}$		165	$^\circ\text{C}$
Storage Temperature	$T_{stg}$		-65 to 165	$^\circ\text{C}$

[1] All ACS772 devices are production tested and guaranteed to  $T_A = 150^\circ\text{C}$ , provided the Maximum Junction Temperature,  $T_{J(MAX)}$ , is not exceeded. See Thermal Application section of this datasheet for more information.

### ESD RATINGS

Characteristic	Symbol	Test Conditions	Value	Unit
Human Body Model	$V_{HBM}$	Per JEDEC JS-001	$\pm 6$	kV
Charged Device Model	$V_{CDM}$	Per JEDEC JS-002	$\pm 1$	kV

### ISOLATION CHARACTERISTICS

Characteristic	Symbol	Notes	Rating	Unit
Dielectric Surge Strength Test Voltage	$V_{SURGE}$	Tested $\pm 5$ pulses at 2/minute in compliance to IEC 61000-4-5 1.2 $\mu\text{s}$ (rise) / 50 $\mu\text{s}$ (width)	8000	V
Dielectric Strength Test Voltage [2]	$V_{ISO}$	Agency type-tested for 60 seconds per UL standard 60950-1, 2nd Edition. Tested at 3000 $V_{RMS}$ for 1 second in production.	4800	$V_{RMS}$
Working Voltage for Basic Isolation	$V_{WVBI}$	For basic (single) isolation per UL standard 60950-1, 2nd Edition	1358	$V_{PK}$ or $V_{DC}$
			960	$V_{RMS}$
Working Voltage for Reinforced Isolation	$V_{WFRI}$	For reinforced (double) isolation per UL standard 60950-1, 2nd Edition	672	$V_{PK}$ or $V_{DC}$
			475	$V_{RMS}$
Distance Through Insulation	DIT	Minimum internal distance through insulation	0.47	mm
Comparative Tracking Index	CTI	Material Group II	400 to 599	V

[2] Allegro does not conduct 60-second testing. It is done only during the UL certification process.

### TYPICAL OVERCURRENT CAPABILITIES [4][5]

Characteristic	Symbol	Notes	Rating	Unit
Overcurrent	$I_{POC}$	$T_A = 25^\circ\text{C}$ ; current is on for 1 second and off for 99 seconds, 100 pulses applied	1200	A
		$T_A = 85^\circ\text{C}$ ; current is on for 1 second and off for 99 seconds, 100 pulses applied	900	A
		$T_A = 150^\circ\text{C}$ ; current is on for 1 second and off for 99 seconds, 100 pulses applied	600	A

[4] Test was done with Allegro evaluation board. The maximum allowed current is limited by  $T_{J(max)}$  only.

[5] For more overcurrent profiles, please see FAQ on the Allegro website, [www.allegromicro.com](http://www.allegromicro.com).

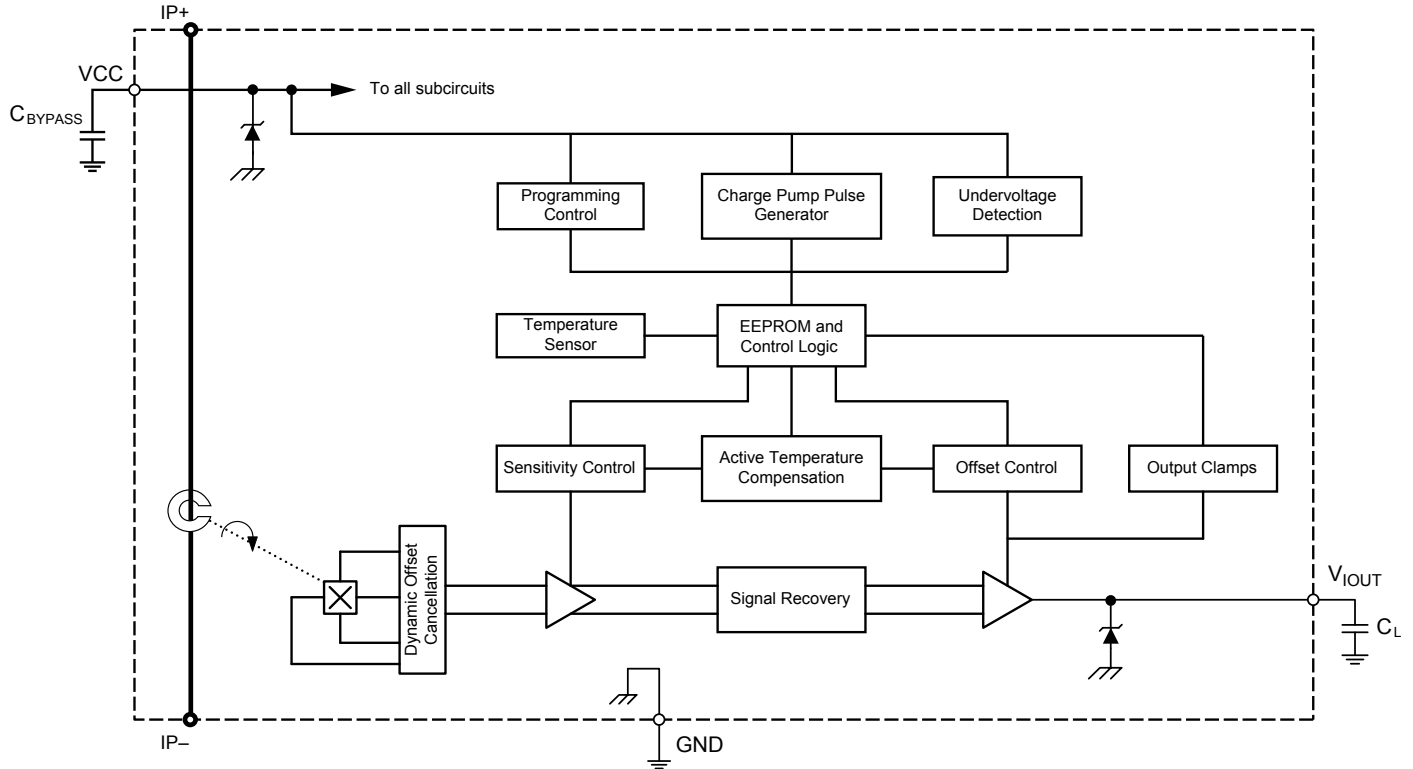

**Functional Block Diagram**

**THERMAL CHARACTERISTICS: May require derating at maximum conditions**

Characteristic	Symbol	Test Conditions [3]	Value	Unit
Package Thermal Resistance	$R_{\theta JA}$	Mounted on the Allegro evaluation board with 2800 mm <sup>2</sup> (1400 mm <sup>2</sup> on component side and 1400 mm <sup>2</sup> on opposite side) of 4 oz. copper connected to the primary leadframe and with thermal vias connecting the copper layers. Performance is based on current flowing through the primary leadframe and includes the power consumed by the PCB.	7	$^{\circ}\text{C}/\text{W}$

[3] Additional thermal information available on the Allegro website.

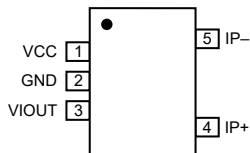

**Pinout Diagram**

**Terminal List Table**

Number	Name	Description
1	VCC	Device power supply terminal
2	GND	Signal ground terminal
3	V_IOUT	Analog output signal
4	IP+	Terminal for current being sampled
5	IP-	Terminal for current being sampled

**COMMON OPERATING CHARACTERISTICS:** Valid at  $T_A = -40^\circ\text{C}$  to  $150^\circ\text{C}$ ,  $C_{BYP} = 0.1 \mu\text{F}$ , and  $V_{CC} = 5 \text{ V}$ , unless otherwise specified

Characteristic	Symbol	Test Conditions	Min.	Typ.	Max.	Unit
<b>ELECTRICAL CHARACTERISTICS</b>						
Supply Voltage	$V_{CC}$		4.5	5	5.5	V
Supply Current	$I_{CC}$	$V_{CC} = 5 \text{ V}$ , no load on output	–	10	15	mA
Power-On Delay	$t_{POD}$	$T_A = 25^\circ\text{C}$	–	64	–	$\mu\text{s}$
Undervoltage Lockout (UVLO) Threshold <sup>[1]</sup>	$V_{UVLOH}$	$V_{CC}$ rising at 1 V/ms and device functions enabled	–	4	–	V
	$V_{UVLOL}$	$V_{CC}$ falling at 1 V/ms and device functions enabled	–	3.5	–	V
UVLO Hysteresis	$V_{HYS(UVLO)}$		250	–	–	mV
UVLO Enable/Disable Delay Time <sup>[1]</sup>	$t_{UVLOE}$	Time measured from falling $V_{CC} < V_{UVLOH}$ to UVLO enabled	–	64	–	$\mu\text{s}$
	$t_{UVLOD}$	Time measured from rising $V_{CC} > V_{UVLOH}$ to UVLO disabled	–	7	–	$\mu\text{s}$
Power-On Reset Voltage	$V_{PORH}$	$V_{CC}$ rising at 1 V/ms	–	2.9	–	V
	$V_{PORL}$	$V_{CC}$ falling at 1 V/ms	–	2.5	–	V
POR Hysteresis	$V_{HYS(POR)}$		250	–	–	mV
Rise Time	$t_r$	$T_A = 25^\circ\text{C}$ , $C_L = 0.47 \text{ nF}$	–	2.4	–	$\mu\text{s}$
Propagation Delay Time	$t_{PROP}$	$T_A = 25^\circ\text{C}$ , $C_L = 0.47 \text{ nF}$	–	1.2	–	$\mu\text{s}$
Response Time	$t_{RESPONSE}$	$T_A = 25^\circ\text{C}$ , $C_L = 0.47 \text{ nF}$	–	2.5	–	$\mu\text{s}$
Output Slew Rate	SR	$T_A = 25^\circ\text{C}$ , $C_L = 0.47 \text{ nF}$	–	0.67	–	V/ $\mu\text{s}$
Internal Bandwidth	$BW_i$	Small signal $-3 \text{ dB}$ , $C_L = 0.47 \text{ nF}$	–	200	–	kHz
DC Output Impedance	$R_{OUT}$	$T_A = 25^\circ\text{C}$	–	3.3	–	$\Omega$
Output Load Resistance	$R_{LOAD(MIN)}$	VIOUT to GND, VIOUT to VCC	4.7	–	–	k $\Omega$
Output Load Capacitance	$C_{LOAD(MAX)}$	VIOUT to GND	–	1	10	nF
Primary Conductor Resistance	$R_{PRIMARY}$	$T_A = 25^\circ\text{C}$	–	100	–	$\mu\Omega$
Output Saturation Voltage	$V_{SAT(HIGH)}$	$T_A = 25^\circ\text{C}$ , $R_{L(PULLDOWN)} = 10 \text{ k}\Omega$ to GND	$V_{CC} - 0.2$	–	–	V
	$V_{SAT(LOW)}$	$T_A = 25^\circ\text{C}$ , $R_{L(PULLUP)} = 10 \text{ k}\Omega$ to VCC	–	–	200	mV
<b>ERROR COMPONENTS</b>						
QVO Ratiometry Error <sup>[2]</sup>	$Rat_{ERRQVO}$	$V_{CC} = 4.75$ to $5.25 \text{ V}$	–	$\pm 0.15$	–	%
Sens Ratiometry Error <sup>[2]</sup>	$Rat_{ERRSens}$	$V_{CC} = 4.75$ to $5.25 \text{ V}$	–	$\pm 0.3$	–	%
Noise	$I_N$	Input referenced noise density; $T_A = 25^\circ\text{C}$ , $C_L = 1 \text{ nF}$	–	0.15	–	$\text{mA}/\sqrt{\text{Hz}}$
		Input referenced noise at 200 kHz; $T_A = 25^\circ\text{C}$ , $C_L = 1 \text{ nF}$	–	85	–	$\text{mA}_{RMS}$
Nonlinearity <sup>[2]</sup>	$E_{LIN}$	Up to 200 A	–0.9	$\pm 0.5$	0.9	%
Symmetry <sup>[2]</sup>	$E_{SYM}$	Over half-scale $I_p$	–0.8	$\pm 0.4$	0.8	%

<sup>[1]</sup> UVLO feature is only available on part numbers programmed to work at  $V_{CC} = 5 \text{ V}$ .

<sup>[2]</sup> See the Nonlinearity Characteristic Definitions section.

**X050U PERFORMANCE CHARACTERISTICS:  $T_A = -40^\circ\text{C}$  to  $150^\circ\text{C}$  [1],  $V_{CC} = 5\text{ V}$ , unless otherwise specified**

Characteristic	Symbol	Test Conditions	Min.	Typ. [2]	Max.	Unit
<b>NOMINAL PERFORMANCE</b>						
Current Sensing Range	$I_{PR}$		0	–	50	A
Sensitivity	Sens	$I_{PR(\min)} < I_P < I_{PR(\max)}$	–	$80 \times V_{CC} / 5$	–	mV/A
Zero Current Output Voltage	$V_{IOUT(Q)}$	Unidirectional; $I_P = 0\text{ A}$	–	$V_{CC} / 10$	–	V
<b>ACCURACY PERFORMANCE</b>						
Noise	$V_N$	$T_A = 25^\circ\text{C}$ , $C_L = 1\text{ nF}$	–	20.4	–	mV <sub>p-p</sub>
		$T_A = 25^\circ\text{C}$ , $C_L = 1\text{ nF}$	–	3.4	–	mV <sub>RMS</sub>
Sensitivity Error	$E_{Sens}$	Full scale of $I_P$ , $T_A = 25^\circ\text{C}$	–1	$\pm 0.7$	1	%
		Full scale of $I_P$ , $T_A = 25^\circ\text{C}$ to $150^\circ\text{C}$	–1.25	$\pm 0.8$	1.25	%
		Full scale of $I_P$ , $T_A = -40^\circ\text{C}$ to $25^\circ\text{C}$	–3.5	$\pm 1.7$	3.5	%
Electrical Offset Error	$V_{OE(TA)}$	$I_P = 0\text{ A}$ , $T_A = 25^\circ\text{C}$	–8	$\pm 4$	8	mV
	$V_{OE(TA)HT}$	$I_P = 0\text{ A}$ , $T_A = 25^\circ\text{C}$ to $150^\circ\text{C}$	–8	$\pm 4$	8	mV
	$V_{OE(TA)LT}$	$I_P = 0\text{ A}$ , $T_A = -40^\circ\text{C}$ to $25^\circ\text{C}$	–20	$\pm 6$	20	mV
Magnetic Offset Error	$I_{ERROM}$	$I_P = 0\text{ A}$ , $T_A = 25^\circ\text{C}$ , after excursion of $I_{PR(\max)}$	–	120	250	mA
Total Output Error	$E_{TOT(HT)}$	Full scale of $I_P$ , $T_A = 25^\circ\text{C}$ to $150^\circ\text{C}$	–1.5	$\pm 0.9$	1.5	%
	$E_{TOT(LT)}$	Full scale of $I_P$ , $T_A = -40^\circ\text{C}$ to $25^\circ\text{C}$	–3.5	$\pm 1.7$	3.5	%
<b>LIFETIME ACCURACY CHARACTERISTICS [3]</b>						
Sensitivity Error Including Lifetime	$E_{Sens(LIFE)(HT)}$	$T_A = 25^\circ\text{C}$ to $150^\circ\text{C}$	–2.1	$\pm 1.6$	2.1	%
	$E_{Sens(LIFE)(LT)}$	$T_A = -40^\circ\text{C}$ to $25^\circ\text{C}$	–3.5	$\pm 2.5$	3.5	%
Total Output Error Including Lifetime	$E_{TOT(LIFE)(HT)}$	$T_A = 25^\circ\text{C}$ to $150^\circ\text{C}$	–2.1	$\pm 1.7$	2.1	%
	$E_{TOT(LIFE)(LT)}$	$T_A = -40^\circ\text{C}$ to $25^\circ\text{C}$	–3.5	$\pm 2.6$	3.5	%
Electric Offset Error Including Lifetime	$E_{OFF(LIFE)(HT)}$	$T_A = 25^\circ\text{C}$ to $150^\circ\text{C}$	–10	$\pm 7$	10	mV
	$E_{OFF(LIFE)(LT)}$	$T_A = -40^\circ\text{C}$ to $25^\circ\text{C}$	–20	$\pm 8.9$	20	mV

[1] All ACS772 devices are production tested and guaranteed to  $T_A = 150^\circ\text{C}$ , provided the Maximum Junction Temperature,  $T_{J(\text{MAX})}$ , is not exceeded. See Absolute Maximum Ratings and Thermal Application section of this datasheet for more information.

[2] Typical values are  $\pm 3$  sigma values.

[3] Min/max limits are derived from AEC-Q100 Grade 1 testing.

**X050B PERFORMANCE CHARACTERISTICS:  $T_A = -40^\circ\text{C}$  to  $150^\circ\text{C}$  [1],  $V_{CC} = 5\text{ V}$ , unless otherwise specified**

Characteristic	Symbol	Test Conditions	Min.	Typ. [2]	Max.	Unit
<b>NOMINAL PERFORMANCE</b>						
Current Sensing Range	$I_{PR}$		-50	-	50	A
Sensitivity	Sens	$I_{PR(\min)} < I_P < I_{PR(\max)}$	-	$40 \times V_{CC} / 5$	-	mV/A
Zero Current Output Voltage	$V_{IOUT(Q)}$	Bidirectional; $I_P = 0\text{ A}$	-	$V_{CC} / 2$	-	V
<b>ACCURACY PERFORMANCE</b>						
Noise	$V_N$	$T_A = 25^\circ\text{C}$ , $C_L = 1\text{ nF}$	-	20.4	-	mV <sub>p-p</sub>
		$T_A = 25^\circ\text{C}$ , $C_L = 1\text{ nF}$	-	3.4	-	mV <sub>RMS</sub>
Sensitivity Error	$E_{Sens}$	Full scale of $I_P$ , $T_A = 25^\circ\text{C}$	-1	$\pm 0.7$	1	%
		Full scale of $I_P$ , $T_A = 25^\circ\text{C}$ to $150^\circ\text{C}$	-1.25	$\pm 0.8$	1.25	%
		Full scale of $I_P$ , $T_A = -40^\circ\text{C}$ to $25^\circ\text{C}$	-3.5	$\pm 1.7$	3.5	%
Electrical Offset Error	$V_{OE(TA)}$	$I_P = 0\text{ A}$ , $T_A = 25^\circ\text{C}$	-8	$\pm 4$	8	mV
	$V_{OE(TA)HT}$	$I_P = 0\text{ A}$ , $T_A = 25^\circ\text{C}$ to $150^\circ\text{C}$	-8	$\pm 4$	8	mV
	$V_{OE(TA)LT}$	$I_P = 0\text{ A}$ , $T_A = -40^\circ\text{C}$ to $25^\circ\text{C}$	-20	$\pm 6$	20	mV
Magnetic Offset Error	$I_{ERROM}$	$I_P = 0\text{ A}$ , $T_A = 25^\circ\text{C}$ , after excursion of $I_{PR(\max)}$	-	210	250	mA
Total Output Error	$E_{TOT(HT)}$	Full scale of $I_P$ , $T_A = 25^\circ\text{C}$ to $150^\circ\text{C}$	-1.5	$\pm 0.9$	1.5	%
	$E_{TOT(LT)}$	Full scale of $I_P$ , $T_A = -40^\circ\text{C}$ to $25^\circ\text{C}$	-3.5	$\pm 1.7$	3.5	%
<b>LIFETIME ACCURACY CHARACTERISTICS [3]</b>						
Sensitivity Error Including Lifetime	$E_{Sens(LIFE)(HT)}$	$T_A = 25^\circ\text{C}$ to $150^\circ\text{C}$	-2.1	$\pm 1.6$	2.1	%
	$E_{Sens(LIFE)(LT)}$	$T_A = -40^\circ\text{C}$ to $25^\circ\text{C}$	-3.5	$\pm 2.5$	3.5	%
Total Output Error Including Lifetime	$E_{TOT(LIFE)(HT)}$	$T_A = 25^\circ\text{C}$ to $150^\circ\text{C}$	-2.1	$\pm 1.7$	2.1	%
	$E_{TOT(LIFE)(LT)}$	$T_A = -40^\circ\text{C}$ to $25^\circ\text{C}$	-3.5	$\pm 2.6$	3.5	%
Electric Offset Error Including Lifetime	$E_{OFF(LIFE)(HT)}$	$T_A = 25^\circ\text{C}$ to $150^\circ\text{C}$	-10	$\pm 7$	10	mV
	$E_{OFF(LIFE)(LT)}$	$T_A = -40^\circ\text{C}$ to $25^\circ\text{C}$	-20	$\pm 8.9$	20	mV

[1] All ACS772 devices are production tested and guaranteed to  $T_A = 150^\circ\text{C}$ , provided the Maximum Junction Temperature,  $T_{J(\text{MAX})}$ , is not exceeded. See Absolute Maximum Ratings and Thermal Application section of this datasheet for more information.

[2] Typical values are  $\pm 3$  sigma values.

[3] Min/max limits are derived from AEC-Q100 Grade 1 testing.



**X100U PERFORMANCE CHARACTERISTICS:  $T_A = -40^\circ\text{C}$  to  $150^\circ\text{C}$  [1],  $V_{CC} = 5\text{ V}$ , unless otherwise specified**

Characteristic	Symbol	Test Conditions	Min.	Typ. [2]	Max.	Unit
<b>NOMINAL PERFORMANCE</b>						
Current Sensing Range	$I_{PR}$		0	–	100	A
Sensitivity	Sens	$I_{PR(\min)} < I_P < I_{PR(\max)}$	–	$40 \times V_{CC} / 5$	–	mV/A
Zero Current Output Voltage	$V_{IOUT(Q)}$	Unidirectional; $I_P = 0\text{ A}$	–	$V_{CC} / 10$	–	V
<b>ACCURACY PERFORMANCE</b>						
Noise	$V_N$	$T_A = 25^\circ\text{C}$ , $C_L = 1\text{ nF}$	–	20.4	–	mV <sub>p-p</sub>
		$T_A = 25^\circ\text{C}$ , $C_L = 1\text{ nF}$	–	3.4	–	mV <sub>RMS</sub>
Sensitivity Error	$E_{Sens}$	Full scale of $I_P$ , $T_A = 25^\circ\text{C}$	–1	$\pm 0.7$	1	%
		Full scale of $I_P$ , $T_A = 25^\circ\text{C}$ to $150^\circ\text{C}$	–1.25	$\pm 0.8$	1.25	%
		Full scale of $I_P$ , $T_A = -40^\circ\text{C}$ to $25^\circ\text{C}$	–3.5	$\pm 1.7$	3.5	%
Electrical Offset Error	$V_{OE(TA)}$	$I_P = 0\text{ A}$ , $T_A = 25^\circ\text{C}$	–8	$\pm 4$	8	mV
	$V_{OE(TA)HT}$	$I_P = 0\text{ A}$ , $T_A = 25^\circ\text{C}$ to $150^\circ\text{C}$	–8	$\pm 4$	8	mV
	$V_{OE(TA)LT}$	$I_P = 0\text{ A}$ , $T_A = -40^\circ\text{C}$ to $25^\circ\text{C}$	–20	$\pm 6$	20	mV
Magnetic Offset Error	$I_{ERROM}$	$I_P = 0\text{ A}$ , $T_A = 25^\circ\text{C}$ , after excursion of $I_{PR(\max)}$	–	280	400	mA
Total Output Error	$E_{TOT(HT)}$	Full scale of $I_P$ , $T_A = 25^\circ\text{C}$ to $150^\circ\text{C}$	–1.5	$\pm 0.9$	1.5	%
	$E_{TOT(LT)}$	Full scale of $I_P$ , $T_A = -40^\circ\text{C}$ to $25^\circ\text{C}$	–3.5	$\pm 1.7$	3.5	%
<b>LIFETIME ACCURACY CHARACTERISTICS [3]</b>						
Sensitivity Error Including Lifetime	$E_{Sens(LIFE)(HT)}$	$T_A = 25^\circ\text{C}$ to $150^\circ\text{C}$	–2.1	$\pm 1.6$	2.1	%
	$E_{Sens(LIFE)(LT)}$	$T_A = -40^\circ\text{C}$ to $25^\circ\text{C}$	–3.5	$\pm 2.5$	3.5	%
Total Output Error Including Lifetime	$E_{TOT(LIFE)(HT)}$	$T_A = 25^\circ\text{C}$ to $150^\circ\text{C}$	–2.1	$\pm 1.7$	2.1	%
	$E_{TOT(LIFE)(LT)}$	$T_A = -40^\circ\text{C}$ to $25^\circ\text{C}$	–3.5	$\pm 2.6$	3.5	%
Electric Offset Error Including Lifetime	$E_{OFF(LIFE)(HT)}$	$T_A = 25^\circ\text{C}$ to $150^\circ\text{C}$	–10	$\pm 7$	10	mV
	$E_{OFF(LIFE)(LT)}$	$T_A = -40^\circ\text{C}$ to $25^\circ\text{C}$	–20	$\pm 8.9$	20	mV

[1] All ACS772 devices are production tested and guaranteed to  $T_A = 150^\circ\text{C}$ , provided the Maximum Junction Temperature,  $T_{J(\text{MAX})}$ , is not exceeded. See Absolute Maximum Ratings and Thermal Application section of this datasheet for more information.

[2] Typical values are  $\pm 3$  sigma values.

[3] Min/max limits are derived from AEC-Q100 Grade 1 testing.

**X100B PERFORMANCE CHARACTERISTICS:  $T_A = -40^\circ\text{C}$  to  $150^\circ\text{C}$  [1],  $V_{CC} = 5\text{ V}$ , unless otherwise specified**

Characteristic	Symbol	Test Conditions	Min.	Typ. [2]	Max.	Unit
<b>NOMINAL PERFORMANCE</b>						
Current Sensing Range	$I_{PR}$		-100	-	100	A
Sensitivity	Sens	$I_{PR(\min)} < I_P < I_{PR(\max)}$	-	$20 \times V_{CC} / 5$	-	mV/A
Zero Current Output Voltage	$V_{IOUT(Q)}$	Bidirectional; $I_P = 0\text{ A}$	-	$V_{CC} / 2$	-	V
<b>ACCURACY PERFORMANCE</b>						
Noise	$V_N$	$T_A = 25^\circ\text{C}$ , $C_L = 1\text{ nF}$	-	20.4	-	mV <sub>p-p</sub>
		$T_A = 25^\circ\text{C}$ , $C_L = 1\text{ nF}$	-	3.4	-	mV <sub>RMS</sub>
Sensitivity Error	$E_{Sens}$	Full scale of $I_P$ , $T_A = 25^\circ\text{C}$	-1	$\pm 0.7$	1	%
		Full scale of $I_P$ , $T_A = 25^\circ\text{C}$ to $150^\circ\text{C}$	-1.25	$\pm 0.8$	1.25	%
		Full scale of $I_P$ , $T_A = -40^\circ\text{C}$ to $25^\circ\text{C}$	-3.5	$\pm 1.7$	3.5	%
Electrical Offset Error	$V_{OE(TA)}$	$I_P = 0\text{ A}$ , $T_A = 25^\circ\text{C}$	-8	$\pm 4$	8	mV
	$V_{OE(TA)HT}$	$I_P = 0\text{ A}$ , $T_A = 25^\circ\text{C}$ to $150^\circ\text{C}$	-8	$\pm 4$	8	mV
	$V_{OE(TA)LT}$	$I_P = 0\text{ A}$ , $T_A = -40^\circ\text{C}$ to $25^\circ\text{C}$	-20	$\pm 6$	20	mV
Magnetic Offset Error	$I_{ERROM}$	$I_P = 0\text{ A}$ , $T_A = 25^\circ\text{C}$ , after excursion of $I_{PR(\max)}$	-	175	400	mA
Total Output Error	$E_{TOT(HT)}$	Full scale of $I_P$ , $T_A = 25^\circ\text{C}$ to $150^\circ\text{C}$	-1.5	$\pm 0.9$	1.5	%
	$E_{TOT(LT)}$	Full scale of $I_P$ , $T_A = -40^\circ\text{C}$ to $25^\circ\text{C}$	-3.5	$\pm 1.7$	3.5	%
<b>LIFETIME ACCURACY CHARACTERISTICS [3]</b>						
Sensitivity Error Including Lifetime	$E_{Sens(LIFE)(HT)}$	$T_A = 25^\circ\text{C}$ to $150^\circ\text{C}$	-2.1	$\pm 1.6$	2.1	%
	$E_{Sens(LIFE)(LT)}$	$T_A = -40^\circ\text{C}$ to $25^\circ\text{C}$	-3.5	$\pm 2.5$	3.5	%
Total Output Error Including Lifetime	$E_{TOT(LIFE)(HT)}$	$T_A = 25^\circ\text{C}$ to $150^\circ\text{C}$	-2.1	$\pm 1.7$	2.1	%
	$E_{TOT(LIFE)(LT)}$	$T_A = -40^\circ\text{C}$ to $25^\circ\text{C}$	-3.5	$\pm 2.6$	3.5	%
Electric Offset Error Including Lifetime	$E_{OFF(LIFE)(HT)}$	$T_A = 25^\circ\text{C}$ to $150^\circ\text{C}$	-10	$\pm 7$	10	mV
	$E_{OFF(LIFE)(LT)}$	$T_A = -40^\circ\text{C}$ to $25^\circ\text{C}$	-20	$\pm 8.9$	20	mV

[1] All ACS772 devices are production tested and guaranteed to  $T_A = 150^\circ\text{C}$ , provided the Maximum Junction Temperature,  $T_{J(\text{MAX})}$ , is not exceeded. See Absolute Maximum Ratings and Thermal Application section of this datasheet for more information.

[2] Typical values are  $\pm 3$  sigma values.

[3] Min/max limits are derived from AEC-Q100 Grade 1 testing.

**X150U PERFORMANCE CHARACTERISTICS:  $T_A = -40^\circ\text{C}$  to  $150^\circ\text{C}$  [1],  $V_{CC} = 5\text{ V}$ , unless otherwise specified**

Characteristic	Symbol	Test Conditions	Min.	Typ. [2]	Max.	Unit
<b>NOMINAL PERFORMANCE</b>						
Current Sensing Range	$I_{PR}$		0	–	150	A
Sensitivity	Sens	$I_{PR(\min)} < I_P < I_{PR(\max)}$	–	$26.66 \times V_{CC} / 5$	–	mV/A
Zero Current Output Voltage	$V_{IOUT(Q)}$	Unidirectional; $I_P = 0\text{ A}$	–	$V_{CC} / 10$	–	V
<b>ACCURACY PERFORMANCE</b>						
Noise	$V_N$	$T_A = 25^\circ\text{C}$ , $C_L = 1\text{ nF}$	–	20.4	–	mV <sub>p-p</sub>
		$T_A = 25^\circ\text{C}$ , $C_L = 1\text{ nF}$	–	3.4	–	mV <sub>RMS</sub>
Sensitivity Error	$E_{Sens}$	Full scale of $I_P$ , $T_A = 25^\circ\text{C}$	–1	$\pm 0.7$	1	%
		Full scale of $I_P$ , $T_A = 25^\circ\text{C}$ to $150^\circ\text{C}$	–1.25	$\pm 0.8$	1.25	%
		Full scale of $I_P$ , $T_A = -40^\circ\text{C}$ to $25^\circ\text{C}$	–3.5	$\pm 1.7$	3.5	%
Electrical Offset Error	$V_{OE(TA)}$	$I_P = 0\text{ A}$ , $T_A = 25^\circ\text{C}$	–8	$\pm 4$	8	mV
	$V_{OE(TA)HT}$	$I_P = 0\text{ A}$ , $T_A = 25^\circ\text{C}$ to $150^\circ\text{C}$	–8	$\pm 4$	8	mV
	$V_{OE(TA)LT}$	$I_P = 0\text{ A}$ , $T_A = -40^\circ\text{C}$ to $25^\circ\text{C}$	–20	$\pm 6$	20	mV
Magnetic Offset Error	$I_{ERROM}$	$I_P = 0\text{ A}$ , $T_A = 25^\circ\text{C}$ , after excursion of $I_{PR(\max)}$	–	280	400	mA
Total Output Error	$E_{TOT(HT)}$	Full scale of $I_P$ , $T_A = 25^\circ\text{C}$ to $150^\circ\text{C}$	–1.5	$\pm 0.9$	1.5	%
	$E_{TOT(LT)}$	Full scale of $I_P$ , $T_A = -40^\circ\text{C}$ to $25^\circ\text{C}$	–3.5	$\pm 1.7$	3.5	%
<b>LIFETIME ACCURACY CHARACTERISTICS [3]</b>						
Sensitivity Error Including Lifetime	$E_{Sens(LIFE)(HT)}$	$T_A = 25^\circ\text{C}$ to $150^\circ\text{C}$	–2.1	$\pm 1.6$	2.1	%
	$E_{Sens(LIFE)(LT)}$	$T_A = -40^\circ\text{C}$ to $25^\circ\text{C}$	–3.5	$\pm 2.5$	3.5	%
Total Output Error Including Lifetime	$E_{TOT(LIFE)(HT)}$	$T_A = 25^\circ\text{C}$ to $150^\circ\text{C}$	–2.1	$\pm 1.7$	2.1	%
	$E_{TOT(LIFE)(LT)}$	$T_A = -40^\circ\text{C}$ to $25^\circ\text{C}$	–3.5	$\pm 2.6$	3.5	%
Electric Offset Error Including Lifetime	$E_{OFF(LIFE)(HT)}$	$T_A = 25^\circ\text{C}$ to $150^\circ\text{C}$	–10	$\pm 7$	10	mV
	$E_{OFF(LIFE)(LT)}$	$T_A = -40^\circ\text{C}$ to $25^\circ\text{C}$	–20	$\pm 8.9$	20	mV

[1] All ACS772 devices are production tested and guaranteed to  $T_A = 150^\circ\text{C}$ , provided the Maximum Junction Temperature,  $T_{J(\text{MAX})}$ , is not exceeded. See Absolute Maximum Ratings and Thermal Application section of this datasheet for more information.

[2] Typical values are  $\pm 3$  sigma values.

[3] Min/max limits are derived from AEC-Q100 Grade 1 testing.

**X150B PERFORMANCE CHARACTERISTICS:  $T_A = -40^\circ\text{C}$  to  $150^\circ\text{C}$  [1],  $V_{CC} = 5\text{ V}$ , unless otherwise specified**

Characteristic	Symbol	Test Conditions	Min.	Typ. [2]	Max.	Unit
<b>NOMINAL PERFORMANCE</b>						
Current Sensing Range	$I_{PR}$		-150	-	150	A
Sensitivity	Sens	$I_{PR(\min)} < I_P < I_{PR(\max)}$	-	$13.33 \times V_{CC} / 5$	-	mV/A
Zero Current Output Voltage	$V_{IOUT(Q)}$	Bidirectional; $I_P = 0\text{ A}$	-	$V_{CC} / 2$	-	V
<b>ACCURACY PERFORMANCE</b>						
Noise	$V_N$	$T_A = 25^\circ\text{C}$ , $C_L = 1\text{ nF}$	-	7.2	-	mV <sub>p-p</sub>
		$T_A = 25^\circ\text{C}$ , $C_L = 1\text{ nF}$	-	1.2	-	mV <sub>RMS</sub>
Sensitivity Error	$E_{\text{Sens}}$	Full scale of $I_P$ , $T_A = 25^\circ\text{C}$	-1	$\pm 0.7$	1	%
		Full scale of $I_P$ , $T_A = 25^\circ\text{C}$ to $150^\circ\text{C}$	-1.25	$\pm 0.8$	1.25	%
		Full scale of $I_P$ , $T_A = -40^\circ\text{C}$ to $25^\circ\text{C}$	-3.5	$\pm 1.7$	3.5	%
Electrical Offset Error	$V_{OE(TA)}$	$I_P = 0\text{ A}$ , $T_A = 25^\circ\text{C}$	-8	$\pm 4$	8	mV
	$V_{OE(TA)HT}$	$I_P = 0\text{ A}$ , $T_A = 25^\circ\text{C}$ to $150^\circ\text{C}$	-8	$\pm 4$	8	mV
	$V_{OE(TA)LT}$	$I_P = 0\text{ A}$ , $T_A = -40^\circ\text{C}$ to $25^\circ\text{C}$	-20	$\pm 6$	20	mV
Magnetic Offset Error	$I_{\text{ERROM}}$	$I_P = 0\text{ A}$ , $T_A = 25^\circ\text{C}$ , after excursion of $I_{PR(\max)}$	-	280	400	mA
Total Output Error	$E_{\text{TOT}(HT)}$	Full scale of $I_P$ , $T_A = 25^\circ\text{C}$ to $150^\circ\text{C}$	-1.5	$\pm 0.9$	1.5	%
	$E_{\text{TOT}(LT)}$	Full scale of $I_P$ , $T_A = -40^\circ\text{C}$ to $25^\circ\text{C}$	-3.5	$\pm 1.7$	3.5	%
<b>LIFETIME ACCURACY CHARACTERISTICS [3]</b>						
Sensitivity Error Including Lifetime	$E_{\text{Sens}(LIFE)(HT)}$	$T_A = 25^\circ\text{C}$ to $150^\circ\text{C}$	-2.1	$\pm 1.6$	2.1	%
	$E_{\text{Sens}(LIFE)(LT)}$	$T_A = -40^\circ\text{C}$ to $25^\circ\text{C}$	-3.5	$\pm 2.5$	3.5	%
Total Output Error Including Lifetime	$E_{\text{TOT}(LIFE)(HT)}$	$T_A = 25^\circ\text{C}$ to $150^\circ\text{C}$	-2.1	$\pm 1.7$	2.1	%
	$E_{\text{TOT}(LIFE)(LT)}$	$T_A = -40^\circ\text{C}$ to $25^\circ\text{C}$	-3.5	$\pm 2.6$	3.5	%
Electric Offset Error Including Lifetime	$E_{\text{OFF}(LIFE)(HT)}$	$T_A = 25^\circ\text{C}$ to $150^\circ\text{C}$	-10	$\pm 7$	10	mV
	$E_{\text{OFF}(LIFE)(LT)}$	$T_A = -40^\circ\text{C}$ to $25^\circ\text{C}$	-20	$\pm 8.9$	20	mV

[1] All ACS772 devices are production tested and guaranteed to  $T_A = 150^\circ\text{C}$ , provided the Maximum Junction Temperature,  $T_{J(\text{MAX})}$ , is not exceeded. See Absolute Maximum Ratings and Thermal Application section of this datasheet for more information.

[2] Typical values are  $\pm 3$  sigma values.

[3] Min/max limits are derived from AEC-Q100 Grade 1 testing.

**X200U PERFORMANCE CHARACTERISTICS:  $T_A = -40^\circ\text{C}$  to  $150^\circ\text{C}$  [1],  $V_{CC} = 5\text{ V}$ , unless otherwise specified**

Characteristic	Symbol	Test Conditions	Min.	Typ. [2]	Max.	Unit
<b>NOMINAL PERFORMANCE</b>						
Current Sensing Range	$I_{PR}$		0	–	200	A
Sensitivity	Sens	$I_{PR(\min)} < I_P < I_{PR(\max)}$	–	$20 \times V_{CC} / 5$	–	mV/A
Zero Current Output Voltage	$V_{IOUT(Q)}$	Unidirectional; $I_P = 0\text{ A}$	–	$V_{CC} / 10$	–	V
<b>ACCURACY PERFORMANCE</b>						
Noise	$V_N$	$T_A = 25^\circ\text{C}$ , $C_L = 1\text{ nF}$	–	7.2	–	mV <sub>p-p</sub>
		$T_A = 25^\circ\text{C}$ , $C_L = 1\text{ nF}$	–	1.2	–	mV <sub>RMS</sub>
Sensitivity Error	$E_{Sens}$	Full scale of $I_P$ , $T_A = 25^\circ\text{C}$	–1	$\pm 0.5$	1	%
		Full scale of $I_P$ , $T_A = 25^\circ\text{C}$ to $150^\circ\text{C}$	–1.25	$\pm 0.7$	1.25	%
		Full scale of $I_P$ , $T_A = -40^\circ\text{C}$ to $25^\circ\text{C}$	–3.5	$\pm 1.5$	3.5	%
Electrical Offset Error	$V_{OE(TA)}$	$I_P = 0\text{ A}$ , $T_A = 25^\circ\text{C}$	–8	$\pm 4$	8	mV
	$V_{OE(TA)HT}$	$I_P = 0\text{ A}$ , $T_A = 25^\circ\text{C}$ to $150^\circ\text{C}$	–8	$\pm 6$	8	mV
	$V_{OE(TA)LT}$	$I_P = 0\text{ A}$ , $T_A = -40^\circ\text{C}$ to $25^\circ\text{C}$	–20	$\pm 6$	20	mV
Magnetic Offset Error	$I_{ERROM}$	$I_P = 0\text{ A}$ , $T_A = 25^\circ\text{C}$ , after excursion of $I_{PR(\max)}$	–	160	400	mA
Total Output Error	$E_{TOT(HT)}$	Full scale of $I_P$ , $T_A = 25^\circ\text{C}$ to $150^\circ\text{C}$	–1.5	$\pm 0.9$	1.5	%
	$E_{TOT(LT)}$	Full scale of $I_P$ , $T_A = -40^\circ\text{C}$ to $25^\circ\text{C}$	–3.5	$\pm 1.7$	3.5	%
<b>LIFETIME ACCURACY CHARACTERISTICS [3]</b>						
Sensitivity Error Including Lifetime	$E_{Sens(LIFE)(HT)}$	$T_A = 25^\circ\text{C}$ to $150^\circ\text{C}$	–2.1	$\pm 1.6$	2.1	%
	$E_{Sens(LIFE)(LT)}$	$T_A = -40^\circ\text{C}$ to $25^\circ\text{C}$	–3.5	$\pm 2.5$	3.5	%
Total Output Error Including Lifetime	$E_{TOT(LIFE)(HT)}$	$T_A = 25^\circ\text{C}$ to $150^\circ\text{C}$	–2.1	$\pm 1.7$	2.1	%
	$E_{TOT(LIFE)(LT)}$	$T_A = -40^\circ\text{C}$ to $25^\circ\text{C}$	–3.5	$\pm 2.6$	3.5	%
Electric Offset Error Including Lifetime	$E_{OFF(LIFE)(HT)}$	$T_A = 25^\circ\text{C}$ to $150^\circ\text{C}$	–10	$\pm 7$	10	mV
	$E_{OFF(LIFE)(LT)}$	$T_A = -40^\circ\text{C}$ to $25^\circ\text{C}$	–20	$\pm 8.9$	20	mV

[1] All ACS772 devices are production tested and guaranteed to  $T_A = 150^\circ\text{C}$ , provided the Maximum Junction Temperature,  $T_{J(\text{MAX})}$ , is not exceeded. See Absolute Maximum Ratings and Thermal Application section of this datasheet for more information.

[2] Typical values are  $\pm 3$  sigma values.

[3] Min/max limits are derived from AEC-Q100 Grade 1 testing.

**X200B PERFORMANCE CHARACTERISTICS:  $T_A = -40^\circ\text{C}$  to  $150^\circ\text{C}$  [1],  $V_{CC} = 5\text{ V}$ , unless otherwise specified**

Characteristic	Symbol	Test Conditions	Min.	Typ. [2]	Max.	Unit
<b>NOMINAL PERFORMANCE</b>						
Current Sensing Range	$I_{PR}$		-200	-	200	A
Sensitivity	Sens	$I_{PR(\min)} < I_P < I_{PR(\max)}$	-	$10 \times V_{CC} / 5$	-	mV/A
Zero Current Output Voltage	$V_{IOUT(Q)}$	Bidirectional; $I_P = 0\text{ A}$	-	$V_{CC} / 2$	-	V
<b>ACCURACY PERFORMANCE</b>						
Noise	$V_N$	$T_A = 25^\circ\text{C}$ , $C_L = 1\text{ nF}$	-	5.1	-	mV <sub>p-p</sub>
		$T_A = 25^\circ\text{C}$ , $C_L = 1\text{ nF}$	-	0.85	-	mV <sub>RMS</sub>
Sensitivity Error	$E_{Sens}$	Full scale of $I_P$ , $T_A = 25^\circ\text{C}$	-1	$\pm 0.5$	1	%
		Full scale of $I_P$ , $T_A = 25^\circ\text{C}$ to $150^\circ\text{C}$	-1.25	$\pm 0.7$	1.25	%
		Full scale of $I_P$ , $T_A = -40^\circ\text{C}$ to $25^\circ\text{C}$	-3.5	$\pm 1.5$	3.5	%
Electrical Offset Error	$V_{OE(TA)}$	$I_P = 0\text{ A}$ , $T_A = 25^\circ\text{C}$	-8	$\pm 4$	8	mV
	$V_{OE(TA)HT}$	$I_P = 0\text{ A}$ , $T_A = 25^\circ\text{C}$ to $150^\circ\text{C}$	-8	$\pm 4$	8	mV
	$V_{OE(TA)LT}$	$I_P = 0\text{ A}$ , $T_A = -40^\circ\text{C}$ to $25^\circ\text{C}$	-20	$\pm 6$	20	mV
Magnetic Offset Error	$I_{ERROM}$	$I_P = 0\text{ A}$ , $T_A = 25^\circ\text{C}$ , after excursion of $I_{PR(\max)}$	-	380	400	mA
Total Output Error	$E_{TOT(HT)}$	Full scale of $I_P$ , $T_A = 25^\circ\text{C}$ to $150^\circ\text{C}$	-1.5	$\pm 0.7$	1.5	%
	$E_{TOT(LT)}$	Full scale of $I_P$ , $T_A = -40^\circ\text{C}$ to $25^\circ\text{C}$	-3.5	$\pm 1.5$	3.5	%
<b>LIFETIME ACCURACY CHARACTERISTICS [3]</b>						
Sensitivity Error Including Lifetime	$E_{Sens(LIFE)(HT)}$	$T_A = 25^\circ\text{C}$ to $150^\circ\text{C}$	-2.1	$\pm 1.6$	2.1	%
	$E_{Sens(LIFE)(LT)}$	$T_A = -40^\circ\text{C}$ to $25^\circ\text{C}$	-3.5	$\pm 2.5$	3.5	%
Total Output Error Including Lifetime	$E_{TOT(LIFE)(HT)}$	$T_A = 25^\circ\text{C}$ to $150^\circ\text{C}$	-2.1	$\pm 1.7$	2.1	%
	$E_{TOT(LIFE)(LT)}$	$T_A = -40^\circ\text{C}$ to $25^\circ\text{C}$	-3.5	$\pm 2.6$	3.5	%
Electric Offset Error Including Lifetime	$E_{OFF(LIFE)(HT)}$	$T_A = 25^\circ\text{C}$ to $150^\circ\text{C}$	-10	$\pm 7$	10	mV
	$E_{OFF(LIFE)(LT)}$	$T_A = -40^\circ\text{C}$ to $25^\circ\text{C}$	-20	$\pm 8.9$	20	mV

[1] All ACS772 devices are production tested and guaranteed to  $T_A = 150^\circ\text{C}$ , provided the Maximum Junction Temperature,  $T_{J(\text{MAX})}$ , is not exceeded. See Absolute Maximum Ratings and Thermal Application section of this datasheet for more information.

[2] Typical values are  $\pm 3$  sigma values.

[3] Min/max limits are derived from AEC-Q100 Grade 1 testing.

**X250U PERFORMANCE CHARACTERISTICS:  $T_A = -40^\circ\text{C}$  to  $150^\circ\text{C}$  [1],  $V_{CC} = 5\text{ V}$ , unless otherwise specified**

Characteristic	Symbol	Test Conditions	Min.	Typ. [2]	Max.	Unit
<b>NOMINAL PERFORMANCE</b>						
Current Sensing Range	$I_{PR}$		0	–	250	A
Sensitivity	Sens	$I_{PR(\min)} < I_P < I_{PR(\max)}$	–	$16 \times V_{CC} / 5$	–	mV/A
Zero Current Output Voltage	$V_{IOUT(Q)}$	Unidirectional; $I_P = 0\text{ A}$	–	$V_{CC} / 10$	–	V
<b>ACCURACY PERFORMANCE</b>						
Noise	$V_N$	$T_A = 25^\circ\text{C}$ , $C_L = 1\text{ nF}$	–	5.1	–	mV <sub>p-p</sub>
		$T_A = 25^\circ\text{C}$ , $C_L = 1\text{ nF}$	–	0.85	–	mV <sub>RMS</sub>
Sensitivity Error	$E_{Sens}$	$I_P = 200\text{ A}$ , not tested at full scale $I_P$ ; $T_A = 25^\circ\text{C}$	–1	$\pm 0.7$	1	%
		$I_P = 200\text{ A}$ , not tested at full scale $I_P$ ; $T_A = 25^\circ\text{C}$ to $150^\circ\text{C}$	–1.25	$\pm 0.8$	1.25	%
		$I_P = 200\text{ A}$ , not tested at full scale $I_P$ ; $T_A = -40^\circ\text{C}$ to $25^\circ\text{C}$	–3.5	$\pm 1.7$	3.5	%
Electrical Offset Error	$V_{OE(TA)}$	$I_P = 0\text{ A}$ , $T_A = 25^\circ\text{C}$	–8	$\pm 4$	8	mV
	$V_{OE(TA)HT}$	$I_P = 0\text{ A}$ , $T_A = 25^\circ\text{C}$ to $150^\circ\text{C}$	–8	$\pm 4$	8	mV
	$V_{OE(TA)LT}$	$I_P = 0\text{ A}$ , $T_A = -40^\circ\text{C}$ to $25^\circ\text{C}$	–20	$\pm 6$	20	mV
Magnetic Offset Error	$I_{ERROM}$	$I_P = 0\text{ A}$ , $T_A = 25^\circ\text{C}$ , after excursion of $I_{PR(\max)}$	–	200	400	mA
Total Output Error	$E_{TOT(HT)}$	$I_P = 200\text{ A}$ , not tested at full scale $I_P$ ; $T_A = 25^\circ\text{C}$ to $150^\circ\text{C}$	–1.5	$\pm 0.9$	1.5	%
	$E_{TOT(LT)}$	$I_P = 200\text{ A}$ , not tested at full scale $I_P$ ; $T_A = -40^\circ\text{C}$ to $25^\circ\text{C}$	–3.5	$\pm 1.7$	3.5	%
<b>LIFETIME ACCURACY CHARACTERISTICS [3]</b>						
Sensitivity Error Including Lifetime	$E_{Sens(LIFE)(HT)}$	$T_A = 25^\circ\text{C}$ to $150^\circ\text{C}$	–2.1	$\pm 1.6$	2.1	%
	$E_{Sens(LIFE)(LT)}$	$T_A = -40^\circ\text{C}$ to $25^\circ\text{C}$	–3.5	$\pm 2.5$	3.5	%
Total Output Error Including Lifetime	$E_{TOT(LIFE)(HT)}$	$T_A = 25^\circ\text{C}$ to $150^\circ\text{C}$	–2.1	$\pm 1.7$	2.1	%
	$E_{TOT(LIFE)(LT)}$	$T_A = -40^\circ\text{C}$ to $25^\circ\text{C}$	–3.5	$\pm 2.6$	3.5	%
Electric Offset Error Including Lifetime	$E_{OFF(LIFE)(HT)}$	$T_A = 25^\circ\text{C}$ to $150^\circ\text{C}$	–10	$\pm 7$	10	mV
	$E_{OFF(LIFE)(LT)}$	$T_A = -40^\circ\text{C}$ to $25^\circ\text{C}$	–20	$\pm 8.9$	20	mV

[1] All ACS772 devices are production tested and guaranteed to  $T_A = 150^\circ\text{C}$ , provided the Maximum Junction Temperature,  $T_{J(\max)}$ , is not exceeded. See Absolute Maximum Ratings and Thermal Application section of this datasheet for more information.

[2] Typical values are  $\pm 3$  sigma values.

[3] Min/max limits are derived from AEC-Q100 Grade 1 testing.

**X250B PERFORMANCE CHARACTERISTICS:  $T_A = -40^\circ\text{C}$  to  $150^\circ\text{C}$  [1],  $V_{CC} = 5\text{ V}$ , unless otherwise specified**

Characteristic	Symbol	Test Conditions	Min.	Typ. [2]	Max.	Unit
<b>NOMINAL PERFORMANCE</b>						
Current Sensing Range	$I_{PR}$		-250	-	250	A
Sensitivity	Sens	$I_{PR(\min)} < I_P < I_{PR(\max)}$	-	$\frac{8 \times V_{CC}}{5}$	-	mV/A
Zero Current Output Voltage	$V_{IOUT(Q)}$	Bidirectional; $I_P = 0\text{ A}$	-	$V_{CC} / 2$	-	V
<b>ACCURACY PERFORMANCE</b>						
Noise	$V_N$	$T_A = 25^\circ\text{C}$ , $C_L = 1\text{ nF}$	-	5.1	-	mV <sub>p-p</sub>
		$T_A = 25^\circ\text{C}$ , $C_L = 1\text{ nF}$	-	0.85	-	mV <sub>RMS</sub>
Sensitivity Error	$E_{Sens}$	$I_P = 200\text{ A}$ , not tested at full scale $I_P$ ; $T_A = 25^\circ\text{C}$	-1	$\pm 0.7$	1	%
		$I_P = 200\text{ A}$ , not tested at full scale $I_P$ ; $T_A = 25^\circ\text{C}$ to $150^\circ\text{C}$	-1.25	$\pm 0.8$	1.25	%
		$I_P = 200\text{ A}$ , not tested at full scale $I_P$ ; $T_A = -40^\circ\text{C}$ to $25^\circ\text{C}$	-3.5	$\pm 1.7$	3.5	%
Electrical Offset Error	$V_{OE(TA)}$	$I_P = 0\text{ A}$ , $T_A = 25^\circ\text{C}$	-8	$\pm 4$	8	mV
	$V_{OE(TA)HT}$	$I_P = 0\text{ A}$ , $T_A = 25^\circ\text{C}$ to $150^\circ\text{C}$	-8	$\pm 4$	8	mV
	$V_{OE(TA)LT}$	$I_P = 0\text{ A}$ , $T_A = -40^\circ\text{C}$ to $25^\circ\text{C}$	-20	$\pm 6$	20	mV
Magnetic Offset Error	$I_{ERROM}$	$I_P = 0\text{ A}$ , $T_A = 25^\circ\text{C}$ , after excursion of $I_{PR(\max)}$	-	175	400	mA
Total Output Error	$E_{TOT(HT)}$	$I_P = 200\text{ A}$ , not tested at full scale $I_P$ ; $T_A = 25^\circ\text{C}$ to $150^\circ\text{C}$	-1.5	$\pm 0.9$	1.5	%
	$E_{TOT(LT)}$	$I_P = 200\text{ A}$ , not tested at full scale $I_P$ ; $T_A = -40^\circ\text{C}$ to $25^\circ\text{C}$	-3.5	$\pm 1.7$	3.5	%
<b>LIFETIME ACCURACY CHARACTERISTICS [3]</b>						
Sensitivity Error Including Lifetime	$E_{Sens(LIFE)(HT)}$	$T_A = 25^\circ\text{C}$ to $150^\circ\text{C}$	-2.1	$\pm 1.6$	2.1	%
	$E_{Sens(LIFE)(LT)}$	$T_A = -40^\circ\text{C}$ to $25^\circ\text{C}$	-3.5	$\pm 2.5$	3.5	%
Total Output Error Including Lifetime	$E_{TOT(LIFE)(HT)}$	$T_A = 25^\circ\text{C}$ to $150^\circ\text{C}$	-2.1	$\pm 1.7$	2.1	%
	$E_{TOT(LIFE)(LT)}$	$T_A = -40^\circ\text{C}$ to $25^\circ\text{C}$	-3.5	$\pm 2.6$	3.5	%
Electric Offset Error Including Lifetime	$E_{OFF(LIFE)(HT)}$	$T_A = 25^\circ\text{C}$ to $150^\circ\text{C}$	-10	$\pm 7$	10	mV
	$E_{OFF(LIFE)(LT)}$	$T_A = -40^\circ\text{C}$ to $25^\circ\text{C}$	-20	$\pm 8.9$	20	mV

[1] All ACS772 devices are production tested and guaranteed to  $T_A = 150^\circ\text{C}$ , provided the Maximum Junction Temperature,  $T_{J(\text{MAX})}$ , is not exceeded. See Absolute Maximum Ratings and Thermal Application section of this datasheet for more information.

[2] Typical values are  $\pm 3$  sigma values.

[3] Min/max limits are derived from AEC-Q100 Grade 1 testing.



**X300B PERFORMANCE CHARACTERISTICS:  $T_A = -40^\circ\text{C}$  to  $150^\circ\text{C}$  [1],  $V_{CC} = 5\text{ V}$ , unless otherwise specified**

Characteristic	Symbol	Test Conditions	Min.	Typ. [2]	Max.	Unit
<b>NOMINAL PERFORMANCE</b>						
Current Sensing Range	$I_{PR}$		-300	-	300	A
Sensitivity	Sens	$I_{PR(\min)} < I_P < I_{PR(\max)}$	-	$6.66 \times V_{CC} / 5$	-	mV/A
Zero Current Output Voltage	$V_{IOUT(Q)}$	Bidirectional; $I_P = 0\text{ A}$	-	$V_{CC} / 2$	-	V
<b>ACCURACY PERFORMANCE</b>						
Noise	$V_N$	$T_A = 25^\circ\text{C}$ , $C_L = 1\text{ nF}$	-	5.1	-	mV <sub>p-p</sub>
		$T_A = 25^\circ\text{C}$ , $C_L = 1\text{ nF}$	-	0.85	-	mV <sub>RMS</sub>
Sensitivity Error	$E_{Sens}$	$I_P = 200\text{ A}$ , not tested at full scale $I_P$ ; $T_A = 25^\circ\text{C}$	-1	$\pm 0.7$	1	%
		$I_P = 200\text{ A}$ , not tested at full scale $I_P$ ; $T_A = 25^\circ\text{C}$ to $150^\circ\text{C}$	-1.25	$\pm 0.8$	1.25	%
		$I_P = 200\text{ A}$ , not tested at full scale $I_P$ ; $T_A = -40^\circ\text{C}$ to $25^\circ\text{C}$	-3.5	$\pm 1.7$	3.5	%
Electrical Offset Error	$V_{OE(TA)}$	$I_P = 0\text{ A}$ , $T_A = 25^\circ\text{C}$	-8	$\pm 4$	8	mV
	$V_{OE(TA)HT}$	$I_P = 0\text{ A}$ , $T_A = 25^\circ\text{C}$ to $150^\circ\text{C}$	-8	$\pm 4$	8	mV
	$V_{OE(TA)LT}$	$I_P = 0\text{ A}$ , $T_A = -40^\circ\text{C}$ to $25^\circ\text{C}$	-20	$\pm 6$	20	mV
Magnetic Offset Error	$I_{ERROM}$	$I_P = 0\text{ A}$ , $T_A = 25^\circ\text{C}$ , after excursion of $I_{PR(\max)}$	-	175	400	mA
Total Output Error	$E_{TOT(HT)}$	$I_P = 200\text{ A}$ , not tested at full scale $I_P$ ; $T_A = 25^\circ\text{C}$ to $150^\circ\text{C}$	-1.5	$\pm 0.9$	1.5	%
	$E_{TOT(LT)}$	$I_P = 200\text{ A}$ , not tested at full scale $I_P$ ; $T_A = -40^\circ\text{C}$ to $25^\circ\text{C}$	-3.5	$\pm 1.7$	3.5	%
<b>LIFETIME ACCURACY CHARACTERISTICS [3]</b>						
Sensitivity Error Including Lifetime	$E_{Sens(LIFE)(HT)}$	$T_A = 25^\circ\text{C}$ to $150^\circ\text{C}$	-2.1	$\pm 1.6$	2.1	%
	$E_{Sens(LIFE)(LT)}$	$T_A = -40^\circ\text{C}$ to $25^\circ\text{C}$	-3.5	$\pm 2.5$	3.5	%
Total Output Error Including Lifetime	$E_{TOT(LIFE)(HT)}$	$T_A = 25^\circ\text{C}$ to $150^\circ\text{C}$	-2.1	$\pm 1.7$	2.1	%
	$E_{TOT(LIFE)(LT)}$	$T_A = -40^\circ\text{C}$ to $25^\circ\text{C}$	-3.5	$\pm 2.6$	3.5	%
Electric Offset Error Including Lifetime	$E_{OFF(LIFE)(HT)}$	$T_A = 25^\circ\text{C}$ to $150^\circ\text{C}$	-10	$\pm 7$	10	mV
	$E_{OFF(LIFE)(LT)}$	$T_A = -40^\circ\text{C}$ to $25^\circ\text{C}$	-20	$\pm 8.9$	20	mV

[1] All ACS772 devices are production tested and guaranteed to  $T_A = 150^\circ\text{C}$ , provided the Maximum Junction Temperature,  $T_{J(\max)}$ , is not exceeded. See Absolute Maximum Ratings and Thermal Application section of this datasheet for more information.

[2] Typical values are  $\pm 3$  sigma values.

[3] Min/max limits are derived from AEC-Q100 Grade 1 testing.

**X400U PERFORMANCE CHARACTERISTICS:  $T_A = -40^\circ\text{C}$  to  $150^\circ\text{C}$  [1],  $V_{CC} = 5\text{ V}$ , unless otherwise specified**

Characteristic	Symbol	Test Conditions	Min.	Typ. [2]	Max.	Unit
<b>NOMINAL PERFORMANCE</b>						
Current Sensing Range	$I_{PR}$		0	–	400	A
Sensitivity	Sens	$I_{PR(\min)} < I_P < I_{PR(\max)}$	–	$10 \times V_{CC} / 5$	–	mV/A
Zero Current Output Voltage	$V_{IOUT(Q)}$	Unidirectional; $I_P = 0\text{ A}$	–	$V_{CC} / 10$	–	V
<b>ACCURACY PERFORMANCE</b>						
Noise	$V_N$	$T_A = 25^\circ\text{C}$ , $C_L = 1\text{ nF}$	–	5.1	–	mV <sub>p-p</sub>
		$T_A = 25^\circ\text{C}$ , $C_L = 1\text{ nF}$	–	0.85	–	mV <sub>RMS</sub>
Sensitivity Error	$E_{Sens}$	$I_P = 200\text{ A}$ , not tested at full scale $I_P$ ; $T_A = 25^\circ\text{C}$	–1	$\pm 0.5$	1	%
		$I_P = 200\text{ A}$ , not tested at full scale $I_P$ ; $T_A = 25^\circ\text{C}$ to $150^\circ\text{C}$	–1.25	$\pm 0.7$	1.25	%
		$I_P = 200\text{ A}$ , not tested at full scale $I_P$ ; $T_A = -40^\circ\text{C}$ to $25^\circ\text{C}$	–3.5	$\pm 1.5$	3.5	%
Electrical Offset Error	$V_{OE(TA)}$	$I_P = 0\text{ A}$ , $T_A = 25^\circ\text{C}$	–8	$\pm 4$	8	mV
	$V_{OE(TA)HT}$	$I_P = 0\text{ A}$ , $T_A = 25^\circ\text{C}$ to $150^\circ\text{C}$	–8	$\pm 4$	8	mV
	$V_{OE(TA)LT}$	$I_P = 0\text{ A}$ , $T_A = -40^\circ\text{C}$ to $25^\circ\text{C}$	–20	$\pm 6$	20	mV
Magnetic Offset Error	$I_{ERROM}$	$I_P = 0\text{ A}$ , $T_A = 25^\circ\text{C}$ , after excursion of $I_{PR(\max)}$	–	245	400	mA
Total Output Error	$E_{TOT(HT)}$	$I_P = 200\text{ A}$ , not tested at full scale $I_P$ ; $T_A = 25^\circ\text{C}$ to $150^\circ\text{C}$	–1.5	$\pm 0.8$	1.5	%
	$E_{TOT(LT)}$	$I_P = 200\text{ A}$ , not tested at full scale $I_P$ ; $T_A = -40^\circ\text{C}$ to $25^\circ\text{C}$	–3.5	$\pm 2.7$	3.5	%
<b>LIFETIME ACCURACY CHARACTERISTICS [3]</b>						
Sensitivity Error Including Lifetime	$E_{Sens(LIFE)(HT)}$	$T_A = 25^\circ\text{C}$ to $150^\circ\text{C}$	–2.1	$\pm 1.6$	2.1	%
	$E_{Sens(LIFE)(LT)}$	$T_A = -40^\circ\text{C}$ to $25^\circ\text{C}$	–3.5	$\pm 2.5$	3.5	%
Total Output Error Including Lifetime	$E_{TOT(LIFE)(HT)}$	$T_A = 25^\circ\text{C}$ to $150^\circ\text{C}$	–2.1	$\pm 1.7$	2.1	%
	$E_{TOT(LIFE)(LT)}$	$T_A = -40^\circ\text{C}$ to $25^\circ\text{C}$	–3.5	$\pm 2.6$	3.5	%
Electric Offset Error Including Lifetime	$E_{OFF(LIFE)(HT)}$	$T_A = 25^\circ\text{C}$ to $150^\circ\text{C}$	–10	$\pm 7$	10	mV
	$E_{OFF(LIFE)(LT)}$	$T_A = -40^\circ\text{C}$ to $25^\circ\text{C}$	–20	$\pm 8.9$	20	mV

[1] All ACS772 devices are production tested and guaranteed to  $T_A = 150^\circ\text{C}$ , provided the Maximum Junction Temperature,  $T_{J(\max)}$ , is not exceeded. See Absolute Maximum Ratings and Thermal Application section of this datasheet for more information.

[2] Typical values are  $\pm 3$  sigma values. Typical values may be reevaluated once the specific part number is released to production.

[3] Min/max limits are derived from AEC-Q100 Grade 1 testing.

**X400B PERFORMANCE CHARACTERISTICS:  $T_A = -40^\circ\text{C}$  to  $150^\circ\text{C}$  [1],  $V_{CC} = 5\text{ V}$ , unless otherwise specified**

Characteristic	Symbol	Test Conditions	Min.	Typ. [2]	Max.	Unit
<b>NOMINAL PERFORMANCE</b>						
Current Sensing Range	$I_{PR}$		-400	-	400	A
Sensitivity	Sens	$I_{PR(\min)} < I_P < I_{PR(\max)}$	-	$5 \times V_{CC} / 5$	-	mV/A
Zero Current Output Voltage	$V_{IOUT(Q)}$	Bidirectional; $I_P = 0\text{ A}$	-	$V_{CC} / 2$	-	V
<b>ACCURACY PERFORMANCE</b>						
Noise	$V_N$	$T_A = 25^\circ\text{C}$ , $C_L = 1\text{ nF}$	-	5.1	-	mV <sub>p-p</sub>
		$T_A = 25^\circ\text{C}$ , $C_L = 1\text{ nF}$	-	0.85	-	mV <sub>RMS</sub>
Sensitivity Error	$E_{Sens}$	$I_P = 200\text{ A}$ , not tested at full scale $I_P$ ; $T_A = 25^\circ\text{C}$	-1	$\pm 0.7$	1	%
		$I_P = 200\text{ A}$ , not tested at full scale $I_P$ ; $T_A = 25^\circ\text{C}$ to $150^\circ\text{C}$	-1.25	$\pm 0.8$	1.25	%
		$I_P = 200\text{ A}$ , not tested at full scale $I_P$ ; $T_A = -40^\circ\text{C}$ to $25^\circ\text{C}$	-3.5	$\pm 1.7$	3.5	%
Electrical Offset Error	$V_{OE(TA)}$	$I_P = 0\text{ A}$ , $T_A = 25^\circ\text{C}$	-8	$\pm 4$	8	mV
	$V_{OE(TA)HT}$	$I_P = 0\text{ A}$ , $T_A = 25^\circ\text{C}$ to $150^\circ\text{C}$	-8	$\pm 4$	8	mV
	$V_{OE(TA)LT}$	$I_P = 0\text{ A}$ , $T_A = -40^\circ\text{C}$ to $25^\circ\text{C}$	-20	$\pm 6$	20	mV
Magnetic Offset Error	$I_{ERRORM}$	$I_P = 0\text{ A}$ , $T_A = 25^\circ\text{C}$ , after excursion of $I_{PR(\max)}$	-	175	400	mA
Total Output Error	$E_{TOT(HT)}$	$I_P = 200\text{ A}$ , not tested at full scale $I_P$ ; $T_A = 25^\circ\text{C}$ to $150^\circ\text{C}$	-1.5	$\pm 0.9$	1.5	%
	$E_{TOT(LT)}$	$I_P = 200\text{ A}$ , not tested at full scale $I_P$ ; $T_A = -40^\circ\text{C}$ to $25^\circ\text{C}$	-3.5	$\pm 1.7$	3.5	%
<b>LIFETIME ACCURACY CHARACTERISTICS [3]</b>						
Sensitivity Error Including Lifetime	$E_{Sens(LIFE)(HT)}$	$T_A = 25^\circ\text{C}$ to $150^\circ\text{C}$	-2.1	$\pm 1.6$	2.1	%
	$E_{Sens(LIFE)(LT)}$	$T_A = -40^\circ\text{C}$ to $25^\circ\text{C}$	-3.5	$\pm 2.5$	3.5	%
Total Output Error Including Lifetime	$E_{TOT(LIFE)(HT)}$	$T_A = 25^\circ\text{C}$ to $150^\circ\text{C}$	-2.1	$\pm 1.7$	2.1	%
	$E_{TOT(LIFE)(LT)}$	$T_A = -40^\circ\text{C}$ to $25^\circ\text{C}$	-3.5	$\pm 2.6$	3.5	%
Electric Offset Error Including Lifetime	$E_{OFF(LIFE)(HT)}$	$T_A = 25^\circ\text{C}$ to $150^\circ\text{C}$	-10	$\pm 7$	10	mV
	$E_{OFF(LIFE)(LT)}$	$T_A = -40^\circ\text{C}$ to $25^\circ\text{C}$	-20	$\pm 8.9$	20	mV

[1] All ACS772 devices are production tested and guaranteed to  $T_A = 150^\circ\text{C}$ , provided the Maximum Junction Temperature,  $T_{J(\max)}$ , is not exceeded. See Absolute Maximum Ratings and Thermal Application section of this datasheet for more information.

[2] Typical values are  $\pm 3$  sigma values.

[3] Min/max limits are derived from AEC-Q100 Grade 1 testing.

### CHARACTERISTIC PERFORMANCE DATA

#### ACS772LCB-050U-PFF-T

Electrical Offset Voltage versus Ambient Temperature

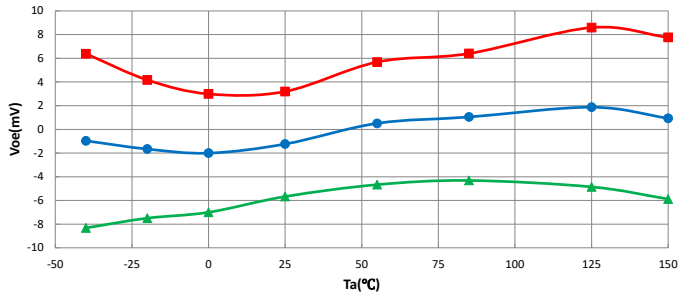

Sensitivity versus Ambient Temperature

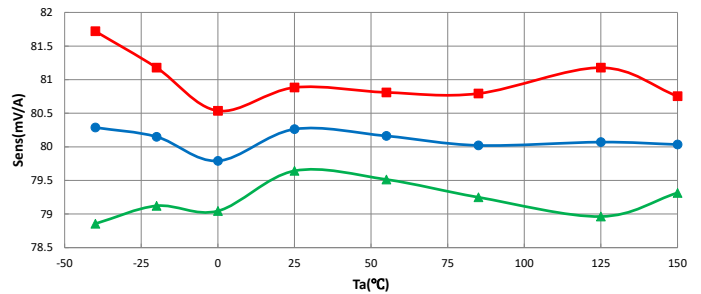

Nonlinearity versus Ambient Temperature

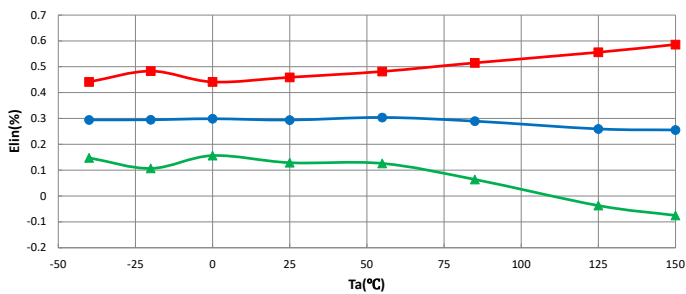

Total Output Error versus Ambient Temperature

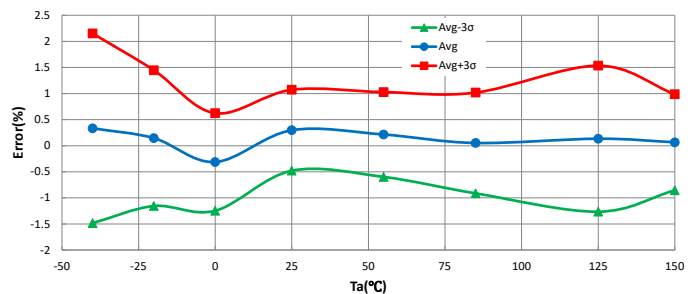

Magnetic Offset Error versus Ambient Temperature

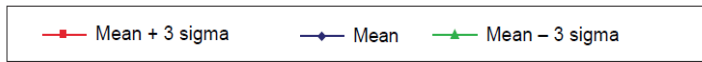
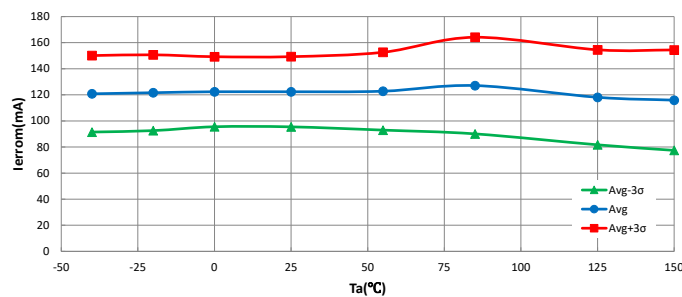

### CHARACTERISTIC PERFORMANCE DATA

#### ACS772LCB-050B-PFF-T

Electrical Offset Voltage versus Ambient Temperature

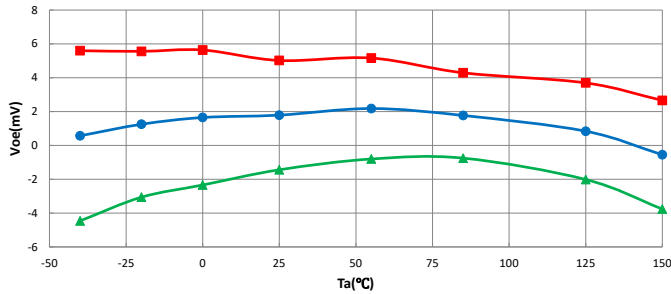

Sensitivity versus Ambient Temperature

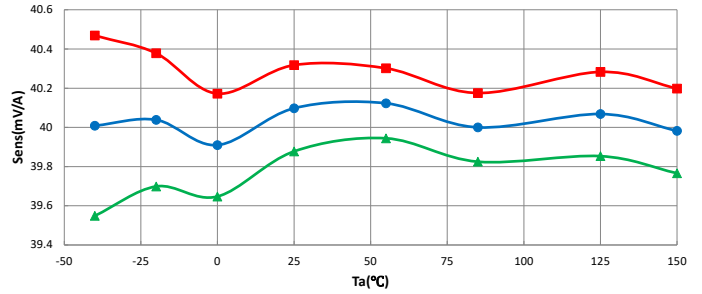

Nonlinearity versus Ambient Temperature

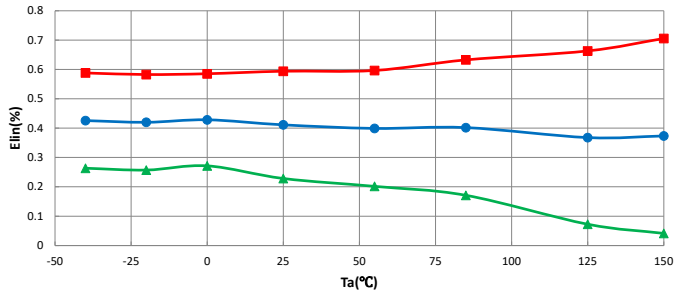

Total Output Error versus Ambient Temperature

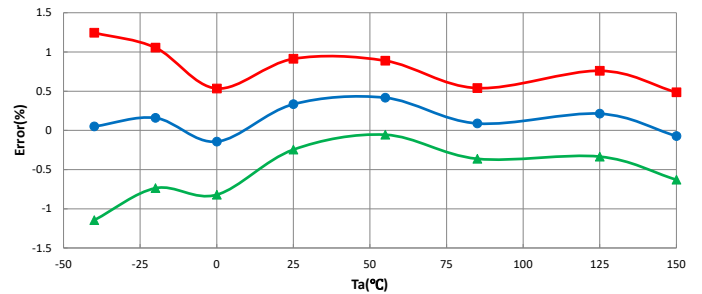

Magnetic Offset Error versus Ambient Temperature

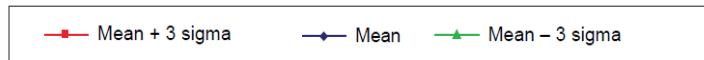
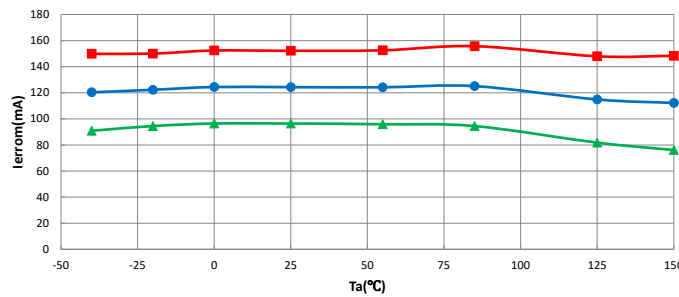

### CHARACTERISTIC PERFORMANCE DATA

#### ACS772LCB-100U-PFF-T

Electrical Offset Voltage versus Ambient Temperature

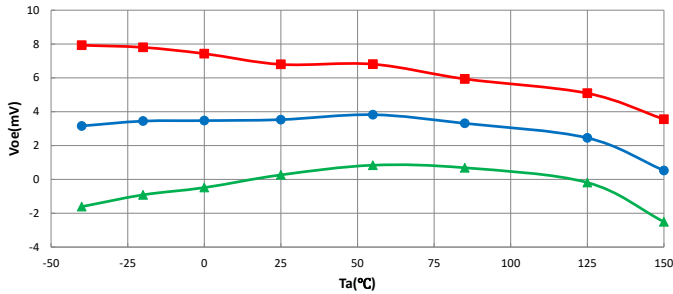

Sensitivity versus Ambient Temperature

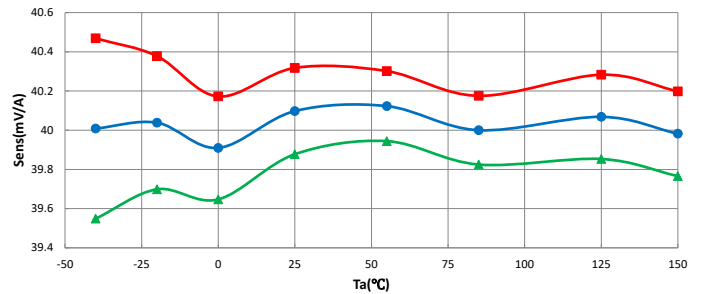

Nonlinearity versus Ambient Temperature

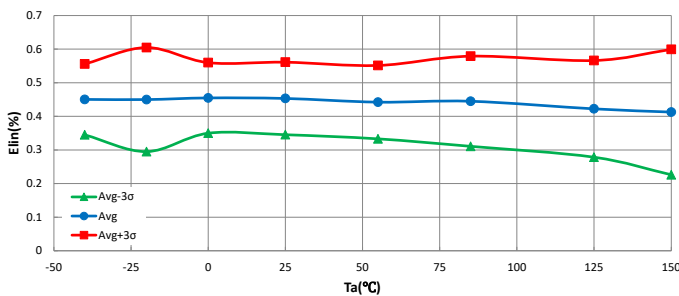

Total Output Error versus Ambient Temperature

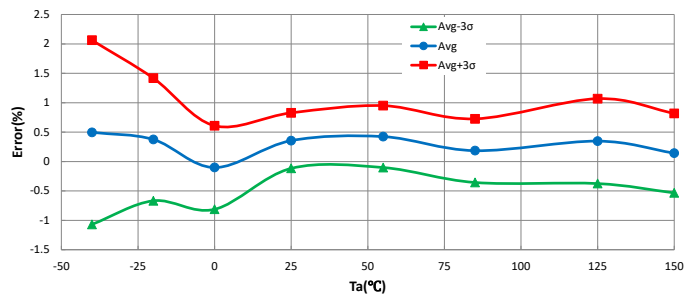

Magnetic Offset Error versus Ambient Temperature

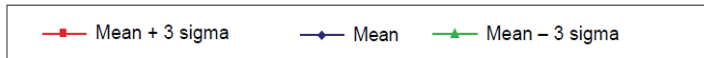
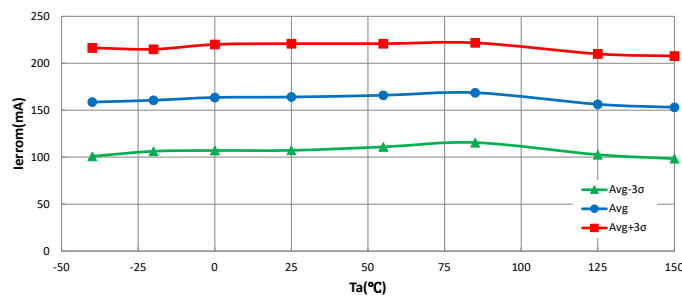

### CHARACTERISTIC PERFORMANCE DATA

#### ACS772LCB-100B-PFF-T

Electrical Offset Voltage versus Ambient Temperature

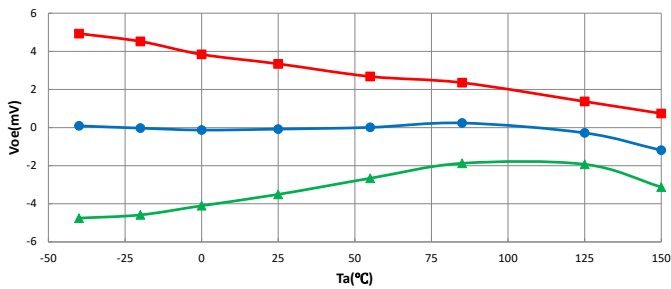

Sensitivity versus Ambient Temperature

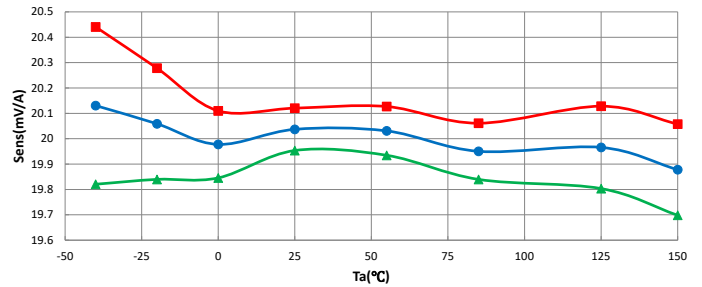

Nonlinearity versus Ambient Temperature

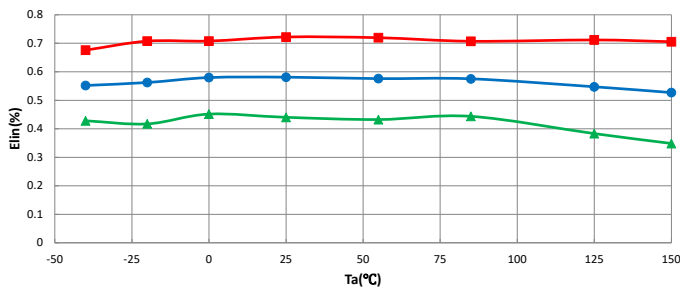

Total Output Error versus Ambient Temperature

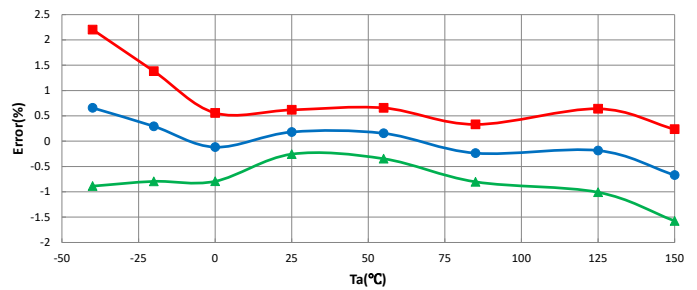

Magnetic Offset Error versus Ambient Temperature

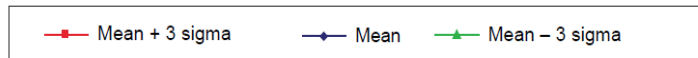
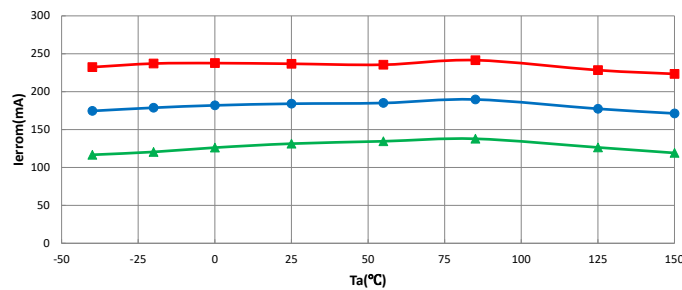

### CHARACTERISTIC PERFORMANCE DATA

#### ACS772KCB-150U-PFF-T

Electrical Offset Voltage versus Ambient Temperature

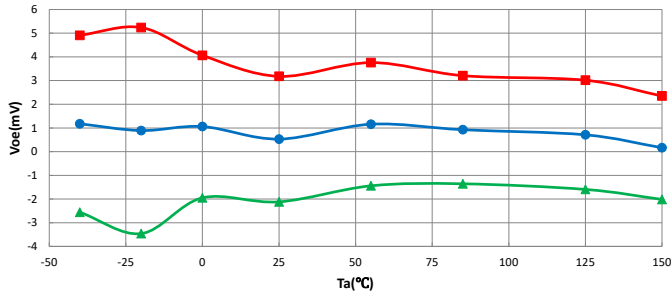

Sensitivity versus Ambient Temperature

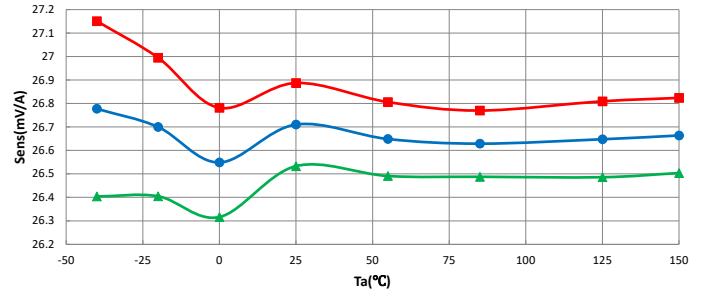

Nonlinearity versus Ambient Temperature

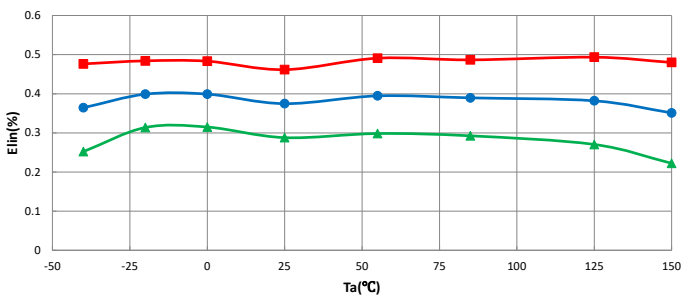

Total Output Error versus Ambient Temperature

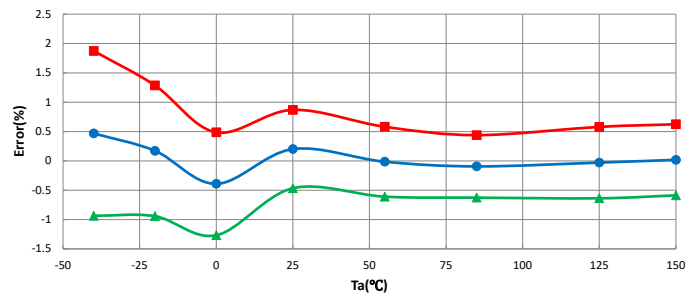

Magnetic Offset Error versus Ambient Temperature

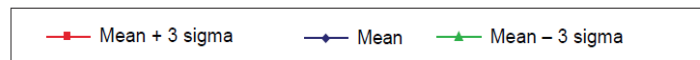
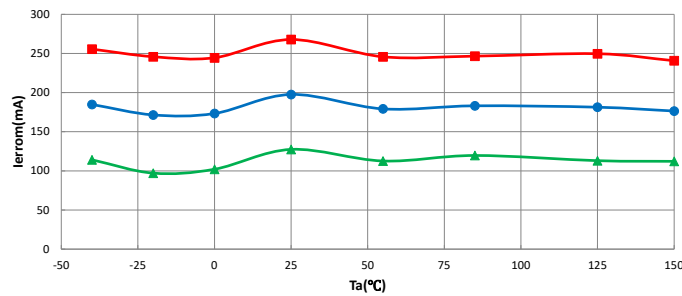



### CHARACTERISTIC PERFORMANCE DATA

#### ACS772KCB-150B-PFF-T

Electrical Offset Voltage versus Ambient Temperature

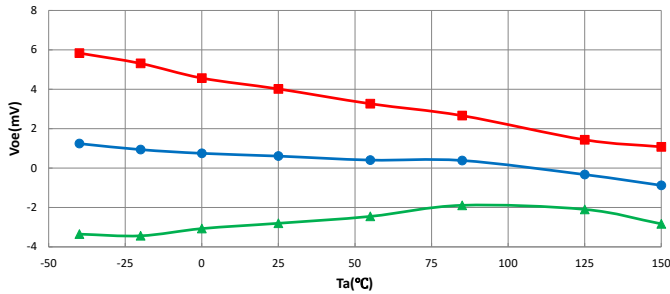

Sensitivity versus Ambient Temperature

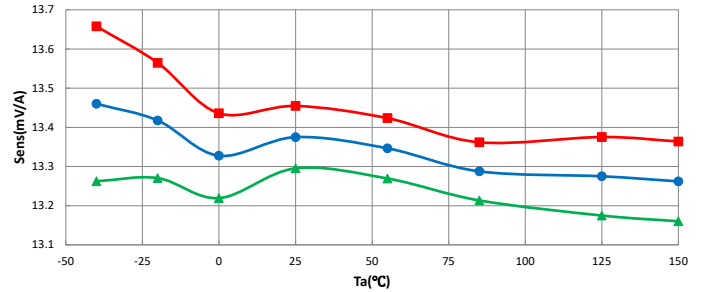

Nonlinearity versus Ambient Temperature

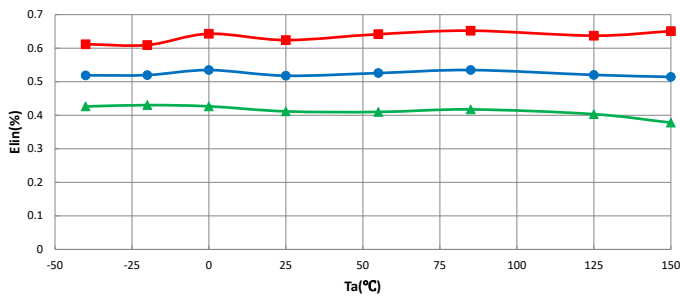

Total Output Error versus Ambient Temperature

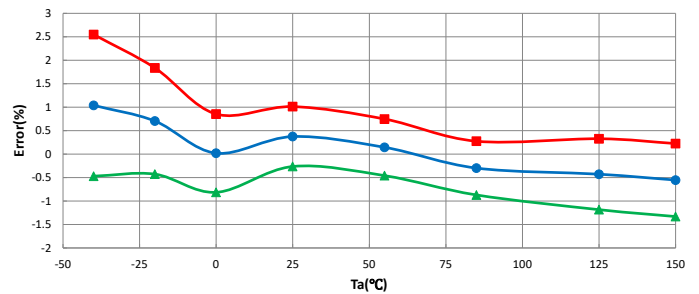

Magnetic Offset Error versus Ambient Temperature

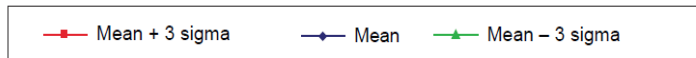
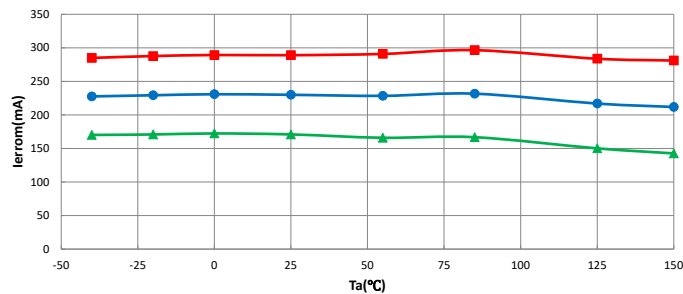

### CHARACTERISTIC PERFORMANCE DATA

#### ACS772ECB-200U-PFF-T

Electrical Offset Voltage versus Ambient Temperature

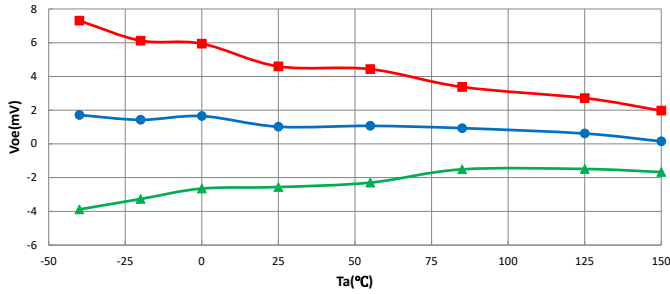

Sensitivity versus Ambient Temperature

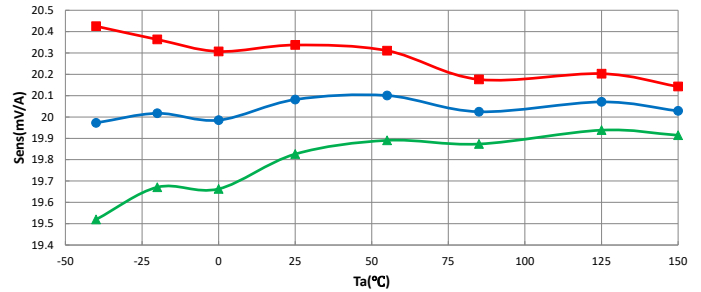

Nonlinearity versus Ambient Temperature

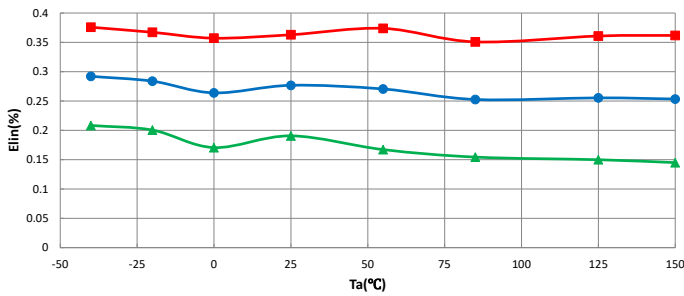

Total Output Error versus Ambient Temperature

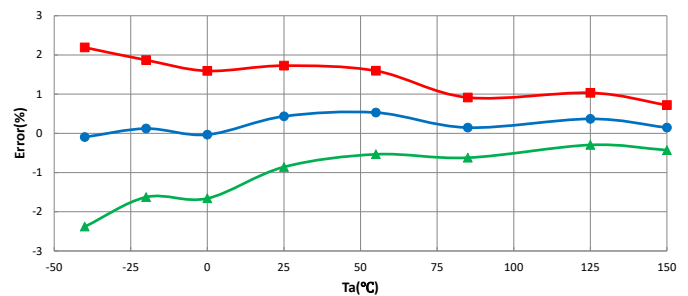

Magnetic Offset Error versus Ambient Temperature

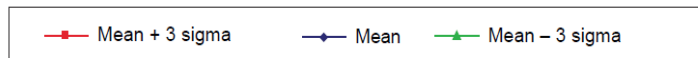
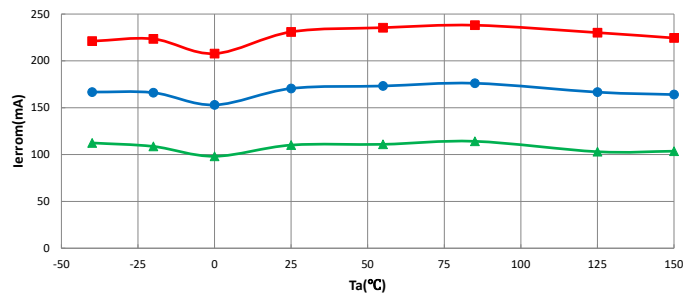

### CHARACTERISTIC PERFORMANCE DATA

#### ACS772ECB-200B-PFF-T

Electrical Offset Voltage versus Ambient Temperature

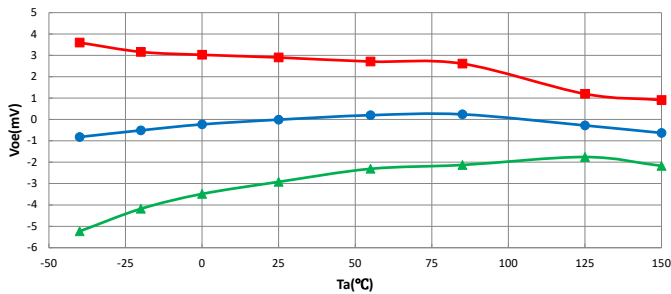

Sensitivity versus Ambient Temperature

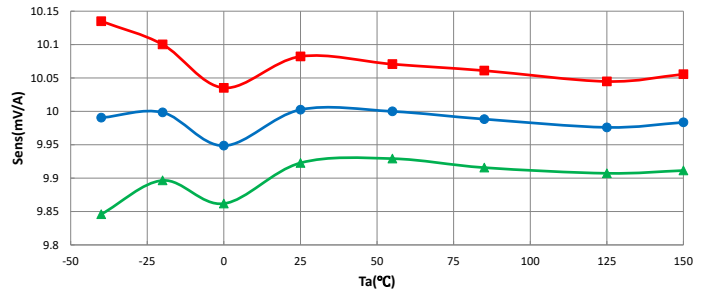

Nonlinearity versus Ambient Temperature

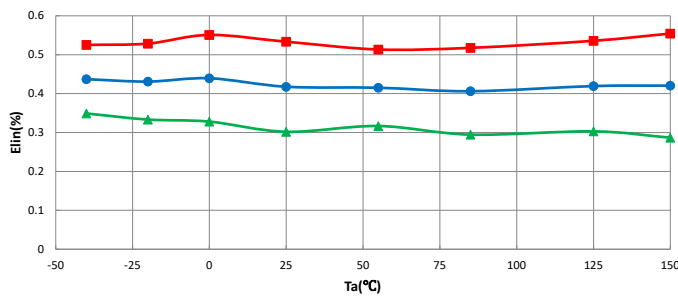

Total Output Error versus Ambient Temperature

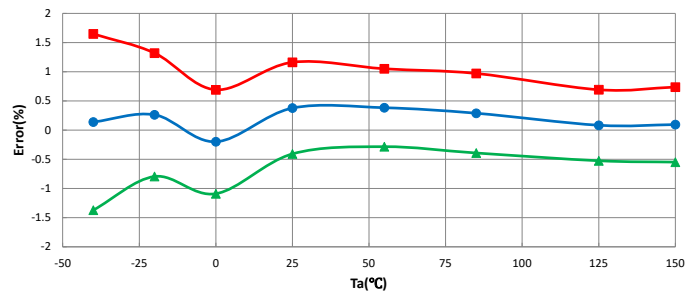

Magnetic Offset Error versus Ambient Temperature

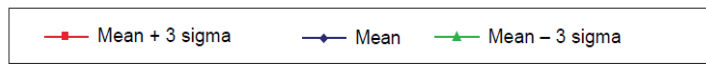
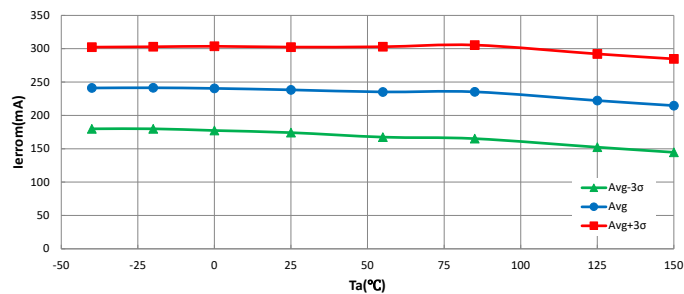

### CHARACTERISTIC PERFORMANCE DATA

#### ACS772ECB-250U-PFF-T

Electrical Offset Voltage versus Ambient Temperature

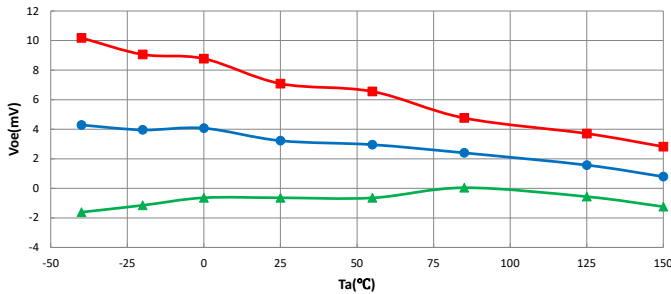

Sensitivity versus Ambient Temperature

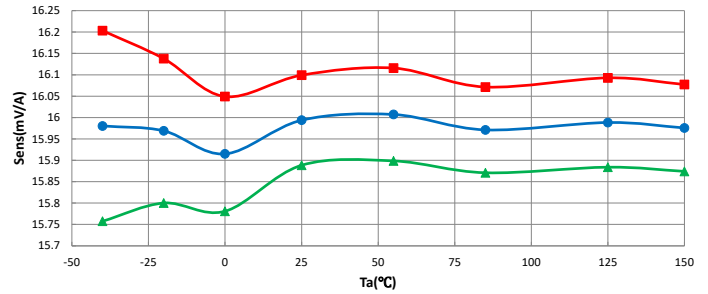

Nonlinearity versus Ambient Temperature<sup>[1]</sup>

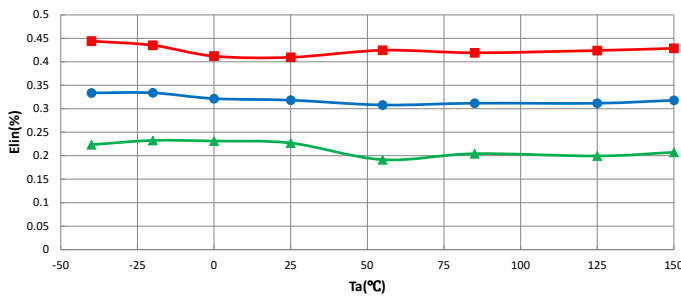

Total Output Error versus Ambient Temperature

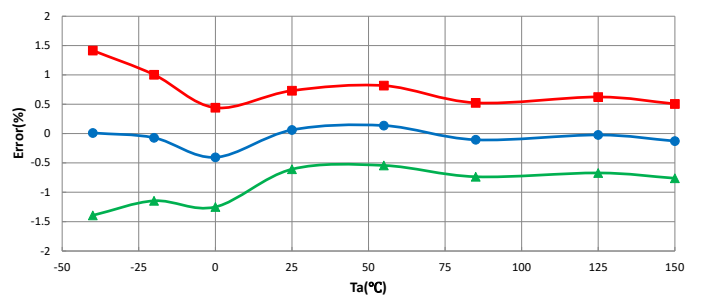

Magnetic Offset Error versus Ambient Temperature

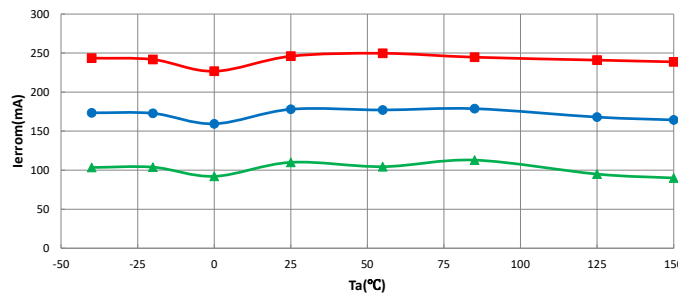

[1] Nonlinearity versus Ambient Temperature Performance Plot is valid for applied currents less than 200 A.

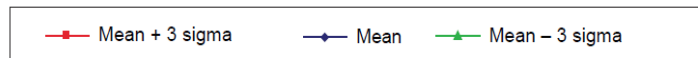

### CHARACTERISTIC PERFORMANCE DATA

#### ACS772ECB-250B-PFF-T

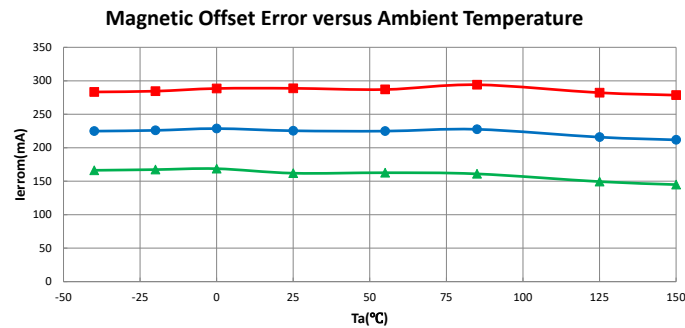
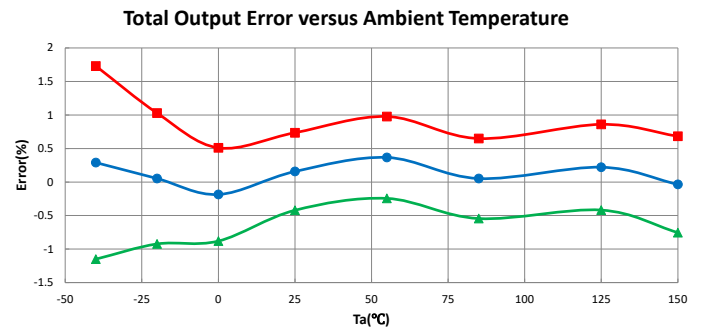
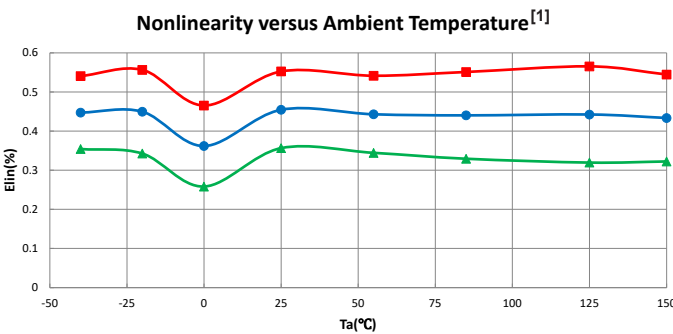
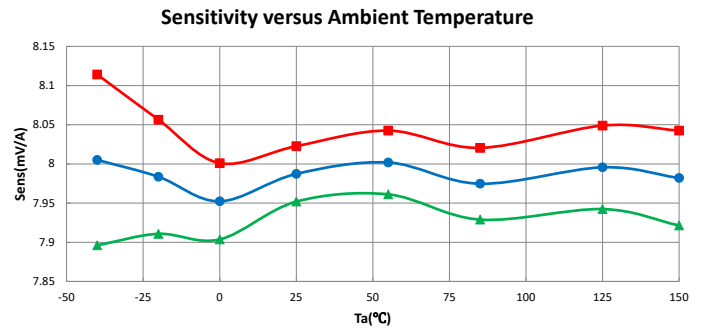
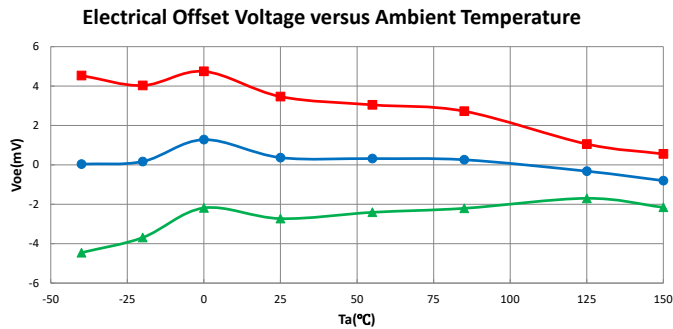

[1] Nonlinearity versus Ambient Temperature Performance Plot is valid for applied currents less than 200 A.

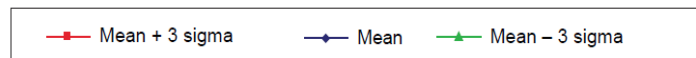

### CHARACTERISTIC PERFORMANCE DATA ACS772ECB-400B-PFF-T

Electrical Offset Voltage versus Ambient Temperature

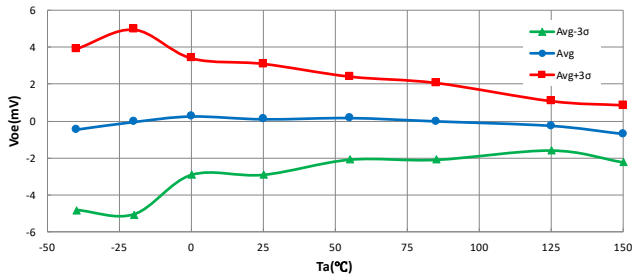

Sensitivity versus Ambient Temperature

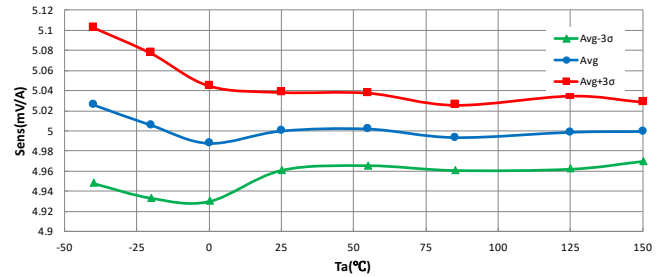

Nonlinearity versus Ambient Temperature<sup>[1]</sup>

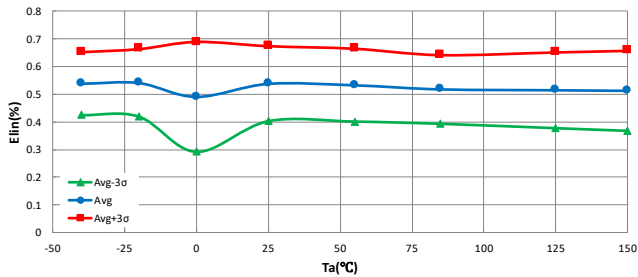

Total Output Error versus Ambient Temperature

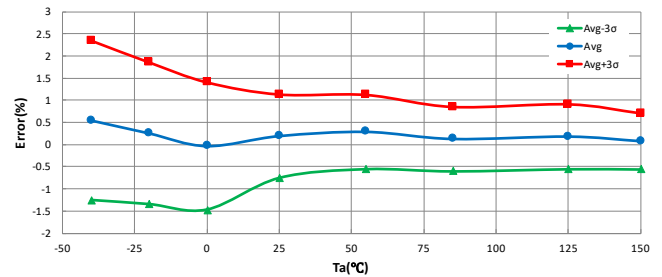

Magnetic Offset Error versus Ambient Temperature

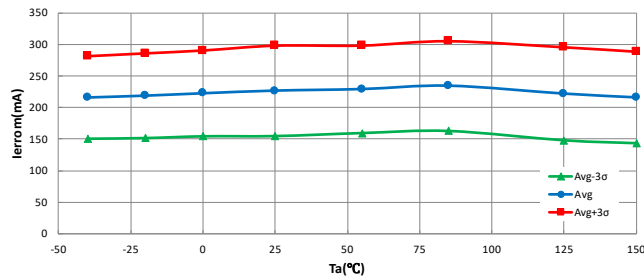

<sup>[1]</sup> Nonlinearity versus Ambient Temperature Performance Plot is valid for applied currents less than 200 A.

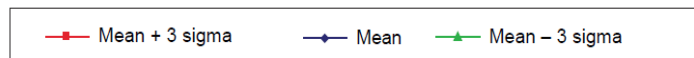

### CHARACTERISTIC PERFORMANCE DATA

#### Response Time ( $t_{\text{RESPONSE}}$ )

70 A excitation signal with 10%-90% rise time = 1  $\mu\text{s}$

Sensitivity = 13.33 mV/A,  $T_A = 25^\circ\text{C}$ ,  $C_{\text{BYPASS}} = 0.1 \mu\text{F}$ ,  $C_{\text{LOAD}} = 1 \text{nF}$

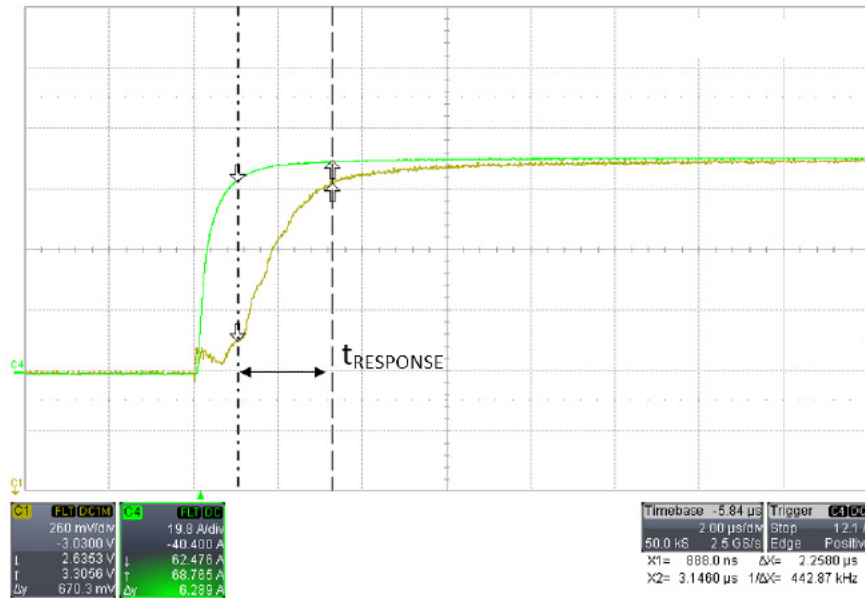

#### Propagation Delay ( $t_{\text{PROP}}$ )

70 A excitation signal with 10%-90% rise time = 1  $\mu\text{s}$

Sensitivity = 13.33 mV/A,  $T_A = 25^\circ\text{C}$ ,  $C_{\text{BYPASS}} = 0.1 \mu\text{F}$ ,  $C_{\text{LOAD}} = 1 \text{nF}$

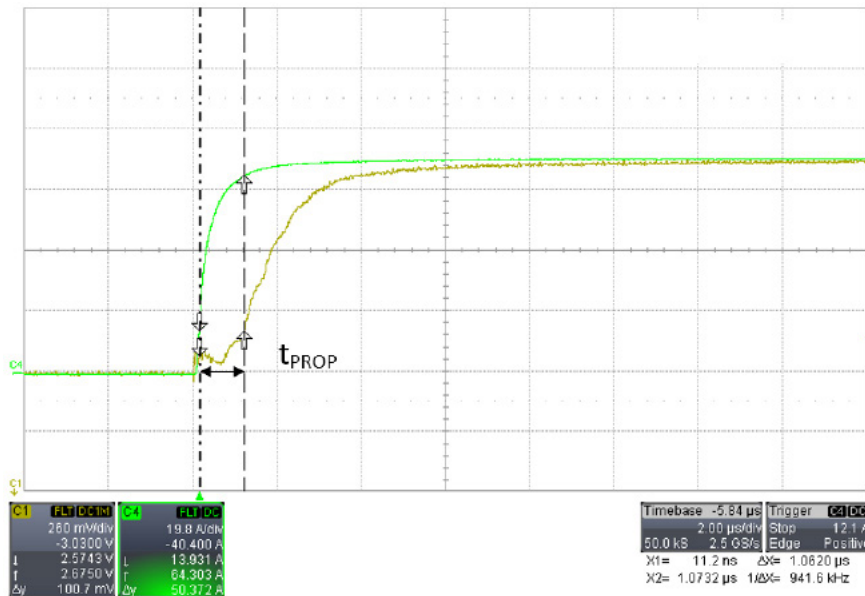

### Rise Time ( $t_R$ )

70 A excitation signal with 10%-90% rise time = 1  $\mu\text{s}$

Sensitivity = 13.33 mV/A,  $T_A = 25^\circ\text{C}$ ,  $C_{\text{BYPASS}} = 0.1 \mu\text{F}$ ,  $C_{\text{LOAD}} = 1 \text{ nF}$

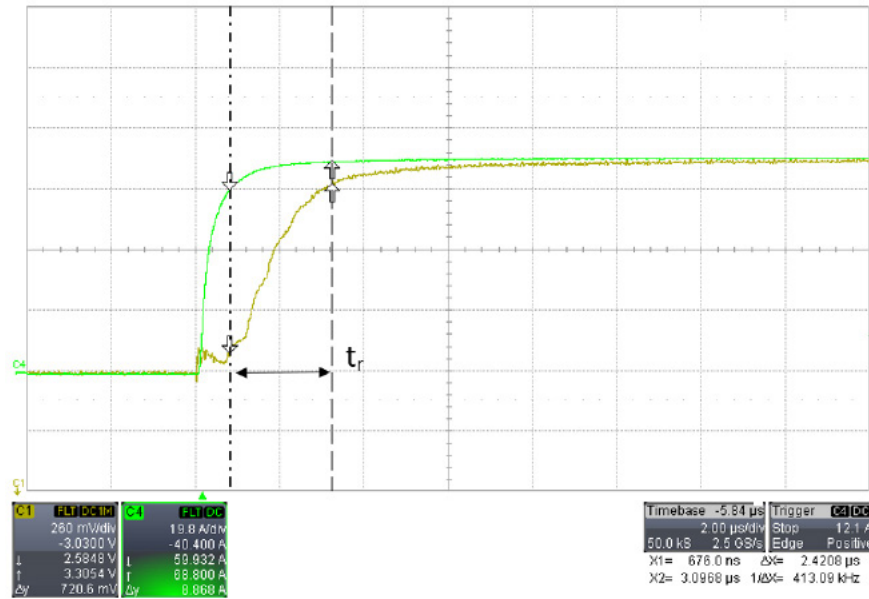



### UVLO Enable Time ( $t_{UVLOE}$ )

$V_{CC}$  5 V to 3 V fall time = 1.5  $\mu\text{s}$ ,  $C_L$  = 1 nF

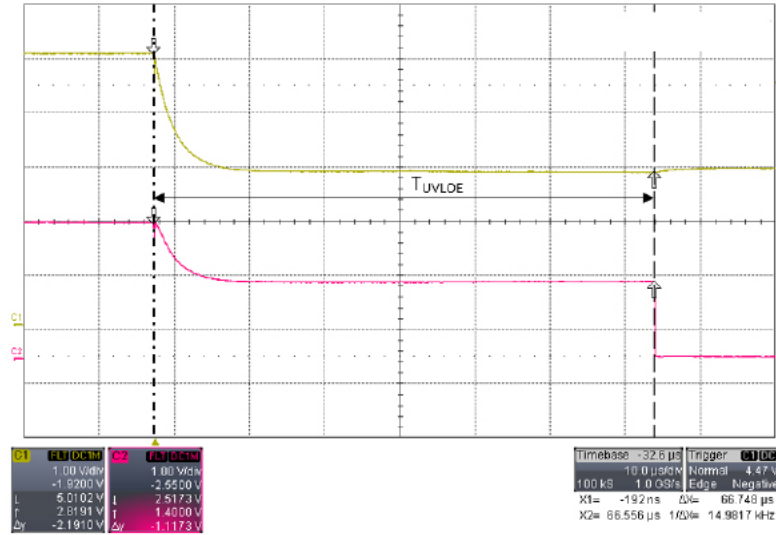

### UVLO Disble Time ( $t_{UVLOD}$ )

$V_{CC}$  3 V to 5 V recovery time = 1.5  $\mu\text{s}$ ,  $C_L$  = 1 nF

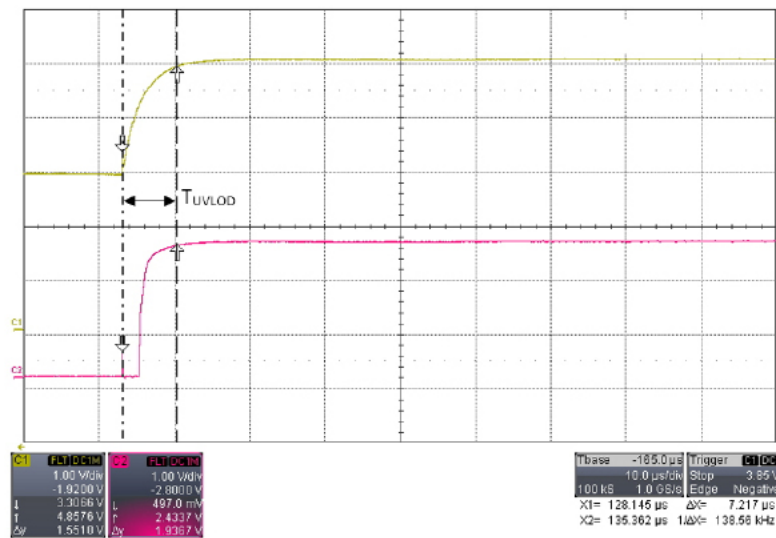

### CHARACTERISTIC DEFINITIONS

#### Definitions of Accuracy Characteristics

##### SENSITIVITY ( $S_{\text{Sens}}$ )

The change in sensor IC output in response to a 1 A change through the primary conductor. The sensitivity is the product of the magnetic circuit sensitivity (G/A; 1 G = 0.1 mT) and the linear IC amplifier gain (mV/G). The linear IC amplifier gain is programmed at the factory to optimize the sensitivity (mV/A) for the full-scale current of the device.

##### SENSITIVITY ERROR ( $E_{\text{Sens}}$ )

The sensitivity error is the percent difference between the measured sensitivity and the ideal sensitivity. For example, in the case of  $V_{\text{CC}} = 5 \text{ V}$ :

$$E_{\text{Sens}} = \frac{S_{\text{SensMeas}}(5\text{V}) - S_{\text{SensIdeal}}(5\text{V})}{S_{\text{SensIdeal}}(5\text{V})} \times 100 (\%)$$

##### NOISE ( $V_{\text{N}}$ )

The noise floor is derived from the thermal and shot noise observed in Hall elements. Dividing the noise (mV) by the sensitivity (mV/A) provides the smallest current that the device is able to resolve.

##### NONLINEARITY ( $E_{\text{LIN}}$ )

The ACS772 is designed to provide a linear output in response to a ramping current. Consider two current levels:  $I_1$  and  $I_2$ . Ideally, the sensitivity of a device is the same for both currents, for a given supply voltage and temperature. Nonlinearity is present when there is a difference between the sensitivities measured at  $I_1$  and  $I_2$ . Nonlinearity is calculated separately for the positive ( $E_{\text{LINpos}}$ ) and negative ( $E_{\text{LINneg}}$ ) applied currents as follows:

$$E_{\text{LINpos}} = 100 (\%) \times \{1 - (S_{\text{SensIPos2}} / S_{\text{SensIPos1}})\}$$

$$E_{\text{LINneg}} = 100 (\%) \times \{1 - (S_{\text{SensINeg2}} / S_{\text{SensINeg1}})\}$$

where:

$$S_{\text{SensIx}} = (V_{\text{IOUT(Ix)}} - V_{\text{IOUT(Q)}}) / I_x$$

and  $I_{\text{POSx}}$  and  $I_{\text{NEGx}}$  are positive and negative currents and  $I_{\text{POS2}} = 2 \times I_{\text{POS1}}$  and  $I_{\text{NEG2}} = 2 \times I_{\text{NEG1}}$ .

Then:

$$E_{\text{LIN}} = \max(E_{\text{LINpos}}, E_{\text{LINneg}})$$

Due to core saturation, the nonlinearity error will increase when applied current exceeds 200 A. Refer to the Sensitivity Error vs. Applied Current plots below.

##### SYMMETRY ( $E_{\text{SYM}}$ )

The degree to which the absolute voltage output from the IC varies in proportion to either a positive or negative half-scale primary current. The following equation is used to derive symmetry:

$$100 \times \left( \frac{V_{\text{IOUT+half-scale amperes}} - V_{\text{IOUT(Q)}}}{V_{\text{IOUT(Q)}} - V_{\text{IOUT-half-scale amperes}}} \right)$$

##### RATIOMETRY ERROR

The device features a ratiometric output. This means that the quiescent voltage output,  $V_{\text{IOUT(Q)}}$ , and the magnetic sensitivity,  $S_{\text{Sens}}$ , are proportional to the supply voltage,  $V_{\text{CC}}$ . The ratiometric change (%) in the quiescent voltage output is defined as:

$$\text{Rat}_{\text{ErrQVO}} = \left[ 1 - \frac{(V_{\text{IOUTQ}(V_{\text{CC}})} / V_{\text{IOUTQ}(5\text{V})})}{V_{\text{CC}} / 5 \text{ V}} \right] \times 100\%$$

and the ratiometric change (%) in sensitivity is defined as:

$$\text{Rat}_{\text{ErrSens}} = \left[ 1 - \frac{(S_{\text{Sens}(V_{\text{CC}})} / S_{\text{Sens}(5\text{V})})}{V_{\text{CC}} / 5 \text{ V}} \right] \times 100\%$$

##### ZERO CURRENT OUTPUT VOLTAGE ( $V_{\text{IOUT(Q)}}$ )

The output of the sensor when the primary current is zero. It nominally remains at  $0.5 \times V_{\text{CC}}$  for a bidirectional device and  $0.1 \times V_{\text{CC}}$  for a unidirectional device. For example, in the case of a bidirectional output device,  $V_{\text{CC}} = 5 \text{ V}$  translates into  $V_{\text{IOUT(Q)}} = 2.5 \text{ V}$ . Variation in  $V_{\text{IOUT(Q)}}$  can be attributed to the resolution of the Allegro linear IC quiescent voltage trim and thermal drift.

##### ELECTRICAL OFFSET VOLTAGE ( $V_{\text{OE}}$ )

The deviation of the device output from its ideal quiescent value of  $0.5 \times V_{\text{CC}}$  (bidirectional) or  $0.1 \times V_{\text{CC}}$  (unidirectional) due to nonmagnetic causes. To convert this voltage to amperes, divide by the device sensitivity,  $S_{\text{Sens}}$ .

### MAGNETIC OFFSET ERROR ( $I_{ERROM}$ )

The magnetic offset is due to the residual magnetism (remnant field) of the core material. The magnetic offset error is highest when the magnetic circuit has been saturated, usually when the device has been subjected to a full-scale or high-current overload condition. The magnetic offset is largely dependent on the material used as a flux concentrator. The larger magnetic offsets are observed at the lower operating temperatures.

### TOTAL OUTPUT ERROR ( $E_{TOT}$ )

The difference between the current measurement from the sensor IC and the actual current ( $I_P$ ), relative to the actual current. This is equivalent to the difference between the ideal output voltage and the actual output voltage, divided by the ideal sensitivity, relative to the current flowing through the primary conduction path:

$$E_{TOT}(I_P) = \frac{V_{IOUT(IP)} - V_{IOUT(ideal)(IP)}}{Sens_{ideal} \times I_P} \times 100(\%)$$

where

$$V_{IOUT(ideal)(IP)} = V_{IOUT(Q)} + (Sens_{IDEAL} \times I_P)$$

The Total Output Error incorporates all sources of error and is a function of  $I_P$ .

At relatively high currents,  $E_{TOT}$  will be mostly due to sensitivity error, and at relatively low currents,  $E_{TOT}$  will be mostly due to Offset Voltage ( $V_{OE}$ ). In fact, as  $I_P$  approaches zero,  $E_{TOT}$  approaches infinity due to the offset voltage. This is illustrated in Figure 3 and Figure 4. Figure 3 shows a distribution of output voltages versus  $I_P$  at 25°C and across temperature. Figure 4 shows the corresponding  $E_{TOT}$  versus  $I_P$ .

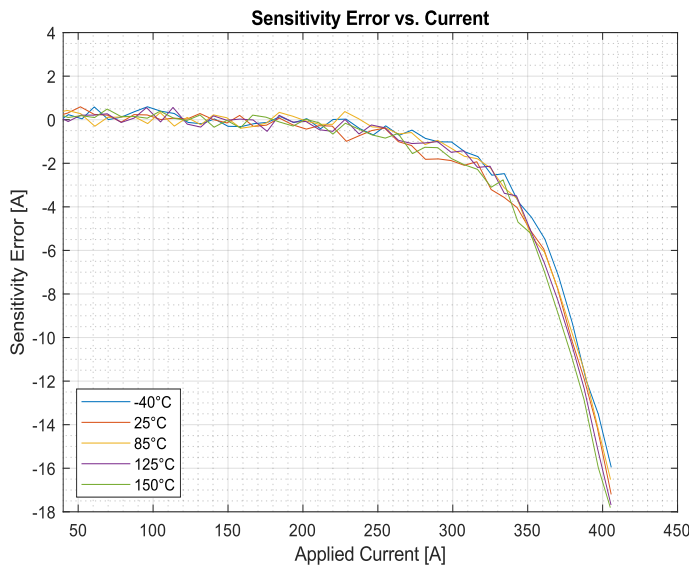

**Figure 1: Sensitivity Error (relative to ideal 5 mV/A) in Amps vs. Applied Current**

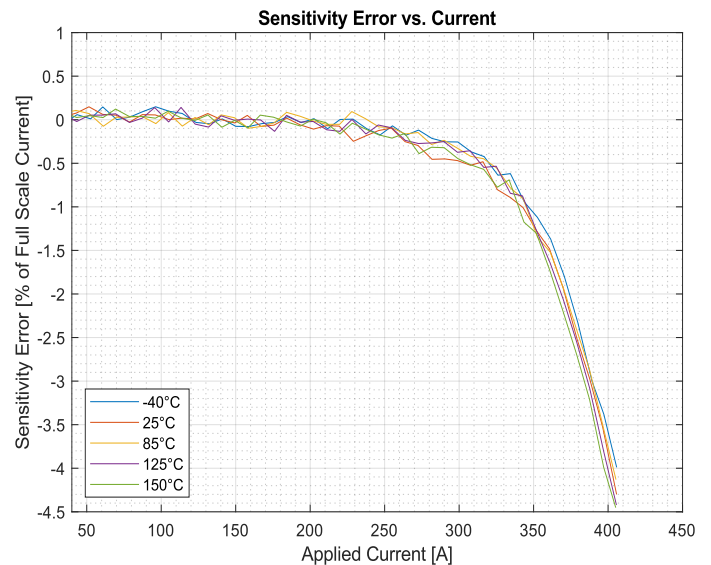

**Figure 2: Sensitivity Error in Percent of Full-Scale Current vs. Applied Current**

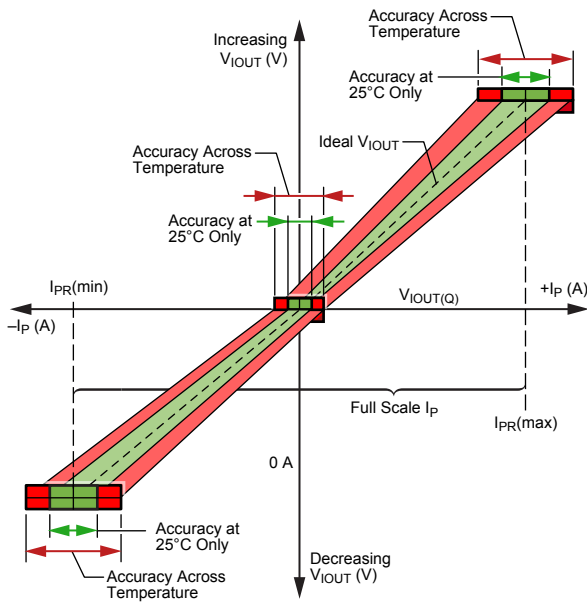

Figure 3: Output Voltage versus Sensed Current

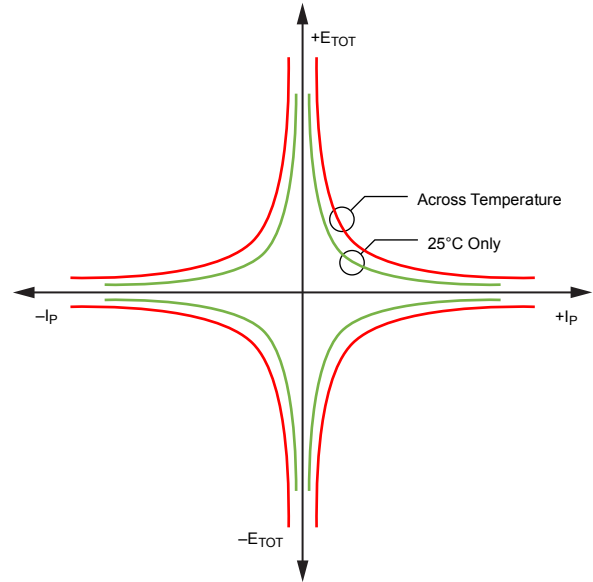

Figure 4: Total Output Error versus Sensed Current

### Definitions of Dynamic Response Characteristics

#### POWER-ON DELAY ( $t_{POD}$ )

When the supply is ramped to its operating voltage, the device requires a finite time to power its internal components before responding to an input magnetic field. Power-On Delay,  $t_{POD}$ , is defined as the time it takes for the output voltage to settle within  $\pm 10\%$  of its steady-state value under an applied magnetic field, after the power supply has reached its minimum specified operating voltage,  $V_{CC}(\text{min})$ , as shown in the chart at right.

#### RISE TIME ( $t_r$ )

The time interval between a) when the sensor reaches 10% of its full-scale value, and b) when it reaches 90% of its full-scale value.

#### PROPAGATION DELAY ( $t_{PROP}$ )

The time interval between a) when the sensed current reaches 20% of its full-scale value, and b) when the sensor output reaches 20% of its full-scale value.

#### RESPONSE TIME ( $t_{RESPONSE}$ )

The time interval between a) when the applied current reaches 90% of its final value, and b) when the sensor reaches 90% of its output corresponding to the applied current.

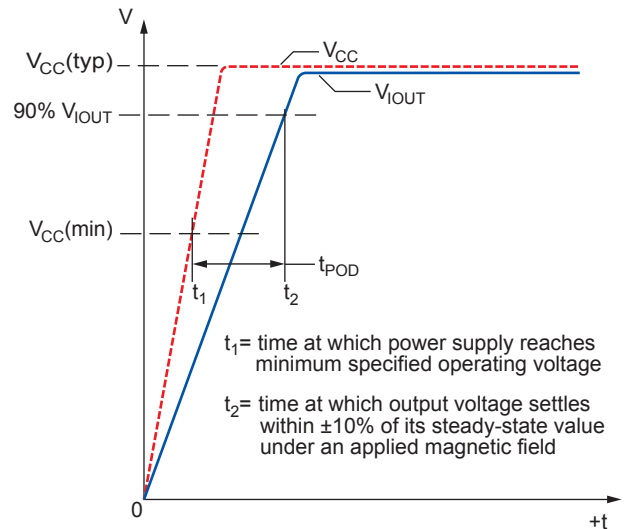

Figure 5: Power-On Delay ( $t_{POD}$ )

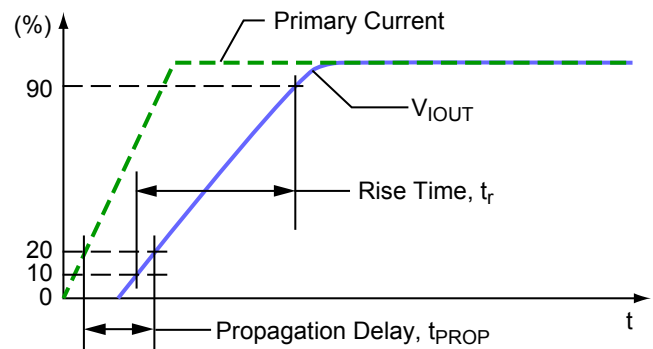

Figure 6: Rise Time ( $t_r$ ) and Propagation Delay ( $t_{PROP}$ )

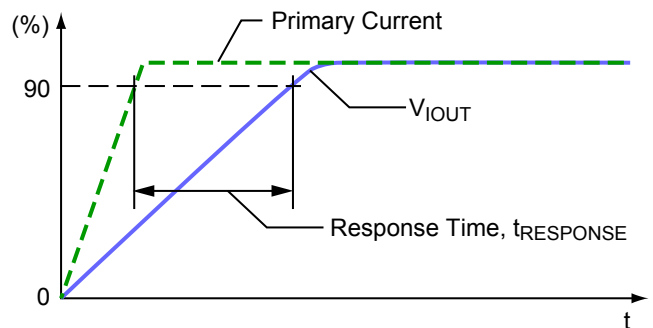

Figure 7: Response Time ( $t_{RESPONSE}$ )

## FUNCTIONAL DESCRIPTION

### Power-On Reset (POR) and Undervoltage Lockout (UVLO) Operation

The descriptions in this section assume: temperature = 25°C, no output load (RL, CL), and no significant magnetic field is present.

#### Power-Up

At power-up, as  $V_{CC}$  ramps up, the output is in a high-impedance state. When  $V_{CC}$  crosses  $V_{PORH}$  (location [1] in Figure 8 and [1'] in Figure 9), the POR Release counter starts counting for  $t_{PORR}$ . At this point, if  $V_{CC}$  exceeds  $V_{UVLOH}$  [2'], the output will go to  $V_{CC}/2$  after  $t_{UVLOD}$  [3'].

If  $V_{CC}$  does not exceed  $V_{UVLOH}$  [2], the output will stay in the high-impedance state until  $V_{CC}$  reaches  $V_{UVLOH}$  [3] and then will go to  $V_{CC}/2$  after  $t_{UVLOD}$  [4].

#### $V_{CC}$ drops below $V_{CC}(\min) = 4.5\text{ V}$

If  $V_{CC}$  drops below  $V_{UVLOL}$  [4', 5], the UVLO Enable Counter starts counting. If  $V_{CC}$  is still below  $V_{UVLOL}$  when the counter reaches  $t_{UVLOE}$ , the UVLO function will be enabled and the

output will be pulled near GND [6]. If  $V_{CC}$  exceeds  $V_{UVLOL}$  before the UVLO Enable Counter reaches  $t_{UVLOE}$  [5'], the output will continue to be  $V_{CC}/2$ .

#### Coming Out of UVLO

While UVLO is enabled [6], if  $V_{CC}$  exceeds  $V_{UVLOH}$  [7], UVLO will be disabled after  $t_{UVLOD}$ , and the output will be  $V_{CC}/2$  [8].

#### Power-Down

As  $V_{CC}$  ramps down below  $V_{UVLOL}$  [6', 9], the UVLO Enable Counter will start counting. If  $V_{CC}$  is higher than  $V_{PORL}$  when the counter reaches  $t_{UVLOE}$ , the UVLO function will be enabled and the output will be pulled near GND [10]. The output will enter a high-impedance state as  $V_{CC}$  goes below  $V_{PORL}$  [11]. If  $V_{CC}$  falls below  $V_{PORL}$  before the UVLO Enable Counter reaches  $t_{UVLOE}$ , the output will transition directly into a high-impedance state [7'].

### EEPROM Error Checking And Correction

Hamming code methodology is implemented for EEPROM checking and correction. The device has ECC enabled after power-up. If an uncorrectable error has occurred, the VOUT pin will go to high impedance and the device will not respond to applied magnetic field.

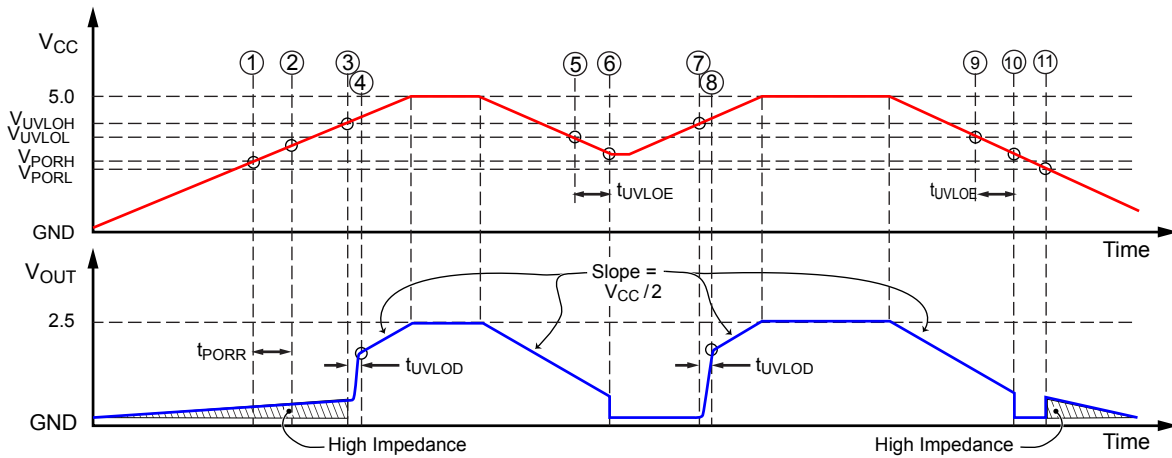

Figure 8: POR and UVLO Operation: Slow Rise Time Case

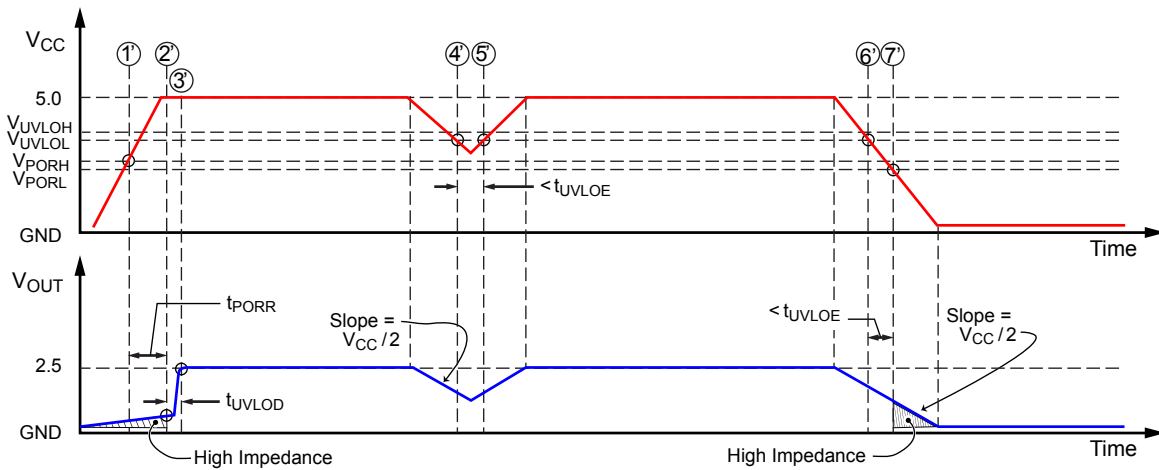

Figure 9: POR and UVLO Operation: Fast Rise Time Case

### Chopper Stabilization Technique

When using Hall-effect technology, a limiting factor for switchpoint accuracy is the small signal voltage developed across the Hall element. This voltage is disproportionately small relative to the offset that can be produced at the output of the Hall sensor IC. This makes it difficult to process the signal while maintaining an accurate, reliable output over the specified operating temperature and voltage ranges.

Chopper stabilization is a unique approach used to minimize Hall offset on the chip. Allegro employs a technique to remove key sources of the output drift induced by thermal and mechanical stresses. This offset reduction technique is based on a signal modulation-demodulation process. The undesired offset signal is separated from the magnetic field-induced signal in the frequency domain, through modulation. The subsequent demodulation acts as a modulation process for the offset, causing the magnetic field-induced signal to recover its original spectrum at baseband, while the DC offset becomes a high-frequency signal. The magnetic-

sourced signal then can pass through a low-pass filter, while the modulated DC offset is suppressed.

In addition to the removal of the thermal and stress related offset, this novel technique also reduces the amount of thermal noise in the Hall sensor IC while completely removing the modulated residue resulting from the chopper operation. The chopper stabilization technique uses a high-frequency sampling clock. For demodulation process, a sample-and-hold technique is used. This high-frequency operation allows a greater sampling rate, which results in higher accuracy and faster signal-processing capability. This approach desensitizes the chip to the effects of thermal and mechanical stresses, and produces devices that have extremely stable quiescent Hall output voltages and precise recoverability after temperature cycling. This technique is made possible through the use of a BiCMOS process, which allows the use of low-offset, low-noise amplifiers in combination with high-density logic integration and sample-and-hold circuits.

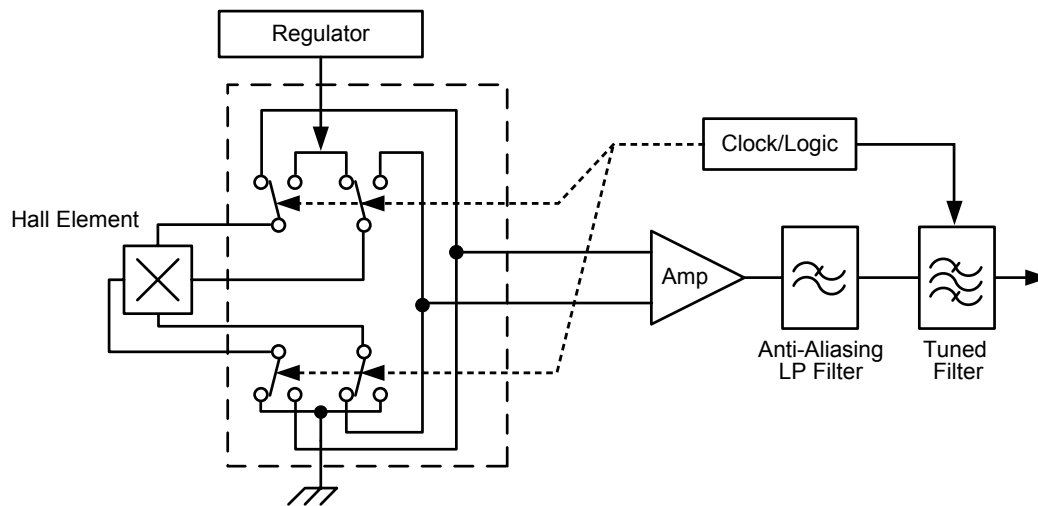

Figure 10: Concept of Chopper Stabilization Technique



### APPLICATION INFORMATION

#### Thermal Rise vs. Primary Current

Self-heating due to the flow of current should be considered during the design of any current sensing system. The sensor, printed circuit board (PCB), and contacts to the PCB will generate heat as current moves through the system.

The thermal response is highly dependent on PCB layout, copper thickness, cooling techniques, and the profile of the injected current. The current profile includes peak current, current “on-time”, and duty cycle. While the data presented in this section was collected with direct current (DC), these numbers may be used to approximate thermal response for both AC signals and current pulses.

The plot in Figure 11 shows the measured rise in steady-state die temperature of the ACS772 versus continuous current at an ambient temperature,  $T_A$ , of 25°C. The thermal offset curves may be directly applied to other values of  $T_A$ . Conversely, Figure 12 shows the maximum continuous current at a given  $T_A$ . Surges beyond the maximum current listed in Figure 12 are allowed given the maximum junction temperature,  $T_{J(MAX)}$  (165°C), is not exceeded.

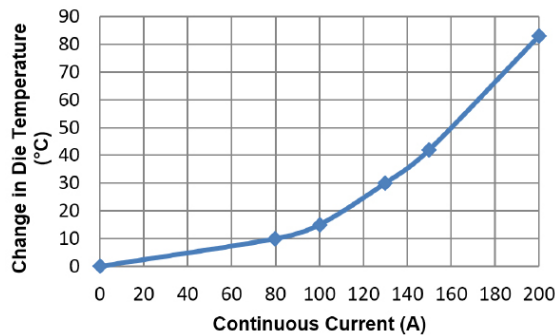

Figure 11: Self-Heating in the CB Package Due to Current Flow

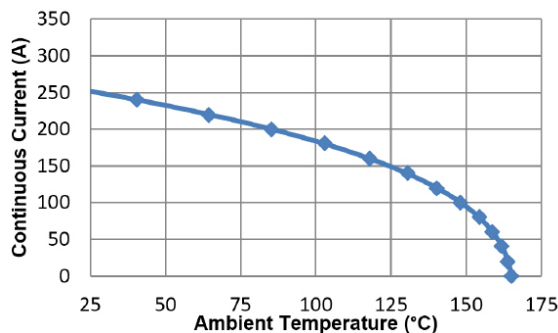

Figure 12: Maximum Continuous Current at a Given  $T_A$

The thermal capacity of the ACS772 should be verified by the end user in the application’s specific conditions. The maximum junction temperature,  $T_{J(MAX)}$  (165°C), should not be exceeded. Further information on this application testing is available in the [DC and Transient Current Capability application note](#) on the Allegro website.

#### ASEK772 Evaluation Board Layout

Thermal data shown in Figure 11 was collected using the ASEK772 Evaluation Board (TED-85-0385-001). This board includes 2664 mm<sup>2</sup> of 4 oz. copper (0.1388 mm) connected to pins 4 and 5 with thermal vias connecting the layers. Top and bottom layers of the PCB are shown below in Figure 13.

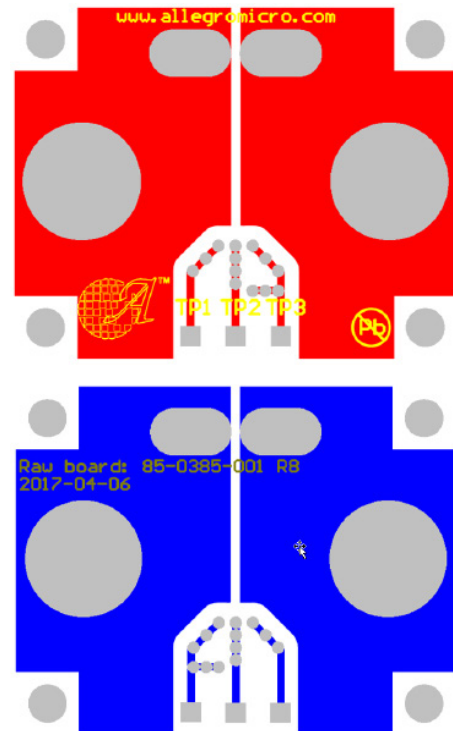

Figure 13: Top and Bottom Layers for ASEK772 Evaluation Board

Gerber files for the ASEK772 evaluation board are available for download from the Allegro website. See the technical documents section of the [ACS772 device webpage](#).

### PACKAGE OUTLINE DRAWING

#### For Reference Only – Not for Tooling Use

(Reference DWG-9111 & DWG-9110)  
Dimensions in millimeters – NOT TO SCALE  
Dimensions exclusive of mold flash, gate burs, and dambar protrusions  
Exact case and lead configuration at supplier discretion within limits shown

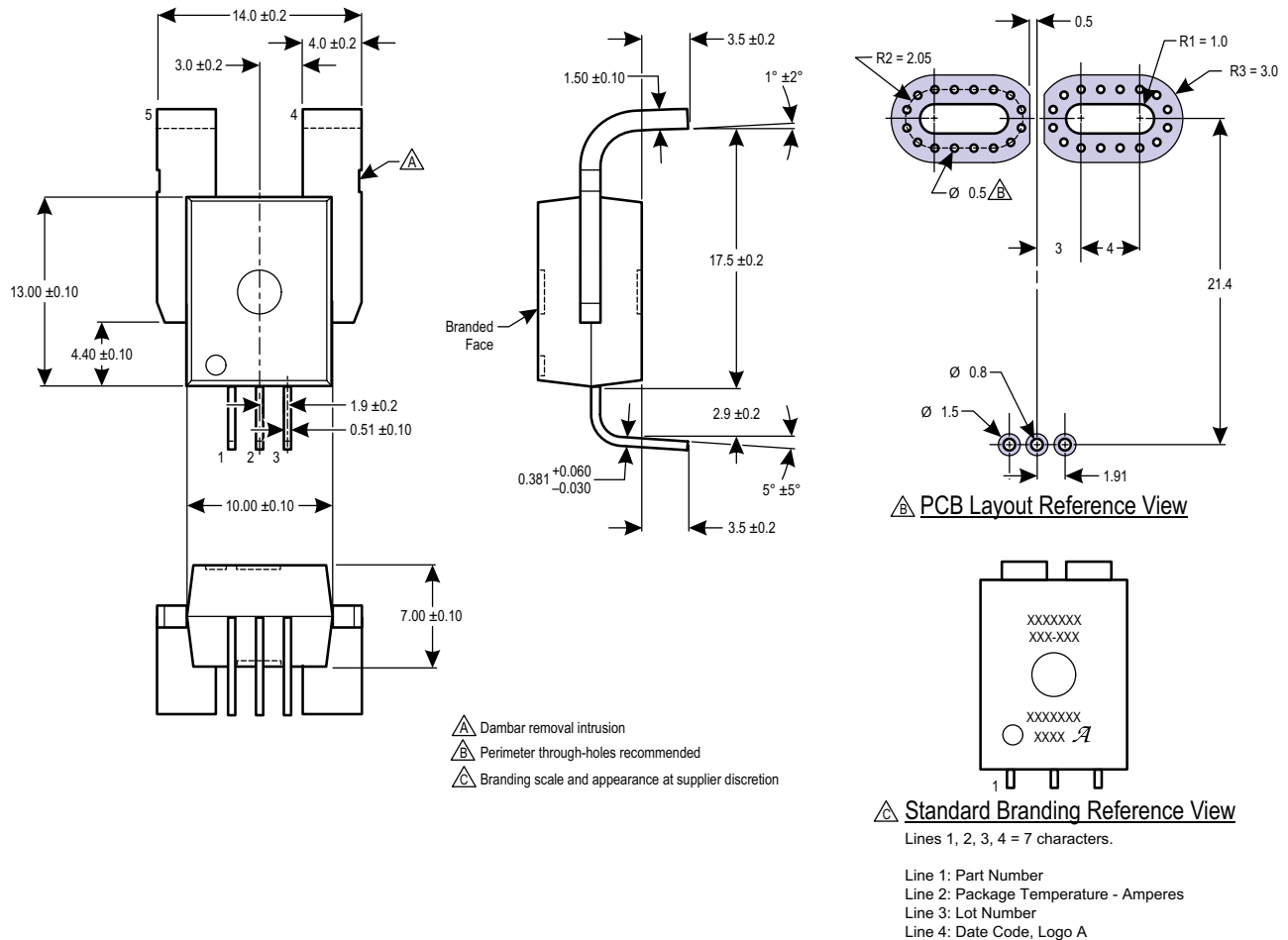

Creepage distance, current terminals to signal pins: 7.25 mm  
Clearance distance, current terminals to signal pins: 7.25 mm  
Package mass: 4.63 g typical

Figure 14: Package CB, 5-Pin, Leadform PFF

### For Reference Only – Not for Tooling Use

(Reference DWG-9111, DWG-9110)  
Dimensions in millimeters – NOT TO SCALE  
Dimensions exclusive of mold flash, gate burs, and dambar protrusions  
Exact case and lead configuration at supplier discretion within limits shown

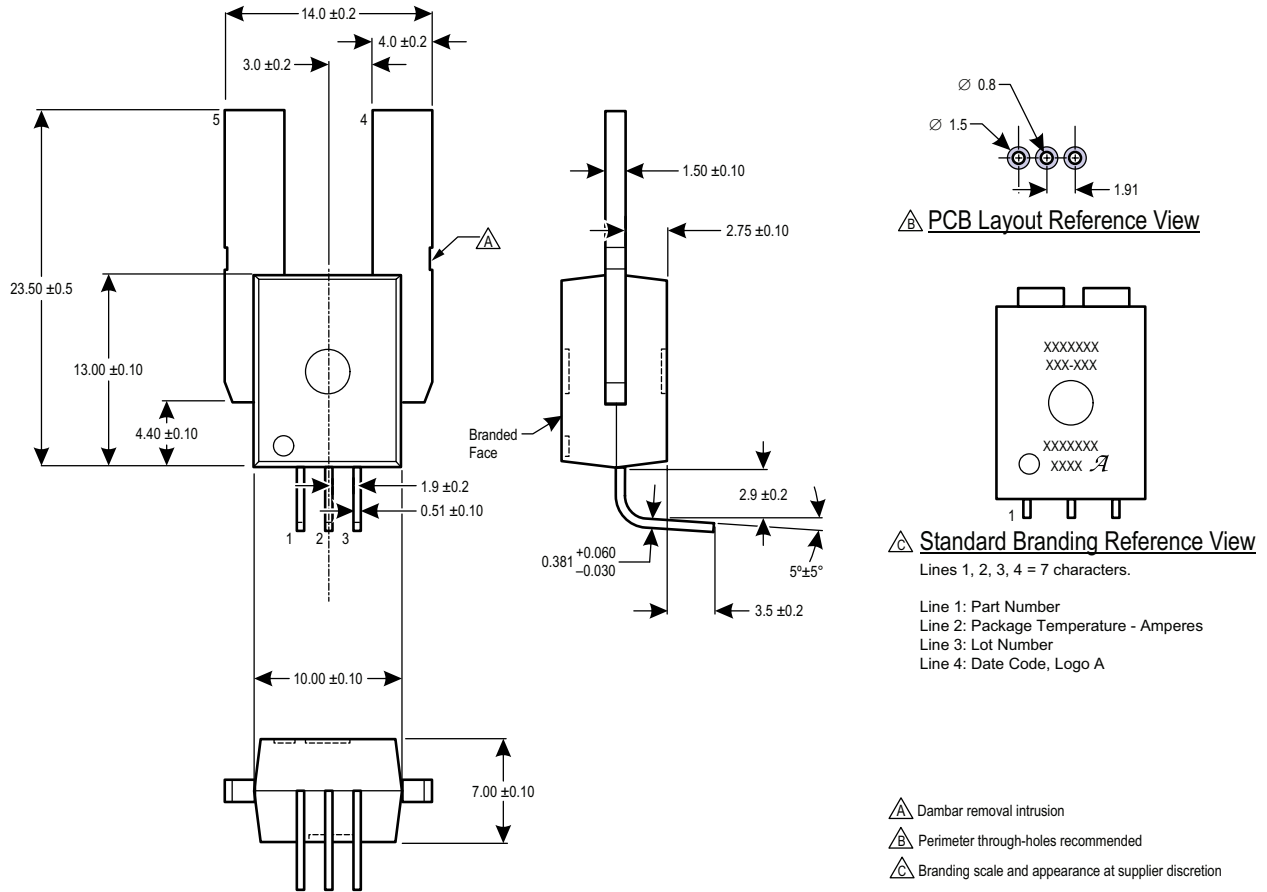

Figure 15: Package CB, 5-Pin, Leadform PSF

### For Reference Only – Not for Tooling Use

(Reference DWG-9111, DWG-9110)  
Dimensions in millimeters – NOT TO SCALE  
Dimensions exclusive of mold flash, gate burs, and dambar protrusions  
Exact case and lead configuration at supplier discretion within limits shown

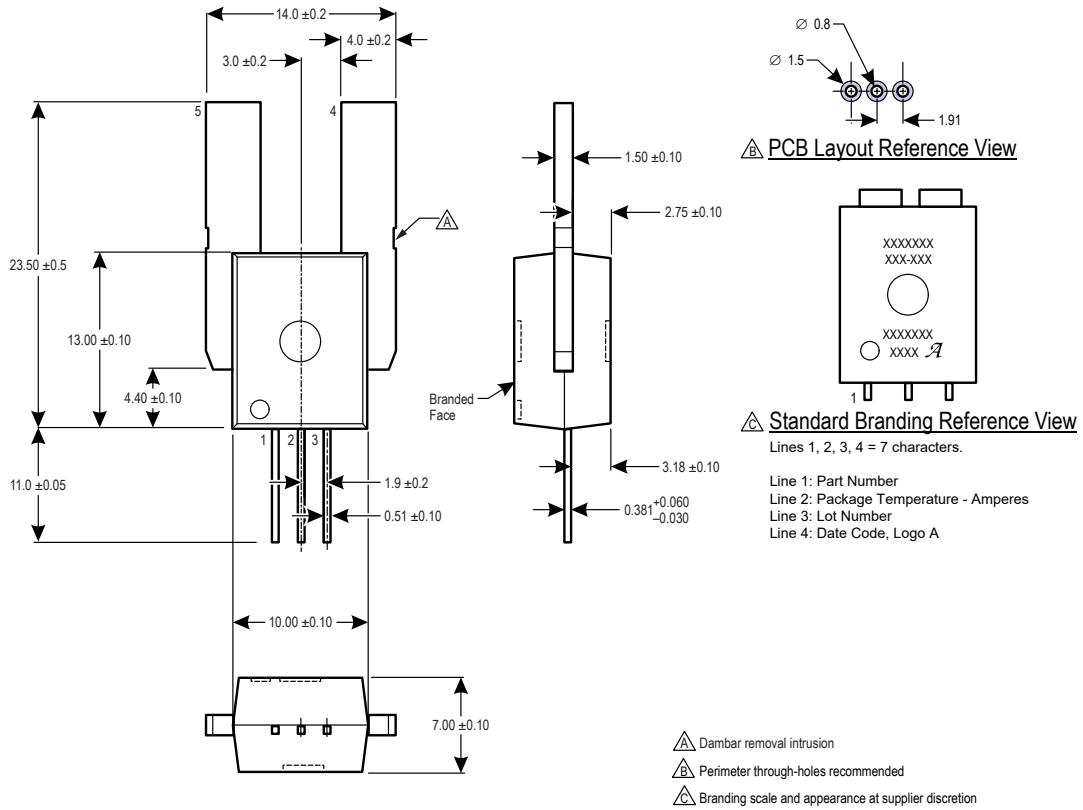
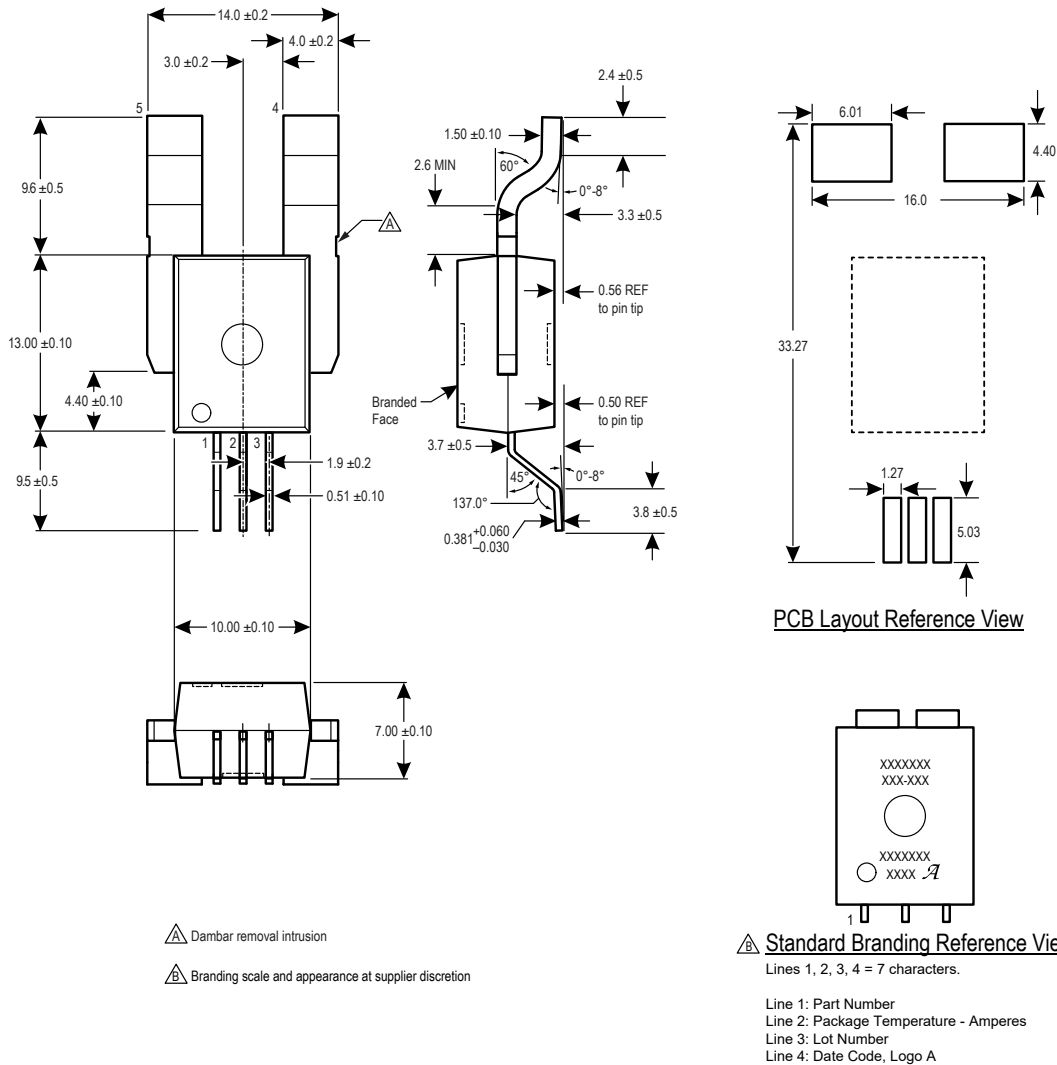

Figure 16: Package CB, 5-Pin, Leadform PSS

### For Reference Only – Not for Tooling Use

(Reference DWG-9111, DWG-9110)  
Dimensions in millimeters – NOT TO SCALE  
Dimensions exclusive of mold flash, gate burrs, and dambar protrusions  
Exact case and lead configuration at supplier discretion within limits shown



**Figure 17: Package CB, 5-Pin, Leadform SMT**

Note: The SMT leadform package variant is considered Advance Information, and is subject to change without notice.