

ACT86600EVK1-101 User's Guide

Description

This document describes the characteristics and operation of the Qorvo ACT86600EVK1-101 evaluation kit (EVK). It provides setup and operation instructions, schematic, layout, BOM, and test data. This EVK demonstrates the ACT86600QM101 ActivePMU power management IC. Other ACT86600QMxxx options can be evaluated on this EVK by replacing the IC and any other necessary components.

Features

The EVK can be used as a standalone board if desired. However, to access the internal registers and to take full advantage of the IC's capability, the user must connect the EVK kit to a PC with Qorvo's USB-TO-I2C interface dongle and use the GUI software. The EVK provides full access to the each converter's input and output voltage, as well as all the digital control signals. This gives the user the flexibility to configure the EVK to match their real-world system.

Note that the ACT86600EVK1-101 is specifically configured for the ACT86600QM101.



Figure 1 – EVK Picture

EVK Contents

The ACT86600EVK1-101 evaluation kit comes with the following items:

1. EVK assembly
2. USB-TO-I2C dongle
 - a. Dongle
 - b. Custom 4-pin connector that connects the USB-TO-I2C dongle to the EVK assembly

Required Equipment

ACT86600EVK1-101

USB-TO-I2C Dongle

Power supply – 12V @ 7.5A or 5V @ 18A for full power operation

Oscilloscope – >100MHz, 4 channels

Loads – Electronic or resistive. 8.0A minimum current capability.

Digital Multimeters (DMM)

Windows compatible computer with spare USB port.

Hardware Setup

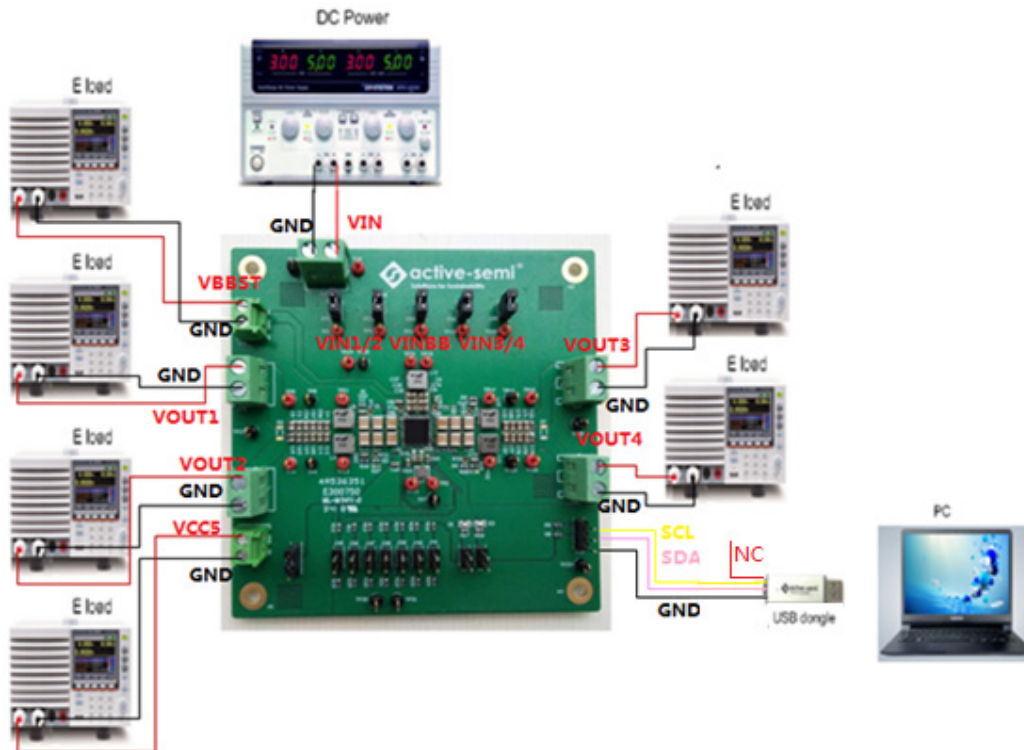

Figure 2 – EVK Setup

Innovative Power™

ActiveSwitcher™ is a trademark of Qorvo.

In the figure above,

VIN is input voltage to the EVK.

VIN1 is input voltage to BUCK1 and VOUT1 is the output voltage.

VIN2 is input voltage to BUCK2 and VOUT2 is the output voltage.

VIN3 is input voltage to BUCK3 and VOUT3 is the output voltage.

VIN4 is input voltage to BUCK4 and VOUT4 is the output voltage.

VINBB is input voltage to BUCK-BOOST and VBBST is the output voltage.

VCC5 is the IC's 5.0V output

GND is the PCB's common ground plane.

Quick Start

Hardware Setup

1. Decide which voltage will power VIO. Qorvo recommends powering VIO from the VCC5 output for general evaluation. Install a shorting jumper between J1-1 and J1-2 to power VIO from VCC5. Or use a wire to connect J1-2 to any Buck converter output.
2. Connect a lab supply between J20-1 and J20-2 to power VIN.
3. Install a shorting jumper on J22, J23, J26, J28, and J30 to power each switching converter from the same lab supply as VIN. If a switching converter needs to be powered from a different input voltage, remove the shorting jumper and connect that converters input to a different lab supply.
 - a. J22-1 powers VIN1.
 - b. J23-1 powers VIN2.
 - c. J26-1 powers VIN3.
 - d. J28-1 powers VIN4.
 - e. J30-1 powers VINBB.
4. Connect an appropriate load to each power supply output.
5. Note that the typical setup is to apply the same 12V input voltage to all inputs. VIN1/2/3/4 and VINBB are connected to VIN by jumpers. When 12V input voltage is applied to VIN, input voltages of VIN1/2/3/4 and VINBB will be 12V. Using different input voltage sources requires careful consideration of startup sequencing. Each buck regulator may be connected to its own power input and it is not mandatory to connect all regulator inputs to the same input power supply.
6. Turn on the lab supplies, and the outputs turn on and sequence up automatically.

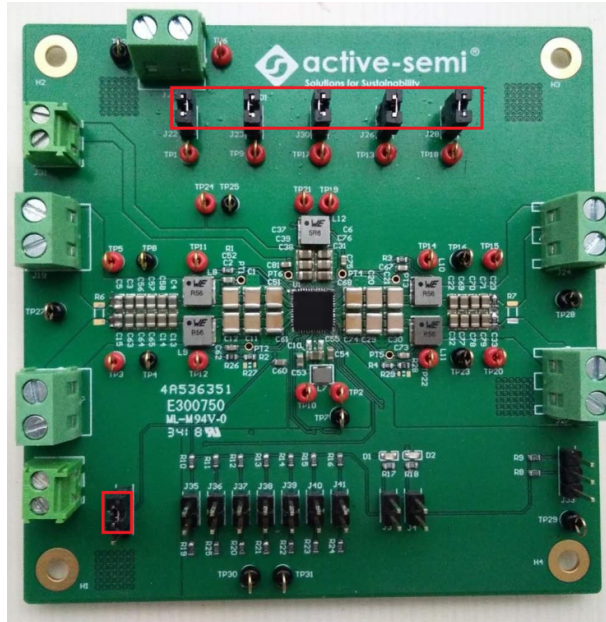

Figure 3 – Default Jumper Settings (VIO=VCC5)

GUI Setup (optional)

1. Refer to the GUI installation guide for detailed instructions to install the ACT86600 GUI.
2. Connect the USB-TO-I2C dongle to the computer via a USB cable.
3. Connect the USB-TO-I2C dongle to the EVK J33 connector (notice that nIRQ pin of dongle is not connected). Refer to Figure 4 to ensure the correct polarity of the connection. As a guide, use the “Qorvo” logo (or “Active-Semi” logo) on the top of the dongle so the black wire is connected to the Dongle GND pin.

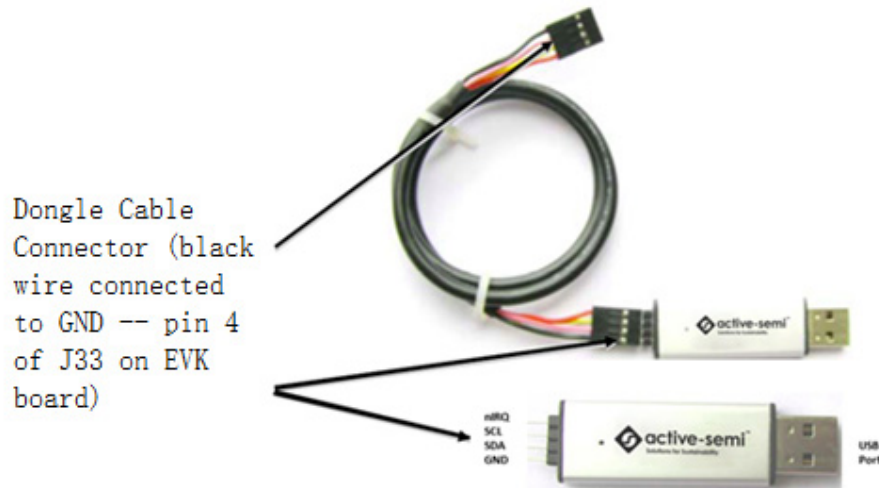

Figure 4 – USB-TO-I2C Dongle Connection

EVK Design Parameters

The recommended input voltage for ACT86600EVK1-101 is 5.0V to 12V. The PMIC has separate input pins for each buck regulator and buck-boost regulator. The input voltage can be in the range of 2.7V to 14.4V. The maximum operating voltage is determined by the IC’s maximum input voltage rating. The minimum operating voltages are determined by the converters’ minimum input voltage. Maximum currents are determined by the IC’s CMI settings, which can be changed via I2C after startup. Maximum rated current of buck-boost is dependent on input and output voltages of buck-boost.

Table 1. EVK Design Parameters

Parameter	Description	Min	Typ	Max	Unit
AVIN	System input voltage (VCC5 regulator input voltage)	2.7		18	V
VIN1/2/3/4,VINBB	All buck and buck-boost input voltages	2.7		14.4	V
I _{B1_max}	Maximum Buck 1 DC load current		6.0		A
I _{B2_max}	Maximum Buck 2 DC load current		6.0		A
I _{B3_max}	Maximum Buck 3 DC load current		4.0		A
I _{B4_max}	Maximum Buck 4 DC load current		4.0		A
I _{BB_max}	Maximum Buck-boost DC load current		0.6		A
I _{vcc5}	Maximum VCC5 DC load current		0.5		A

EVK Operation

Turn On

Apply the 12V input voltage. All outputs automatically turn on with the programmed startup sequence.

Sleep Mode

Enter Sleep Mode by changing voltage level of GPIO4 from low to high. In Sleep Mode, the BUCK1/2/3 are still on, meanwhile BUCK4 and BUCK-BOOST outputs turn off. This is the default EVK sleep setting. However the sleep/deep sleep settings are configurable.

Schematic

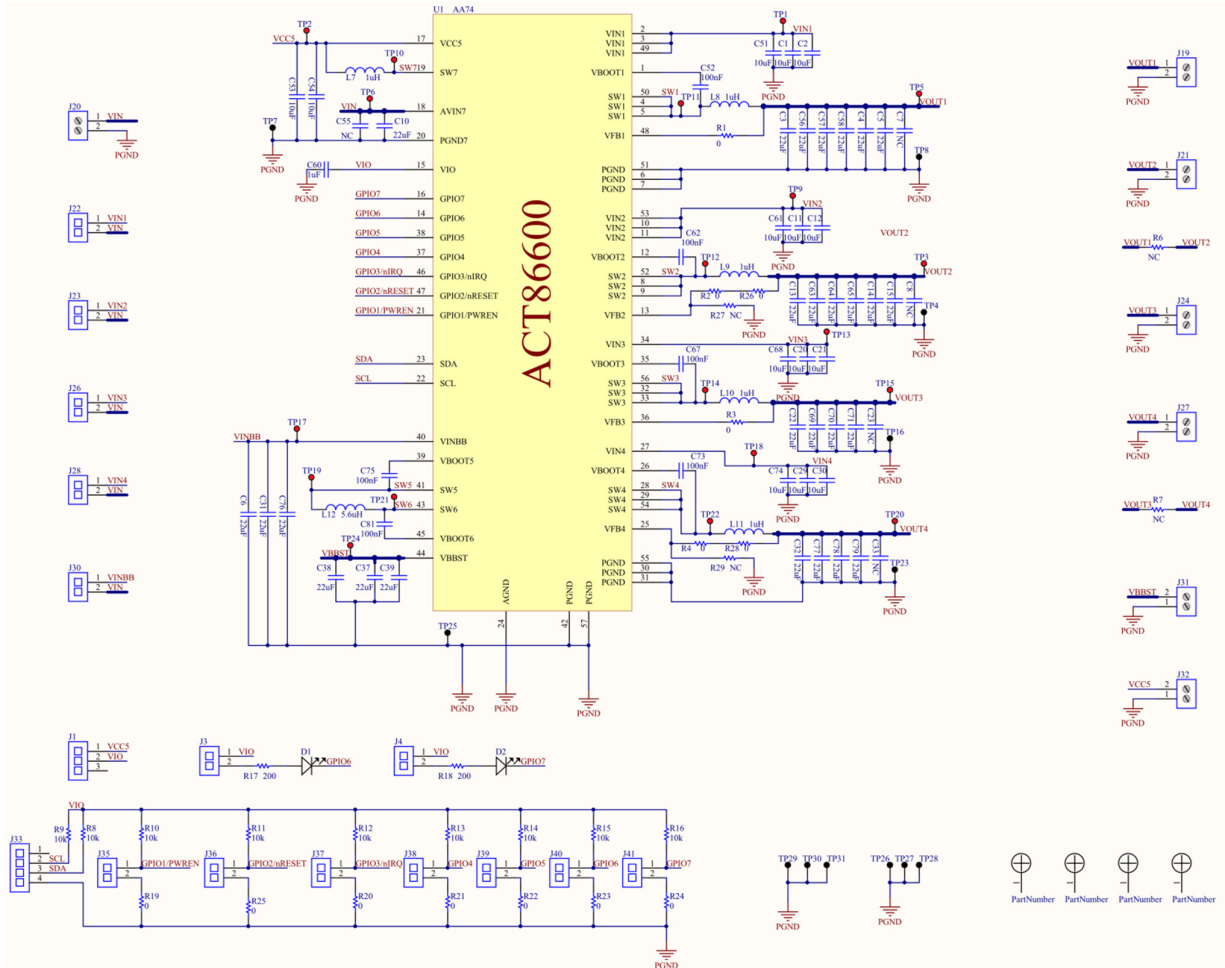

Figure 5 – ACT86600EVK1-101 Schematic

Layout

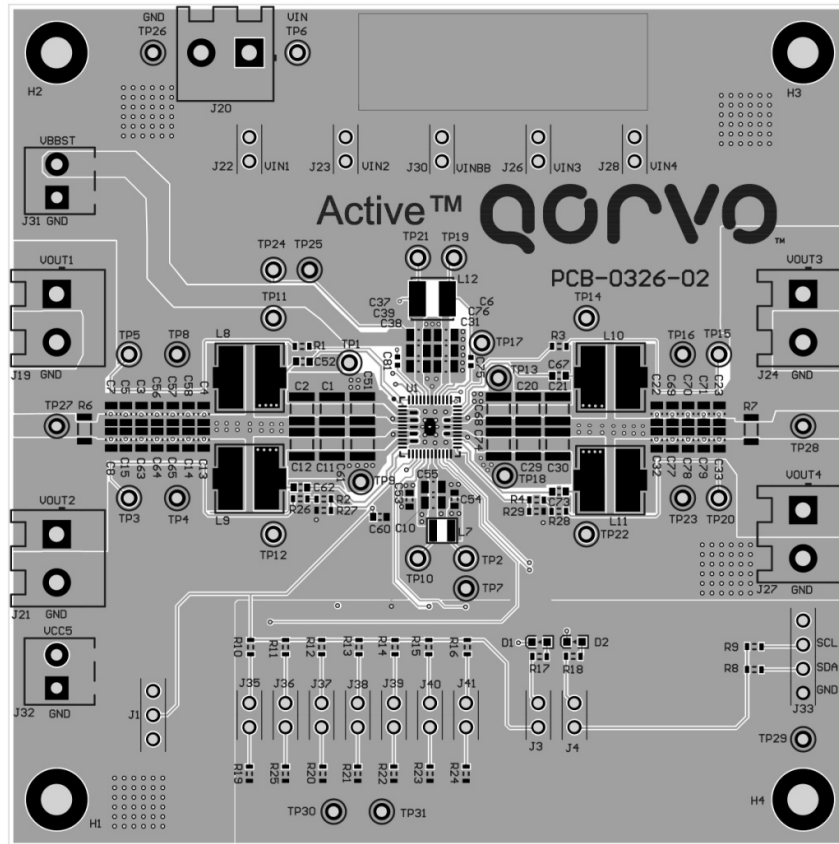

Figure 6 – Layout Top Assembly

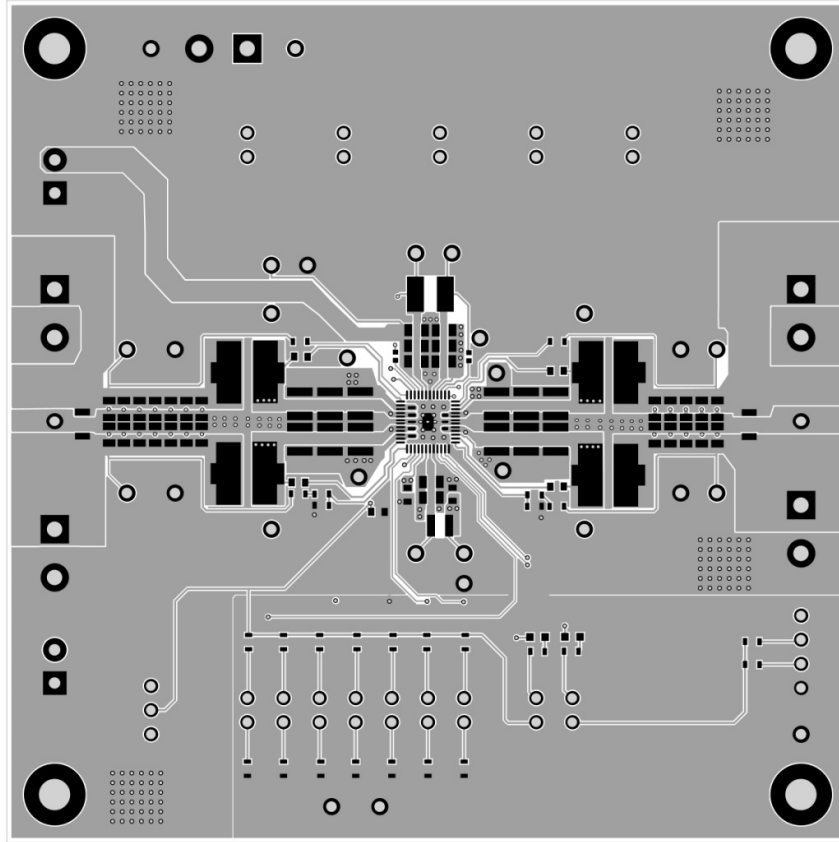

Figure 7 – Layout Top Layer

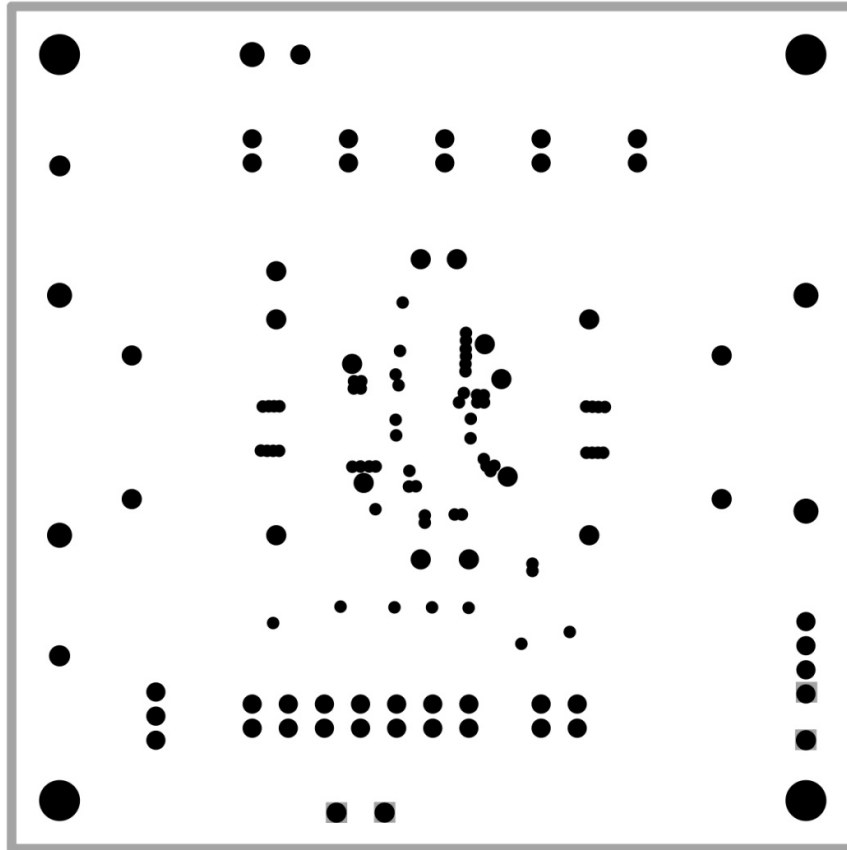

Figure 8 – Layout Layer 2 (internal GND plane)

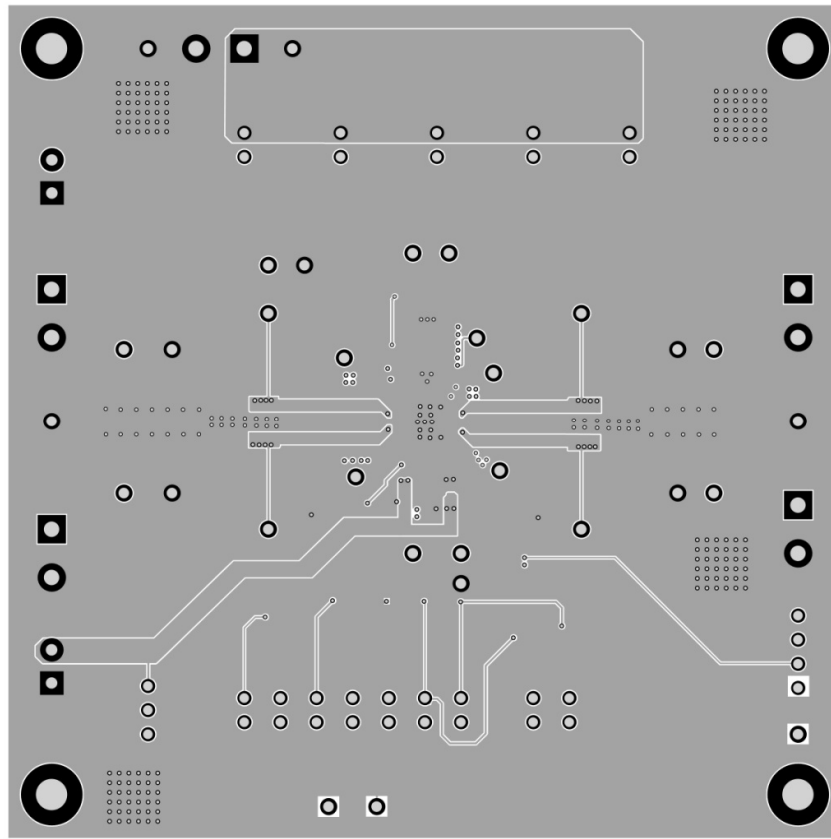

Figure 9 – Layout Layer 3

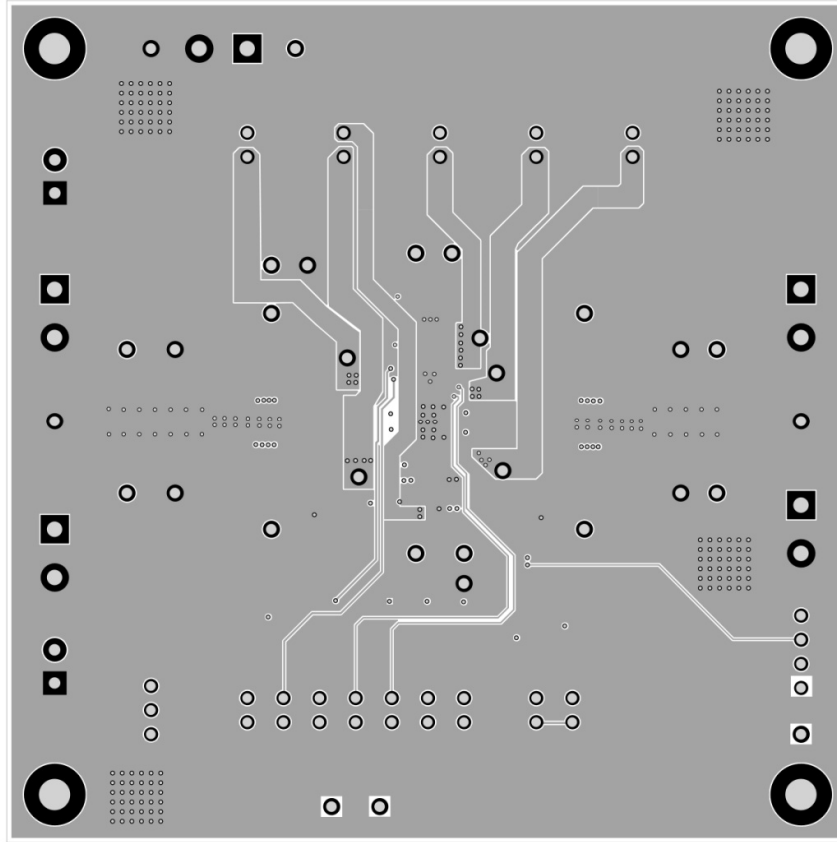

Figure 10 – Layout Bottom Layer

Bill of Materials
Table 2 - BOM

Item	Ref Des	QTY	Description	Package	MFR	Part Number	Note
1	C1, C2, C11, C12, C20, C21, C29, C30, C51, C61, C68, C74	12	Capacitor, Ceramic, 10uF, 16V, 10%, X7R	1210	WURTH	885012209014	
2	C4, C13, C22, C32, C56, C57, C58, C14, C64, C65, C69, C70, C77, C78, C3, C5, C63, C15, C71, C79, C6, C10, C31, C37, C38, C39, C76	27	Capacitor, Ceramic, 22uF, 25V, 20%, X5R	0805	Samsung	CL21A226MAQNNNE	
3	C23, C33, C55, C7, C8	0	Capacitor, Ceramic, 22uF, 25V, 20%, X5R	0805	Samsung	CL21A226MAQNNNE	NC
4	C52, C62, C67, C73	4	Capacitor, Ceramic, 100nF, 16V, 20%, X5R	0603	Standard	Standard	
5	C53, C54	2	Capacitor, Ceramic, 10uF, 16V, 20%, X5R	0603	Standard	Standard	
6	C60	1	Capacitor, Ceramic, 1uF, 16V, 20%, X5R	0603	Standard	Standard	
7	C75, C81	2	Capacitor, Ceramic, 100nF, 16V, 20%, X5R	0402	Standard	Standard	
8	D1, D2	2	Led, Blue	0603	Standard	Standard	
9	J1, J33	2	Header, Unshrouded, 2.54 mm, Male, 3P	con, hdr, 254-3p	Standard	Standard	
10	J3, J4, J22, J23, J26, J28, J30, J35, J36, J37, J38, J39, J40, J41	14	Header, Unshrouded, 2.54 mm, Male, 2P	con, hdr, 254-2p	Standard	Standard	
11	J19, J20, J21, J24, J27	5	Connector, Screw Terminal, 5.08 mm, 2P	con, tbk, 508-2p, molex-0395443002	WURTH	691213710002	
12	J31, J32	2	Connector, Screw Terminal, 3.50 mm, 2P	con, tbk, 350-2p, kf350	Standard	Standard	
13	R1, R2, R3, R4	4	Resistor, 0ohm, 1%	0603	Standard	Standard	
14	R6, R7	0	Resistor, 0ohm, 1%	1206	Standard	Standard	NC
15	R8, R9, R10, R11, R12, R13, R14, R15, R16	9	Resistor, 10k, 5%	0603	Standard	Standard	
16	R17, R18	2	Resistor, 200, 5%	0603	Standard	Standard	
17	R19, R20, R21, R22, R23, R24, R25, R26, R28	9	Resistor, 0ohm, 1%	0603	Standard	Standard	
18	R27, R29	0	Resistor, 0ohm, 1%	0603	Standard	Standard	NC
19	U1	1	IC, Integrated High Voltage PMIC	QFN48 6x6	Qorvo	ACT86600QM101	
20	L7	1	Inductor, 1uH, 2.8A, 60mΩ	2512	WURTH	74438324010	
21	L8, L9, L10, L11	4	Inductor, 1uH, 7.2A, 15mΩ	4020	WURTH	74438356010	
22	L12	1	Inductor, 5.6uH, 3.6A, 51mΩ	4030	WURTH	74438357056	
23	TP1, TP2, TP3, TP5, TP6, TP9, TP10, TP11, TP12, TP13, TP14, TP15, TP17, TP18, TP19, TP20, TP21, TP22, TP24	19	Test point, 0.050 hole, red	Keystone-5000	Keystone	keystone-5000	
24	TP4, TP7, TP8, TP16, TP23, TP25, TP26, TP27, TP28, TP29, TP30, TP31	12	Test point, 0.050 hole, black	tpt, Keystone-5001	Keystone	keystone-5001	

25	N/A	6	Shunt, 2.54 mm	N/A	Standard	Standard	Jumpers at J22/J23/J30/J26/J28; at J1 (between pin1 and pin2)
26	N/A	1	PCB, 4-Layer FR4, 90*90*1mm	N/A	Shanghai Fast-pcb Tech.Co, Ltd	PCB-0326-02	

GUI Installation

1. Contact Qorvo for the GUI files and save them on your computer.
2. Plug the USB-TO-I2C dongle into a free USB port.
3. Follow the instructions in the “Qorvo's GUI and Dongle Driver Installation Rev1.1.pdf” file.

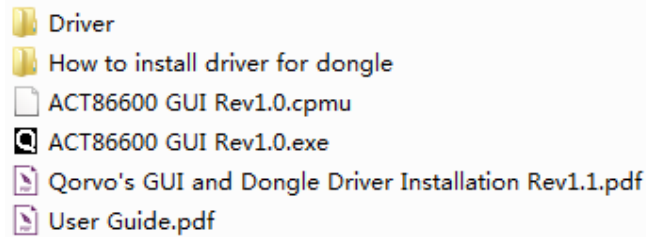

Figure 11 – Dongle Driver

4. Double click on the ACT86600 GUI Rev1.0.exe to start the ACT86600 GUI.

GUI Overview

The GUI has 4 basic function buttons allocated in top-left of the Tool Bar which are used to open and save ACT86600’s register information data (.iact or.xml files), to read and write using I²C. The GUI contains 2 setting modes: Basic Mode and Advanced Mode. In Basic Mode screen it displays basic user programmable configuration options that can be modified using the drop-down boxes or check boxes. Advanced Mode contains the button text for changing setting for every single register or register bit.

Basic Mode

The following figure shows the GUI in basic mode. This mode allows the user to easily change one or more IC settings.

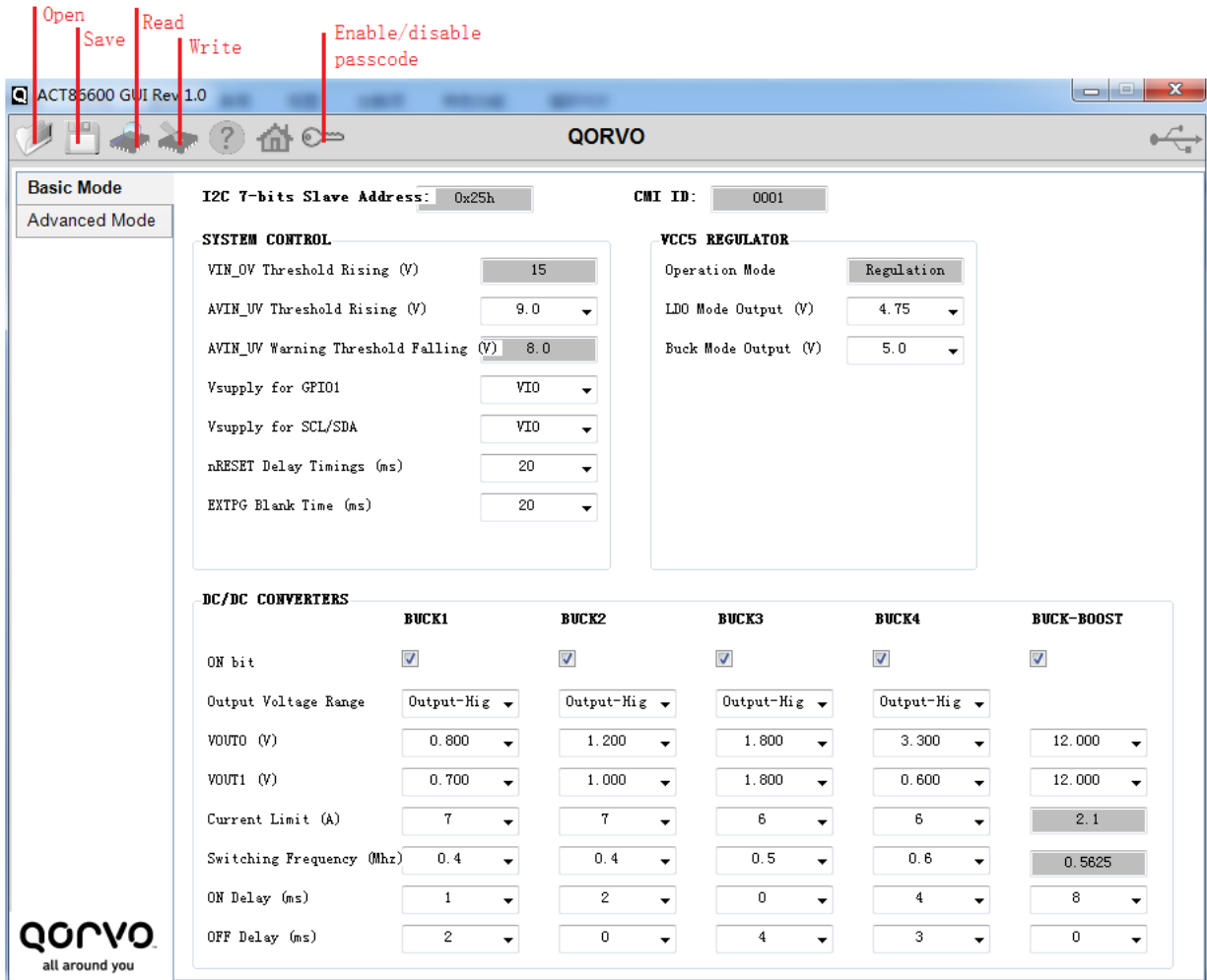

Figure 12 – GUI Basic Mode

Advanced Mode

Click the “Advanced Mode” button in the left of the GUI screen to see all available user programmable I²C registers. With Advanced Mode, additional user programmable features can be selected using the toggle button and the Advanced Mode is useful for identifying individual register bit functions. In the left side of the Advanced Mode Screen, click on the Tiles Selector to display the register by functional block (tile) to view or change register settings. Then change a register one bit at a time by clicking on the desired bit. The value of the bit is display right next to the bit-name button.

Note that the far right side of the screen contains a scroll down button to scroll down to additional registers since the Tile Screen can only display up to 8 bytes at once.

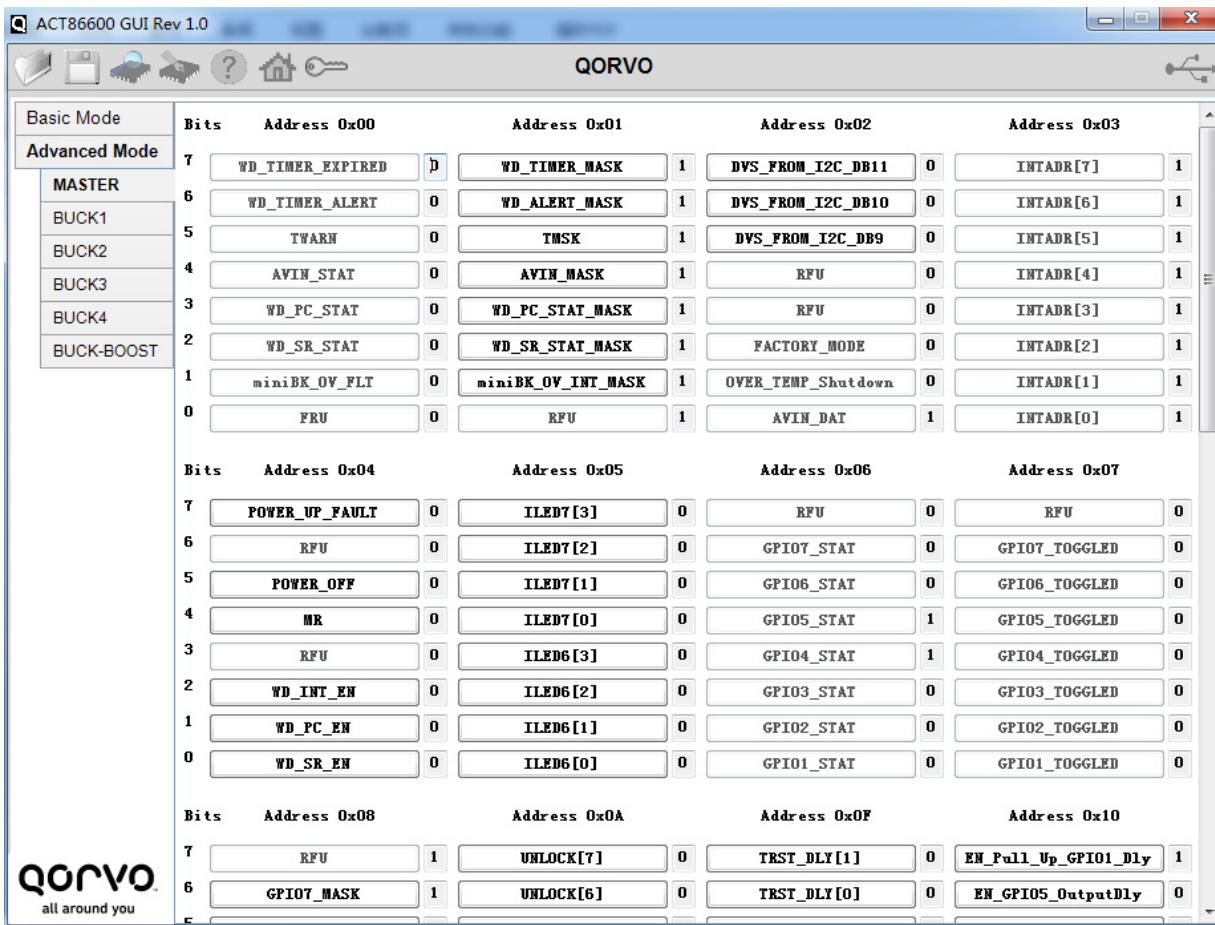

Figure 13 – GUI Advanced Mode

Button Descriptions

OPEN: Open function allows the user to open an ACT86600’s register information data from a saved file (.iact or.xml files). The file should be either provided by Qorvo or saved by the same software previously.

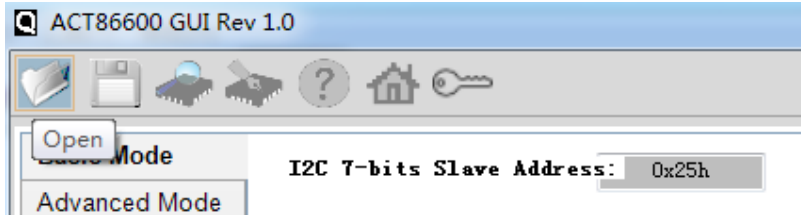

Figure 14 – Open Button

Save: Save function allows the user to save the ACT86600 register information to an .iact or .xml file. Qorvo recommends user to save the register information to an .iact file.

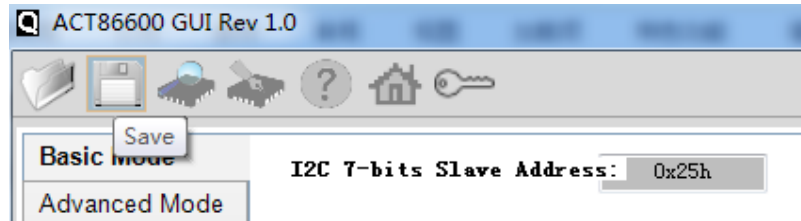

Figure 15 – Save Button

Read: Clicking on this button reads the ACT86600 registers and displays the values in the GUI. Note that this button reads all registers. Qorvo recommends reading registers each time the ACT86600 powers-up to acquire the initial programmed register settings. Qorvo also recommends reading registers after making changes to them. Immediately reading the registers after a write confirms the changes were properly stored. This also updates the MASTER STATUS box to ensure that one of the changes did not generate a fault condition.

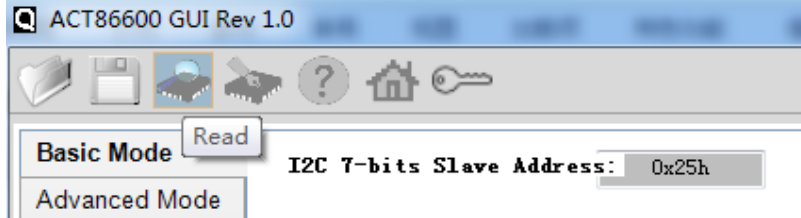

Figure 16 – Read Button

Write: Clicking on this button writes the GUI settings to the ACT86600's registers. All registers are written, regardless of whether or not they were changed.

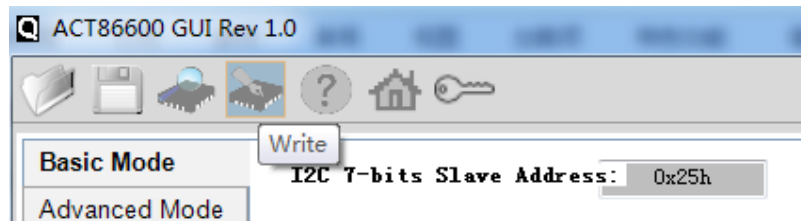

Figure 17 – Write Button

Write-Protected Disable

The GUI starts default with write protect disabled, meaning the GUI will write the passcode command automatically prior to writing any register(s). This is “passcode enabled” mode of the GUI when the icon displays as below figure.



Figure 18 – Passcode Enable

Write-Protected Enable

Customer can click on the passcode icon to enable the “I²C Write Protect”. After that, the icon will switch to “Lock”. In this Write-Protected mode, the GUI will write standard single byte I²C, without writing the passcode automatically. The register information cannot be updated without the correct passcode.



Figure 19 – Passcode Disable

Dongle Connection Status: The GUI also contains a dongle is connected status which indicates that Qorvo’s USB-TO-I2C dongle is connected to the USB port of the driver installed. The figures below show the possible indication status graphics.

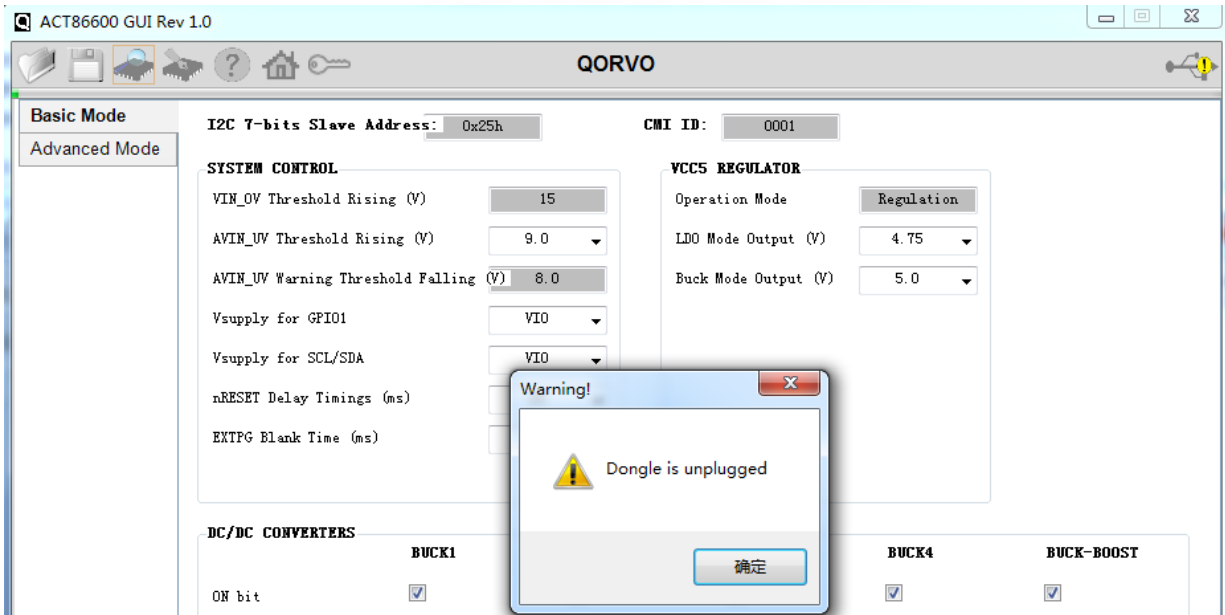

Figure 20 – Dongle is not connected to PC/GUI software