

ACZRC5340B-G Thru. ACZRC5388B-G

Voltage: 6.0 to 200 Volts

Power: 5 Watts

RoHS Device

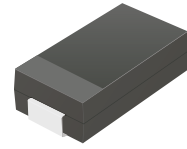

Features

- Glass passivated chip.
- Low leakage.
- Built-in strain relief.
- Low inductance.
- High peak reverse power dissipation.
- For use in stabilizing and clipping circuits with high power.
- Comply with AEC-Q101

Mechanical data

- Case: DO-214AB(SMC), Molded plastic.
- Epoxy: UL 94V-0 rate flame retardant.
- Terminals: Solderable per MIL-STD-750 ,method 2026 guranteed.
- Polarity: Color band denotes cathode end.
- Mounting position: Any.
- Weight: 0.230 gram (approx.)

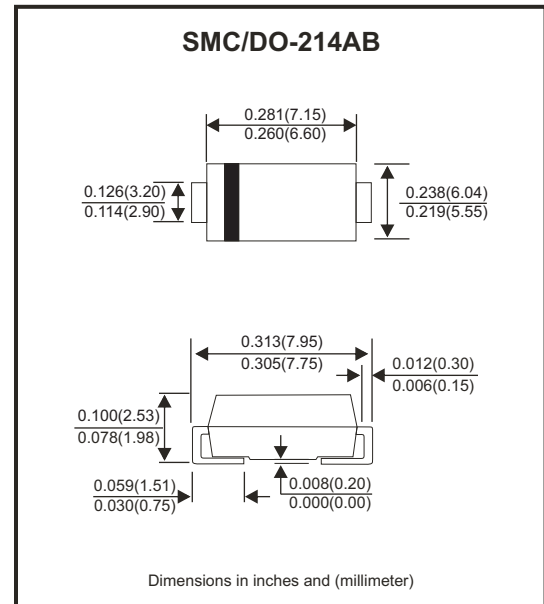

Circuit diagram



Maximum Ratings (TA=25°C unless otherwise noted)

Parameter	Symbol	Value	Units
DC power dissipation at T _L = 75°C (Note1)	P _D	5	W
Maximun forward voltage at I _F =1A	V _F	1.2	V
Junction temperature range	T _J	-55 to +150	°C
Storage temperature range	T _{STG}	-55 to +150	°C

Note:

(1) Mounted on 5.0mm² (1oz thick) land areas, lead temperature at T_L=75°C.

RATING AND CHARACTERISTIC CURVES (ACZRC5340B-G Thru. ACZRC5388B-G)

Fig.1 - Power temperature derating current

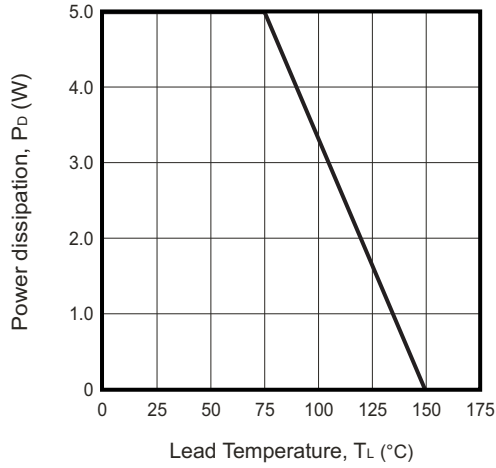

Fig.2 - Temperature coefficients v.s. Zener voltage

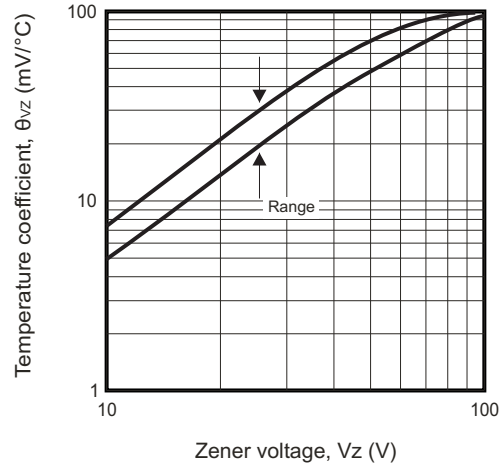

Fig.3 - Typical thermal resistance v.s. lead length

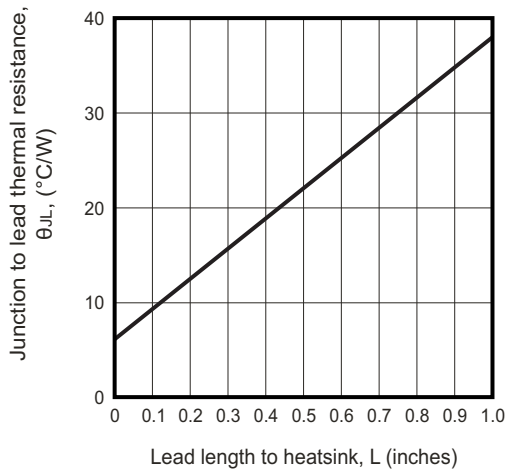

Fig.4 - Maximum surge power

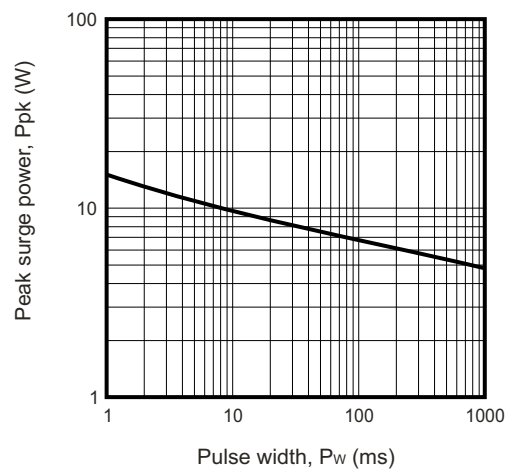
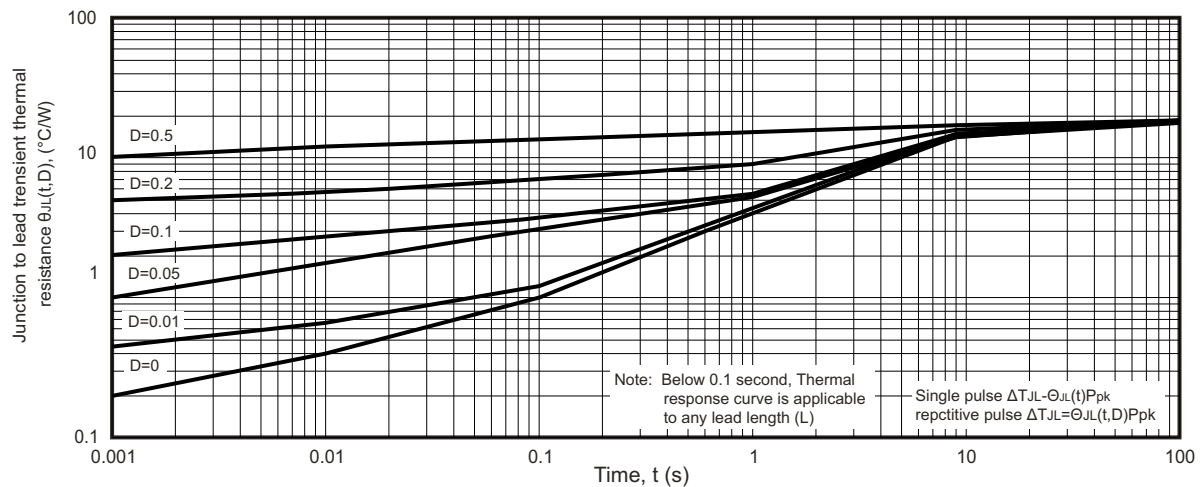

Fig.5- Typical thermal response L , lead length=3/8 inch



Company reserves the right to improve product design, functions and reliability without notice.

Electrical Characteristics (at TA=25°C unless otherwise specified)

Part Number	Nominal Zener Voltage		Maximum Zener Impedance			Maximum Reverse Leakage Current		Maximum DC Zener Current	Marking Code
	Vz @ IzT	IzT	ZzT @ IzT	Zzk @ Izk	Izk	Ir @ VR		IzM	
	(V)	(mA)	(Ohm)	(Ohm)	(mA)	(uA)	(V)	(mA)	
ACZRC5340B-G	6.0	200	1.0	300	1	1.0	3.0	790.0	340B
ACZRC5341B-G	6.2	200	1.0	200	1	1.0	3.0	765.0	341B
ACZRC5342B-G	6.8	175	1.0	200	1	10.0	5.2	700.0	342B
ACZRC5343B-G	7.5	175	1.5	200	1	10.0	5.7	630.0	343B
ACZRC5344B-G	8.2	150	1.5	200	1	10.0	6.2	580.0	344B
ACZRC5345B-G	8.7	150	2.0	200	1	10.0	6.6	545.0	345B
ACZRC5346B-G	9.1	150	2.0	150	1	7.5	6.9	520.0	346B
ACZRC5347B-G	10.0	125	2.0	125	1	5.0	7.6	475.0	347B
ACZRC5348B-G	11.0	125	2.5	125	1	5.0	8.4	430.0	348B
ACZRC5349B-G	12.0	100	2.5	125	1	2.0	9.1	395.0	349B
ACZRC5350B-G	13.0	100	2.5	100	1	1.0	9.9	365.0	350B
ACZRC5351B-G	14.0	100	2.5	75	1	1.0	10.6	340.0	351B
ACZRC5352B-G	15.0	75	2.5	75	1	1.0	11.5	315.0	352B
ACZRC5353B-G	16.0	75	2.5	75	1	1.0	12.2	295.0	353B
ACZRC5354B-G	17.0	70	2.5	75	1	0.5	12.9	280.0	354B
ACZRC5355B-G	18.0	65	2.5	75	1	0.5	13.7	265.0	355B
ACZRC5356B-G	19.0	65	3.0	75	1	0.5	14.4	250.0	356B
ACZRC5357B-G	20.0	65	3.0	75	1	0.5	15.2	237.0	357B
ACZRC5358B-G	22.0	50	3.5	75	1	0.5	16.7	216.0	358B
ACZRC5359B-G	24.0	50	3.5	100	1	0.5	18.2	198.0	359B
ACZRC5360B-G	25.0	50	4.0	110	1	0.5	19.0	190.0	360B
ACZRC5361B-G	27.0	50	5.0	120	1	0.5	20.6	176.0	361B
ACZRC5362B-G	28.0	50	6.0	130	1	0.5	21.2	170.0	362B
ACZRC5363B-G	30.0	40	8.0	140	1	0.5	22.8	158.0	363B
ACZRC5364B-G	33.0	40	10.0	150	1	0.5	25.1	144.0	364B
ACZRC5365B-G	36.0	30	11.0	160	1	0.5	27.4	132.0	365B
ACZRC5366B-G	39.0	30	14.0	170	1	0.5	29.7	122.0	366B
ACZRC5367B-G	43.0	30	20.0	190	1	0.5	32.7	110.0	367B
ACZRC5368B-G	47.0	25	25.0	210	1	0.5	35.8	100.0	368B
ACZRC5369B-G	51.0	25	27.0	230	1	0.5	38.8	93.0	369B
ACZRC5370B-G	56.0	20	35.0	280	1	0.5	42.6	86.0	370B
ACZRC5371B-G	60.0	20	40.0	350	1	0.5	45.5	79.0	371B
ACZRC5372B-G	62.0	20	42.0	400	1	0.5	47.1	76.0	372B
ACZRC5373B-G	68.0	20	44.0	500	1	0.5	51.7	70.0	373B
ACZRC5374B-G	75.0	20	45.0	620	1	0.5	56.0	63.0	374B
ACZRC5375B-G	82.0	15	65.0	720	1	0.5	62.2	58.0	375B
ACZRC5376B-G	87.0	15	75.0	760	1	0.5	66.0	54.5	376B
ACZRC5377B-G	91.0	15	75.0	760	1	0.5	69.2	52.5	377B

Notes:

- (1) The type number listed have a standard tolerance on the nominal zener voltage of $\pm 5\%$.
- (2) The reverse surge current is a non-repetitive, 8.3ms pulse width square wave or equivalent sine-wave superimposed on IzT per JEDEC Method.

Company reserves the right to improve product design, functions and reliability without notice.

REV: D

Electrical Characteristics (at TA=25°C unless otherwise specified)

Part Number	Nominal Zener Voltage		Maximum Zener Impedance			Maximum Reverse Leakage Current		Maximum DC Zener Current	Marking Code
	Vz @ IZT	IZT	ZzT @ IZT	ZzK @ IZK	IZK	IR @ VR		IZM	
	(V)	(mA)	(Ohm)	(Ohm)	(mA)	(uA)	(V)	(mA)	
ACZRC5378B-G	100.0	12	90.0	800	1	0.5	76.0	47.5	378B
ACZRC5379B-G	110.0	12	125.0	1000	1	0.5	83.6	43.0	379B
ACZRC5380B-G	120.0	10	170.0	1150	1	0.5	91.2	39.5	380B
ACZRC5381B-G	130.0	10	190.0	1250	1	0.5	98.8	36.6	381B
ACZRC5382B-G	140.0	8	230.0	1500	1	0.5	106.0	34.0	382B
ACZRC5383B-G	150.0	8	330.0	1500	1	0.5	114.0	31.6	383B
ACZRC5384B-G	160.0	8	350.0	1650	1	0.5	122.0	29.4	384B
ACZRC5385B-G	170.0	8	380.0	1750	1	0.5	129.0	28.0	385B
ACZRC5386B-G	180.0	5	430.0	1750	1	0.5	137.0	26.4	386B
ACZRC5387B-G	190.0	5	450.0	1850	1	0.5	144.0	25.0	387B
ACZRC5388B-G	200.0	5	480.0	1850	1	0.5	152.0	23.6	388B

Notes:

- (1) The type number listed have a standard tolerance on th nominal zener voltage of $\pm 5\%$.
- (2) The reverse surge current is a non-repetitive,8.3ms pulse width square wave or equivalent sine-wave superimposed on IZT per JEDEC Method.

Reel Taping Specification

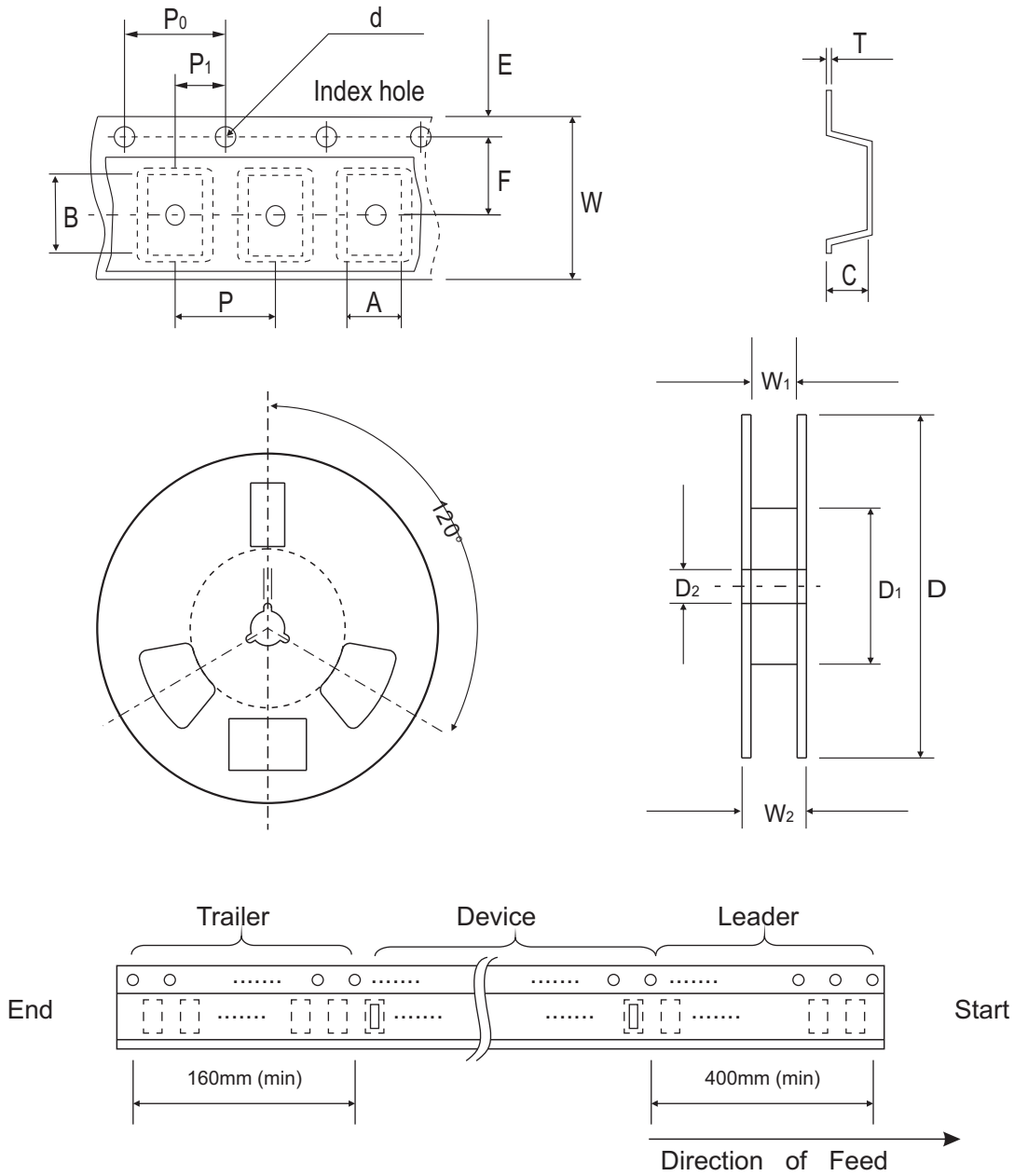

DO-214AB (SMC)	SYMBOL	A	B	C	d	T	D	D ₁	D ₂
	(mm)	See Note 1			1.55 ± 0.05	0.40 (Max.)	330.00	50.00 (Min.)	13.00 ^{+0.50} _{-0.20}
	(inch)	See Note 1			0.061 ± 0.002	0.016 (Max.)	13.000	1.969 (Min.)	0.512 ^{+0.020} _{-0.008}
DO-214AB (SMC)	SYMBOL	E	F	P	P ₀	P ₁	W	W ₁	W ₂
	(mm)	1.75 ± 0.10	7.50 ± 0.05	8.00 ± 0.10	4.00 ± 0.10	2.00 ± 0.05	16.00 ± 0.10	16.40 ^{+2.00} _{-0.00}	22.40 (Max.)
	(inch)	0.069 ± 0.004	0.295 ± 0.002	0.315 ± 0.004	0.157 ± 0.004	0.079 ± 0.002	0.630 ± 0.004	0.646 ^{+0.079} _{-0.000}	0.882 (Max.)

Notes: 1. A, B, and C the clearance between the component and the cavity must be within 0.5 mm max. for 8 mm tape and 12 mm tape, 1.0 mm max. for 16mm tape and 24 mm tape.

Company reserves the right to improve product design , functions and reliability without notice.

REV: D