

ACZRT55C-G Series

RoHS Device

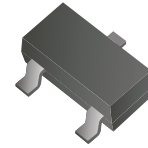

Features

- Planar Die Construction.
- Ideally Suited For Automated Assembly Processes.
- Comply with AEC-Q101

Mechanical data

- Case: Molded plastic, SOT-23
- Mounting position: Any

Circuit diagram

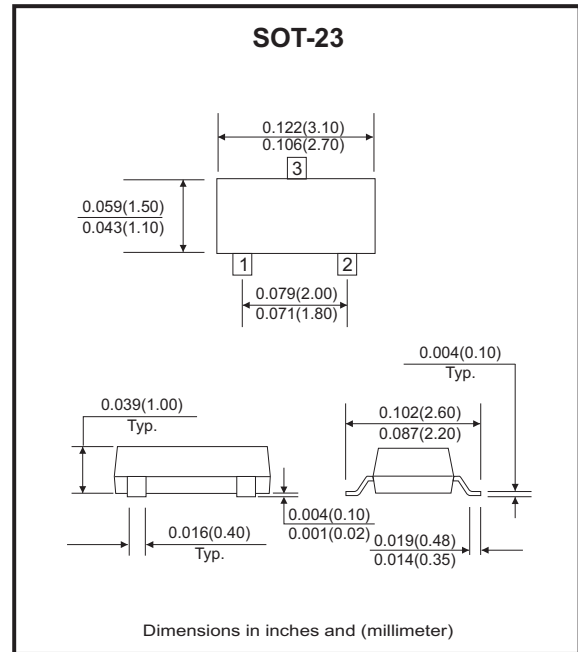
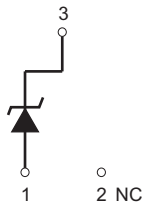

Maximum Ratings (T_A=25°C unless otherwise noted)

Parameter	Symbol	Value	Unit
Forward voltage at I _F =10mA	V _F	0.9	V
Power dissipation	P _D	350	mW
Thermal resistance, junction to ambient air	R _{θJA}	500	°C/W
Junction temperature range	T _J	-55 to +150	°C
Storage temperature range	T _{STG}	-65 to +150	°C

Note: 1. Valid provided that device terminals are kept at ambient temperature.
 2. Tested with pulses, 300µs pulse width, period = 5ms.
 3. f = 1KHz.

Electrical Characteristics (TA=25°C unless otherwise noted)

Part Number	Zener Voltage			Maximum Zener Impedance			Maximum Reverse Current		Typ. Temp. Coefficient		Marking Code	
	VZT			@ IZT	ZZT@ IZT	Zzk	@ IZK	IR @ VR		@ IZT mV/°C		
	Nom(V)	Min(V)	Max(V)	(mA)	(Ω)	(Ω)	(mA)	(μA)	(V)	Min.		Max.
ACZRT55C2V4-G	2.4	2.2	2.6	5.0	100	600	1.0	50	1.0	-3.5	0	Z11
ACZRT55C2V7-G	2.7	2.5	2.9	5.0	100	600	1.0	20	1.0	-3.5	0	Z12
ACZRT55C3V0-G	3.0	2.8	3.2	5.0	95	600	1.0	10	1.0	-3.5	0	Z13
ACZRT55C3V3-G	3.3	3.1	3.5	5.0	95	600	1.0	5.0	1.0	-3.5	0	Z14
ACZRT55C3V6-G	3.6	3.4	3.8	5.0	90	600	1.0	5.0	1.0	-3.5	0	Z15
ACZRT55C3V9-G	3.9	3.7	4.1	5.0	90	600	1.0	3.0	1.0	-3.5	0	Z16
ACZRT55C4V3-G	4.3	4.0	4.6	5.0	90	600	1.0	3.0	1.0	-3.5	0	Z17
ACZRT55C4V6-G	4.6	4.3	4.9	5.0	90	600	1.0	3.0	1.0	-3.5	0	Z18
ACZRT55C4V7-G	4.7	4.4	5.0	5.0	80	500	1.0	3.0	2.0	-3.5	0.2	Z1
ACZRT55C5V1-G	5.1	4.8	5.4	5.0	60	480	1.0	2.0	2.0	-2.7	1.2	Z2
ACZRT55C5V6-G	5.6	5.2	6.0	5.0	40	400	1.0	1.0	2.0	-2.0	2.5	Z3
ACZRT55C6V2-G	6.2	5.8	6.6	5.0	10	150	1.0	3.0	4.0	0.4	3.7	Z4
ACZRT55C6V8-G	6.8	6.4	7.2	5.0	15	80	1.0	2.0	4.0	1.2	4.5	Z5
ACZRT55C7V5-G	7.5	7.0	7.9	5.0	15	80	1.0	1.0	5.0	2.5	5.3	Z6
ACZRT55C8V2-G	8.2	7.7	8.7	5.0	15	80	1.0	0.7	5.0	3.2	6.2	Z7
ACZRT55C9V1-G	9.1	8.5	9.6	5.0	15	100	1.0	0.5	6.0	3.8	7.0	Z8
ACZRT55C10-G	10	9.4	10.6	5.0	20	150	1.0	0.2	7.0	4.5	8.0	Z9
ACZRT55C11-G	11	10.4	11.6	5.0	20	150	1.0	0.1	8.0	5.4	9.0	Y1
ACZRT55C12-G	12	11.4	12.7	5.0	25	150	1.0	0.1	8.0	6.0	10.0	Y2
ACZRT55C13-G	13	12.4	14.1	5.0	30	170	1.0	0.1	8.0	7.0	11.0	Y3
ACZRT55C15-G	15	13.8	15.6	5.0	30	200	1.0	0.1	10.5	9.2	13.0	Y4
ACZRT55C16-G	16	15.3	17.1	5.0	40	200	1.0	0.1	11.2	10.4	14.0	Y5
ACZRT55C18-G	18	16.8	19.1	5.0	45	225	1.0	0.1	12.6	12.4	16.0	Y6
ACZRT55C20-G	20	18.8	21.2	5.0	55	225	1.0	0.1	14.0	14.4	18.0	Y7
ACZRT55C22-G	22	20.8	23.3	5.0	55	250	1.0	0.1	15.4	16.4	20.0	Y8
ACZRT55C24-G	24	22.8	25.6	5.0	70	250	1.0	0.1	16.8	18.4	22.0	Y9
ACZRT55C27-G	27	25.1	28.9	2.0	80	300	0.5	0.1	18.9	21.4	25.3	Y10

Company reserves the right to improve product design , functions and reliability without notice.

REV: B

Electrical Characteristics (TA=25°C unless otherwise noted)

Part Number	Zener Voltage			Maximum Zener Impedance			Maximum Reverse Current		Typ. Temp. Coefficient		Marking Code	
	V _{ZT}			@ I _{ZT}	Z _{ZT} @ I _{ZT}	Z _{ZK}	@ I _{ZK}	I _R @ V _R		@ I _{ZT} mV/°C		
	Nom(V)	Min(V)	Max(V)	(mA)	(Ω)	(Ω)	(mA)	(μA)	(V)	Min.		Max.
ACZRT55C30-G	30	28.0	32.0	2.0	80	300	0.5	0.1	21.0	24.4	29.4	Y11
ACZRT55C33-G	33	31.0	35.0	2.0	80	325	0.5	0.1	23.1	27.4	33.4	Y12
ACZRT55C36-G	36	34.0	38.0	2.0	90	350	0.5	0.1	25.2	30.4	37.4	Y13
ACZRT55C39-G	39	37.0	41.0	2.0	130	350	0.5	0.1	27.3	33.4	41.2	Y14
ACZRT55C43-G	43	40.0	46.0	2.0	150	375	0.5	0.1	30.1	10.0	12.0	Y15
ACZRT55C47-G	47	44.0	50.0	2.0	170	375	0.5	0.1	32.9	10.0	12.0	Y16
ACZRT55C51-G	51	48.0	54.0	2.0	180	400	0.5	0.1	35.7	10.0	12.0	Y17
ACZRT55C56-G	56	52.0	60.0	2.0	200	425	0.5	0.05	39.2	10.0	12.0	Y18
ACZRT55C62-G	62	58.0	66.0	2.0	215	450	0.5	0.05	43.4	10.0	12.0	Y19
ACZRT55C68-G	68	64.0	72.0	2.0	240	475	0.5	0.05	47.6	10.0	12.0	Y20
ACZRT55C75-G	75	70.0	79.0	2.0	255	500	0.5	0.05	52.5	10.0	12.0	Y21

TYPICAL RATING AND CHARACTERISTIC CURVES (ACZRT55C-G Series)

Fig.1 - Power Derating Curve

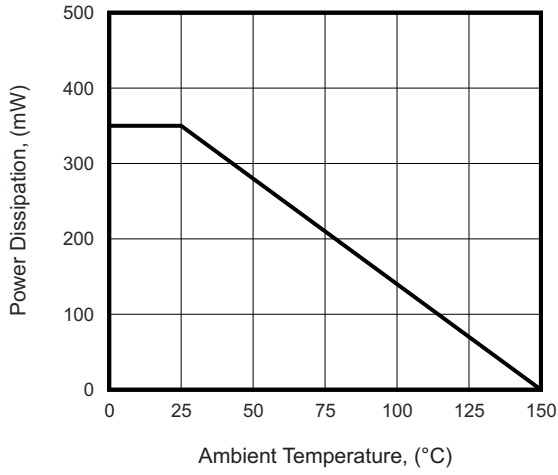

Fig.2 - Zener Breakdown Characteristics

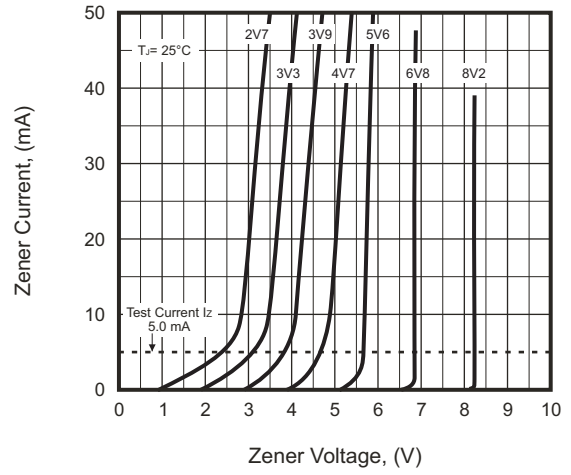

Fig.3 - Zener Breakdown Characteristics

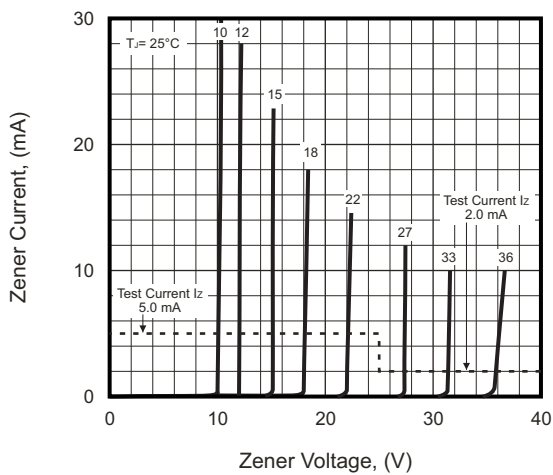
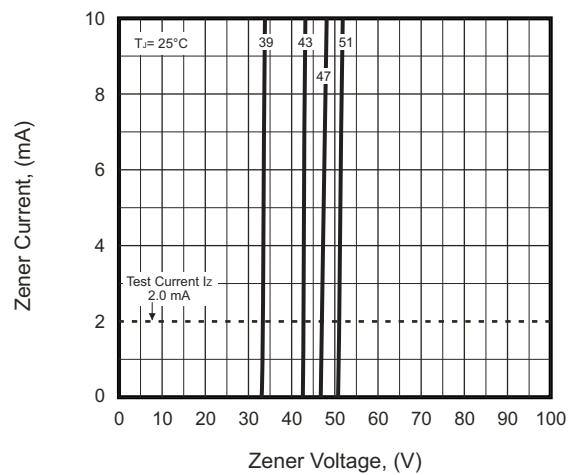
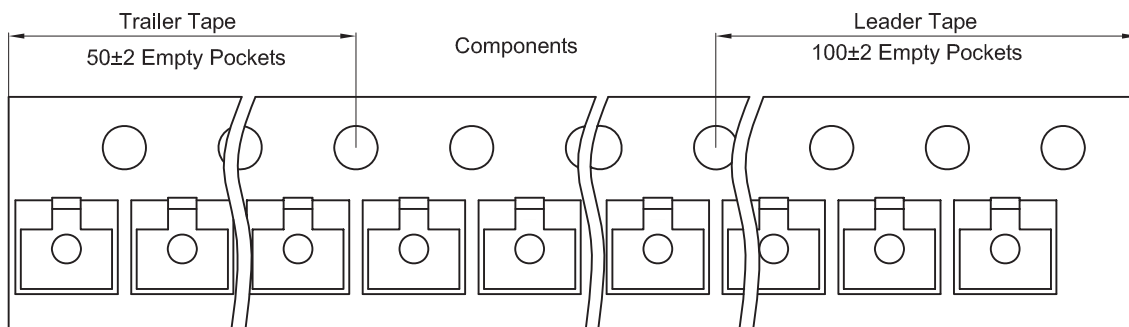
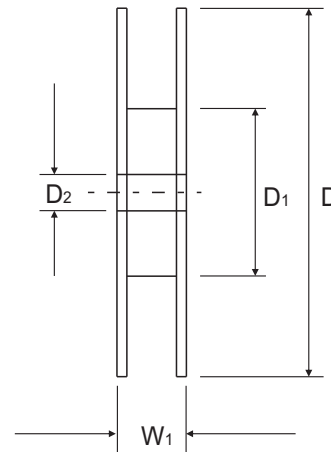
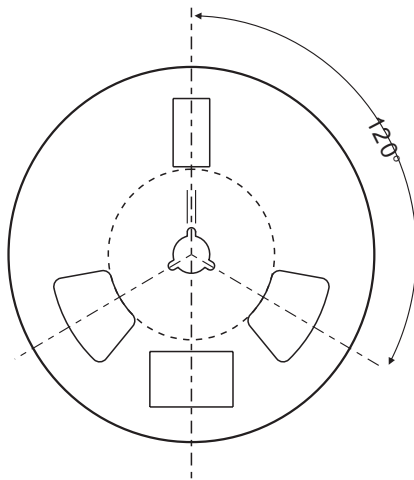
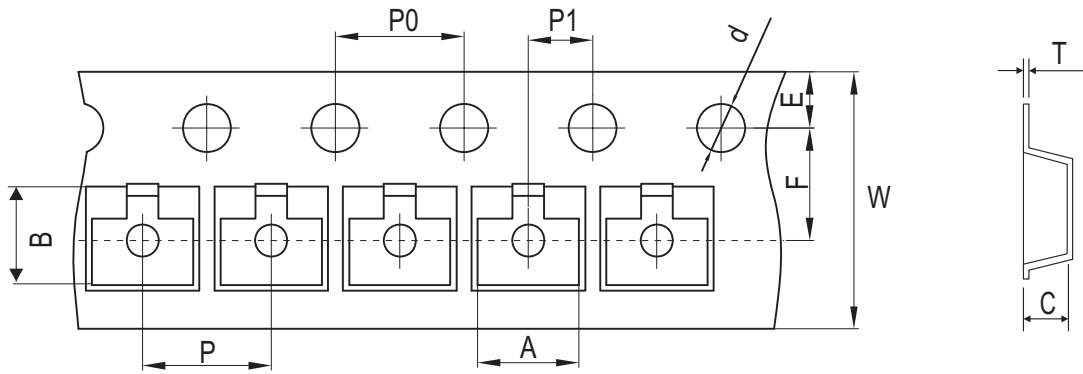

Fig.4 - Zener Breakdown Characteristics



Reel Taping Specification



SOT-23	SYMBOL	A	B	C	d	D	D1	D2
	(mm)	3.15 ± 0.10	2.77 ± 0.10	1.22 ± 0.10	1.50 + 0.10	178.00 ± 1.00	54.00 ± 0.50	13.00 ± 0.50
	(inch)	0.124 ± 0.004	0.109 ± 0.004	0.048 ± 0.004	0.059 + 0.004	7.008 ± 0.039	2.126 ± 0.020	0.512 ± 0.020

SOT-23	SYMBOL	E	F	P	P0	P1	W	W1
	(mm)	1.75 ± 0.10	3.50 ± 0.05	4.00 ± 0.10	4.00 ± 0.10	2.00 ± 0.05	8.00 + 0.30 / - 0.10	9.50 ± 1.00
	(inch)	0.069 ± 0.004	0.138 ± 0.002	0.158 ± 0.004	0.158 ± 0.004	0.079 ± 0.002	0.315 + 0.012 / - 0.004	0.374 ± 0.039

Company reserves the right to improve product design, functions and reliability without notice.

REV: B