

Dual Channel, 128-/256-Position, I<sup>2</sup>C, Nonvolatile Digital Potentiometer

FEATURES

- ▶ 10 kΩ and 100 kΩ resistance options
- ▶ Resistor tolerance: 8% maximum
- ▶ Wiper current: ±6 mA
- ▶ Low temperature coefficient: 35 ppm/°C
- ▶ Wide bandwidth: 3 MHz
- ▶ Fast start-up time < 75 μs
- ▶ Linear gain setting mode
- ▶ Single- and dual-supply operation
- ▶ Independent logic supply: 1.8 V to 5.5 V
- ▶ Wide operating temperature: -40°C to +125°C
- ▶ [3 mm × 3 mm package option](#)
- ▶ Qualified for automotive applications

APPLICATIONS

- ▶ Portable electronics level adjustment
- ▶ LCD panel brightness and contrast controls
- ▶ Programmable filters, delays, and time constants
- ▶ Programmable power supplies

GENERAL DESCRIPTION

The AD5122A/AD5142A potentiometers provide a nonvolatile solution for 128-/256-position adjustment applications, offering guaranteed low resistor tolerance errors of ±8% and up to ±6 mA current density in the Ax, Bx, and Wx pins.

The low resistor tolerance and low nominal temperature coefficient simplify open-loop applications as well as applications requiring tolerance matching.

The linear gain setting mode allows independent programming of the resistance between the digital potentiometer terminals, through R<sub>AW</sub> and R<sub>WB</sub> the string resistors, allowing very accurate resistor matching.

The high bandwidth and low total harmonic distortion (THD) ensure optimal performance for ac signals, making it suitable for filter design.

The low wiper resistance of only 40 Ω at the ends of the resistor array allows for pin-to-pin connection.

The wiper values can be set through an I<sup>2</sup>C-compatible digital interface that is also used to read back the wiper register and EEPROM contents.

The AD5122A/AD5142A are available in a compact, [16-lead, 3 mm × 3 mm LFCSP](#) and a [16-lead TSSOP](#). The parts are guaranteed to

FUNCTIONAL BLOCK DIAGRAM

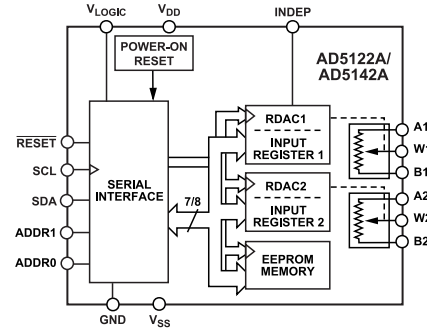

Figure 1.

operate over the extended industrial temperature range of -40°C to +125°C.

Table 1. Family Models

| Model                              | Channel | Position | Interface            | Package     |
|------------------------------------|---------|----------|----------------------|-------------|
| <a href="#">AD5123<sup>1</sup></a> | Quad    | 128      | I <sup>2</sup> C     | LFCSP       |
| <a href="#">AD5124</a>             | Quad    | 128      | SPI/I <sup>2</sup> C | LFCSP       |
| <a href="#">AD5124</a>             | Quad    | 128      | SPI                  | TSSOP       |
| <a href="#">AD5143<sup>1</sup></a> | Quad    | 256      | I <sup>2</sup> C     | LFCSP       |
| <a href="#">AD5144</a>             | Quad    | 256      | SPI/I <sup>2</sup> C | LFCSP       |
| <a href="#">AD5144</a>             | Quad    | 256      | SPI                  | TSSOP       |
| <a href="#">AD5144A</a>            | Quad    | 256      | I <sup>2</sup> C     | TSSOP       |
| <a href="#">AD5122</a>             | Dual    | 128      | SPI                  | LFCSP/TSSOP |
| <a href="#">AD5122A</a>            | Dual    | 128      | I <sup>2</sup> C     | LFCSP/TSSOP |
| <a href="#">AD5142</a>             | Dual    | 256      | SPI                  | LFCSP/TSSOP |
| <a href="#">AD5142A</a>            | Dual    | 256      | I <sup>2</sup> C     | LFCSP/TSSOP |
| <a href="#">AD5121</a>             | Single  | 128      | SPI/I <sup>2</sup> C | LFCSP       |
| <a href="#">AD5141</a>             | Single  | 256      | SPI/I <sup>2</sup> C | LFCSP       |

<sup>1</sup> Two potentiometers and two rheostats.

## TABLE OF CONTENTS

|   |    |  |    |
|---|----|--|----|
| Features.....                                     | 1  | RDAC Register and EEPROM.....  | 18 |
| Applications.....                                 | 1  | Input Shift Register.....  | 18 |
| Functional Block Diagram.....                     | 1  | I <sup>2</sup> C Serial Data Interface.....                            | 19 |
| General Description.....                          | 1  | Advanced Control Modes.....  | 22 |
| Specifications.....                               | 3  | EEPROM or RDAC Register Protection.....                                | 25 |
| Electrical Characteristics—AD5122A.....           | 3  | INDEP Pin.....   | 25 |
| Electrical Characteristics—AD5142A.....           | 5  | RDAC Architecture.....   | 25 |
| Interface Timing Specifications.....              | 8  | Programming the Variable Resistor.....                                 | 26 |
| Shift Register and Timing Diagrams.....           | 9  | Programming the Potentiometer Divider.....                             | 26 |
| Absolute Maximum Ratings.....                     | 10 | Terminal Voltage Operating Range.....                                  | 27 |
| Thermal Resistance.....                           | 10 | Power-Up Sequence.....   | 27 |
| Electrostatic Discharge (ESD) Ratings.....        | 10 | Layout and Power Supply Biasing.....                                   | 27 |
| ESD Ratings for AD5122A/AD5142A.....              | 10 | Outline Dimensions.....  | 28 |
| ESD Caution.....                                  | 10 | Ordering Guide.....  | 29 |
| Pin Configurations and Function Descriptions..... | 11 | R <sub>AB</sub> (K $\Omega$ ), Resolution, and Interface Options... .. | 29 |
| Typical Performance Characteristics.....          | 12 | Evaluation Boards.....   | 29 |
| Test Circuits.....                                | 17 | Automotive Products .....  | 30 |
| Theory of Operation.....                          | 18 |  |    |

## REVISION HISTORY

### 5/2022—Rev. B to Rev. C

|   |    |
|---|----|
| Changes to Nominal Resistance Match Parameter, Single-Supply Power Range Parameter, Dual-Supply Power Range Parameter, and Logic Supply Range Parameter, Table 2..... | 3  |
| Changes to Nominal Resistance Match Parameter, Single-Supply Power Range Parameter, Dual-Supply Power Range Parameter, and Logic Supply Range Parameter, Table 3..... | 5  |
| Deleted FICDM Parameter, Table 5.....   | 10 |
| Added Electrostatic Discharge (ESD) Ratings Section.....  | 10 |
| Added ESD Ratings for AD5122A/AD5142A Section, Table 7, and Table 8; Renumbered Sequentially.....   | 10 |
| Deleted Table 8, Renumbered Sequentially.....   | 11 |
| Moved Table 10 and Table 11.....  | 18 |
| Added Write Operation Section, Figure 38, and Figure 39; Renumbered Sequentially.....   | 19 |
| Added EEPROM Write Acknowledge Polling Section.....   | 21 |
| Added Read Operation Section and Figure 40.....   | 21 |
| Moved Table 13, Table 14, and Table 15.....   | 22 |
| Changes to Table 13.....  | 22 |
| Changes to Ordering Guide.....  | 29 |
| Added R <sub>AB</sub> (K $\Omega$ ), Resolution, and Interface Options Section.....   | 29 |

## SPECIFICATIONS

## ELECTRICAL CHARACTERISTICS—AD5122A

$V_{DD} = 2.3 \text{ V to } 5.5 \text{ V}$ ,  $V_{SS} = 0 \text{ V}$ ;  $V_{DD} = 2.25 \text{ V to } 2.75 \text{ V}$ ,  $V_{SS} = -2.25 \text{ V to } -2.75 \text{ V}$ ;  $V_{LOGIC} = 1.8 \text{ V to } 5.5 \text{ V}$ ,  $-40^\circ\text{C} < T_A < +125^\circ\text{C}$ , unless otherwise noted.

Table 2.

| Parameter   | Symbol  | Test Conditions/Comments                                     | Min      | Typ <sup>1</sup> | Max      | Unit     |
|---|---|--|----------|------------------|----------|----------|
| DC CHARACTERISTICS—RHEOSTAT MODE (ALL RDACs)              |   |  |          |                  |          |          |
| Resolution  | N   |  | 7        |                  |          | Bits     |
| Resistor Integral Nonlinearity <sup>2</sup>               | R-INL   | $R_{AB} = 10 \text{ k}\Omega$<br>$V_{DD} \geq 2.7 \text{ V}$ | -1       | $\pm 0.1$        | +1       | LSB      |
|   |   | $V_{DD} < 2.7 \text{ V}$<br>$R_{AB} = 100 \text{ k}\Omega$   | -2.5     | $\pm 1$          | +2.5     | LSB      |
| Resistor Differential Nonlinearity <sup>2</sup>           | R-DNL   | $V_{DD} \geq 2.7 \text{ V}$                                  | -0.5     | $\pm 0.1$        | +0.5     | LSB      |
|   |   | $V_{DD} < 2.7 \text{ V}$                                     | -1       | $\pm 0.25$       | +1       | LSB      |
| Nominal Resistor Tolerance                                | $\Delta R_{AB}/R_{AB}$                        |  | -8       | $\pm 1$          | +8       | %        |
| Resistance Temperature Coefficient <sup>3</sup>           | $(\Delta R_{AB}/R_{AB})/\Delta T \times 10^6$ | Code = full scale  |          | 35               |          | ppm/°C   |
| Wiper Resistance <sup>3</sup>                             | $R_W$   | Code = zero scale  |          |                  |          |          |
|   |   | $R_{AB} = 10 \text{ k}\Omega$                                |          | 55               | 125      | $\Omega$ |
|   |   | $R_{AB} = 100 \text{ k}\Omega$                               |          | 130              | 400      | $\Omega$ |
| Bottom Scale or Top Scale                                 | $R_{BS}$ or $R_{TS}$                          | $R_{AB} = 10 \text{ k}\Omega$                                |          | 40               | 80       | $\Omega$ |
|   |   | $R_{AB} = 100 \text{ k}\Omega$                               |          | 60               | 230      | $\Omega$ |
|   |   | Code = full scale  | -1       | $\pm 0.2$        | +1       | %        |
| DC CHARACTERISTICS—POTENTIOMETER DIVIDER MODE (ALL RDACs) |   |  |          |                  |          |          |
| Integral Nonlinearity <sup>4</sup>                        | INL   | $R_{AB} = 10 \text{ k}\Omega$                                | -0.5     | $\pm 0.1$        | +0.5     | LSB      |
|   |   | $R_{AB} = 100 \text{ k}\Omega$                               | -0.25    | $\pm 0.1$        | +0.25    | LSB      |
| Differential Nonlinearity <sup>4</sup>                    | DNL   |  | -0.25    | $\pm 0.1$        | +0.25    | LSB      |
| Full-Scale Error  | $V_{WFSE}$                                    | $R_{AB} = 10 \text{ k}\Omega$                                | -1.5     | -0.1             |          | LSB      |
|   |   | $R_{AB} = 100 \text{ k}\Omega$                               | -0.5     | $\pm 0.1$        | +0.5     | LSB      |
| Zero-Scale Error  | $V_{WZSE}$                                    | $R_{AB} = 10 \text{ k}\Omega$                                |          | 1                | 1.5      | LSB      |
|   |   | $R_{AB} = 100 \text{ k}\Omega$                               |          | 0.25             | 0.5      | LSB      |
| Voltage Divider Temperature Coefficient <sup>3</sup>      | $(\Delta V_W/V_W)/\Delta T \times 10^6$       | Code = half scale  |          | $\pm 5$          |          | ppm/°C   |
| RESISTOR TERMINALS  |   |  |          |                  |          |          |
| Maximum Continuous Current                                | $I_A$ , $I_B$ , and $I_W$                     | $R_{AB} = 10 \text{ k}\Omega$                                | -6       |                  | +6       | mA       |
|   |   | $R_{AB} = 100 \text{ k}\Omega$                               | -1.5     |                  | +1.5     | mA       |
| Terminal Voltage Range <sup>5</sup>                       |   |  | $V_{SS}$ |                  | $V_{DD}$ | V        |
| Capacitance A, Capacitance B <sup>3</sup>                 | $C_A$ , $C_B$                                 | $f = 1 \text{ MHz}$ , measured to GND, code = half scale     |          |                  |          |          |
|   |   | $R_{AB} = 10 \text{ k}\Omega$                                |          | 25               |          | pF       |
|   |   | $R_{AB} = 100 \text{ k}\Omega$                               |          | 12               |          | pF       |
| Capacitance W <sup>3</sup>                                | $C_W$   | $f = 1 \text{ MHz}$ , measured to GND, code = half scale     |          |                  |          |          |
|   |   | $R_{AB} = 10 \text{ k}\Omega$                                |          | 12               |          | pF       |

## SPECIFICATIONS

Table 2.

| Parameter                                | Symbol                  | Test Conditions/Comments  | Min  | Typ <sup>1</sup> | Max                    | Unit   |
|--|-------------------------|---|--|------------------|------------------------|--|
| Common-Mode Leakage Current <sup>3</sup> |                         | $R_{AB} = 100\text{ k}\Omega$<br>$V_A = V_W = V_B$  | -500   | 5<br>$\pm 15$    | +500                   | pF<br>nA   |
| DIGITAL INPUTS                           |                         |   |  |                  |                        |  |
| Input Logic <sup>3</sup>                 |                         |   |  |                  |                        |  |
| High                                     | $V_{INH}$               | $V_{LOGIC} = 1.8\text{ V to }2.3\text{ V}$<br>$V_{LOGIC} = 2.3\text{ V to }5.5\text{ V}$  | $0.8 \times V_{LOGIC}$<br>$0.7 \times V_{LOGIC}$ |                  |                        | V<br>V   |
| Low                                      | $V_{INL}$               |   |  |                  | $0.2 \times V_{LOGIC}$ | V  |
| Input Hysteresis <sup>3</sup>            | $V_{HYST}$              |   | $0.1 \times V_{LOGIC}$                           |                  |                        | V  |
| Input Current <sup>3</sup>               | $I_{IN}$                |   |  |                  | $\pm 1$                | $\mu\text{A}$                                    |
| Input Capacitance <sup>3</sup>           | $C_{IN}$                |   |  | 5                |                        | pF   |
| DIGITAL OUTPUTS                          |                         |   |  |                  |                        |  |
| Output High Voltage <sup>3</sup>         | $V_{OH}$                | $R_{PULL-UP} = 2.2\text{ k}\Omega\text{ to }V_{LOGIC}$  |  | $V_{LOGIC}$      |                        | V  |
| Output Low Voltage <sup>3</sup>          | $V_{OL}$                | $I_{SINK} = 3\text{ mA}$<br>$I_{SINK} = 6\text{ mA}, V_{LOGIC} > 2.3\text{ V}$  |  |                  | 0.4<br>0.6             | V<br>V   |
| Three-State Leakage Current              |                         |   | -1   |                  | +1                     | $\mu\text{A}$                                    |
| Three-State Output Capacitance           |                         |   |  | 2                |                        | pF   |
| POWER SUPPLIES                           |                         |   |  |                  |                        |  |
| Single-Supply Power Range                | $V_{DD}$                | $V_{SS} = \text{GND}$   | 2.3  |                  | 5.5                    | V  |
| Dual-Supply Power Range                  | $V_{DD}/V_{SS}$         |   | $\pm 2.25$                                       |                  | $\pm 2.75$             | V  |
| Logic Supply Range                       | $V_{LOGIC}$             | Single supply, $V_{SS} = \text{GND}$<br>Dual supply, $V_{SS} < \text{GND}$  | 1.8<br>2.25                                      |                  | $V_{DD}$<br>$V_{DD}$   | V<br>V   |
| Positive Supply Current                  | $I_{DD}$                | $V_{IH} = V_{LOGIC}\text{ or }V_{IL} = \text{GND}$<br>$V_{DD} = 5.5\text{ V}$<br>$V_{DD} = 2.3\text{ V}$  |  | 0.7<br>400       | 5.5                    | $\mu\text{A}$<br>nA                              |
| Negative Supply Current                  | $I_{SS}$                | $V_{IH} = V_{LOGIC}\text{ or }V_{IL} = \text{GND}$  | -5.5   | -0.7             |                        | $\mu\text{A}$                                    |
| EEPROM Store Current <sup>3, 6</sup>     | $I_{DD\_EEPROM\_STORE}$ | $V_{IH} = V_{LOGIC}\text{ or }V_{IL} = \text{GND}$  |  | 2                |                        | mA   |
| EEPROM Read Current <sup>3, 7</sup>      | $I_{DD\_EEPROM\_READ}$  | $V_{IH} = V_{LOGIC}\text{ or }V_{IL} = \text{GND}$  |  | 320              |                        | $\mu\text{A}$                                    |
| Logic Supply Current                     | $I_{LOGIC}$             | $V_{IH} = V_{LOGIC}\text{ or }V_{IL} = \text{GND}$  |  | 0.05             | 1.4                    | $\mu\text{A}$                                    |
| Power Dissipation <sup>8</sup>           | $P_{DISS}$              | $V_{IH} = V_{LOGIC}\text{ or }V_{IL} = \text{GND}$  |  | 3.5              |                        | $\mu\text{W}$                                    |
| Power Supply Rejection Ratio             | PSRR                    | $\Delta V_{DD}/\Delta V_{SS} = V_{DD} \pm 10\%$ , code = full scale   |  | -66              | -60                    | dB   |
| DYNAMIC CHARACTERISTICS <sup>9</sup>     |                         |   |  |                  |                        |  |
| Bandwidth                                | BW                      | -3 dB<br>$R_{AB} = 10\text{ k}\Omega$<br>$R_{AB} = 100\text{ k}\Omega$  |  | 3<br>0.43        |                        | MHz<br>MHz                                       |
| Total Harmonic Distortion                | THD                     | $V_{DD}/V_{SS} = \pm 2.5\text{ V}$ , $V_A = 1\text{ V rms}$ , $V_B = 0\text{ V}$ , $f = 1\text{ kHz}$<br>$R_{AB} = 10\text{ k}\Omega$<br>$R_{AB} = 100\text{ k}\Omega$    |  | -80<br>-90       |                        | dB<br>dB   |
| Resistor Noise Density                   | $e_{N\_WB}$             | Code = half scale, $T_A = 25^\circ\text{C}$ , $f = 10\text{ kHz}$<br>$R_{AB} = 10\text{ k}\Omega$<br>$R_{AB} = 100\text{ k}\Omega$  |  | 7<br>20          |                        | nV/ $\sqrt{\text{Hz}}$<br>nV/ $\sqrt{\text{Hz}}$ |
| $V_W$ Settling Time                      | $t_S$                   | $V_A = 5\text{ V}$ , $V_B = 0\text{ V}$ , from zero scale to full scale, $\pm 0.5\text{ LSB}$ error band<br>$R_{AB} = 10\text{ k}\Omega$<br>$R_{AB} = 100\text{ k}\Omega$ |  | 2<br>12          |                        | $\mu\text{s}$<br>$\mu\text{s}$                   |
| Crosstalk ( $C_{W1}/C_{W2}$ )            | $C_T$                   | $R_{AB} = 10\text{ k}\Omega$<br>$R_{AB} = 100\text{ k}\Omega$   |  | 10<br>25         |                        | nV-sec<br>nV-sec                                 |

## SPECIFICATIONS

Table 2.

| Parameter                                   | Symbol   | Test Conditions/Comments | Min | Typ <sup>1</sup> | Max | Unit             |
|---|----------|--------------------------|-----|------------------|-----|------------------|
| Analog Crosstalk<br>Endurance <sup>10</sup> | $C_{TA}$ | $T_A = 25^\circ\text{C}$ |     | -90<br>1         |     | dB<br>Mcycles    |
| Data Retention <sup>11, 12</sup>            |          |                          | 100 | 50               |     | kcycles<br>Years |

<sup>1</sup> Typical values represent average readings at  $25^\circ\text{C}$ ,  $V_{DD} = 5\text{ V}$ ,  $V_{SS} = 0\text{ V}$ , and  $V_{LOGIC} = 5\text{ V}$ .

<sup>2</sup> Resistor integral nonlinearity (R-INL) error is the deviation from an ideal value measured between the maximum resistance and the minimum resistance wiper positions. R-DNL measures the relative step change from ideal between successive tap positions. The maximum wiper current is limited to  $(0.7 \times V_{DD})/R_{AB}$ .

<sup>3</sup> Guaranteed by design and characterization, not subject to production test.

<sup>4</sup> INL and DNL are measured at  $V_{WB}$  with the RDAC configured as a potentiometer divider similar to a voltage output DAC.  $V_A = V_{DD}$  and  $V_B = 0\text{ V}$ . DNL specification limits of  $\pm 1\text{ LSB}$  maximum are guaranteed monotonic operating conditions.

<sup>5</sup> Resistor Terminal A, Resistor Terminal B, and Resistor Terminal W have no limitations on polarity with respect to each other. Dual-supply operation enables ground referenced bipolar signal adjustment.

<sup>6</sup> Different from operating current; supply current for EEPROM program lasts approximately 30 ms.

<sup>7</sup> Different from operating current; supply current for EEPROM read lasts approximately 20  $\mu\text{s}$ .

<sup>8</sup>  $P_{DISS}$  is calculated from  $(I_{DD} \times V_{DD}) + (I_{LOGIC} \times V_{LOGIC})$ .

<sup>9</sup> All dynamic characteristics use  $V_{DD}/V_{SS} = \pm 2.5\text{ V}$ , and  $V_{LOGIC} = 2.5\text{ V}$ .

<sup>10</sup> Endurance is qualified to 100,000 cycles per JEDEC Standard 22, Method A117 and measured at  $-40^\circ\text{C}$  to  $+125^\circ\text{C}$ .

<sup>11</sup> Retention lifetime equivalent at junction temperature ( $T_J$ ) =  $125^\circ\text{C}$  per JEDEC Standard 22, Method A117. Retention lifetime, based on an activation energy of 1 eV, derates with junction temperature in the Flash/EE memory.

<sup>12</sup> 50 years apply to an endurance of 1000 cycles. An endurance of 100,000 cycles has an equivalent retention lifetime of 5 years.

## ELECTRICAL CHARACTERISTICS—AD5142A

$V_{DD} = 2.3\text{ V}$  to  $5.5\text{ V}$ ,  $V_{SS} = 0\text{ V}$ ;  $V_{DD} = 2.25\text{ V}$  to  $2.75\text{ V}$ ,  $V_{SS} = -2.25\text{ V}$  to  $-2.75\text{ V}$ ;  $V_{LOGIC} = 1.8\text{ V}$  to  $5.5\text{ V}$ ,  $-40^\circ\text{C} < T_A < +125^\circ\text{C}$ , unless otherwise noted.

Table 3.

| Parameter                                       | Symbol  | Test Conditions/Comments      | Min | Typ <sup>1</sup> | Max | Unit                  |
|---|---|-------------------------------|-----|------------------|-----|-----------------------|
| DC CHARACTERISTICS—RHEOSTAT MODE (ALL RDACS)    |   |                               |     |                  |     |                       |
| Resolution                                      | N   |                               | 8   |                  |     | Bits                  |
| Resistor Integral Nonlinearity <sup>2</sup>     | R-INL   | $R_{AB} = 10\text{ k}\Omega$  |     |                  |     |                       |
|   |   | $V_{DD} \geq 2.7\text{ V}$    | -2  | $\pm 0.2$        | +2  | LSB                   |
|   |   | $V_{DD} < 2.7\text{ V}$       | -5  | $\pm 1.5$        | +5  | LSB                   |
|   |   | $R_{AB} = 100\text{ k}\Omega$ |     |                  |     |                       |
| Resistor Differential Nonlinearity <sup>2</sup> | R-DNL   | $V_{DD} \geq 2.7\text{ V}$    | -1  | $\pm 0.1$        | +1  | LSB                   |
|   |   | $V_{DD} < 2.7\text{ V}$       | -2  | $\pm 0.5$        | +2  | LSB                   |
| Nominal Resistor Tolerance                      | $\Delta R_{AB}/R_{AB}$                        |                               | -8  | $\pm 1$          | +8  | %                     |
| Resistance Temperature Coefficient <sup>3</sup> | $(\Delta R_{AB}/R_{AB})/\Delta T \times 10^6$ | Code = full scale             |     | 35               |     | ppm/ $^\circ\text{C}$ |
| Wiper Resistance <sup>3</sup>                   | $R_W$   | Code = zero scale             |     |                  |     |                       |
|   |   | $R_{AB} = 10\text{ k}\Omega$  |     | 55               | 125 | $\Omega$              |
|   |   | $R_{AB} = 100\text{ k}\Omega$ |     | 130              | 400 | $\Omega$              |
| Bottom Scale or Top Scale                       | $R_{BS}$ or $R_{TS}$                          | $R_{AB} = 10\text{ k}\Omega$  |     | 40               | 80  | $\Omega$              |
|   |   | $R_{AB} = 100\text{ k}\Omega$ |     | 60               | 230 | $\Omega$              |
| Nominal Resistance Match                        | $R_{AB1}/R_{AB2}$                             | Code = full scale             | -1  | $\pm 0.2$        | +1  | %                     |

## SPECIFICATIONS

Table 3.

| Parameter   | Symbol                                  | Test Conditions/Comments   | Min  | Typ <sup>1</sup>       | Max                    | Unit                |
|---|---|--|--|------------------------|------------------------|---------------------|
| DC CHARACTERISTICS—POTENTIOMETER DIVIDER MODE (ALL RDACs) |   |  |  |                        |                        |                     |
| Integral Nonlinearity <sup>4</sup>                        | INL                                     | $R_{AB} = 10\text{ k}\Omega$<br>$R_{AB} = 100\text{ k}\Omega$  | -1<br>-0.5                                       | $\pm 0.2$<br>$\pm 0.1$ | +1<br>+0.5             | LSB<br>LSB          |
| Differential Nonlinearity <sup>4</sup>                    | DNL                                     |  | -0.5   | $\pm 0.2$              | +0.5                   | LSB                 |
| Full-Scale Error  | $V_{WFSE}$                              | $R_{AB} = 10\text{ k}\Omega$<br>$R_{AB} = 100\text{ k}\Omega$  | -2.5<br>-1                                       | -0.1<br>$\pm 0.2$      |                        | LSB<br>LSB          |
| Zero-Scale Error  | $V_{WZSE}$                              | $R_{AB} = 10\text{ k}\Omega$<br>$R_{AB} = 100\text{ k}\Omega$  |  | 1.2<br>0.5             | 3<br>1                 | LSB<br>LSB          |
| Voltage Divider Temperature Coefficient <sup>3</sup>      | $(\Delta V_W/V_W)/\Delta T \times 10^6$ | Code = half scale  |  | $\pm 5$                |                        | ppm/°C              |
| RESISTOR TERMINALS  |   |  |  |                        |                        |                     |
| Maximum Continuous Current                                | $I_A$ , $I_B$ , and $I_W$               | $R_{AB} = 10\text{ k}\Omega$<br>$R_{AB} = 100\text{ k}\Omega$  | -6<br>-1.5                                       |                        | +6<br>+1.5             | mA<br>mA            |
| Terminal Voltage Range <sup>5</sup>                       |   |  | $V_{SS}$   |                        | $V_{DD}$               | V                   |
| Capacitance A, Capacitance B <sup>3</sup>                 | $C_A$ , $C_B$                           | $f = 1\text{ MHz}$ , measured to GND, code = half scale<br>$R_{AB} = 10\text{ k}\Omega$<br>$R_{AB} = 100\text{ k}\Omega$ |  | 25<br>12               |                        | pF<br>pF            |
| Capacitance W <sup>3</sup>                                | $C_W$                                   | $f = 1\text{ MHz}$ , measured to GND, code = half scale<br>$R_{AB} = 10\text{ k}\Omega$<br>$R_{AB} = 100\text{ k}\Omega$ |  | 12<br>5                |                        | pF<br>pF            |
| Common-Mode Leakage Current <sup>3</sup>                  |   | $V_A = V_W = V_B$  | -500   | $\pm 15$               | +500                   | nA                  |
| DIGITAL INPUTS  |   |  |  |                        |                        |                     |
| Input Logic <sup>3</sup>                                  |   |  |  |                        |                        |                     |
| High  | $V_{INH}$                               | $V_{LOGIC} = 1.8\text{ V to } 2.3\text{ V}$<br>$V_{LOGIC} = 2.3\text{ V to } 5.5\text{ V}$                               | $0.8 \times V_{LOGIC}$<br>$0.7 \times V_{LOGIC}$ |                        |                        | V<br>V              |
| Low   | $V_{INL}$                               |  |  |                        | $0.2 \times V_{LOGIC}$ | V                   |
| Input Hysteresis <sup>3</sup>                             | $V_{HYST}$                              |  | $0.1 \times V_{LOGIC}$                           |                        |                        | V                   |
| Input Current <sup>3</sup>                                | $I_{IN}$                                |  |  |                        | $\pm 1$                | $\mu\text{A}$       |
| Input Capacitance <sup>3</sup>                            | $C_{IN}$                                |  |  | 5                      |                        | pF                  |
| DIGITAL OUTPUTS   |   |  |  |                        |                        |                     |
| Output High Voltage <sup>3</sup>                          | $V_{OH}$                                | $R_{PULL-UP} = 2.2\text{ k}\Omega$ to $V_{LOGIC}$  |  | $V_{LOGIC}$            |                        | V                   |
| Output Low Voltage <sup>3</sup>                           | $V_{OL}$                                | $I_{SINK} = 3\text{ mA}$<br>$I_{SINK} = 6\text{ mA}$ , $V_{LOGIC} > 2.3\text{ V}$  |  |                        | 0.4<br>0.6             | V<br>V              |
| Three-State Leakage Current                               |   |  | -1   |                        | +1                     | $\mu\text{A}$       |
| Three-State Output Capacitance                            |   |  |  | 2                      |                        | pF                  |
| POWER SUPPLIES  |   |  |  |                        |                        |                     |
| Single-Supply Power Range                                 | $V_{DD}$                                | $V_{SS} = \text{GND}$  | 2.3  |                        | 5.5                    | V                   |
| Dual-Supply Power Range                                   | $V_{DD}/V_{SS}$                         |  | $\pm 2.25$                                       |                        | $\pm 2.75$             | V                   |
| Logic Supply Range  | $V_{LOGIC}$                             | Single supply, $V_{SS} = \text{GND}$<br>Dual supply, $V_{SS} < \text{GND}$   | 1.8<br>2.25                                      |                        | $V_{DD}$<br>$V_{DD}$   | V<br>V              |
| Positive Supply Current                                   | $I_{DD}$                                | $V_{IH} = V_{LOGIC}$ or $V_{IL} = \text{GND}$<br>$V_{DD} = 5.5\text{ V}$<br>$V_{DD} = 2.3\text{ V}$                      |  | 0.7<br>400             | 5.5                    | $\mu\text{A}$<br>nA |

## SPECIFICATIONS

Table 3.

| Parameter                                     | Symbol                       | Test Conditions/Comments   | Min  | Typ <sup>1</sup> | Max | Unit             |
|---|------------------------------|--|------|------------------|-----|------------------|
| Negative Supply Current                       | I <sub>SS</sub>              | V <sub>IH</sub> = V <sub>LOGIC</sub> or V <sub>IL</sub> = GND  | -5.5 | -0.7             |     | μA               |
| EEPROM Store Current <sup>3, 6</sup>          | I <sub>DD_EEPROM_STORE</sub> | V <sub>IH</sub> = V <sub>LOGIC</sub> or V <sub>IL</sub> = GND  |      | 2                |     | mA               |
| EEPROM Read Current <sup>3, 7</sup>           | I <sub>DD_EEPROM_READ</sub>  | V <sub>IH</sub> = V <sub>LOGIC</sub> or V <sub>IL</sub> = GND  |      | 320              |     | μA               |
| Logic Supply Current                          | I <sub>LOGIC</sub>           | V <sub>IH</sub> = V <sub>LOGIC</sub> or V <sub>IL</sub> = GND  |      | 0.05             | 1.4 | μA               |
| Power Dissipation <sup>8</sup>                | P <sub>DISS</sub>            | V <sub>IH</sub> = V <sub>LOGIC</sub> or V <sub>IL</sub> = GND  |      | 3.5              |     | μW               |
| Power Supply Rejection Ratio                  | PSRR                         | ΔV <sub>DD</sub> /ΔV <sub>SS</sub> = V <sub>DD</sub> ± 10%, code = full scale                        |      | -66              | -60 | dB               |
| <b>DYNAMIC CHARACTERISTICS<sup>9</sup></b>    |                              |  |      |                  |     |                  |
| Bandwidth                                     | BW                           | -3 dB  |      |                  |     |                  |
|   |                              | R <sub>AB</sub> = 10 kΩ  |      | 3                |     | MHz              |
| Total Harmonic Distortion                     | THD                          | R <sub>AB</sub> = 100 kΩ   |      | 0.43             |     | MHz              |
|   |                              | V <sub>DD</sub> /V <sub>SS</sub> = ±2.5 V, V <sub>A</sub> = 1 V rms, V <sub>B</sub> = 0 V, f = 1 kHz |      |                  |     |                  |
|   |                              | R <sub>AB</sub> = 10 kΩ  |      | -80              |     | dB               |
| Resistor Noise Density                        | e <sub>N_WB</sub>            | R <sub>AB</sub> = 100 kΩ   |      | -90              |     | dB               |
|   |                              | Code = half scale, T <sub>A</sub> = 25°C, f = 10 kHz   |      |                  |     |                  |
|   |                              | R <sub>AB</sub> = 10 kΩ  |      | 7                |     | nV/√Hz           |
| V <sub>W</sub> Settling Time                  | t <sub>s</sub>               | R <sub>AB</sub> = 100 kΩ   |      | 20               |     | nV/√Hz           |
|   |                              | V <sub>A</sub> = 5 V, V <sub>B</sub> = 0 V, from zero scale to full scale, ±0.5 LSB error band       |      |                  |     |                  |
|   |                              | R <sub>AB</sub> = 10 kΩ  |      | 2                |     | μs               |
| Crosstalk (C <sub>W1</sub> /C <sub>W2</sub> ) | C <sub>T</sub>               | R <sub>AB</sub> = 100 kΩ   |      | 12               |     | μs               |
|   |                              | R <sub>AB</sub> = 10 kΩ  |      | 10               |     | nV-sec           |
|   |                              | R <sub>AB</sub> = 100 kΩ   |      | 25               |     | nV-sec           |
| Analog Crosstalk                              | C <sub>TA</sub>              |  |      | -90              |     | dB               |
| Endurance <sup>10</sup>                       |                              | T <sub>A</sub> = 25°C  |      | 1                |     | Mcycles          |
| Data Retention <sup>11, 12</sup>              |                              |  | 100  | 50               |     | kcycles<br>Years |

<sup>1</sup> Typical values represent average readings at 25°C, V<sub>DD</sub> = 5 V, V<sub>SS</sub> = 0 V, and V<sub>LOGIC</sub> = 5 V.

<sup>2</sup> Resistor integral nonlinearity (R-INL) error is the deviation from an ideal value measured between the maximum resistance and the minimum resistance wiper positions. R-DNL measures the relative step change from ideal between successive tap positions. The maximum wiper current is limited to (0.7 × V<sub>DD</sub>)/R<sub>AB</sub>.

<sup>3</sup> Guaranteed by design and characterization, not subject to production test.

<sup>4</sup> INL and DNL are measured at V<sub>WB</sub> with the RDAC configured as a potentiometer divider similar to a voltage output DAC. V<sub>A</sub> = V<sub>DD</sub> and V<sub>B</sub> = 0 V. DNL specification limits of ±1 LSB maximum are guaranteed monotonic operating conditions.

<sup>5</sup> Resistor Terminal A, Resistor Terminal B, and Resistor Terminal W have no limitations on polarity with respect to each other. Dual-supply operation enables ground referenced bipolar signal adjustment.

<sup>6</sup> Different from operating current; supply current for EEPROM program lasts approximately 30 ms.

<sup>7</sup> Different from operating current; supply current for EEPROM read lasts approximately 20 μs.

<sup>8</sup> P<sub>DISS</sub> is calculated from (I<sub>DD</sub> × V<sub>DD</sub>) + (I<sub>LOGIC</sub> × V<sub>LOGIC</sub>).

<sup>9</sup> All dynamic characteristics use V<sub>DD</sub>/V<sub>SS</sub> = ±2.5 V, and V<sub>LOGIC</sub> = 2.5 V.

<sup>10</sup> Endurance is qualified to 100,000 cycles per JEDEC Standard 22, Method A117 and measured at -40°C to +125°C.

<sup>11</sup> Retention lifetime equivalent at junction temperature (T<sub>J</sub>) = 125°C per JEDEC Standard 22, Method A117. Retention lifetime, based on an activation energy of 1 eV, derates with junction temperature in the Flash/EE memory.

<sup>12</sup> 50 years apply to an endurance of 1000 cycles. An endurance of 100,000 cycles has an equivalent retention lifetime of 5 years.

## SPECIFICATIONS

## INTERFACE TIMING SPECIFICATIONS

$V_{\text{LOGIC}} = 1.8 \text{ V to } 5.5 \text{ V}$ ; all specifications  $T_{\text{MIN}}$  to  $T_{\text{MAX}}$ , unless otherwise noted.

Table 4.

| Parameter <sup>1</sup>         | Test Conditions/Comments | Min            | Typ  | Max  | Unit          | Description  |
|--------------------------------|--------------------------|----------------|------|------|---------------|--|
| $f_{\text{SCL}}^2$             | Standard mode            |                |      | 100  | kHz           | Serial clock frequency   |
|                                | Fast mode                |                |      | 400  | kHz           |  |
| $t_1$                          | Standard mode            | 4.0            |      |      | $\mu\text{s}$ | SCL high time, $t_{\text{HIGH}}$   |
|                                | Fast mode                | 0.6            |      |      | $\mu\text{s}$ |  |
| $t_2$                          | Standard mode            | 4.7            |      |      | $\mu\text{s}$ | SCL low time, $t_{\text{LOW}}$   |
|                                | Fast mode                | 1.3            |      |      | $\mu\text{s}$ |  |
| $t_3$                          | Standard mode            | 250            |      |      | ns            | Data setup time, $t_{\text{SU; DAT}}$  |
|                                | Fast mode                | 100            |      |      | ns            |  |
| $t_4$                          | Standard mode            | 0              | 3.45 |      | $\mu\text{s}$ | Data hold time, $t_{\text{HD; DAT}}$   |
|                                | Fast mode                | 0              | 0.9  |      | $\mu\text{s}$ |  |
| $t_5$                          | Standard mode            | 4.7            |      |      | $\mu\text{s}$ | Setup time for a repeated start condition, $t_{\text{SU; STA}}$  |
|                                | Fast mode                | 0.6            |      |      | $\mu\text{s}$ |  |
| $t_6$                          | Standard mode            | 4              |      |      | $\mu\text{s}$ | Hold time (repeated) for a start condition, $t_{\text{HD; STA}}$   |
|                                | Fast mode                | 0.6            |      |      | $\mu\text{s}$ |  |
| $t_7$                          | Standard mode            | 4.7            |      |      | $\mu\text{s}$ | Bus free time between a stop and a start condition, $t_{\text{BUF}}$   |
|                                | Fast mode                | 1.3            |      |      | $\mu\text{s}$ |  |
| $t_8$                          | Standard mode            | 4              |      |      | $\mu\text{s}$ | Setup time for a stop condition, $t_{\text{SU; STO}}$  |
|                                | Fast mode                | 0.6            |      |      | $\mu\text{s}$ |  |
| $t_9$                          | Standard mode            |                |      | 1000 | ns            | Rise time of SDA signal, $t_{\text{RDA}}$  |
|                                | Fast mode                | $20 + 0.1 C_L$ |      | 300  | ns            |  |
| $t_{10}$                       | Standard mode            |                |      | 300  | ns            | Fall time of SDA signal, $t_{\text{FDA}}$  |
|                                | Fast mode                | $20 + 0.1 C_L$ |      | 300  | ns            |  |
| $t_{11}$                       | Standard mode            |                |      | 1000 | ns            | Rise time of SCL signal, $t_{\text{RCL}}$  |
|                                | Fast mode                | $20 + 0.1 C_L$ |      | 300  | ns            |  |
| $t_{11A}$                      | Standard mode            |                |      | 1000 | ns            | Rise time of SCL signal after a repeated start condition and after an acknowledge bit, $t_{\text{RCL1}}$ (not shown in Figure 3) |
|                                | Fast mode                | $20 + 0.1 C_L$ |      | 300  | ns            |  |
| $t_{12}$                       | Standard mode            |                |      | 300  | ns            | Fall time of SCL signal, $t_{\text{FCL}}$  |
|                                | Fast mode                | $20 + 0.1 C_L$ |      | 300  | ns            |  |
| $t_{\text{SP}}^3$              | Fast mode                | 0              |      | 50   | ns            | Pulse width of suppressed spike (not shown in Figure 3)  |
| $t_{\text{RESET}}$             | 0.1                      |                |      | 10   | $\mu\text{s}$ | RESET low time (not shown in Figure 3)   |
| $t_{\text{EEPROM\_PROGRAM}}^4$ |                          |                | 15   | 50   | ms            | Memory program time (not shown in Figure 3)  |
| $t_{\text{EEPROM\_READBACK}}$  |                          |                | 7    | 30   | $\mu\text{s}$ | Memory readback time (not shown in Figure 3)   |
| $t_{\text{POWER\_UP}}^5$       |                          |                |      | 75   | $\mu\text{s}$ | Power-on EEPROM restore time (not shown in Figure 3)   |
| $t_{\text{RESET}}$             |                          |                | 30   |      | $\mu\text{s}$ | Reset EEPROM restore time (not shown in Figure 3)  |

<sup>1</sup> Maximum bus capacitance is limited to 400 pF.

<sup>2</sup> The SDA and SCL timing is measured with the input filters enabled. Switching off the input filters improves the transfer rate; however, it has a negative effect on the EMC behavior of the part.

<sup>3</sup> Input filtering on the SCL and SDA inputs suppresses noise spikes that are less than 50 ns for fast mode.

<sup>4</sup> The EEPROM program time depends on the temperature and EEPROM write cycles. Higher timing is expected at lower temperatures and higher write cycles.

<sup>5</sup> Maximum time after  $V_{\text{DD}} - V_{\text{SS}}$  is equal to 2.3 V.



SPECIFICATIONS

SHIFT REGISTER AND TIMING DIAGRAMS

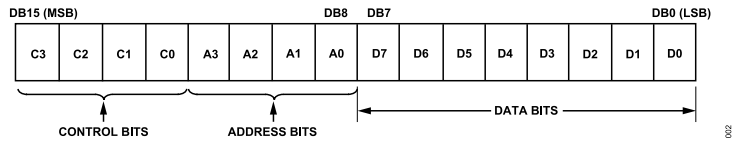

Figure 2. Input Shift Register Contents

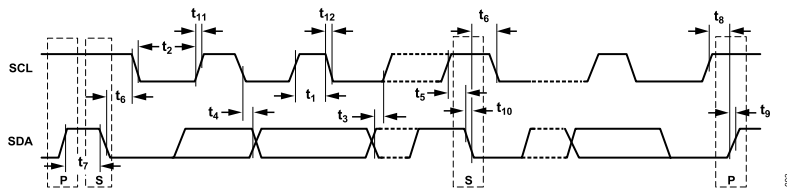

Figure 3. I<sup>2</sup>C Serial Interface Timing Diagram (Typical Write Sequence)

## ABSOLUTE MAXIMUM RATINGS

$T_A = 25^\circ\text{C}$ , unless otherwise noted.

Table 5.

| Parameter                                       | Rating   |
|---|--|
| $V_{DD}$ to GND                                 | -0.3 V to +7.0 V   |
| $V_{SS}$ to GND                                 | +0.3 V to -7.0 V   |
| $V_{DD}$ to $V_{SS}$                            | 7 V  |
| $V_{LOGIC}$ to GND                              | -0.3 V to $V_{DD} + 0.3$ V or<br>+7.0 V (whichever is less)      |
| $V_A, V_W, V_B$ to GND                          | $V_{SS} - 0.3$ V, $V_{DD} + 0.3$ V<br>+7.0 V (whichever is less) |
| $I_A, I_W, I_B$<br>Pulsed <sup>1</sup>          |  |
| Frequency > 10 kHz <sup>2</sup>                 |  |
| $R_{AW} = 10$ k $\Omega$                        | $\pm 6$ mA/d   |
| $R_{AW} = 100$ k $\Omega$                       | $\pm 1.5$ mA/d   |
| Frequency $\leq 10$ kHz <sup>2</sup>            |  |
| $R_{AW} = 10$ k $\Omega$                        | $\pm 6$ mA/ $\sqrt{d}$   |
| $R_{AW} = 100$ k $\Omega$                       | $\pm 1.5$ mA/ $\sqrt{d}$   |
| Digital Inputs                                  | -0.3 V to $V_{LOGIC} + 0.3$ V or<br>+7 V (whichever is less)     |
| Operating Temperature Range, $T_A$ <sup>3</sup> | -40°C to +125°C  |
| Maximum Junction Temperature,<br>$T_J$ Maximum  | 150°C  |
| Storage Temperature Range                       | -65°C to +150°C  |
| Reflow Soldering                                |  |
| Peak Temperature                                | 260°C  |
| Time at Peak Temperature                        | 20 sec to 40 sec   |
| Package Power Dissipation                       | $(T_J \text{ max} - T_A)/\theta_{JA}$                            |

<sup>1</sup> Maximum terminal current is bounded by the maximum current handling of the switches, maximum power dissipation of the package, and maximum applied voltage across any two of the A, B, and W terminals at a given resistance.

<sup>2</sup> d = pulse duty factor.

<sup>3</sup> Includes programming of EEPROM memory.

Stresses at or above those listed under Absolute Maximum Ratings may cause permanent damage to the product. This is a stress rating only; functional operation of the product at these or any other conditions above those indicated in the operational section of this specification is not implied. Operation beyond the maximum operating conditions for extended periods may affect product reliability.

## THERMAL RESISTANCE

$\theta_{JA}$  is defined by the JEDEC JESD51 standard, and the value is dependent on the test board and test environment.

Table 6. Thermal Resistance

| Package Type  | $\theta_{JA}$      | $\theta_{JC}$ | Unit |
|---------------|--------------------|---------------|------|
| 16-Lead LFCSP | 89.5 <sup>1</sup>  | 3             | °C/W |
| 16-Lead TSSOP | 150.4 <sup>1</sup> | 27.6          | °C/W |

<sup>1</sup> JEDEC 2S2P test board, still air (0 m/sec airflow).

## ELECTROSTATIC DISCHARGE (ESD) RATINGS

The following ESD information is provided for handling of ESD-sensitive devices in and ESD-protected area only.

Human body model (HBM) per ANSI/ESDA/JEDEC JS-001.

Field induced charged device model (FICDM) and charged device model (CDM) per ANSI/ESDA/JEDEC JS-002.

## ESD RATINGS FOR AD5122A/AD5142A

Table 7. AD5122A/AD5142A, 16-Lead TSSOP and 16-Lead LFCSP

| ESD Model | Withstand Threshold |       |
|-----------|---------------------|-------|
|           | (V)                 | Class |
| HBM       | 4000                | 3A    |
| FICDM     | 1250                | C3    |

Table 8. AD5122AW/AD5142AW, 16-Lead LFCSP

| ESD Model | Withstand Threshold |       |
|-----------|---------------------|-------|
|           | (V)                 | Class |
| HBM       | 2000                | 2     |
| FICDM     | 1250                | C3    |

## ESD CAUTION



**ESD (electrostatic discharge) sensitive device.** Charged devices and circuit boards can discharge without detection. Although this product features patented or proprietary protection circuitry, damage may occur on devices subjected to high energy ESD. Therefore, proper ESD precautions should be taken to avoid performance degradation or loss of functionality.

PIN CONFIGURATIONS AND FUNCTION DESCRIPTIONS

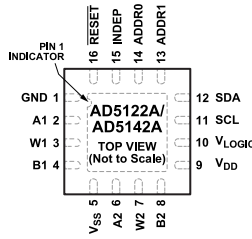

NOTES  
 1. EXPOSED PAD. CONNECT THE EXPOSED PAD TO THE POTENTIAL OF THE  $V_{SS}$  PIN, OR, ALTERNATIVELY, LEAVE IT ELECTRICALLY UNCONNECTED. IT IS RECOMMENDED THAT THE PAD BE THERMALLY CONNECTED TO A COPPER PLANE FOR ENHANCED THERMAL PERFORMANCE.

Figure 4. 16-Lead LFCSP Pin Configuration

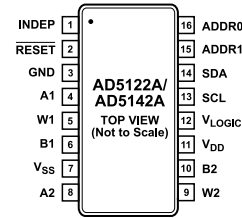

Figure 5. 16-Lead TSSOP Pin Configuration

Table 9. Pin Function Descriptions

| Pin No.       |               | Mnemonic    | Description   |
|---------------|---------------|-------------|---|
| 16-Lead LFCSP | 16-Lead TSSOP |             |   |
| 1             | 3             | GND         | Ground Pin, Logic Ground Reference.   |
| 2             | 4             | A1          | Terminal A of RDAC1. $V_{SS} \leq V_A \leq V_{DD}$ .  |
| 3             | 5             | W1          | Wiper Terminal of RDAC1. $V_{SS} \leq V_W \leq V_{DD}$ .  |
| 4             | 6             | B1          | Terminal B of RDAC1. $V_{SS} \leq V_B \leq V_{DD}$ .  |
| 5             | 7             | $V_{SS}$    | Negative Power Supply. Decouple this pin with 0.1 $\mu$ F ceramic capacitors and 10 $\mu$ F capacitors.   |
| 6             | 8             | A2          | Terminal A of RDAC2. $V_{SS} \leq V_A \leq V_{DD}$ .  |
| 7             | 9             | W2          | Wiper Terminal of RDAC2. $V_{SS} \leq V_W \leq V_{DD}$ .  |
| 8             | 10            | B2          | Terminal B of RDAC2. $V_{SS} \leq V_B \leq V_{DD}$ .  |
| 9             | 11            | $V_{DD}$    | Positive Power Supply. Decouple this pin with 0.1 $\mu$ F ceramic capacitors and 10 $\mu$ F capacitors.   |
| 10            | 12            | $V_{LOGIC}$ | Logic Power Supply; 1.8 V to $V_{DD}$ . Decouple this pin with 0.1 $\mu$ F ceramic capacitors and 10 $\mu$ F capacitors.  |
| 11            | 13            | SCL         | Serial Clock Line.  |
| 12            | 14            | SDA         | Serial Data Input/Output.   |
| 13            | 15            | ADDR1       | Programmable Address (ADDR1) for Multiple Package Decoding.   |
| 14            | 16            | ADDR0       | Programmable Address (ADDR0) for Multiple Package Decoding.   |
| 15            | 1             | INDEP       | Linear Gain Setting Mode at Power-Up. Each string resistor is loaded from its associated memory location. If INDEP is enabled, it cannot be disabled by the software.   |
| 16            | 2             | RESET       | Hardware Reset Pin. Refresh the RDAC registers from EEPROM. $\overline{\text{RESET}}$ is activated at logic low. If this pin is not used, tie $\overline{\text{RESET}}$ to $V_{LOGIC}$ .  |
|               |               | EPAD        | Exposed Pad. Connect this exposed pad to the potential of the $V_{SS}$ pin, or, alternatively, leave it electrically unconnected. It is recommended that the pad be thermally connected to a copper plane for enhanced thermal performance. |

TYPICAL PERFORMANCE CHARACTERISTICS

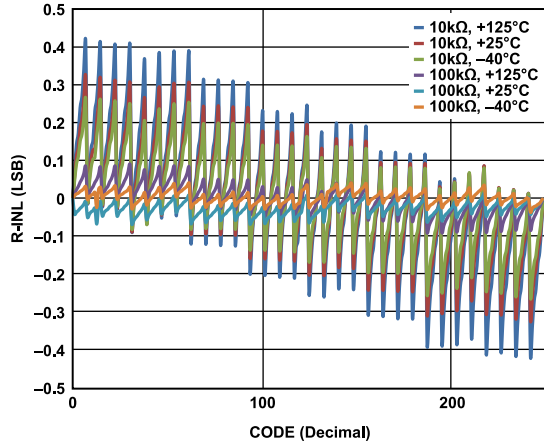

Figure 6. R-INL vs. Code (AD5142A)

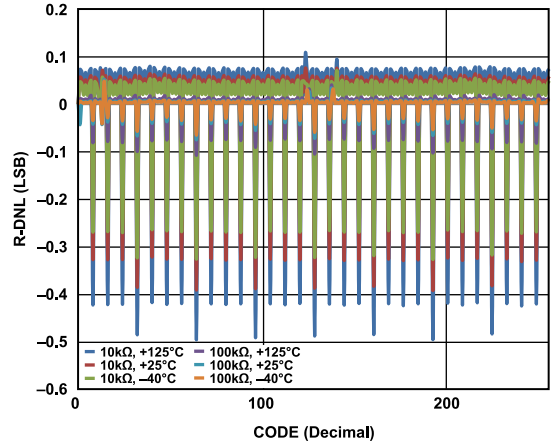

Figure 9. R-DNL vs. Code (AD5142A)

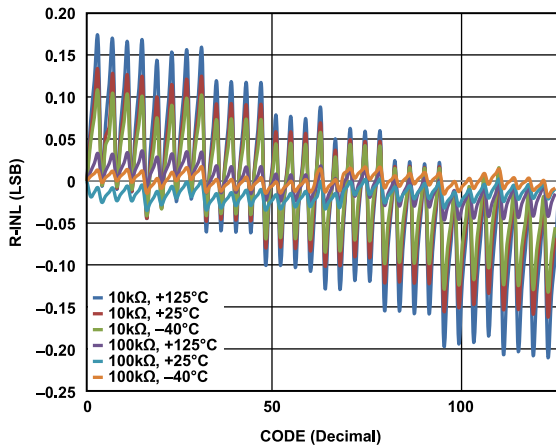

Figure 7. R-INL vs. Code (AD5122A)

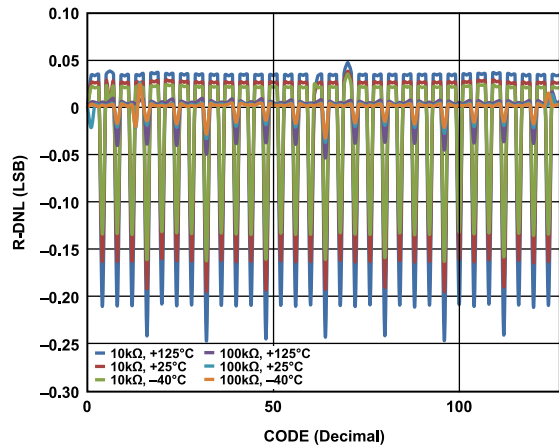

Figure 10. R-DNL vs. Code (AD5122A)

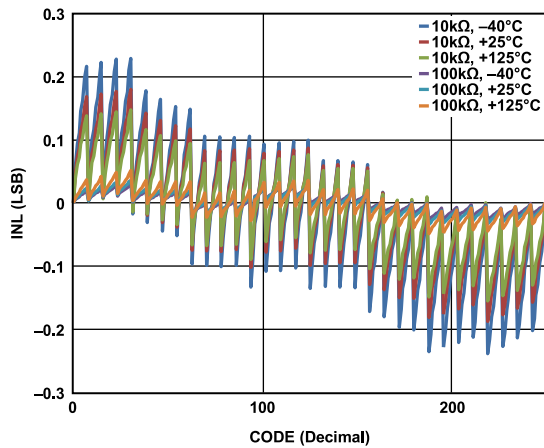

Figure 8. INL vs. Code (AD5142A)

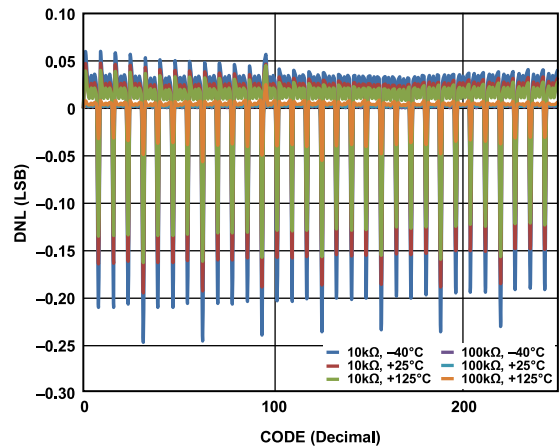

Figure 11. DNL vs. Code (AD5142A)

TYPICAL PERFORMANCE CHARACTERISTICS

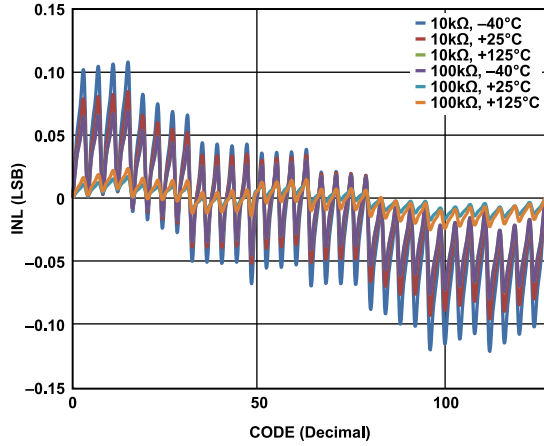

Figure 12. INL vs. Code (AD5122A)

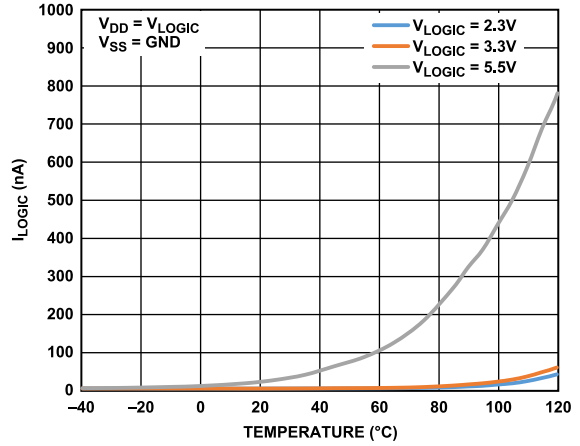

Figure 15. I<sub>LOGIC</sub> vs. Temperature

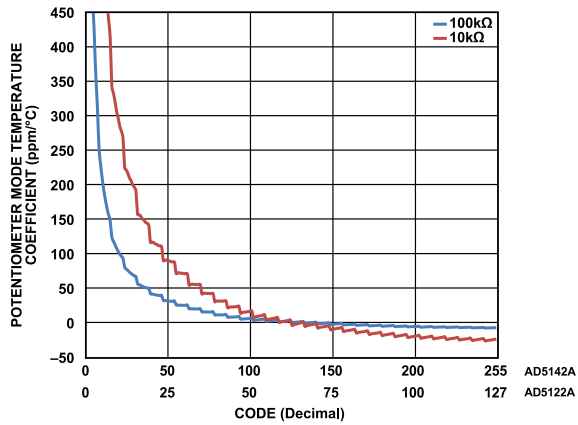

Figure 13. Potentiometer Mode Temperature Coefficient  $((\Delta V_W/V_W)/\Delta T \times 10^6)$  vs. Code

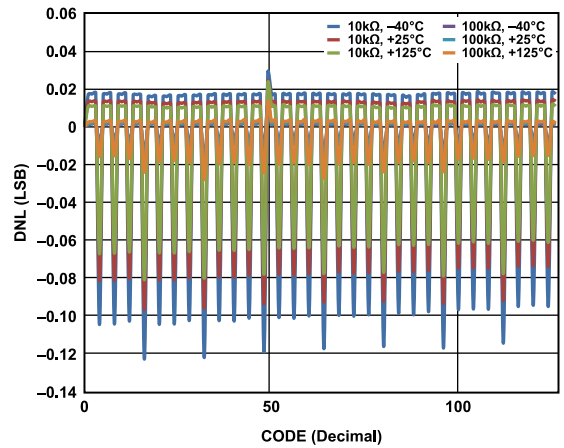

Figure 16. DNL vs. Code (AD5122A)

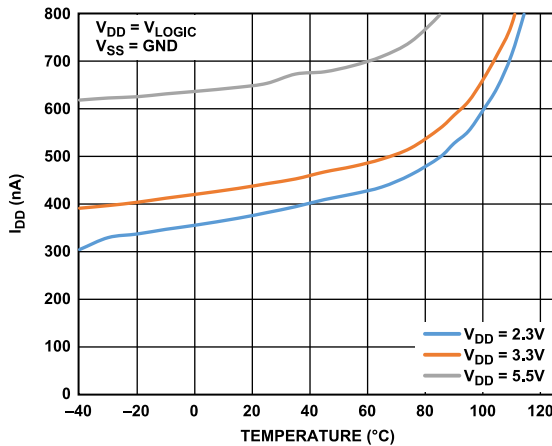

Figure 14. I<sub>DD</sub> vs. Temperature

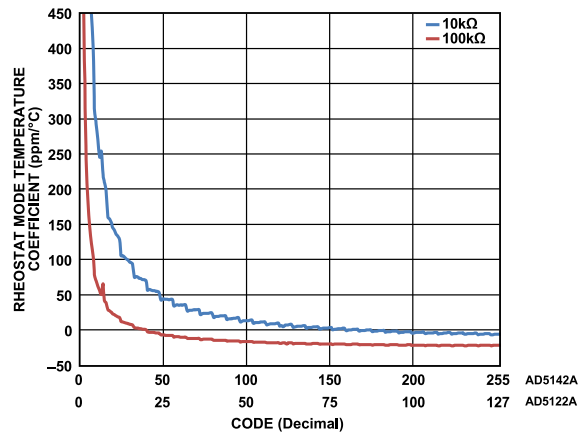

Figure 17. Rheostat Mode Temperature Coefficient  $((\Delta R_{WB}/R_{WB})/\Delta T \times 10^6)$  vs. Code

TYPICAL PERFORMANCE CHARACTERISTICS

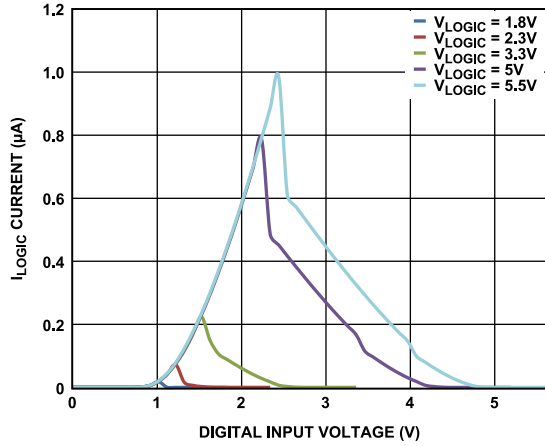

Figure 18.  $I_{LOGIC}$  Current vs. Digital Input Voltage

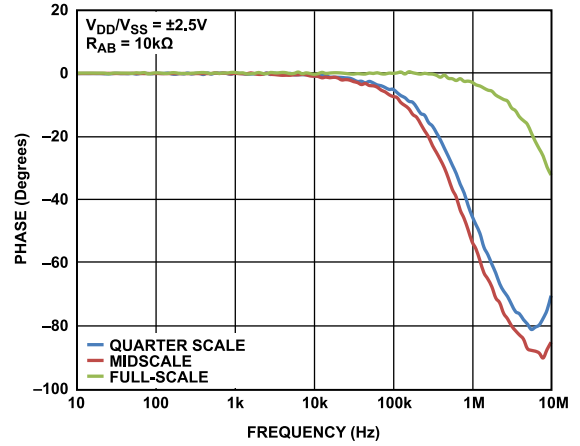

Figure 21. Normalized Phase Flatness vs. Frequency,  $R_{AB} = 10\text{ k}\Omega$

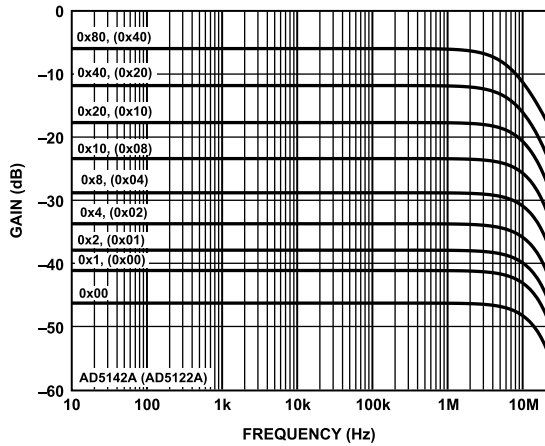

Figure 19.  $10\text{ k}\Omega$  Gain vs. Frequency and Code

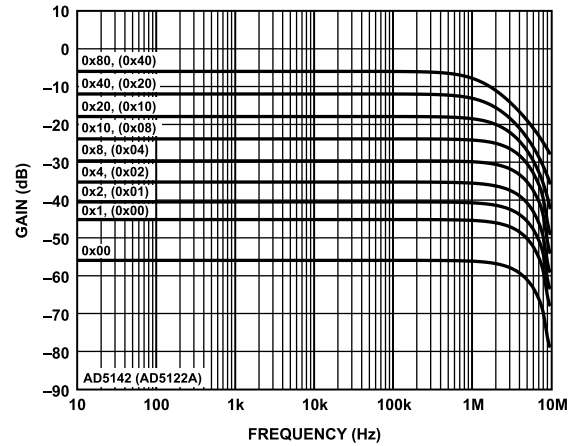

Figure 22.  $100\text{ k}\Omega$  Gain vs. Frequency and Code

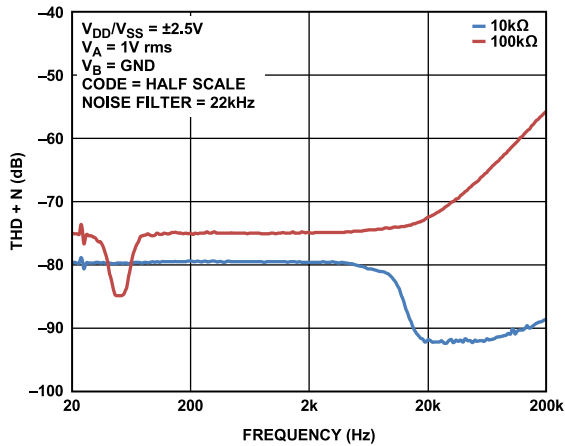

Figure 20. Total Harmonic Distortion Plus Noise (THD + N) vs. Frequency

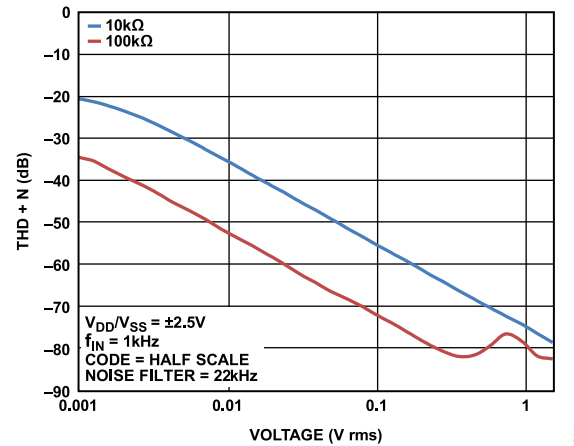

Figure 23. Total Harmonic Distortion Plus Noise (THD + N) vs. Amplitude

TYPICAL PERFORMANCE CHARACTERISTICS

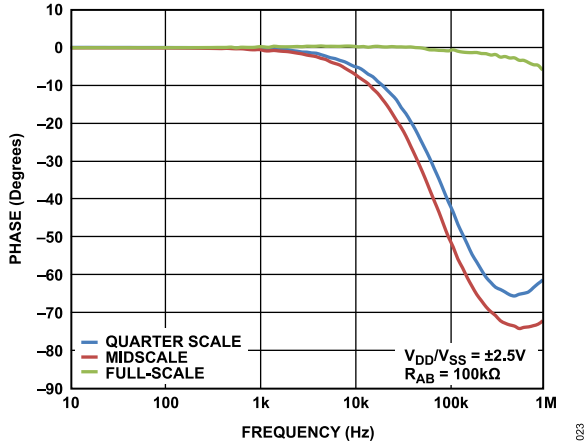

Figure 24. Normalized Phase Flatness vs. Frequency,  $R_{AB} = 100\text{ k}\Omega$

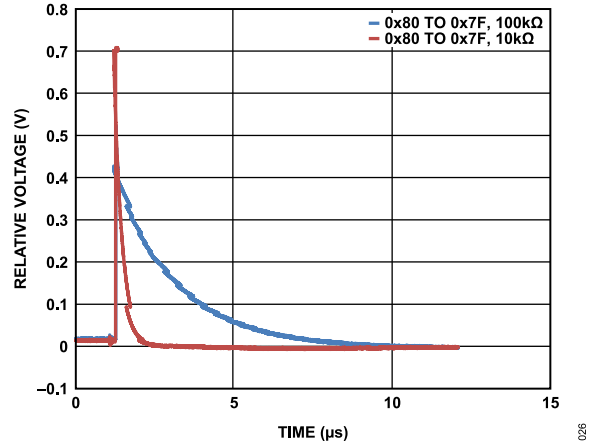

Figure 27. Maximum Transition Glitch

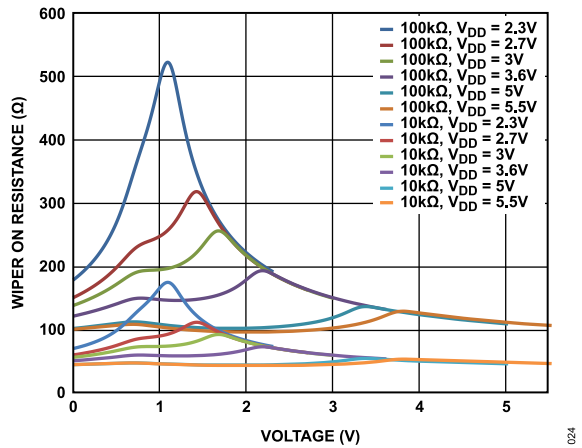

Figure 25. Incremental Wiper On Resistance vs.  $V_{DD}$

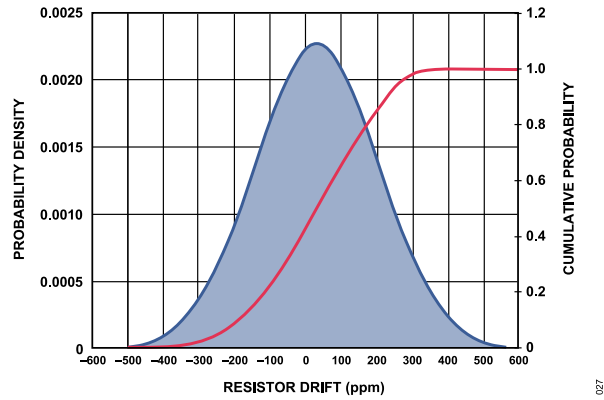

Figure 28. Resistor Lifetime Drift

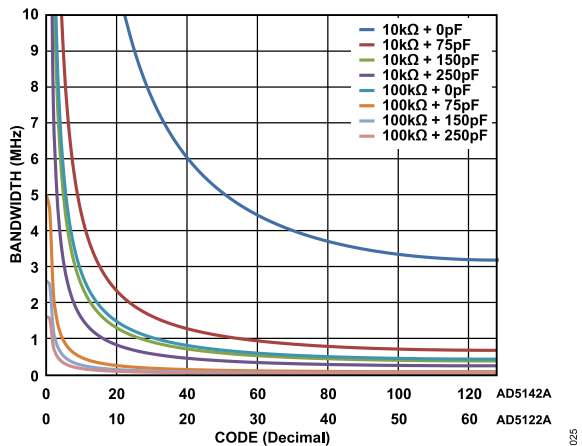

Figure 26. Maximum Bandwidth vs. Code and Net Capacitance

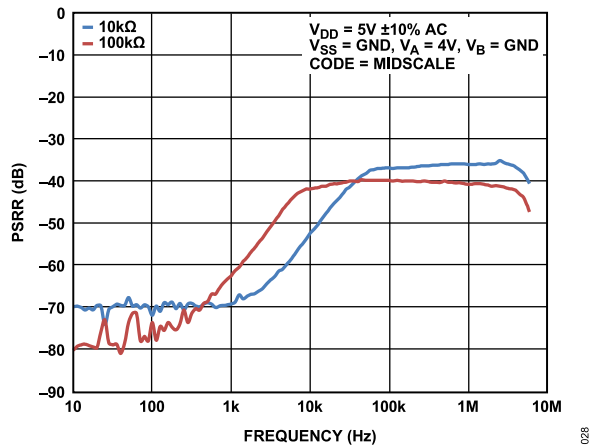

Figure 29. Power Supply Rejection Ratio (PSRR) vs. Frequency

TYPICAL PERFORMANCE CHARACTERISTICS

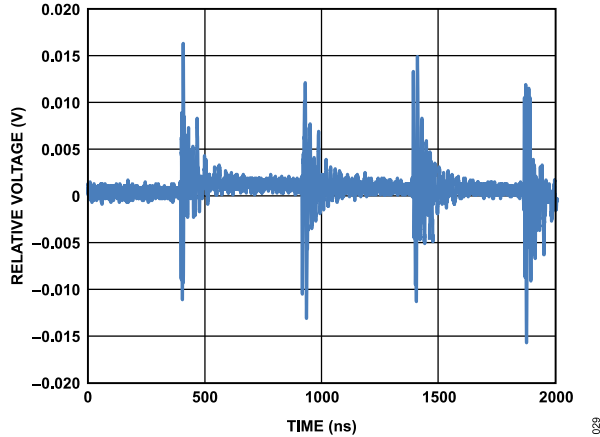

Figure 30. Digital Feedthrough

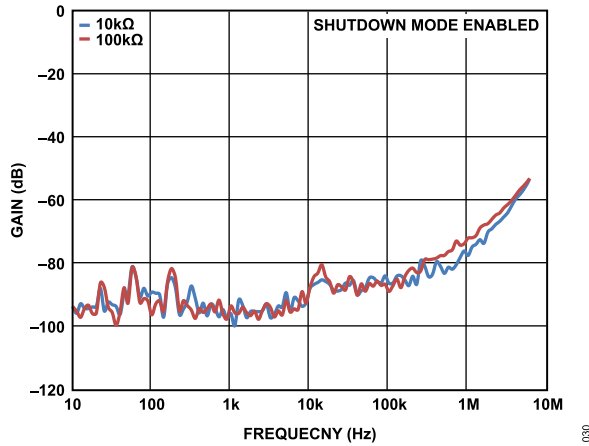

Figure 31. Shutdown Isolation vs. Frequency

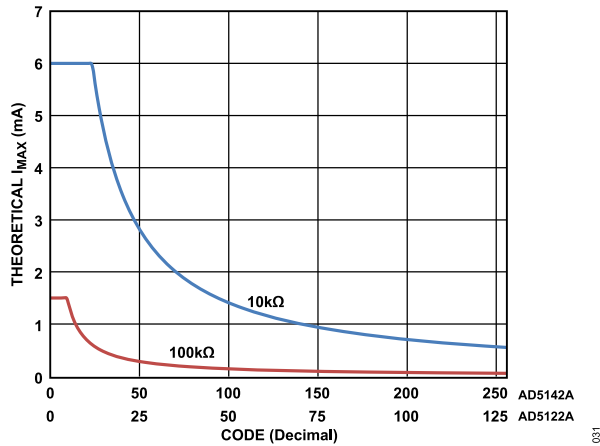

Figure 32. Theoretical Maximum Current vs. Code



TEST CIRCUITS

Figure 33 to Figure 37 define the test conditions used in the Specifications section.

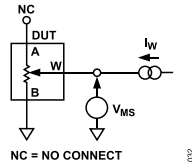

Figure 33. Resistor Integral Nonlinearity Error (Rheostat Operation; R-INL, R-DNL)

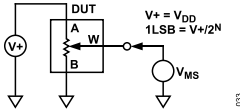

Figure 34. Potentiometer Divider Nonlinearity Error (INL, DNL)

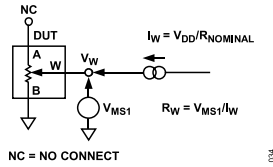

Figure 35. Wiper Resistance

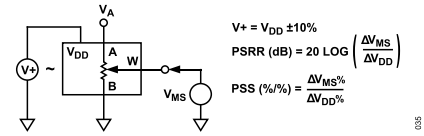

Figure 36. Power Supply Sensitivity and Power Supply Rejection Ratio (PSS, PSRR)

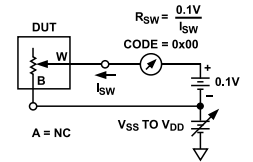

Figure 37. Incremental On Resistance

## THEORY OF OPERATION

The AD5122A/AD5142A digital programmable potentiometers are designed to operate as true variable resistors for analog signals within the terminal voltage range of  $V_{SS} < V_{TERM} < V_{DD}$ . The resistor wiper position is determined by the RDAC register contents. The RDAC register acts as a scratchpad register that allows unlimited changes of resistance settings. A secondary register (the input shift register) can be used to preload the RDAC register data.

The RDAC register can be programmed with any position setting using the I<sup>2</sup>C interface. When a desirable wiper position is found, this value can be stored in the EEPROM memory. Thereafter, the wiper position is always restored to that position for subsequent power-ups. The storing of EEPROM data takes approximately 15 ms; during this time, the device is locked and does not acknowledge any new command, preventing any changes from taking place.

### RDAC REGISTER AND EEPROM

The RDAC register directly controls the position of the digital potentiometer wiper. For example, when the RDAC register is loaded with 0x80 (AD5142A, 256 taps), the wiper is connected to half scale of the variable resistor. The RDAC register is a standard logic register; there is no restriction on the number of changes allowed.

It is possible to both write to and read from the RDAC register using the digital interface (see Table 10).

The contents of the RDAC register can be stored to the EEPROM using Command 9 (see Table 10). Thereafter, the RDAC register always sets at that position for any future on-off-on power supply sequence. It is possible to read back data saved into the EEPROM with Command 3 (see Table 10).

Alternatively, the EEPROM can be written to independently using Command 11 (see Table 13).

### INPUT SHIFT REGISTER

For the AD5122A/AD5142A, the input shift register is 16 bits wide, as shown in Figure 2. The 16-bit word consists of four control bits, followed by four address bits and by eight data bits.

If the AD5122A RDAC or EEPROM registers are read from or written to, the lowest data bit (Bit 0) is ignored.

Data is loaded MSB first (Bit 15). The four control bits determine the function of the software command, as listed in Table 10 and Table 13.

Table 10. Reduced Commands Operation Truth Table

| Command Number | Control Bits[DB15:DB12] |        |    |    | Address Bits[DB11:DB8] <sup>1</sup> |    |    |    | Data Bits[DB7:DB0] <sup>1</sup> |    |    |    |    |    |    |    | Operation  |    |           |      |             |   |               |   |   |      |
|----------------|-------------------------|--------|----|----|-------------------------------------|----|----|----|---------------------------------|----|----|----|----|----|----|----|--|----|-----------|------|-------------|---|---------------|---|---|------|
|                | C3                      | C2     | C1 | C0 | A3                                  | A2 | A1 | A0 | D7                              | D6 | D5 | D4 | D3 | D2 | D1 | D0 |  |    |           |      |             |   |               |   |   |      |
| 0              | 0                       | 0      | 0  | 0  | X                                   | X  | X  | X  | X                               | X  | X  | X  | X  | X  | X  | X  | NOP: do nothing  |    |           |      |             |   |               |   |   |      |
| 1              | 0                       | 0      | 0  | 1  | 0                                   | 0  | 0  | A0 | D7                              | D6 | D5 | D4 | D3 | D2 | D1 | D0 | Write contents of serial register data to RDAC   |    |           |      |             |   |               |   |   |      |
| 2              | 0                       | 0      | 1  | 0  | 0                                   | 0  | 0  | A0 | D7                              | D6 | D5 | D4 | D3 | D2 | D1 | D0 | Write contents of serial register data to input shift register   |    |           |      |             |   |               |   |   |      |
| 3              | 0                       | 0      | 1  | 1  | 0                                   | 0  | A1 | A0 | X                               | X  | X  | X  | X  | X  | D1 | D0 | Read back contents   |    |           |      |             |   |               |   |   |      |
|                |                         |        |    |    |                                     |    |    |    |                                 |    |    |    |    |    |    |    | <table border="1"> <thead> <tr> <th>D1</th> <th>D0</th> <th>Data</th> </tr> </thead> <tbody> <tr> <td>0</td> <td>1</td> <td>EEPROM</td> </tr> <tr> <td>1</td> <td>1</td> <td>RDAC</td> </tr> </tbody> </table> | D1 | D0        | Data | 0           | 1 | EEPROM        | 1 | 1 | RDAC |
| D1             | D0                      | Data   |    |    |                                     |    |    |    |                                 |    |    |    |    |    |    |    |  |    |           |      |             |   |               |   |   |      |
| 0              | 1                       | EEPROM |    |    |                                     |    |    |    |                                 |    |    |    |    |    |    |    |  |    |           |      |             |   |               |   |   |      |
| 1              | 1                       | RDAC   |    |    |                                     |    |    |    |                                 |    |    |    |    |    |    |    |  |    |           |      |             |   |               |   |   |      |
| 9              | 0                       | 1      | 1  | 1  | 0                                   | 0  | 0  | A0 | X                               | X  | X  | X  | X  | X  | X  | 1  | Copy RDAC register to EEPROM   |    |           |      |             |   |               |   |   |      |
| 10             | 0                       | 1      | 1  | 1  | 0                                   | 0  | 0  | A0 | X                               | X  | X  | X  | X  | X  | X  | 0  | Copy EEPROM into RDAC  |    |           |      |             |   |               |   |   |      |
| 14             | 1                       | 0      | 1  | 1  | X                                   | X  | X  | X  | X                               | X  | X  | X  | X  | X  | X  | X  | Software reset   |    |           |      |             |   |               |   |   |      |
| 15             | 1                       | 1      | 0  | 0  | A3                                  | 0  | 0  | A0 | X                               | X  | X  | X  | X  | X  | X  | D0 | Software shutdown  |    |           |      |             |   |               |   |   |      |
|                |                         |        |    |    |                                     |    |    |    |                                 |    |    |    |    |    |    |    | <table border="1"> <thead> <tr> <th>D0</th> <th>Condition</th> </tr> </thead> <tbody> <tr> <td>0</td> <td>Normal mode</td> </tr> <tr> <td>1</td> <td>Shutdown mode</td> </tr> </tbody> </table>                | D0 | Condition | 0    | Normal mode | 1 | Shutdown mode |   |   |      |
| D0             | Condition               |        |    |    |                                     |    |    |    |                                 |    |    |    |    |    |    |    |  |    |           |      |             |   |               |   |   |      |
| 0              | Normal mode             |        |    |    |                                     |    |    |    |                                 |    |    |    |    |    |    |    |  |    |           |      |             |   |               |   |   |      |
| 1              | Shutdown mode           |        |    |    |                                     |    |    |    |                                 |    |    |    |    |    |    |    |  |    |           |      |             |   |               |   |   |      |

<sup>1</sup> X = don't care.

Table 11. Reduced Address Bits Table

| A3 | A2             | A1             | A0             | Channel      | Stored Channel Memory |
|----|----------------|----------------|----------------|--------------|-----------------------|
| 1  | X <sup>1</sup> | X <sup>1</sup> | X <sup>1</sup> | All channels | Not applicable        |
| 0  | 0              | 0              | 0              | RDAC1        | RDAC1                 |
| 0  | 0              | 0              | 1              | RDAC2        | Not applicable        |

## THEORY OF OPERATION

Table 11. Reduced Address Bits Table

| A3 | A2 | A1 | A0 | Channel        | Stored Channel Memory |
|----|----|----|----|----------------|-----------------------|
| 0  | 0  | 1  | 0  | Not applicable | RDAC2                 |

<sup>1</sup> X = don't care.

### I<sup>2</sup>C SERIAL DATA INTERFACE

The AD5122A/AD5142A have 2-wire, I<sup>2</sup>C-compatible serial interfaces. The device can be connected to an I<sup>2</sup>C bus as a slave device, under the control of a master device. See [Figure 3](#) for a timing diagram of a typical write sequence.

The AD5122A/AD5142A supports standard (100 kHz) and fast (400 kHz) data transfer modes. Support is not provided for 10-bit addressing and general call addressing.

The 2-wire serial bus protocol operates as follows:

1. The master initiates a data transfer by establishing a start condition, which is when a high-to-low transition on the SDA line occurs while SCL is high. The following byte is the address byte, which consists of the 7-bit slave address and an R/ $\bar{W}$  bit. The slave device corresponding to the transmitted address responds by pulling SDA low during the ninth clock pulse (this is called the acknowledge bit). At this stage, all other devices on the bus remain idle while the selected device waits for data to be written to, or read from, its shift register. If the R/ $\bar{W}$  bit is set high, the master reads from the slave device. However, if the R/ $\bar{W}$  bit is set low, the master writes to the slave device.
2. Data is transmitted over the serial bus in sequences of nine clock pulses (eight data bits followed by an acknowledge bit). The transitions on the SDA line must occur during the low period of SCL and remain stable during the high period of SCL.
3. When all data bits have been read from or written to, a stop condition is established. In write mode, the master pulls the SDA line high during the tenth clock pulse to establish a stop condition. In read mode, the master issues a no acknowledge for the ninth clock pulse (that is, the SDA line remains high). The master then brings the SDA line low before the tenth clock pulse, and then high again during the tenth clock pulse to establish a stop condition.

### I<sup>2</sup>C Address

The facility to make hardwired changes to ADDR allows the user to incorporate up to nine of these devices on one bus as outlined in [Table 12](#).

Table 12. Device Address Selection

| ADDR0 Pin               | ADDR1 Pin               | 7-Bit I <sup>2</sup> C Device Address |
|-------------------------|-------------------------|---------------------------------------|
| V <sub>LOGIC</sub>      | V <sub>LOGIC</sub>      | 0100000                               |
| No connect <sup>1</sup> | V <sub>LOGIC</sub>      | 0100010                               |
| GND                     | V <sub>LOGIC</sub>      | 0100011                               |
| V <sub>LOGIC</sub>      | No connect <sup>1</sup> | 0101000                               |
| No connect <sup>1</sup> | No connect <sup>1</sup> | 0101010                               |
| GND                     | No connect <sup>1</sup> | 0101011                               |
| V <sub>LOGIC</sub>      | GND                     | 0101100                               |
| No connect <sup>1</sup> | GND                     | 0101110                               |
| GND                     | GND                     | 0101111                               |

<sup>1</sup> Not available in bipolar mode ( $V_{SS} < 0$  V) or in low voltage mode ( $V_{LOGIC} = 1.8$  V).

### Write Operation

When writing to the AD5122A/AD5142A, the user must begin with a start command followed by an address byte (R/ $\bar{W}$  = 0), after which the device acknowledges that it is prepared to receive data by pulling SDA low.

Two bytes of data are then written to the DAC, the most significant byte followed by the least significant byte. Both of these data bytes are acknowledged by the AD5122A/AD5142A. A stop condition follows. The write operations for the AD5122A/AD5142A are shown in [Figure 38](#).

A repeated write function gives the user flexibility to update the device a number of times after addressing the device only once, as shown in [Figure 39](#).

THEORY OF OPERATION

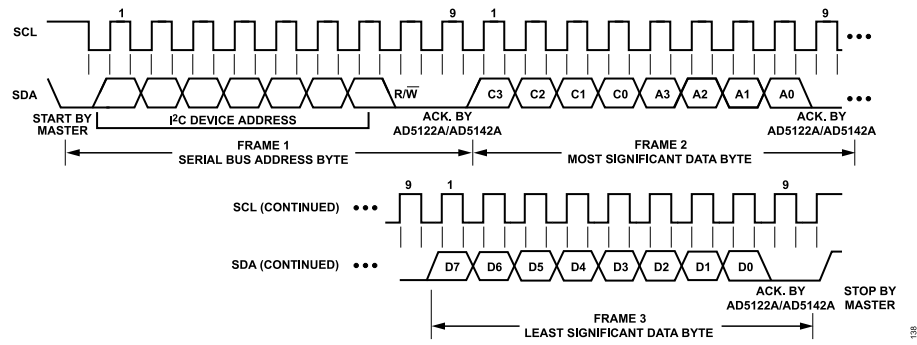

Figure 38. AD5122A/AD5142A Interface Write Command

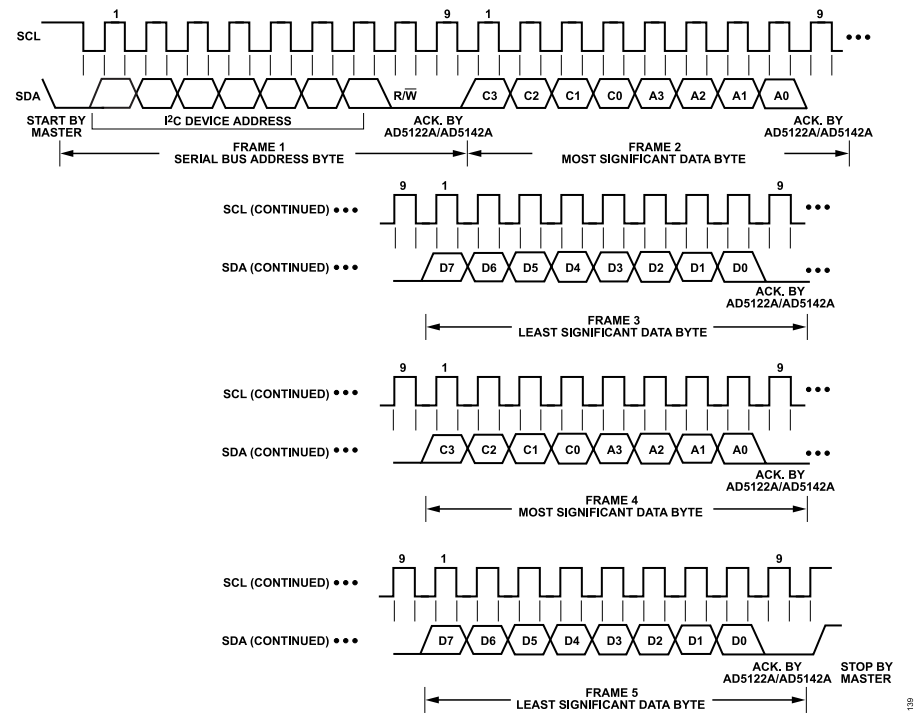

Figure 39. AD5122A/AD5142A Interface Multiple Write

**THEORY OF OPERATION**

**EEPROM Write Acknowledge Polling**

After each write operation to the EEPROM, an internal write cycle begins. The I<sup>2</sup>C interface of the device is disabled. To determine if the internal write cycle is complete and the I<sup>2</sup>C interface is enabled, interface polling can be executed. I<sup>2</sup>C interface polling can be conducted by sending a start condition, followed by the slave address and the write bit. If the I<sup>2</sup>C interface responds with an acknowledge, the write cycle is complete, and the interface is ready to proceed with further operations. Otherwise, I<sup>2</sup>C interface polling can be repeated until it succeeds.

**Read Operation**

The AD5122A/AD5142A allow readback of the contents of the RDAC register and EEPROM memory through the I<sup>2</sup>C interface by using Command 3 (see Table 13).

When reading data back from the AD5122A/AD5142A, the user must first issue a readback command to the device. The readback

command begins with a start command, followed by an address byte (R/W = 0), after which the device acknowledges that it is prepared to receive data by pulling SDA low.

Two bytes of data are then written to the AD5122A/AD5142A, the most significant byte followed by the least significant byte. Both of these data bytes are acknowledged by the AD5122A/AD5142A. A stop condition follows. These bytes contain the read instruction, which enables readback of the RDAC register and EEPROM memory. The user can then read back the data. The readback begins with a start command followed by an address byte (R/W = 1), after which the device acknowledges that it is prepared to transmit data by pulling SDA low. Two bytes of data are then read from the device, which are both acknowledged by the master, as shown in Figure 40. A stop condition follows. If the master does not acknowledge the first byte, the second byte is not transmitted by the AD5122A/AD5142A.

The AD5122A/AD5142A do not support repeat readback.

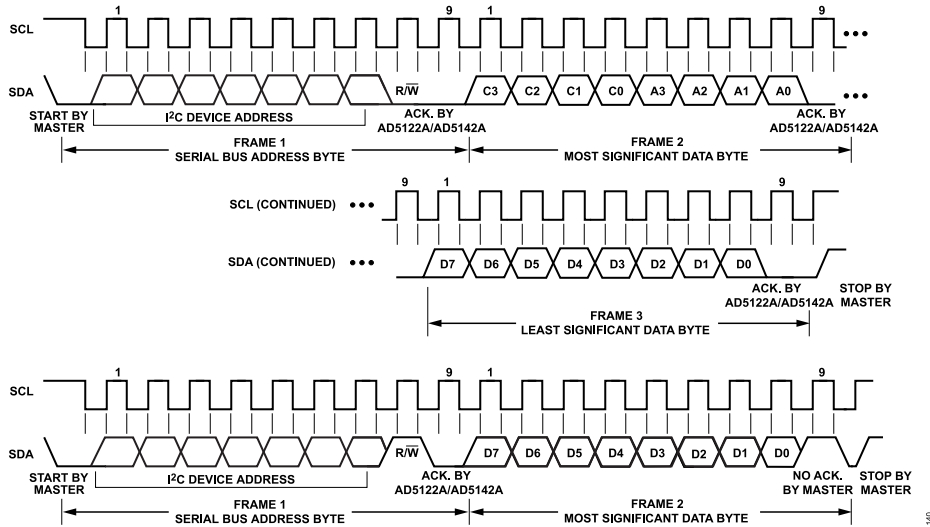

Figure 40. AD5122A/AD5142A Interface Read Command

## THEORY OF OPERATION

## ADVANCED CONTROL MODES

The AD5122A/AD5142A digital potentiometers include a set of user programming features to address the wide number of applications for these universal adjustment devices (see [Table 13](#) and [Table 15](#)).

Key programming features include the following:

► Input register

- Linear gain setting mode
- A low wiper resistance feature
- Linear increment and decrement instructions
- $\pm 6$  dB increment and decrement instructions
- Burst mode
- Reset
- Shutdown mode

**Table 13. Advanced Command Operation Truth Table**

| Command Number | Command Bits[DB15:DB12] |      |    |    | Address Bits[DB11:DB8] <sup>1</sup> |    |    |    | Data Bits[DB7:DB0] <sup>1</sup> |    |    |    |    |    |    |  | Operation   |    |                  |
|----------------|-------------------------|------|----|----|-------------------------------------|----|----|----|---------------------------------|----|----|----|----|----|----|--|---|----|------------------|
|                | C3                      | C2   | C1 | C0 | A3                                  | A2 | A1 | A0 | D7                              | D6 | D5 | D4 | D3 | D2 | D1 | D0   |   |    |                  |
| 0              | 0                       | 0    | 0  | 0  | X                                   | X  | X  | X  | X                               | X  | X  | X  | X  | X  | X  | X  | NOP: do nothing   |    |                  |
| 1              | 0                       | 0    | 0  | 1  | 0                                   | A2 | 0  | A0 | D7                              | D6 | D5 | D4 | D3 | D2 | D1 | D0   | Write contents of serial register data to RDAC                |    |                  |
| 2              | 0                       | 0    | 1  | 0  | 0                                   | A2 | 0  | A0 | D7                              | D6 | D5 | D4 | D3 | D2 | D1 | D0   | Write contents of serial register data to input register      |    |                  |
| 3              | 0                       | 0    | 1  | 1  | X                                   | A2 | A1 | A0 | X                               | X  | X  | X  | X  | X  | D1 | D0   | Read back contents  |    |                  |
|                |                         |      |    |    |                                     |    |    |    |                                 |    |    |    |    |    |    |  | D1  | D0 | Data             |
|                |                         |      |    |    |                                     |    |    |    |                                 |    |    |    |    |    |    |  | 0   | 0  | Input register   |
|                |                         |      |    |    |                                     |    |    |    |                                 |    |    |    |    |    |    |  | 0   | 1  | EEPROM           |
|                |                         |      |    |    |                                     |    |    |    |                                 |    |    |    |    |    |    |  | 1   | 0  | Control register |
| 1              | 1                       | RDAC |    |    |                                     |    |    |    |                                 |    |    |    |    |    |    |  |   |    |                  |
| 4              | 0                       | 1    | 0  | 0  | A3                                  | A2 | 0  | A0 | X                               | X  | X  | X  | X  | X  | X  | 1  | Linear RDAC increment   |    |                  |
| 5              | 0                       | 1    | 0  | 0  | A3                                  | A2 | 0  | A0 | X                               | X  | X  | X  | X  | X  | X  | 0  | Linear RDAC decrement   |    |                  |
| 6              | 0                       | 1    | 0  | 1  | A3                                  | A2 | 0  | A0 | X                               | X  | X  | X  | X  | X  | X  | 1  | +6 dB RDAC increment  |    |                  |
| 7              | 0                       | 1    | 0  | 1  | A3                                  | A2 | 0  | A0 | X                               | X  | X  | X  | X  | X  | X  | 0  | -6 dB RDAC decrement  |    |                  |
| 8              | 0                       | 1    | 1  | 0  | 0                                   | A2 | 0  | A0 | X                               | X  | X  | X  | X  | X  | X  | X  | Copy input register to RDAC (software LRDAC)                  |    |                  |
| 9              | 0                       | 1    | 1  | 1  | 0                                   | A2 | 0  | A0 | X                               | X  | X  | X  | X  | X  | X  | 1  | Copy RDAC register to EEPROM                                  |    |                  |
| 10             | 0                       | 1    | 1  | 1  | 0                                   | A2 | 0  | A0 | X                               | X  | X  | X  | X  | X  | X  | 0  | Copy EEPROM into RDAC   |    |                  |
| 11             | 1                       | 0    | 0  | 0  | 0                                   | 0  | A1 | A0 | D7                              | D6 | D5 | D4 | D3 | D2 | D1 | D0   | Write contents of serial register data to EEPROM              |    |                  |
| 12             | 1                       | 0    | 0  | 1  | A3                                  | A2 | 0  | A0 | 1                               | X  | X  | X  | X  | X  | X  | X  | Top scale   |    |                  |
|                |                         |      |    |    |                                     |    |    |    |                                 |    |    |    |    |    |    |  | D0 = 0; normal mode<br>D0 = 1; shutdown mode                  |    |                  |
| 13             | 1                       | 0    | 0  | 1  | A3                                  | A2 | 0  | A0 | 0                               | X  | X  | X  | X  | X  | X  | X  | Bottom scale  |    |                  |
|                |                         |      |    |    |                                     |    |    |    |                                 |    |    |    |    |    |    |  | D0 = 1; enter<br>D0 = 0; exit                                 |    |                  |
| 14             | 1                       | 0    | 1  | 1  | X                                   | X  | X  | X  | X                               | X  | X  | X  | X  | X  | X  | X  | Software reset  |    |                  |
| 15             | 1                       | 1    | 0  | 0  | A3                                  | A2 | 0  | A0 | X                               | X  | X  | X  | X  | X  | X  | X  | Software shutdown   |    |                  |
|                |                         |      |    |    |                                     |    |    |    |                                 |    |    |    |    |    |    |  | D0 = 0; normal mode<br>D0 = 1; device placed in shutdown mode |    |                  |
| 16             | 1                       | 1    | 0  | 1  | X                                   | X  | X  | X  | X                               | X  | X  | D3 | D2 | D1 | D0 | Copy serial register data to control register, refer to <a href="#">Table 15</a> |   |    |                  |

<sup>1</sup> X = don't care.

## THEORY OF OPERATION

Table 14. Address Bits

| A3 | A2             | A1             | A0             | Potentiometer Mode |                | Linear Gain Setting Mode |                  | Stored Channel Memory  |
|----|----------------|----------------|----------------|--------------------|----------------|--------------------------|------------------|------------------------|
|    |                |                |                | Input Register     | RDAC Register  | Input Register           | RDAC Register    |                        |
| 1  | X <sup>1</sup> | X <sup>1</sup> | X <sup>1</sup> | All channels       | All channels   | All channels             | All channels     | Not applicable         |
| 0  | 0              | 0              | 0              | RDAC1              | RDAC1          | R <sub>WB1</sub>         | R <sub>WB1</sub> | RDAC1/R <sub>WB1</sub> |
| 0  | 1              | 0              | 0              | Not applicable     | Not applicable | R <sub>AW1</sub>         | R <sub>AW1</sub> | Not applicable         |
| 0  | 0              | 0              | 1              | RDAC2              | RDAC2          | R <sub>WB2</sub>         | R <sub>WB2</sub> | R <sub>AW1</sub>       |
| 0  | 1              | 0              | 1              | Not applicable     | Not applicable | R <sub>AW2</sub>         | R <sub>AW2</sub> | Not applicable         |
| 0  | 0              | 1              | 0              | Not applicable     | Not applicable | Not applicable           | Not applicable   | RDAC2/R <sub>WB2</sub> |
| 0  | 0              | 1              | 1              | Not applicable     | Not applicable | Not applicable           | Not applicable   | R <sub>AW2</sub>       |

<sup>1</sup> X = don't care.

Table 15. Control Register Bit Descriptions

| Bit Name | Description   |
|----------|---|
| D0       | RDAC register write protect<br>0 = wiper position frozen to value in EEPROM memory<br>1 = allows update of wiper position through digital interface (default) |
| D1       | EEPROM program enable<br>0 = EEPROM program disabled<br>1 = enables device for EEPROM program (default)   |
| D2       | Linear setting mode/potentiometer mode<br>0 = potentiometer mode (default)<br>1 = linear gain setting mode  |
| D3       | Burst mode (I <sup>2</sup> C only)<br>0 = disabled (default)<br>1 = enabled (no disable after stop or repeated start condition)                               |

## THEORY OF OPERATION

### Input Register

The AD5122A/AD5142A include one input register per RDAC register. These registers allow preloading of the value for the associated RDAC register. These registers can be written to using Command 2 and read back from using Command 3 (see [Table 13](#)).

This feature allows a synchronous update of one or both RDAC registers at the same time.

The transfer from the input register to the RDAC register is done synchronously by Command 8 (see [Table 13](#)).

If new data is loaded in an RDAC register, this RDAC register automatically overwrites the associated input register.

### Linear Gain Setting Mode

The proprietary architecture of the AD5122A/AD5142A allows the independent control of each string resistor,  $R_{AW}$ , and  $R_{WB}$ . To enable linear gain setting mode, use Command 16 (see [Table 13](#)) to set Bit D2 of the control register (see [Table 15](#)).

This mode of operation can control the potentiometer as two independent rheostats connected at a single point, W terminal, as opposed to potentiometer mode where each resistor is complementary,  $R_{AW} = R_{AB} - R_{WB}$ .

This mode enables a second input and an RDAC register per channel, as shown in [Table 13](#); however, the actual RDAC contents remain unchanged. The same operations are valid for potentiometer and linear gain setting mode.

If the INDEP pin is pulled high, the device powers up in linear gain setting mode and loads the values stored in the associated memory locations for each channel (see [Table 14](#)). The INDEP pin and the D2 bit are connected internally to a logic OR gate; if one or both are set to 1, the parts cannot operate in potentiometer mode.

### Low Wiper Resistance Feature

The AD5122A/AD5142A include two commands to reduce the wiper resistance between the terminals when the device achieves full scale or zero scale. These extra positions are called bottom scale, BS, and top scale, TS. The resistance between Terminal A and Terminal W at top scale is specified as  $R_{TS}$ . Similarly, the bottom scale resistance between Terminal B and Terminal W is specified as  $R_{BS}$ .

The contents of the RDAC registers are unchanged by entering in these positions. There are three ways to exit from top scale and bottom scale: by using Command 12 or Command 13 (see [Table 13](#)); by loading new data in an RDAC register, which includes increment/decrement operations; or by entering shutdown mode, Command 15 (see [Table 13](#)).

[Table 16](#) and [Table 17](#) show the truth tables for the top scale position and the bottom scale position, respectively, when potentiometer or linear gain setting mode is enabled.

**Table 16. Top Scale Truth Table**

| Linear Gain Setting Mode |          | Potentiometer Mode |          |
|--------------------------|----------|--------------------|----------|
| $R_{AW}$                 | $R_{WB}$ | $R_{AW}$           | $R_{WB}$ |
| $R_{AB}$                 | $R_{AB}$ | $R_{TS}$           | $R_{AB}$ |

**Table 17. Bottom Scale Truth Table**

| Linear Gain Setting Mode |          | Potentiometer Mode |          |
|--------------------------|----------|--------------------|----------|
| $R_{AW}$                 | $R_{WB}$ | $R_{AW}$           | $R_{WB}$ |
| $R_{TS}$                 | $R_{BS}$ | $R_{AB}$           | $R_{BS}$ |

### Linear Increment and Decrement Instructions

The increment and decrement commands (Command 4 and Command 5 in [Table 13](#)) are useful for linear step adjustment applications. These commands simplify microcontroller software coding by allowing the controller to send an increment or decrement command to the device. The adjustment can be individual or in a ganged potentiometer arrangement, where all wiper positions are changed at the same time.

For an increment command, executing Command 4 automatically moves the wiper to the next RDAC position. This command can be executed in a single channel or in multiple channels.

### ±6 dB Increment and Decrement Instructions

Two programming instructions produce logarithmic taper increment or decrement of the wiper position control by an individual potentiometer or by a ganged potentiometer arrangement where all RDAC register positions are changed simultaneously. The +6 dB increment is activated by Command 6, and the -6 dB decrement is activated by Command 7 (see [Table 13](#)). For example, starting with the zero-scale position and executing Command 6 ten times moves the wiper in 6 dB steps to the full-scale position. When the wiper position is near the maximum setting, the last 6 dB increment instruction causes the wiper to go to the full-scale position (see [Table 18](#)).

Incrementing the wiper position by +6 dB essentially doubles the RDAC register value, whereas decrementing the wiper position by -6 dB halves the register value. Internally, the AD5122A/AD5142A use shift registers to shift the bits left and right to achieve a ±6 dB increment or decrement. These functions are useful for various audio/video level adjustments, especially for white LED brightness settings in which human visual responses are more sensitive to large adjustments than to small adjustments.

**Table 18. Detailed Left Shift and Right Shift Functions for the ±6 dB Step Increment and Decrement**

| Left Shift (+6 dB/Step) | Right Shift (-6 dB/Step) |
|-------------------------|--------------------------|
| 0000 0000               | 1111 1111                |
| 0000 0001               | 0111 1111                |
| 0000 0010               | 0011 1111                |
| 0000 0100               | 0001 1111                |
| 0000 1000               | 0000 1111                |



## THEORY OF OPERATION

**Table 18. Detailed Left Shift and Right Shift Functions for the  $\pm 6$  dB Step Increment and Decrement**

| Left Shift (+6 dB/Step) | Right Shift (-6 dB/Step) |
|-------------------------|--------------------------|
| 0001 0000               | 0000 0111                |
| 0010 0000               | 0000 0011                |
| 0100 0000               | 0000 0001                |
| 1000 0000               | 0000 0000                |
| 1111 1111               | 0000 0000                |

### Burst Mode

By enabling the burst mode, multiple data bytes can be sent to the part consecutively. After the command byte, the part interprets the following consecutive bytes as data bytes for the command.

A new command can be sent by generating a repeat start or by a stop and start condition.

The burst mode is activated by setting Bit D3 of the control register (see Table 15).

### Reset

The AD5122A/AD5142A can be reset through software by executing Command 14 (see Table 13) or through hardware on the low pulse of the  $\overline{\text{RESET}}$  pin. The reset command loads the RDAC registers with the contents of the EEPROM and takes approximately 30  $\mu\text{s}$ . The EEPROM is preloaded to midscale at the factory, and initial power-up is, accordingly, at midscale. Tie  $\overline{\text{RESET}}$  to  $V_{\text{LOGIC}}$  if the  $\overline{\text{RESET}}$  pin is not used.

### Shutdown Mode

The AD5122A/AD5142A can be placed in shutdown mode by executing the software shutdown command, Command 15 (see Table 13), and setting the LSB (D0) to 1. This feature places the RDAC in a zero power consumption state where the device operates in potentiometer mode, Terminal A is open-circuited and the wiper, Terminal W, is connected to Terminal B; however, a finite wiper resistance of 40  $\Omega$  is present. When the device is configured in linear gain setting mode, the resistor addressed,  $R_{\text{AW}}$  or  $R_{\text{WB}}$ , is internally placed at high impedance. Table 19 shows the truth table depending on the device operating mode. The contents of the RDAC register are unchanged by entering shutdown mode. However, all commands listed in Table 13 are supported while in shutdown mode. Execute Command 15 (see Table 13) and set the LSB (D0) to 0 to exit shutdown mode.

**Table 19. Truth Table for Shutdown Mode**

| Linear Gain Setting Mode |                 | Potentiometer Mode |                 |
|--------------------------|-----------------|--------------------|-----------------|
| $R_{\text{AW}}$          | $R_{\text{WB}}$ | $R_{\text{AW}}$    | $R_{\text{WB}}$ |
| High impedance           | High impedance  | High impedance     | $R_{\text{BS}}$ |

## EEPROM OR RDAC REGISTER PROTECTION

The EEPROM and RDAC registers can be protected by disabling any update to these registers. This can be done by using software. If these registers are protected by software, set Bit D0 and/or Bit D1 (see Table 15), which protects the RDAC and EEPROM registers independently.

When RDAC is protected, the only operation allowed is to copy the EEPROM into the RDAC register.

### INDEP PIN

If the INDEP pin is pulled high at power-up, the part operates in linear gain setting mode, loading each string resistor,  $R_{\text{AWX}}$  and  $R_{\text{WBX}}$ , with the value stored into the EEPROM (see Table 14). If the pin is pulled low, the part powers up in potentiometer mode.

The INDEP pin and the D2 bit are connected internally to a logic OR gate; if one or both are set to 1, the part cannot operate in potentiometer mode (see Table 15).

## RDAC ARCHITECTURE

To achieve optimum performance, Analog Devices, Inc., has proprietary RDAC segmentation architecture for all the digital potentiometers. In particular, the AD5122A/AD5142A employ a three-stage segmentation approach, as shown in Figure 41. The AD5122A/AD5142A wiper switch is designed with the transmission gate CMOS topology and with the gate voltage derived from  $V_{\text{DD}}$  and  $V_{\text{SS}}$ .

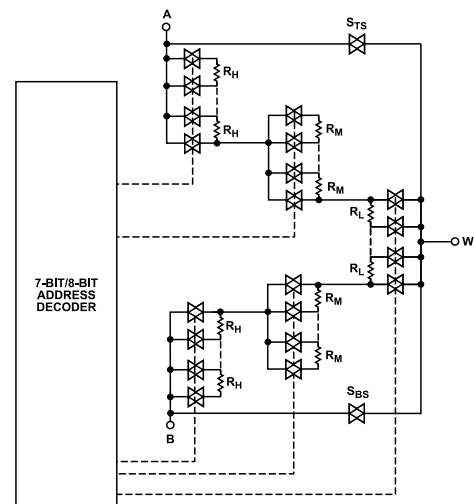

**Figure 41. AD5122A/AD5142A Simplified RDAC Circuit**

## Top Scale/Bottom Scale Architecture

In addition, the AD5122A/AD5142A include new positions to reduce the resistance between terminals. These positions are called bottom scale and top scale. At bottom scale, the typical wiper resistance decreases from 130  $\Omega$  to 60  $\Omega$  ( $R_{\text{AB}} = 100 \text{ k}\Omega$ ). At top scale, the resistance between Terminal A and Terminal W is

## THEORY OF OPERATION

decreased by 1 LSB, and the total resistance is reduced to 60  $\Omega$  ( $R_{AB} = 100 \text{ k}\Omega$ ).

### PROGRAMMING THE VARIABLE RESISTOR

#### Rheostat Operation— $\pm 8\%$ Resistor Tolerance

The AD5122A/AD5142A operate in rheostat mode when only two terminals are used as a variable resistor. The unused terminal can be floating, or it can be tied to Terminal W, as shown in Figure 42.

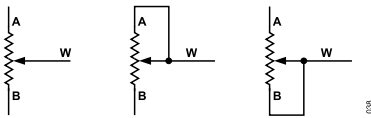

Figure 42. Rheostat Mode Configuration

The nominal resistance between Terminal A and Terminal B,  $R_{AB}$ , is 10 k $\Omega$  or 100 k $\Omega$ , and has 128/256 tap points accessed by the wiper terminal. The 7-bit/8-bit data in the RDAC latch is decoded to select one of the 128/256 possible wiper settings. The general equations for determining the digitally programmed output resistance between Terminal W and Terminal B are

AD5122A:

$$R_{WB}(D) = \frac{D}{128} \times R_{AB} + R_W \quad \text{From } 0x00 \text{ to } 0x7F \quad (1)$$

AD5142A:

$$R_{WB}(D) = \frac{D}{256} \times R_{AB} + R_W \quad \text{From } 0x00 \text{ to } 0xFF \quad (2)$$

where:

$D$  is the decimal equivalent of the binary code in the 7-bit/8-bit RDAC register.

$R_{AB}$  is the end-to-end resistance.

$R_W$  is the wiper resistance.

In potentiometer mode, similar to the mechanical potentiometer, the resistance between Terminal W and Terminal A also produces a digitally controlled complementary resistance,  $R_{WA}$ .  $R_{WA}$  also gives a maximum of 8% absolute resistance error.  $R_{WA}$  starts at the maximum resistance value and decreases as the data loaded into the latch increases. The general equations for this operation are

AD5122A:

$$R_{AW}(D) = \frac{128-D}{128} \times R_{AB} + R_W \quad \text{From } 0x00 \text{ to } 0x7F \quad (3)$$

AD5142A:

$$R_{AW}(D) = \frac{256-D}{256} \times R_{AB} + R_W \quad \text{From } 0x00 \text{ to } 0xFF \quad (4)$$

where:

$D$  is the decimal equivalent of the binary code in the 7-bit/8-bit RDAC register.

$R_{AB}$  is the end-to-end resistance.

$R_W$  is the wiper resistance.

If the part is configured in linear gain setting mode, the resistance between Terminal W and Terminal A is directly proportional to the code loaded in the associate RDAC register. The general equations for this operation are

AD5122A:

$$R_{AW}(D) = \frac{D}{128} \times R_{AB} + R_W \quad \text{From } 0x00 \text{ to } 0x7F \quad (5)$$

AD5142A:

$$R_{AW}(D) = \frac{D}{256} \times R_{AB} + R_W \quad \text{From } 0x00 \text{ to } 0xFF \quad (6)$$

where:

$D$  is the decimal equivalent of the binary code in the 7-bit/8-bit RDAC register.

$R_{AB}$  is the end-to-end resistance.

$R_W$  is the wiper resistance.

In the bottom scale condition or top scale condition, a finite total wiper resistance of 40  $\Omega$  is present. Regardless of which setting the part is operating in, limit the current between Terminal A to Terminal B, Terminal W to Terminal A, and Terminal W to Terminal B, to the maximum continuous current or to the pulse current specified in Table 5. Otherwise, degradation or possible destruction of the internal switch contact can occur.

### PROGRAMMING THE POTENTIOMETER DIVIDER

#### Voltage Output Operation

The digital potentiometer easily generates a voltage divider at wiper-to-B and wiper-to-A that is proportional to the input voltage at A to B, as shown in Figure 43.

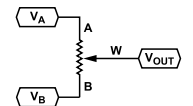

Figure 43. Potentiometer Mode Configuration

Connecting Terminal A to 5 V and Terminal B to ground produces an output voltage at the Wiper W to Terminal B ranging from 0 V to 5 V. The general equation defining the output voltage at  $V_W$  with respect to ground for any valid input voltage applied to Terminal A and Terminal B is

$$V_W(D) = \frac{R_{WB}(D)}{R_{AB}} \times V_A + \frac{R_{AW}(D)}{R_{AB}} \times V_B \quad (7)$$

where:

$R_{WB}(D)$  can be obtained from Equation 1 and Equation 2.

$R_{AW}(D)$  can be obtained from Equation 3 and Equation 4.

Operation of the digital potentiometer in the divider mode results in a more accurate operation over temperature. Unlike the rheostat mode, the output voltage is dependent mainly on the ratio of the

## THEORY OF OPERATION

internal resistors,  $R_{AW}$  and  $R_{WB}$ , and not the absolute values. Therefore, the temperature drift reduces to 5 ppm/°C.

### TERMINAL VOLTAGE OPERATING RANGE

The AD5122A/AD5142A are designed with internal ESD diodes for protection. These diodes also set the voltage boundary of the terminal operating voltages. Positive signals present on Terminal A, Terminal B, or Terminal W that exceed  $V_{DD}$  are clamped by the forward-biased diode. There is no polarity constraint between  $V_A$ ,  $V_W$ , and  $V_B$ , but they cannot be higher than  $V_{DD}$  or lower than  $V_{SS}$ .

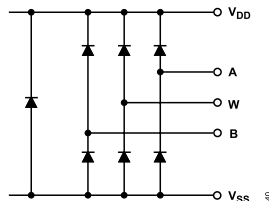

Figure 44. Maximum Terminal Voltages Set by  $V_{DD}$  and  $V_{SS}$

### POWER-UP SEQUENCE

Because there are diodes to limit the voltage compliance at Terminal A, Terminal B, and Terminal W (see Figure 44), it is important to power up  $V_{DD}$  first before applying any voltage to Terminal A, Terminal B, and Terminal W. Otherwise, the diode is forward-biased such that  $V_{DD}$  is powered unintentionally. The ideal power-up sequence is  $V_{SS}$ ,  $V_{DD}$ ,  $V_{LOGIC}$ , digital inputs, and  $V_A$ ,  $V_B$ , and  $V_W$ . The order of powering  $V_A$ ,  $V_B$ ,  $V_W$ , and digital inputs is not important as long as they are powered after  $V_{SS}$ ,  $V_{DD}$ , and  $V_{LOGIC}$ . Regardless of the power-up sequence and the ramp rates of the power supplies, once  $V_{DD}$  is powered, the power-on preset activates, which restores EEPROM values to the RDAC registers.

### LAYOUT AND POWER SUPPLY BIASING

It is always a good practice to use a compact, minimum lead length layout design. Ensure that the leads to the input are as direct as possible with a minimum conductor length. Ground paths should have low resistance and low inductance. It is also good practice to bypass the power supplies with quality capacitors. Apply low equivalent series resistance (ESR) 1  $\mu$ F to 10  $\mu$ F tantalum or electrolytic capacitors at the supplies to minimize any transient disturbance and to filter low frequency ripple. Figure 45 illustrates the basic supply bypassing configuration for the AD5122A/AD5142A.

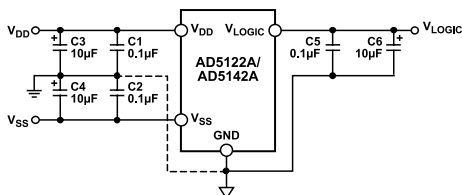
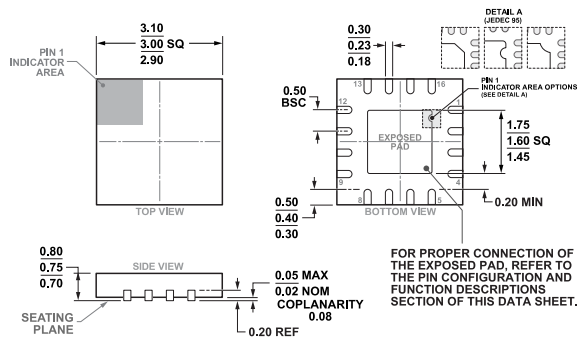

Figure 45. Power Supply Bypassing

OUTLINE DIMENSIONS



COMPLIANT TO JEDEC STANDARDS MO-220-WEED-6

**Figure 46. 16-Lead Lead Frame Chip Scale Package [LFCSP]  
3 mm x 3 mm Body and 0.75 mm Package Height  
(CP-16-22)  
Dimensions shown in millimeters**

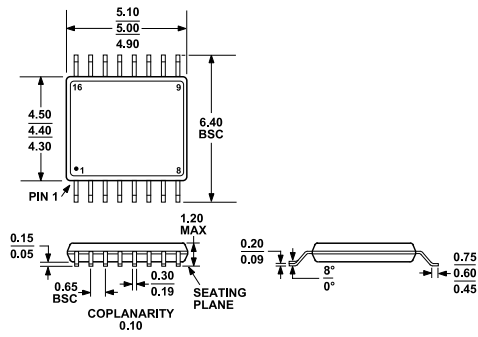

COMPLIANT TO JEDEC STANDARDS MO-153-AB

**Figure 47. 16-Lead Thin Shrink Small Outline Package [TSSOP]  
(RU-16)  
Dimensions shown in millimeters**

## OUTLINE DIMENSIONS

Updated: March 08, 2022

## ORDERING GUIDE

| Model <sup>1, 2</sup> | Temperature Range | Package Description             | Packing Quantity | Package Option | Marking Code |
|-----------------------|-------------------|---------------------------------|------------------|----------------|--------------|
| AD5122ABCPZ100-RL7    | -40°C to +125°C   | 16-Lead LFCSP (3mm x 3mm w/ EP) | Reel, 1500       | CP-16-22       | DHG          |
| AD5122ABCPZ10-RL7     | -40°C to +125°C   | 16-Lead LFCSP (3mm x 3mm w/ EP) | Reel, 1500       | CP-16-22       | DHA          |
| AD5122ABRUZ10         | -40°C to +125°C   | 16-Lead TSSOP                   | Tube, 96         | RU-16          |              |
| AD5122ABRUZ100        | -40°C to +125°C   | 16-Lead TSSOP                   | Tube, 96         | RU-16          |              |
| AD5122ABRUZ100-RL7    | -40°C to +125°C   | 16-Lead TSSOP                   | Reel, 1000       | RU-16          |              |
| AD5122ABRUZ10-RL7     | -40°C to +125°C   | 16-Lead TSSOP                   | Reel, 1000       | RU-16          |              |
| AD5122AWBCPZ10-RL7    | -40°C to +125°C   | 16-Lead LFCSP (3mm x 3mm w/ EP) | Reel, 1500       | CP-16-22       | DN1          |
| AD5142ABCPZ100-RL7    | -40°C to +125°C   | 16-Lead LFCSP (3mm x 3mm w/ EP) | Reel, 1500       | CP-16-22       | DH4          |
| AD5142ABCPZ10-RL7     | -40°C to +125°C   | 16-Lead LFCSP (3mm x 3mm w/ EP) | Reel, 1500       | CP-16-22       | DH7          |
| AD5142ABRUZ10         | -40°C to +125°C   | 16-Lead TSSOP                   | Tube, 96         | RU-16          |              |
| AD5142ABRUZ100        | -40°C to +125°C   | 16-Lead TSSOP                   | Tube, 96         | RU-16          |              |
| AD5142ABRUZ100-RL7    | -40°C to +125°C   | 16-Lead TSSOP                   | Reel, 1000       | RU-16          |              |
| AD5142ABRUZ10-RL7     | -40°C to +125°C   | 16-Lead TSSOP                   | Reel, 1000       | RU-16          |              |
| AD5142AWBCPZ10-RL7    | -40°C to +125°C   | 16-Lead LFCSP (3mm x 3mm w/ EP) | Reel, 1500       | CP-16-22       | DMZ          |

<sup>1</sup> Z = RoHS Compliant Part.<sup>2</sup> W = Qualified for Automotive Applications.R<sub>AB</sub> (KΩ), RESOLUTION, AND INTERFACE OPTIONS

| Model <sup>1, 2</sup> | R <sub>AB</sub> (kΩ) | Resolution | Interface        |
|-----------------------|----------------------|------------|------------------|
| AD5122ABCPZ10-RL7     | 10                   | 128        | I <sup>2</sup> C |
| AD5122ABCPZ100-RL7    | 100                  | 128        | I <sup>2</sup> C |
| AD5122AWBCPZ10-RL7    | 10                   | 128        | I <sup>2</sup> C |
| AD5122ABRUZ10         | 10                   | 128        | I <sup>2</sup> C |
| AD5122ABRUZ100        | 100                  | 128        | I <sup>2</sup> C |
| AD5122ABRUZ10-RL7     | 10                   | 128        | I <sup>2</sup> C |
| AD5122ABRUZ100-RL7    | 100                  | 128        | I <sup>2</sup> C |
| AD5142ABCPZ10-RL7     | 10                   | 256        | I <sup>2</sup> C |
| AD5142ABCPZ100-RL7    | 100                  | 256        | I <sup>2</sup> C |
| AD5142AWBCPZ10-RL7    | 10                   | 256        | I <sup>2</sup> C |
| AD5142ABRUZ10         | 10                   | 256        | I <sup>2</sup> C |
| AD5142ABRUZ100        | 100                  | 256        | I <sup>2</sup> C |
| AD5142ABRUZ10-RL7     | 10                   | 256        | I <sup>2</sup> C |
| AD5142ABRUZ100-RL7    | 100                  | 256        | I <sup>2</sup> C |

<sup>1</sup> Z = RoHS Compliant Part.<sup>2</sup> W = Qualified for Automotive Applications.

## EVALUATION BOARDS

| Model <sup>1, 2</sup> | Description      |
|-----------------------|------------------|
| EVAL-AD5142ADBZ       | Evaluation Board |

<sup>1</sup> Z = RoHS Compliant Part.<sup>2</sup> The evaluation board is shipped with the 10 kΩ RAB resistor option; however, the board is compatible with both of the available resistor value options.