

FEATURES

- High instantaneous dynamic range
 - Noise figure (NF) as low as 13 dB
 - Noise spectral density (NSD) as low as -159 dBFS/Hz
 - IIP3 up to 36.9 dBm with spurious tones <-99 dBFS
- Tunable band-pass Σ - Δ analog-to-digital converter (ADC)
 - 20 MHz to 160 MHz signal bandwidth
 - 70 MHz to 450 MHz IF center frequency
 - Configurable input full-scale level of -2 dBm to -14 dBm
 - Easy to drive resistive IF input
 - Gain flatness of 1 dB with under 0.5 dB out-of-band peaking
 - Alias rejection greater than 50 dB
- 2.0 GSPS to 3.2 GSPS ADC clock rate
 - On-chip PLL clock multiplier
- 16-bit I/Q rate up to 266 MSPS
- On-chip digital signal processing
 - NCO and quadrature digital downconverter (QDDC)
 - Selectable decimation factor of 12, 16, 24, and 32
- Automatic gain control (AGC) support
 - On-chip attenuator with 27 dB span in 1 dB steps
 - Fast attenuator control via configurable AGC data port
 - Peak detection flags with programmable thresholds
- Single or dual lane, JESD204B capable
- Low power consumption: 1.20 W
 - 1.1 V and 2.5 V supply voltage
 - TDD power saving up to 60%
- 4.3 mm \times 5.0 mm WLCSP

APPLICATIONS

- Wideband cellular infrastructure equipment and repeaters
- Point-to-point microwave equipment
- Instrumentation
 - Spectrum and communication analyzers
- Software defined radio

GENERAL DESCRIPTION

The AD6676¹ is a highly integrated IF subsystem that can digitize radio frequency (RF) bands up to 160 MHz in width centered on an intermediate frequency (IF) of 70 MHz to 450 MHz. Unlike traditional Nyquist IF sampling ADCs, the AD6676 relies on a tunable band-pass Σ - Δ ADC with a high oversampling ratio to eliminate the need for band specific IF SAW filters and gain stages, resulting in significant simplification of the wideband radio receiver architecture. On-chip quadrature digital downconversion followed by selectable decimation filters reduces the complex data rate to a manageable rate between 62.5 MSPS to 266.7 MSPS. The 16-bit complex output data is transferred to the host via a single or dual lane JESD204B interface supporting line rates of up to 5.333 Gbps.

FUNCTIONAL BLOCK DIAGRAM

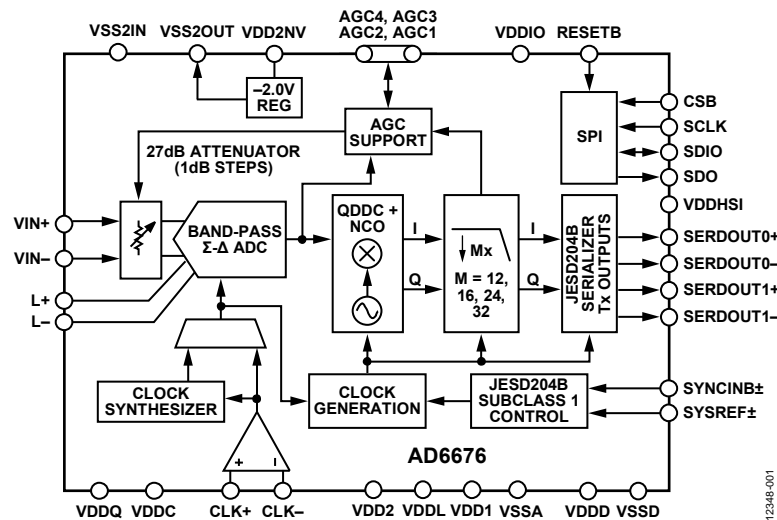

Figure 1.

¹ This product is protected by U.S. and international patents.

TABLE OF CONTENTS

Features	1	Attenuator.....	33
Applications.....	1	Clock Synthesizer	35
General Description	1	Digital Processing Blocks	38
Functional Block Diagram	1	Digital Signal Processing Path.....	39
Revision History	3	AGC Features and Peak Detection.....	42
Product Highlights	4	GPIO Functionality.....	44
Specifications.....	5	Power Saving Modes	44
Digital High Speed SERDES Specifications	7	Introduction to the JESD204B Interface	45
CLK± to SYSREF± Timing Diagram	8	Functional Overview	47
Digital CMOS Input/Output Specifications	8	JESD204B Link Establishment	47
Absolute Maximum Ratings.....	9	Physical Layer Input/Outputs.....	49
Thermal Resistance	9	Configuring the JESD204B Link.....	50
ESD Caution.....	9	Synchronization Using SYSREF±.....	51
Pin Configuration and Function Descriptions.....	10	Applications Information.....	53
Typical Performance Characteristics	12	Analog Input Considerations	53
Nominal Performance for IF = 115 MHz (Direct Sampling VHF Receiver)	12	Clock Input Considerations.....	54
Nominal Performance for IF = 140 MHz (µW Point-to-Point Receivers).....	14	IF Frequency Planning	56
Nominal Performance for IF = 181 MHz (Wireless Infrastructure Receiver).....	15	PCB Design Guidelines	57
Nominal Performance for IF = 250 MHz AND BW = 75 MHz	17	Powering the AD6676.....	59
Nominal Performance for IF = 350 MHz AND BW = 160 MHz	19	AD6676 Start-Up Initialization.....	61
Equivalent Circuits	21	Serial Port Interface (SPI).....	64
Terminology	22	SPI Register Map Description	64
Theory of Operation	23	SPI Operation	64
Overview.....	23	Register Memory Map and Details	66
Band-Pass Σ-Δ ADC Architecture	24	Register Memory Map	66
Σ-Δ ADC Configuration Considerations.....	28	Register Details.....	68
		Outline Dimensions	90
		Ordering Guide	90

REVISION HISTORY**5/2017—Rev. C to Rev. D**

Change to Differential Output Voltage Parameter, Table 2	7
Changes to Figure 147	65

3/2017—Rev. B to Rev. C

Added Endnote 1, Table 12	36
Changes to Synchronization Using SYSREF ± Section	51
Added Table 123; Renumbered Sequentially.....	87

4/2016—Rev. A to Rev. B

Changes to Figure 3 and Table 6	10
Changes to Clock Input Considerations Section and Figure 133	55

9/2015—Rev. 0 to Rev. A

Changes to Product Highlights Section	4
Changes to Clock Synthesizer Enabled Parameter, Table 1 and Out-of-Range Recovery Time Parameter Unit, Table 1	5
Changes to Differential Output Voltage, Table 2	7
Changes to Table 3	8
Changes to Figure 3.....	10
Changes to Figure 4, Figure 8 Caption, and Figure 9.....	12
Changes to Figure 26	15
Changes to Figure 36 and Figure 38	17
Changes to Figure 40, Figure 41, and Figure 44.....	18
Changes to Figure 50	19
Changes to Attenuator Section.....	33
Changes to Table 12	36
Changes to Phase Noise Performance Section, Figure 101, and Figure 102.....	37
Changes to Quadrature Digital Downconversion Section	39

Changes to Synchronization Using SYSREF± Section.....	51
Added Figure 127; Renumbered Sequentially.....	52
Changes to Input Driver Filter Considerations Section and Figure 130.....	54
Changes to Clock Input Considerations Section and Figure 133 to Figure 135	55
Changes to PCB Design Guidelines Section	57
Added Figure 141; Renumbered Sequentially.....	58
Changes to Power the AD6676 Section and Figure 142	59
Changes to AD6676 Start-Up Initialization Section and Table 25.....	61
Changes to Table 26	62
Changes to Table 27 and Table 29.....	63
Changes to Table 32	66
Changes to Coarse NCO Tuning Register Section and Table 57.....	72
Changes to Fine NCO Tuning Register Section and Table 58 ..	73
Changes to Table 70 to Table 72	75
Changes to Table 73	76
Changes to Table 109.....	84
Added Physical Control 1 Register Section and Table 116.....	85
Changes to Table 120	86
Changes to Table 121 and Table 123, and Table 125	87
Changes to CLKSYN Reference Divider and SYSREF Control Register Section, Table 128, CLKSYN Status Register Section, and Table 129	88
JESDSYN Status Register Section, Table 130, and Table 131 to Table 133.....	89

10/2014—Revision 0: Initial Version

The band-pass Σ - Δ ADC of the [AD6676](#), which operates between 2.0 GHz to 3.2 GHz, provides exceptional instantaneous dynamic range and inherent antialiasing capability. Its in-band frequency response typically maintains better than 1 dB pass band flatness with out-of-band peaking better than 0.5 dB. An integrated digital peak detector enables the instantaneous signal power to be monitored over a wide band (shortly after digitization), thus providing AGC capability to cope quickly with large in-band or out-of-band blockers.

The [AD6676](#) includes various AGC monitoring and control features along with an internal 27 dB step attenuator in 1 dB steps. A flexible AGC port with digital input/output pins allows fast control of the [AD6676](#) on-chip step attenuator and/or updates on the input signal via status flags. These features, along with the high instantaneous dynamic range, can significantly simplify AGC implementation compared to traditional narrow-band IF approaches that often require separate AGC capability for RF and IF protection.

In addition to reducing system complexity, the [AD6676](#) enables significant space and power consumption savings for next generation multiple input/multiple output (MIMO) receiver architectures. The [AD6676](#) is available in an 8×10 ball array WLCSP package that is approximately $4.3 \text{ mm} \times 5.0 \text{ mm}$, with a JESD204B serial interface that allows simple interfacing to the host processor.

Its low power consumption of 1.2 W compares favorably to IF sampling ADCs with similar bandwidth (BW) and dynamic range capabilities even without considering the added power savings from the elimination of an entire IF strip. The [AD6676](#) features multichip synchronization that allows synchronization to within a fraction of an output data sample. For time-domain duplex (TDD) applications, the [AD6676](#) features a fast power-up/power-down mode that further reduces power consumption while still maintaining multichip synchronization. Power savings of up to 60% or 42% is achievable with recovery times of $11.5 \mu\text{s}$ or $2.5 \mu\text{s}$, depending on the device configuration.

Auxiliary blocks include an on-chip PLL clock multiplier to generate the Σ - Δ ADC clock. For applications that require better phase noise performance, an external differential RF clock source may also be used. The SPI port programs numerous parameters of the [AD6676](#), allowing the device to be optimized for a variety of applications.

The [AD6676](#) is available in an 80-ball WLCSP package with an optimized pinout that enables low cost printed circuit board (PCB) manufacturing. The device operates from a 1.1 V and 2.5 V supply with a total typical power consumption of 1.2 W at 3.2 GSPS operation. This product is protected by several United States patents. Contact Analog Devices, Inc., for further information.

PRODUCT HIGHLIGHTS

1. Industry leading dynamic range enables high performance, reconfigurable heterodyne (or direct sampling VHF) software defined radios with high AGC-free range.
2. Continuous time, band-pass Σ - Δ ADC supports IFs from 70 MHz to 450 MHz with IF signal bandwidths of up to 160 MHz and reduces IF filtering requirements.
3. The high instantaneous dynamic range and oversampling nature of the Σ - Δ ADC significantly reduces the IF filter complexity.
4. On-chip 27 dB digital attenuator with easy to drive resistive input simplifies interface to RF/IF components.
5. Small $4.3 \text{ mm} \times 5.0 \text{ mm}$ package, simple interface, and integrated digital attenuator and clock synthesizer save PCB space.
6. Low input full-scale level of -2 dBm (or less) enables 3.3 V RF/IF component lineups at reduced P1dB and power.
7. Fast power saving mode supports TDD protocols.
8. Unique profile mode allows the [AD6676](#) to switch between up to four different ADC IF/BW configurations in $1 \mu\text{s}$.

SPECIFICATIONS

VDD1 = VDDL = VDDC = VDDQ = 1.1 V, VDDD = VDDHSI = 1.1 V, VDD2 = 2.5 V, VDDIO = 1.8 V, F_{IF} = 250 MHz, BW = 75 MHz, F_{ADC} = 3.2 GHz, attenuator = 0 dB, L_{\pm} (inductor values) = 19 nH, maximum PIN_0dBFS setting with $IDAC1_{FS}$ = 4 mA, $f_{DATA_{IQ}}$ = 200 MSPS, shuffler enabled (every clock cycle) with default threshold of 5, unless otherwise noted.

Table 1.

Parameter	Temperature	Test Conditions/Comments	Min	Typ	Max	Unit
SYSTEM DYNAMIC PERFORMANCE						
Full-Scale Input Power Level (PIN_0dBFS) ¹				-2		dBm
Maximum Continuous Wave (CW) Input Power ²			-2	-1		dBFS
Noise Figure (NF)		No signal and measured		17		dB
Worst In-Band Noise Spectral Density	Full	Over a 5 MHz bandwidth		-155	-152.5	dBFS/Hz
Noise Figure at IF Center (NF)		No signal and measured		13		dB
In-Band Noise Spectral Density (NSD)		Over a 5 MHz bandwidth		-159		dBFS/Hz
Input Second-Order Intercept (IIP2)		-6 dBFS tones		60		dBm
Second-Order Intermodulation Distortion (IMD) (IMD2)		See Table 20		-68.3		dBc
Input Third-Order Intercept (IIP3)	Full	-8 dBFS tones		36.9		dBm
Third-Order IMD (IMD3)	Full	-8 dBFS tones		-95	-84.2	dBc
Worst In-Band Spur for Swept CW Tone	Full	-2 dBFS tone		-99	-93.5	dBFS
		-10 dBFS tone		-109.6		dBFS
In-Band Noise	Full	-2 dBFS tone		-75.5	-73.7	dBFS
	Full	No CW tone		-78.5	-76.5	dBFS
Gain Variation	Full			0.5		dB
IF INPUT (VIN±)						
Input Span		0 dBFS				
0 dB Attenuator Setting				0.48		V p-p
12 dB Attenuator Setting				1.92		V p-p
Common-Mode Input Voltage		Self biased		1.0		V
Differential Input Impedance	25°C			60 2		Ω pF
Common-Mode Input Impedance	25°C			3.5		kΩ
Full-Scale Input Power Adjustment (PIN_0dBFS)		IDAC1 _{FS} span of 1 mA to 4 mA		12		dB
DIGITAL STEP ATTENUATOR (VIN±)						
Attenuation Range	Full			27		dB
Step Size	Full			1		dB
Input Return Loss	Full			20		dB
Input Return Loss Variation vs. Attenuator Setting	Full			2		dB
CLOCK INPUT (CLK±)						
Clock Synthesizer Disabled						
Frequency Range	Full		2.0		3.2	GHz
Amplitude Range	Full		0.4	0.8	2.0	V p-p
Differential Input Impedance	25°C	At 3 GHz		86 0.3		Ω pF
Common Mode Impedance	25°C	At 3 GHz		700 0.8		Ω pF
Input Return Loss	25°C	With 1:2 balun		15		dB
Common-Mode Voltage	25°C	Self biased		0.70		V
Clock Synthesizer Enabled						
Frequency Range ³	Full		10		320	MHz
Amplitude Range	Full	Single-ended into CLK+	0.4	0.8	1.1	V p-p
CLK+ Input Impedance	25°C			1.4 1.0		kΩ pF
Minimum Slew Rate				12		V/μs
Common-Mode Voltage	25°C	Self biased		0.55		V

Parameter	Temperature	Test Conditions/Comments	Min	Typ	Max	Unit
CLOCK SYNTHESIZER						
Phase Detector Frequency	Full		10		80	MHz
Minimum Charge Pump Output Current	Full			0.1		mA
Maximum Charge Pump Output Current	Full			6.4		mA
VCO Tuning Range	Full		2.94		3.2	GHz
Σ-Δ ADC AND DIGITAL DOWNCONVERTER						
Resolution	Full			16		Bits
Clock Frequency (F_{ADC})	Full		2.0		3.2	GHz
IF Center Frequency (F_{IF})	Full		70		450	MHz
IF Bandwidth		Maximum BW applies to higher F_{IF}	0.005 $\times F_{ADC}$		0.05 \times F_{ADC}	
IF Pass Band Gain Flatness	Full	F_{ADC} , F_{IF} , and BW dependent		1.0		dB
Out-of-Band Peaking		Depends on F_{ADC} , F_{IF} , and BW		0.5		dB
Alias Rejection		Regions of $F_{ADC} \pm F_{IF}$		51		dB
Fixed Decimation Factors	Full			12, 16, 24, 32		
NCO Tuning Resolution		Decimate by 12 or 24 Decimate by 16 or 32		$F_{ADC}/3072$ $F_{ADC}/4096$		
Out-of-Range Recovery Time	Full	Relative to ADC clock cycles		52		1/ F_{ADC}
POWER SUPPLY AND CONSUMPTION						
Analog Supply Voltage						
VDD1, VDDL, VDDQ, VDDC	Full		1.0725	1.1	1.1275	V
VDD2, VDD2NV	Full		2.4375	2.5	2.5625	V
VSS2IN		Use on-chip regulator, tie to VSS2OUT		-2.0		V
Digital Supply Voltage (VDDD)						
JESD204B Supply Voltage (VDDHSI)	Full		1.0725	1.1	1.1275	V
SPI Interface Supply Voltage (VDDIO)	Full		1.7	1.8	2.5625	V
Analog Supply Current						
$I_{VDD1} + I_{VDDL}$	Full			368	397	mA
$I_{VDDC} + I_{VDDQ}$	Full	CLK synthesizer disabled		57	68	mA
$I_{VDDC^4} + I_{VDDQ}$	Full	CLK synthesizer enabled		93	106	mA
$I_{VDD2} + I_{VDD2NV}$	Full			145	165	mA
Digital Supply Current (I_{VDDD})						
JESD204B Supply Current (I_{VDDHSI})	Full			141	208	mA
SPI Interface Supply Current (I_{VDDIO})	Full			164	190	mA
Power Consumption						
With CLK SYN Disabled				1.16	1.31	W
With CLK SYN Enabled				1.20	1.34	W
Standby ⁵	Full			0.44		W
Power-Down	Full			66	177	mW
OPERATING TEMPERATURE RANGE			-40		+85	°C

¹ Extrapolated input power level is measured at the center of IF pass band that results in a 0 dBFS power level.

² The overload level of the Σ - Δ ADC for a CW tone is guaranteed up to -2 dBFS back off from full scale but typically exceeds -1 dBFS. Input signals that have a higher peak-to-average ratio (PAR) than a CW tone (PAR = 3 dB) must apply additional back off based on the difference in PAR.

³ The clock synthesizer reference divider (Register 0x2BB, Bits[7:6]) must be set to divide by 4 or by 2 to ensure that its phase detector frequency remains ≤ 40 MHz.

⁴ $f_{CLK} = 200$ MHz, $F_{ADC} = 3.2$ GHz.

⁵ The AD6676 is configured for recovery time of 11.5 μ s with VSS2 generator/ digital data in standby (Register 0x150 = 0x40) and low power ADC state (Register 0x250 = 0x95).

DIGITAL HIGH SPEED SERDES SPECIFICATIONS

VDD1 = VDDL = VDDC = VDDQ = 1.1 V, VDDD = VDDHSI = 1.1 V, VDD2 = 2.5 V, VDDIO = 1.8 V, unless otherwise noted.

Table 2.

Parameter	Symbol	Temp.	Min	Typ	Max	Unit
HIGH SPEED SERIAL INPUT/OUTPUT						
Line Rate			1.6668		5.333	Gbps
Dual Lane Data Output Period or Unit Interval	UI	Full		$1/(20 \times f_{\text{DATA_IQ}})^1$		sec
Single Lane Data Output Period or Unit Interval	UI	Full		$1/(40 \times f_{\text{DATA_IQ}})^1$		sec
Data Output Duty Cycle		25°C		50		%
Data Valid Time		25°C		0.78		UI
PLL Lock Time		25°C		4		µs
Wake-Up Time (Standby)		25°C		5		µs
Wake-Up Time (Power-Down)		25°C		2.5		ms
Pipeline Delay (Latency)		Full		32.3		$1/f_{\text{DATA_IQ}}^1$
Deterministic Jitter		25°C		9		ps
Random Jitter at 5.333 Gbps		25°C		0.7		ps rms
Output Rise/Fall Time		25°C		45		ps
SYNCINB± Falling Edge to First K.28 Characters		25°C	4			Multiframes
CGS Phase K.28 Characters Duration		25°C	1			Multiframes
DIGITAL OUTPUTS (SERDOUT0±, SERDOUT1±)						
Logic Compliance		Full		CML		
Differential Output Voltage	VOD	Full	360		750	mV p-p
Output Offset Voltage, ANSI Mode	VOS	Full	0.75	VDDHSI/2	1.05	V
Differential Termination Impedance		25°C		100		Ω
SYSREF INPUT (SYSREF±)						
Logic Compliance				LVDS/PECL		
Differential Input Voltage		Full	0.6	1.2	1.8	V p-p
Differential Input Impedance ²		25°C		35/2		kΩ pF
Input Common-Mode Voltage			0.8	0.85	2.0	V
SYNCIN INPUT (SYNCINB+, SYNCINB-)						
Logic Compliance ³				CMOS/LVDS		
CMOS Input Voltage High	V _{IH}			$0.65 \times V_{\text{DDIO}}$		V
CMOS Input Voltage Low	V _{IL}			$0.35 \times V_{\text{DDIO}}$		V
LVDS Differential Input Voltage		Full	0.6	1.2	1.8	V p-p
LVDS Differential Input Impedance		25°C		100 1		Ω pF
LVDS Input Common-Mode Voltage			0.8	0.85	2.0	V
LVDS Input Common-Mode Impedance		25°C		1 1		kΩ pF
SYSREF (SYSREF±) TIMING REQUIREMENTS⁴						
Clock Synthesizer Disabled						
Setup Time	t _{SU_SR}	25°C		0.16		ns
Hold Time	t _{H_SR}	25°C		0.84		ns
Clock Synthesizer Enabled						
Setup Time	t _{SU_SR}	25°C		0.5		ns
Hold Time	t _{H_SR}	25°C		0.5		ns

¹ F_{DATA_IQ} corresponds to the complex output data rate (that is, F_{ADC}/DEC_FACTOR). Latency specification also includes ADC and digital filters delays. See Table 15

² The SYSREF± input requires an external differential resistor for proper termination.

³ Set via Register 0x1E7, Bit 2, with CMOS being the default setting.

⁴ SYSREF± setup and hold times are defined with respect to the rising SYSREF± edge and rising clock edge. Positive setup time leads the clock edge. Positive hold time also lags the clock rising edge. Note that the hold time takes into consideration that the internal clock signal used to sample SYSREF operates at F_{ADC}/2; thus, SYSREF± must remain high for at least two F_{ADC} clock cycles.

CLK± TO SYSREF± TIMING DIAGRAM

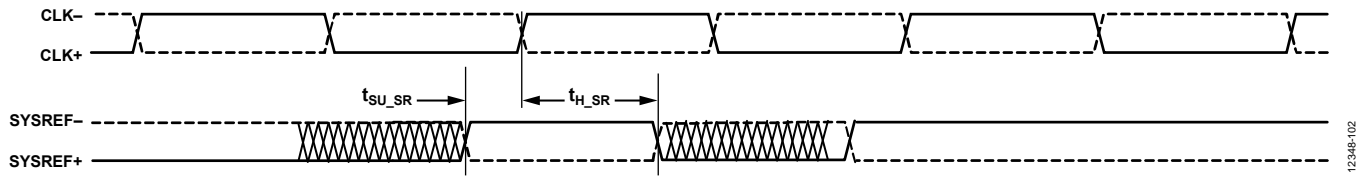

Figure 2. SERDES CLK+ to SYSREF+ Timing

12348-102

DIGITAL CMOS INPUT/OUTPUT SPECIFICATIONS

VDD1 = VDDL = VDDC = VDDQ = VDDD = VDDHSI = 1.1 V, VDD2 = 2.5 V, VDDIO = 1.8 V, unless otherwise noted.

Table 3.

Parameter	Symbol	Test Conditions/Comments	Min	Typ	Max	Unit
CMOS INPUT/OUTPUT LEVELS						
Input Voltage High	V_{IH}		$VDDIO \times 0.65$			V
Input Voltage Low	V_{IL}				$VDDIO \times 0.35$	V
Output Voltage High	V_{OH}					V
SDIO/SDO		$I_{OH} = 3 \text{ mA}$	$VDDIO \times 0.7$			V
AGCx		$I_{OH} = 0.5 \text{ mA}$	$VDDIO \times 0.7$			V
Output Voltage Low	V_{OL}					V
SDIO/SDO		$I_{OL} = 3 \text{ mA}$			0.4	V
AGCx	V_{OL}	$I_{OL} = 0.5 \text{ mA}$			0.4	V
Input Capacitance				1		pF
SPI TIMING						
SCLK Frequency	f_{SCLK}	See Figure 148, Figure 149, and Figure 150			25	MHz
SCLK Period	t_{SCLK}		40			ns
SCLK Pulse Width High	t_{HIGH}		10			ns
SCLK Pulse Width Low	t_{LOW}		10			ns
SDIO Setup Time	t_{DS}		2			ns
SDIO Hold Time	t_{DH}		2			ns
SPI_RESET Setup Time ¹	t_{SPL_RST}	Not shown in Figure 148 to Figure 150		2		ms
SCLK Falling Edge to SDO Valid Propagation Delay	t_{ACCESS}		10			ns
CSB Rising Edge to SDIO High-Z	t_Z		10			ns
CSB Fall to SCLK Rise Setup Time	t_S		2			ns
SCLK Fall to CSB Rise Hold Time	t_H		2			ns

¹ This is the time required after a software or hardware reset until SPI access is available again.

ABSOLUTE MAXIMUM RATINGS

Table 4.

Parameter	Rating
VDD1, VDDC, VDDL, VDDQ to VSSA	−0.2 V to +1.2 V
VDD2 to VSSA	−0.3 V to +3.0 V
VDD2NV to VSSA	−0.3 V to +3.0 V
VSS2IN, VSS2OUT to VSSA	−2.5 V to +0.3 V
VDDD, VDDHSI to VSSD	−0.2 V to +1.2 V
VDDIO to VSSD	−0.3 V to +3.0 V
VIN+, VIN− to VSSA	−0.3 V to VDD2 + 0.3 V
L+, L− to VSSA	−0.3 V to VDD2 + 0.3 V
CLK+, CLK− to VSSA	−0.3 V to VDDC + 0.3 V
SYSREF+, SYSREF−, SERDOUT0+, SERDOUT0−, SERDOUT1+, SERDOUT1− to VSSD	−0.3 V to VDDHSI + 0.3 V
SYNCINB+, SYNCINB− to VSSD	−0.3 V to VDDIO + 0.3 V
CSB, SDO, SDIO, SCLK, RESETB, AGC1, AGC2, AGC3, AGC4 to VSSD	−0.3 V to VDDIO + 0.3 V
Normal Operating Temperature Range	−40°C to +85°C
Maximum Junction Temperature Under Bias	125°C
Storage Temperature Range	−65°C to +150°C

Stresses at or above those listed under Absolute Maximum Ratings may cause permanent damage to the product. This is a stress rating only; functional operation of the product at these or any other conditions above those indicated in the operational section of this specification is not implied. Operation beyond the maximum operating conditions for extended periods may affect product reliability.

THERMAL RESISTANCE

Typical θ_{JA} is specified for a 4-layer printed circuit board (PCB) with a solid ground plane in conformance to JESD51-9 2s2p. In addition, metal in direct contact with the package leads from metal traces, through holes, ground, and power planes reduces the value of θ_{JA} .

Table 5. Thermal Resistance

Package Type	θ_{JA}	θ_{JC}	θ_{JB}	Unit
4.3 mm × 5.0 mm WLCSP	26	0.2	4.5	°C/W

ESD CAUTION



ESD (electrostatic discharge) sensitive device. Charged devices and circuit boards can discharge without detection. Although this product features patented or proprietary protection circuitry, damage may occur on devices subjected to high energy ESD. Therefore, proper ESD precautions should be taken to avoid performance degradation or loss of functionality.

PIN CONFIGURATION AND FUNCTION DESCRIPTIONS

	1	2	3	4	5	6	7	8
A	VDDQ	VDD1	VSSA	VDD1	VDD2	L+	L-	VSSA
B	CLK+	VDD1	VDD1	VSSA	VDD1	VDD2	VDD2	VIN+
C	CLK-	VDDC	VDD1	VDD1	VSSA	VDD1	VSSA	VIN-
D	VDDC	VDDC	VDD1	VDDL	VDDL	VSSA	VDD1	VSSA
E	VSSA	VSSA	VSSA	VSSA	VSSA	VSSA	VDD2	VDD2
F	VSSA	VSSA	VSSA	VSSD	VSSD	VSS2IN	VDD2NV	VSSA
G	SYSREF+	VSSD	VSSD	VSSD	VSSD	RESETB	VSS2OUT	VDDIO
H	SYSREF-	VSSD	VDDD	VDDD	VDDD	SDO	AGC4	AGC2
J	VDDHSI	VDDHSI	VDDD	VDDD	VDDD	CSB	AGC3	AGC1
K	SERDOUT0-	SERDOUT0+	SERDOUT1-	SERDOUT1+	SYNCINB+	SYNCINB-	SCLK	SDIO

 1.1V ANALOG SUPPLY	 ANALOG SUPPLY GROUND	 1.1V DIGITAL SUPPLY
 2.5V ANALOG SUPPLY	 DIGITAL SUPPLY GROUND	 -2V ANALOG SUPPLY
 1.8V TO 2.5V DIGITAL I/O ANALOG SUPPLY	 JESD204B INTERFACE	 AGC I/O
 SPI INTERFACE	 ADC I/O	

12348-003

Figure 3. Pin Configuration (Top View, Not to Scale)

Table 6. Pin Function Descriptions

Pin No.	Mnemonic	Description
Σ - Δ ADC Modulator B8, C8 A6, A7 B1, C1	VIN+, VIN- L+, L- CLK+, CLK-	Analog Inputs with Nominal 60 Ω Differential Input Termination. Analog Outputs for External Inductor. Clock Inputs, Nominal 100 Ω Differential Input Termination When the Clock Synthesizer is Disabled. When the clock synthesizer is enabled, each input is 1.2 k Ω ; therefore, an external, 100 Ω differential termination is recommended if the clock source is LVDS or PECL. For a CMOS source driving a long trace, the addition of a series 33 Ω resistor next to the source reduces overshoot seen at CLK+ input pin.
JESD204B Interface K1, K2 K3, K4 G1, H1 K5, K6	SERDOUT0-, SERDOUT0+ SERDOUT1-, SERDOUT1+ SYSREF+, SYSREF- SYNCINB+, SYNCINB-	Lane 0 JESD204B Digital CML Outputs. Lane 1 JESD204B Digital CML Outputs. JESD204B SYSREF Inputs. Note that these pins have no differential termination. JESD204B CMOS or LVDS SYNC Inputs. Selectable via Register 0x1E7, Bit 2. Default CMOS mode uses the SYNCINB+ pin only. LVDS mode has a 100 Ω differential termination.

Pin No.	Mnemonic	Description
CMOS Input/Outputs J8, H8, J7, H7	AGC1, AGC2, AGC3, AGC4	AGC Bidirectional Inputs/Outputs. By default, AGC2 and AGC1 are inputs, whereas AGC4 and AGC3 are outputs. If the AGC2 and AGC1 pins are unused, connect them to VSSD via a 100 k Ω resistor.
J6	CSB	Serial Port Enable Input. Active low.
K8	SDIO	Serial Port Input/Output.
H6	SDO	Serial Port Output.
K7	SCLK	Serial Clock Input.
G6	RESETB	Active Low Reset Input. This pin places digital logic and SPI registers into a known default state. Leave this pin open if unused because it has an internal pull-up resistor.
Power Supplies		
G8	VDDIO	Digital Supply Input for CMOS Input/Outputs (1.8 V to 2.5 V).
J1, J2	VDDHSI	Digital 1.1 V Supply Input for the High Speed Serial Interface.
H3 to H5, J3 to J5	VDDD	Digital 1.1 V Supply Input.
F4, F5, G2 to G5, H2	VSSD	Digital Supply Return.
A1	VDDQ	Analog 1.1 V Supply Input for the CLK Synthesizer Charge Pump and Dividers.
C2, D1, D2	VDDC	Analog 1.1 V Supply Input for the CLK Synthesizer VCO.
D4, D5	VDDL	Analog 1.1 V Supply Input for the ADC.
A2, A4, B2, B3, B5, C3, C4, C6, D3, D7	VDD1	Analog 1.1 V Supply Input for the ADC.
A5, B6, B7, E7, E8	VDD2	Analog 2.5 V Supply Input.
A3, A8, B4, C5, C7, D6, D8, E1 to E6, F1 to F3, F8	VSSA	Analog Supply Return.
Negative Voltage Regulator		
F7	VDD2NV	Analog 2.5 V Supply Input.
G7	VSS2OUT	Internal -2.0 V Supply Output. Connect this pin to VSS2IN.
F6	VSS2IN	Analog -2.0 V Supply Input. Connect this pin to VSS2OUT.

TYPICAL PERFORMANCE CHARACTERISTICS

NOMINAL PERFORMANCE FOR IF = 115 MHz (DIRECT SAMPLING VHF RECEIVER)

$F_{IF} = 115$ MHz, $BW = 20$ MHz, $F_{ADC} = 2.4$ GHz, attenuator = 0 dB, $L_{EXT} = 100$ nH, maximum PIN_0dBFS setting, $f_{DATA_IQ} = 75$ MSPS, nominal supplies, shuffler enabled (every 4 clock cycles), with default threshold settings, unless otherwise noted.

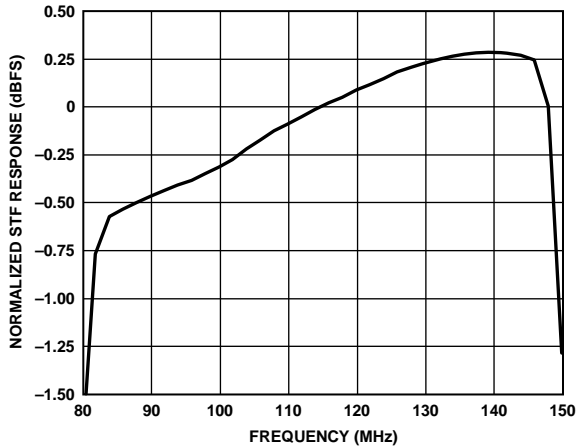

Figure 4. IF Pass Band Flatness (Includes Digital Filter)

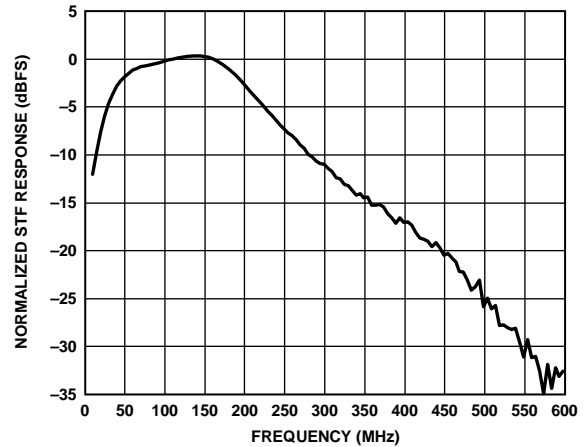

Figure 7. Wideband Frequency Response (Before Digital Filter)

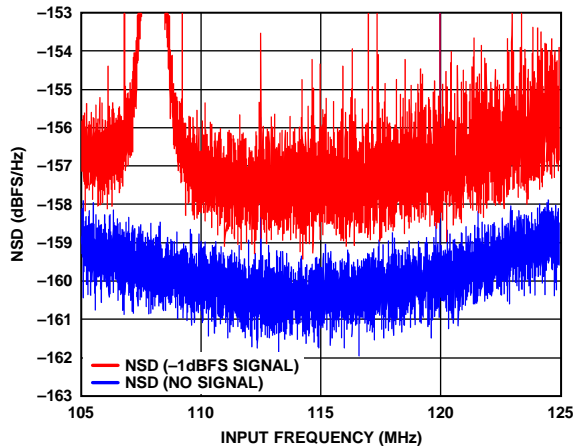

Figure 5. NSD With and Without Full-Scale CW at 108 MHz

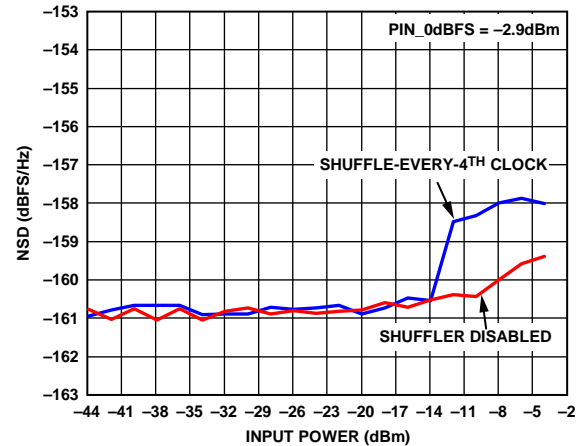

Figure 8. NSD vs. CW Input Power, CW at 108 MHz (NSD Measured at IF Center of 115 MHz)

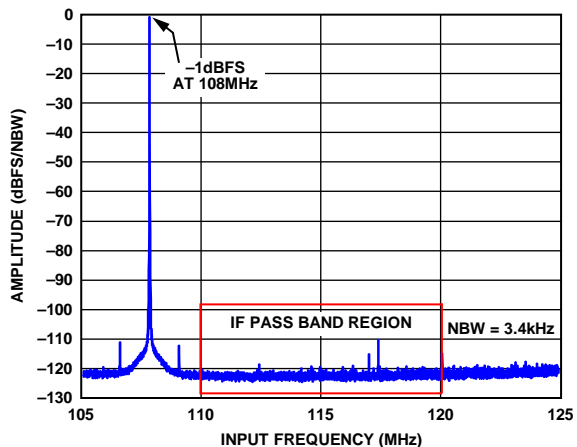

Figure 6. Spectral Plot of IF Pass Band Region with -1 dBFS CW at 108 MHz

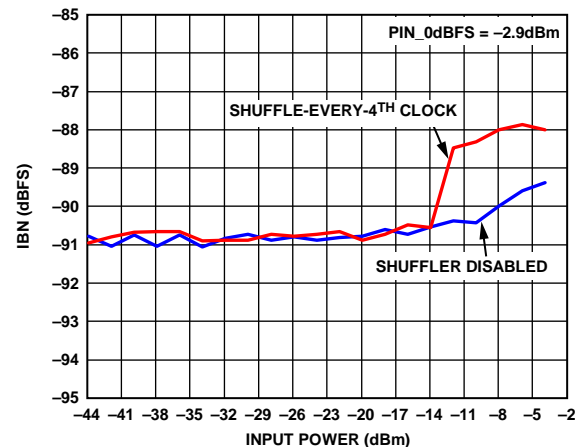

Figure 9. Integrated In-Band Noise (IBN) in IF Pass Band Region of 10 MHz vs. Swept Single Tone Input Power with CW at 130 MHz

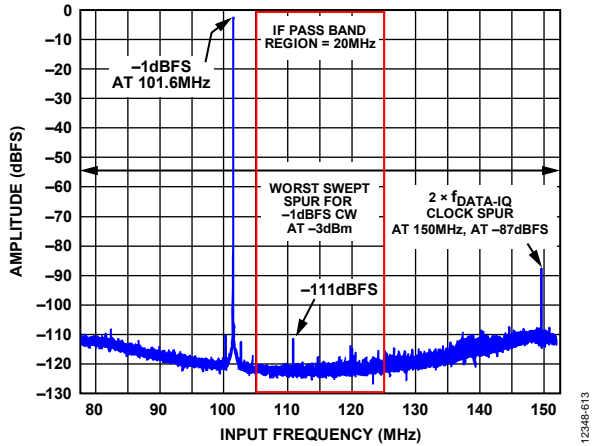

Figure 10. Worst Spur Falling in 75 MHz Pass Band for Swept CW from 77.5 MHz to 152.5 MHz

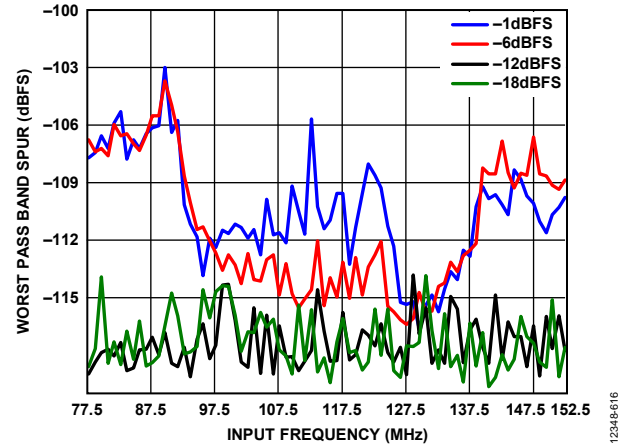

Figure 13. Worst Pass Band Spur with Swept CW from 77.5 MHz to 150 MHz, over $P_{IN} = -1$ dBFS, -6 dBFS, -12 dBFS, and -18 dBFS

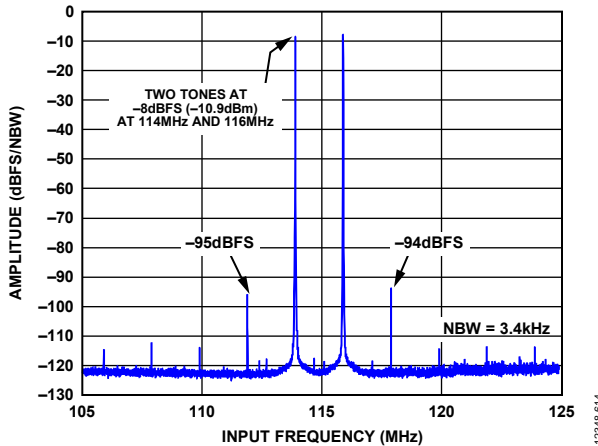

Figure 11. Two-Tone IMD Performance ($f_1 = 114$ MHz, $f_2 = 116$ MHz)

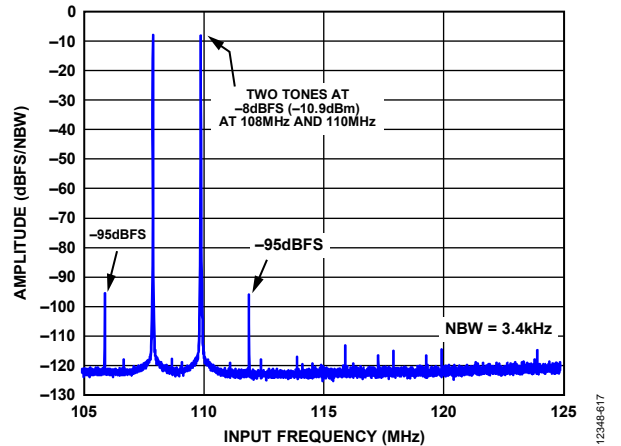

Figure 14. Two-Tone IMD Performance ($f_1 = 108$ MHz, $f_2 = 110$ MHz)

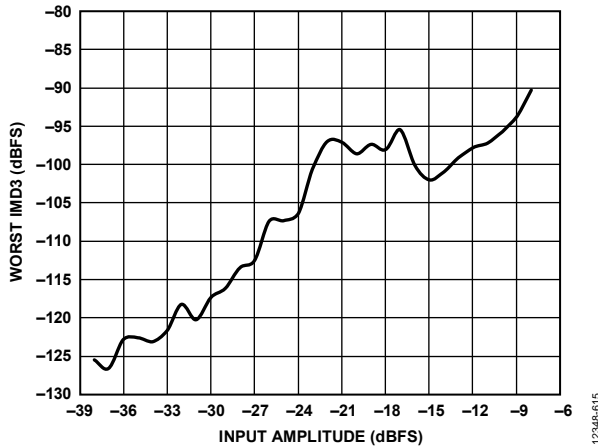

Figure 12. Swept Two-Tone Worst IMD3 vs. Tone Input Amplitude ($f_1 = 113$ MHz, $f_2 = 118$ MHz)

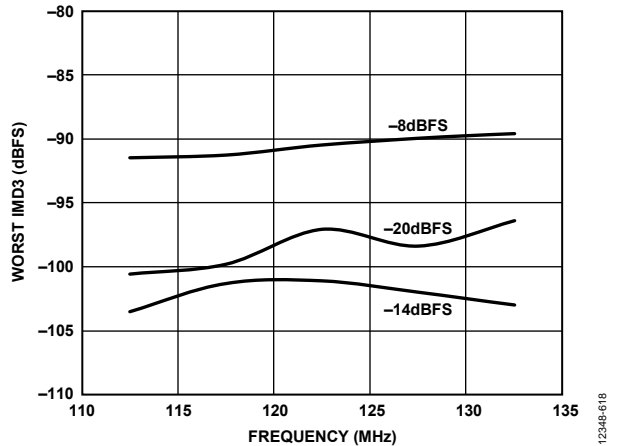

Figure 15. Swept Two-Tone Worst IMD3 vs. Frequency over Pass Band ($\Delta f = 5$ MHz for Two Tones, $P_{IN} = -8$ dBFS, -14 dBFS, and -20 dBFS)

NOMINAL PERFORMANCE FOR IF = 140 MHz (μ W POINT-TO-POINT RECEIVERS)

f_{IF} = 140 MHz, BW = 56 MHz or 112 MHz, F_{ADC} = 3.2 GHz, attenuator = 0 dB, L_{EXT} = 43 nH, maximum PIN_0dBFS setting, f_{DATA_IQ} = 200 MSPS, nominal supplies, shuffler enabled (every clock cycle), with default threshold settings, unless otherwise noted.

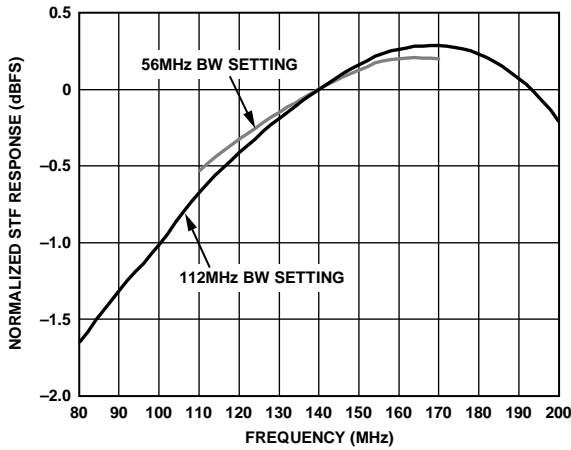

Figure 16. IF Pass Band Flatness (Includes Digital Filter)

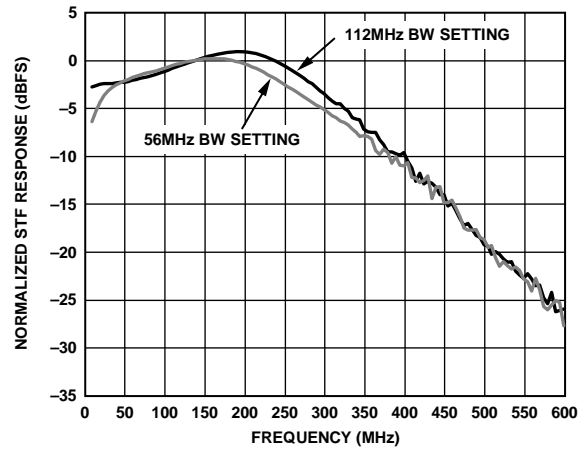

Figure 19. Wideband Frequency Response (Before Digital Filter)

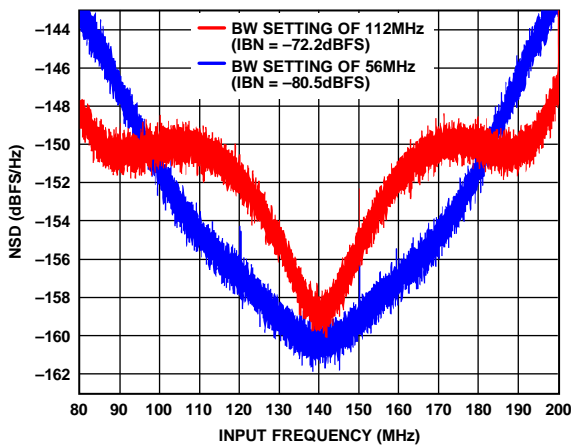

Figure 17. NSD with No Signal, IBN = 112 MHz and 56 MHz

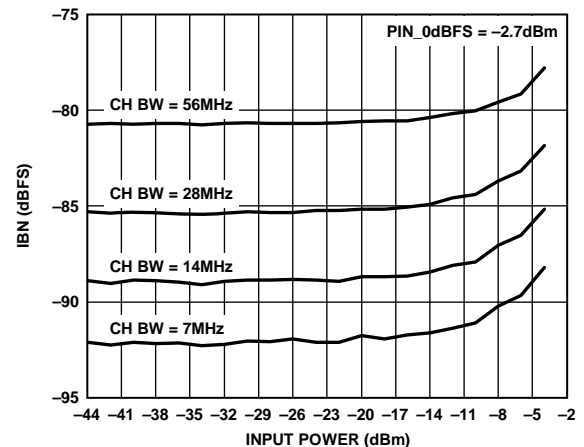

Figure 20. IBN vs. Swept Single Tone Input Power over Channel BW = 7 MHz, 14 MHz, 28 MHz, and 56 MHz, CW Blocker at 350 MHz

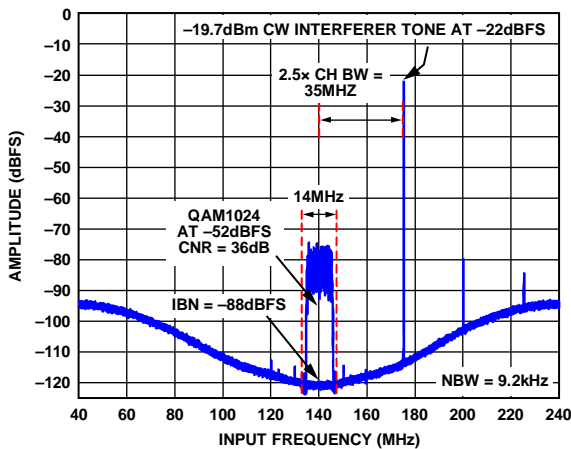

Figure 18. Spectral Plot of CW Interferer Dynamic Range for QAM1024, Channel BW = 14 MHz at Sensitivity Level with CW Interferer 30 dB Higher at 35 MHz Offset

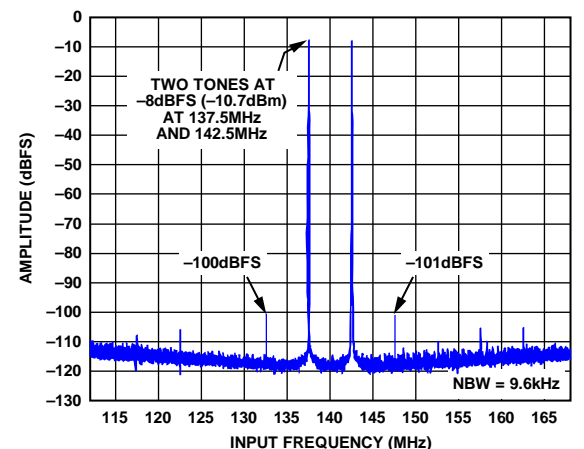

Figure 21. Two-Tone IMD Performance (f_1 = 137.5 MHz, f_2 = 142.5 MHz)

NOMINAL PERFORMANCE FOR IF = 181 MHz (WIRELESS INFRASTRUCTURE RECEIVER)

$F_{IF} = 181 \text{ MHz}$, $BW = 75 \text{ MHz}$, $F_{ADC} = 2.94912 \text{ GHz}$, attenuator = 0 dB, $L_{EXT} = 43 \text{ nH}$, maximum PIN_0dBFS setting, $f_{DATA_IQ} = 122.88 \text{ MSPS}$, shuffler enabled (every clock cycle), with default threshold settings, unless otherwise noted.

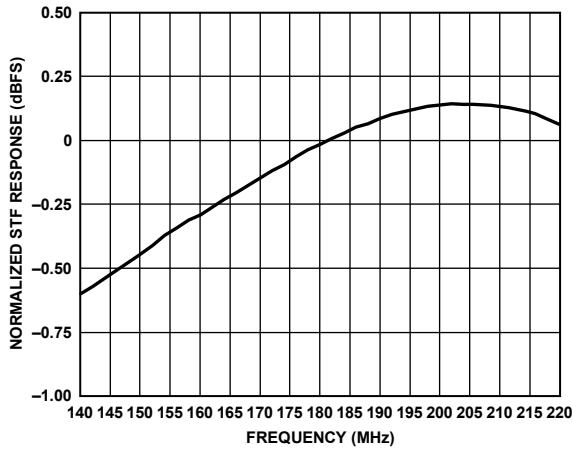

Figure 22. IF Pass Band Flatness (Includes Digital Filter)

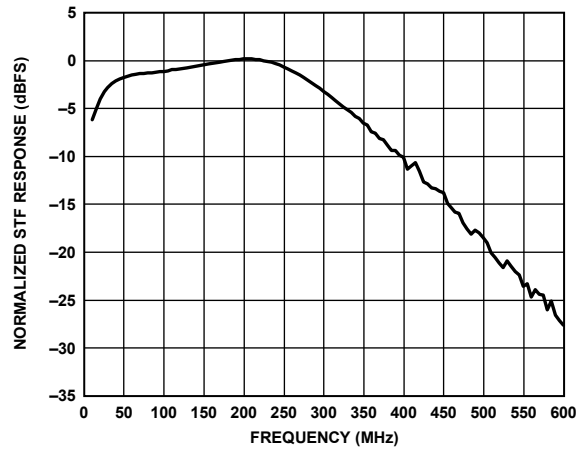

Figure 25. Wideband Frequency Response (Before Digital Filter)

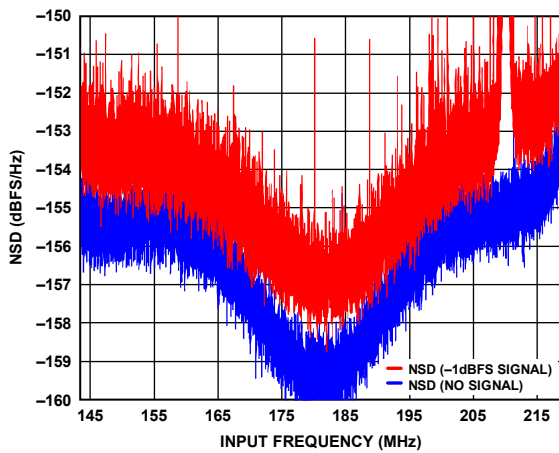

Figure 23. NSD With and Without Full-Scale CW at 210 MHz

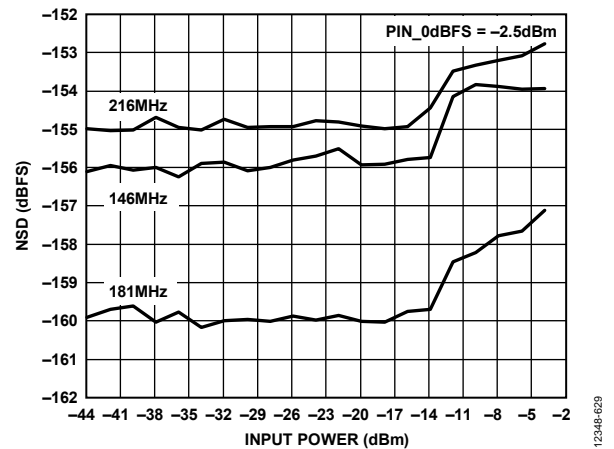

Figure 26. NSD vs. CW Input Power, CW = 210 MHz (NSD Measured at 181 MHz as well as 146 MHz and 216 MHz Band Edges)

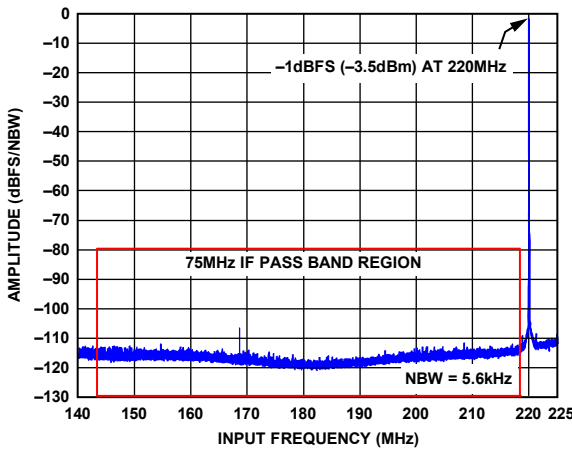

Figure 24. Spectral Plot of IF Pass Band Region with -1 dBFS CW at 220 MHz

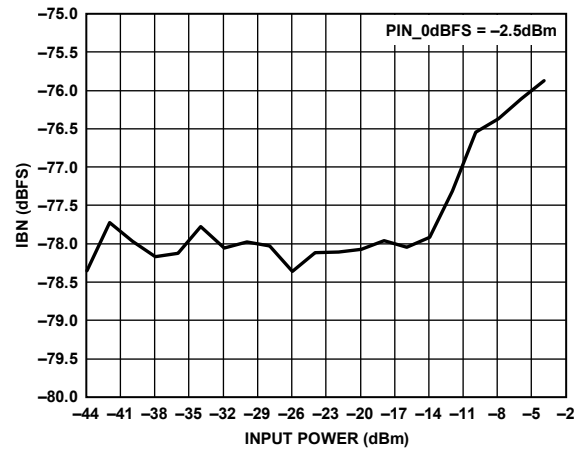

Figure 27. IBN in IF Pass Band Region (BW = 75 MHz) vs. Swept Single Tone Input Power with CW at 220 MHz

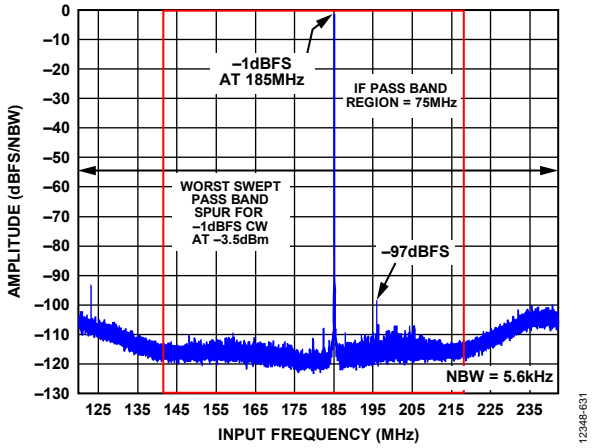

Figure 28. Worst Spur Falling in 75 MHz Pass Band for Swept CW from 122.88 MHz to 245.76 MHz

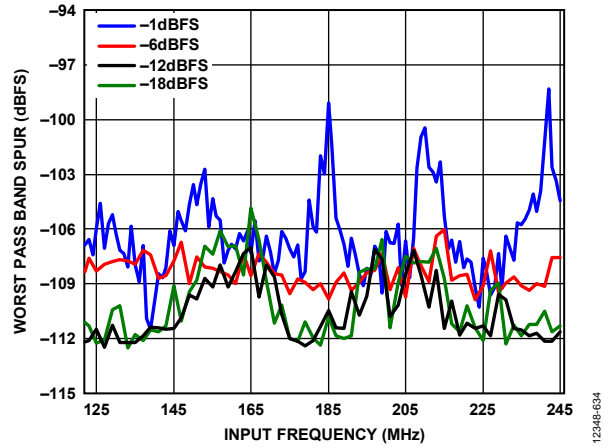

Figure 31. Swept Worst Pass Band Spur with CW Swept from 122.88 MHz to 245.76 MHz, over $P_{IN} = -1$ dBFS, -6 dBFS, -12 dBFS, and -18 dBFS

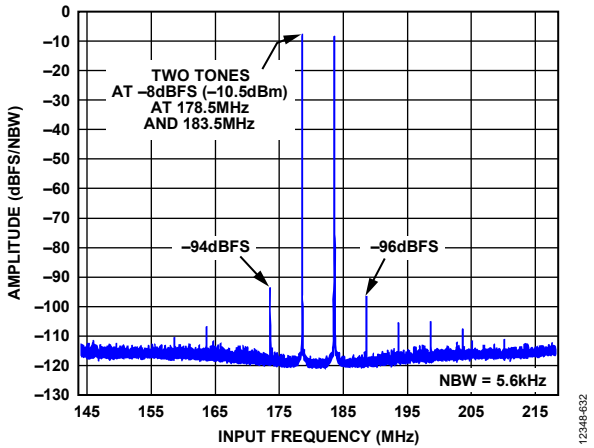

Figure 29. Two-Tone IMD Performance ($f_1 = 178.5$ MHz, $f_2 = 183.5$ MHz)

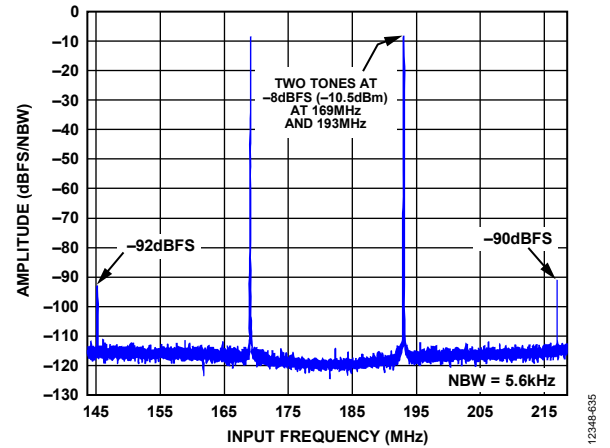

Figure 32. Two-Tone IMD Performance ($f_1 = 169$ MHz, $f_2 = 193$ MHz)

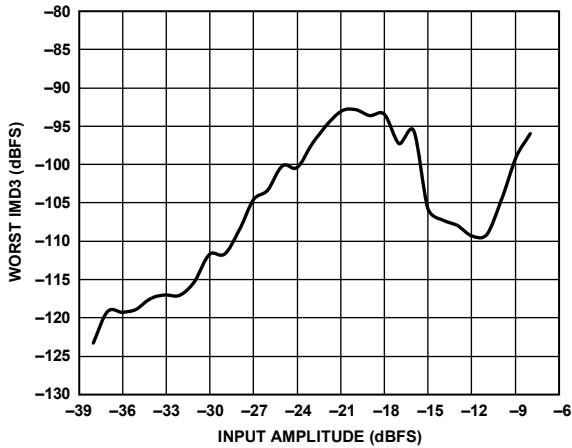

Figure 30. Swept Two-Tone Worst IMD3 vs. Tone Level (dBFS) ($f_1 = 178.5$ MHz, $f_2 = 183.5$ MHz)

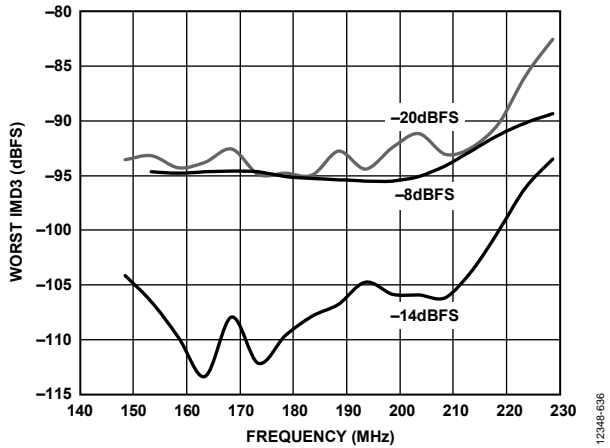

Figure 33. Swept Two-Tone Worst IMD3 vs. Frequency over Pass Band ($\Delta f = 5$ MHz for Two Tones, $P_{IN} = -8$ dBFS, -14 dBFS, and -20 dBFS)

12348-631

12348-634

12348-632

12348-635

12348-633

12348-636

NOMINAL PERFORMANCE FOR IF = 250 MHz AND BW = 75 MHz

$f_{IF} = 250$ MHz, $BW = 75$ MHz, $F_{ADC} = 3.2$ GHz, attenuator = 0 dB, $L_{EXT} = 19$ nH, maximum PIN_0dBFS setting, $f_{DATA_IQ} = 200$ MSPS, nominal supplies, shuffler enabled (every clock cycle), with default threshold settings, unless otherwise noted.

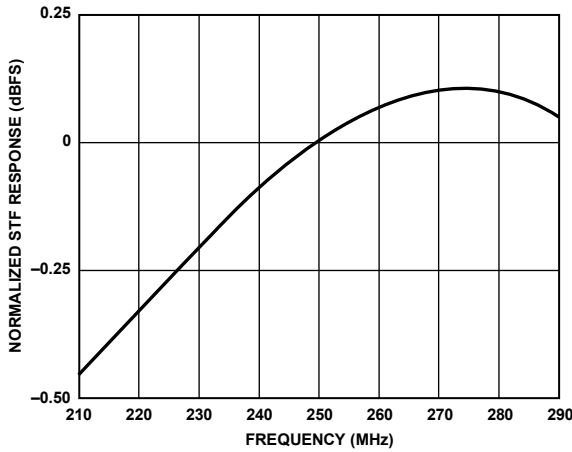

Figure 34. IF Pass Band Flatness (Includes Digital Filter)

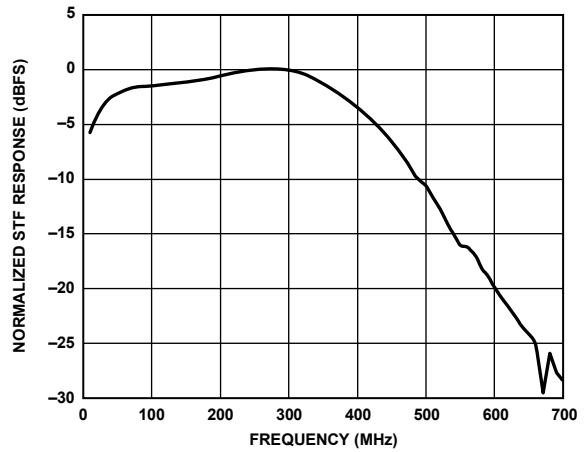

Figure 37. Wideband Frequency Response (Before Digital Filter)

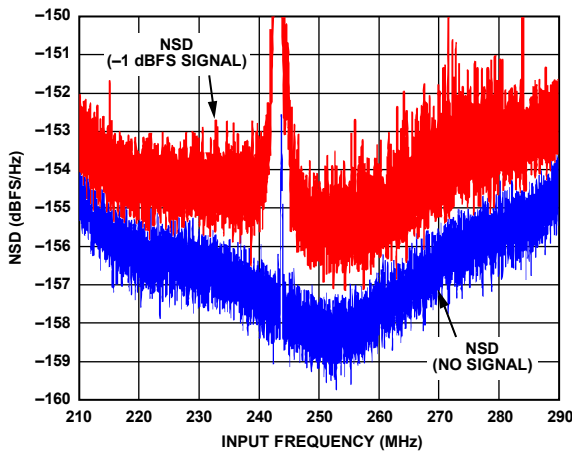

Figure 35. NSD With and Without Full-Scale CW at 243 MHz

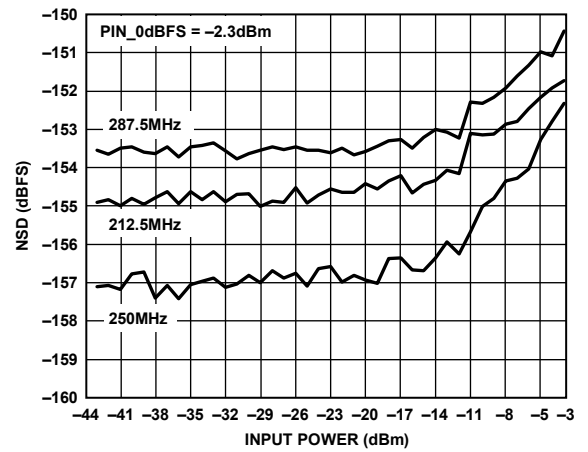

Figure 38. NSD vs. CW Input Power, CW at 243 MHz (NSD Measured at 250 MHz as well as 212.5 MHz and 287.5 MHz Band Edges)

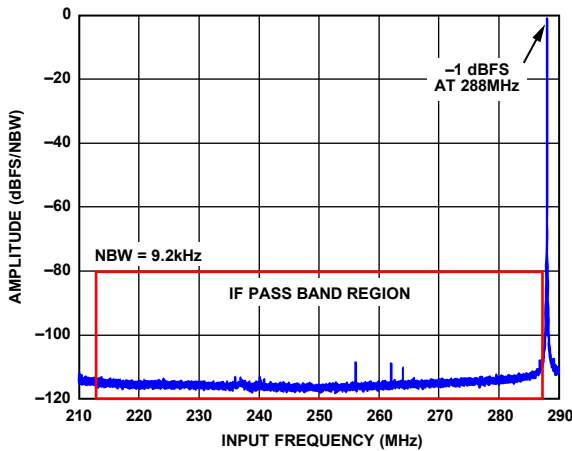

Figure 36. Spectral Plot of IF Pass Band Region with -1 dBFS CW at 288 MHz

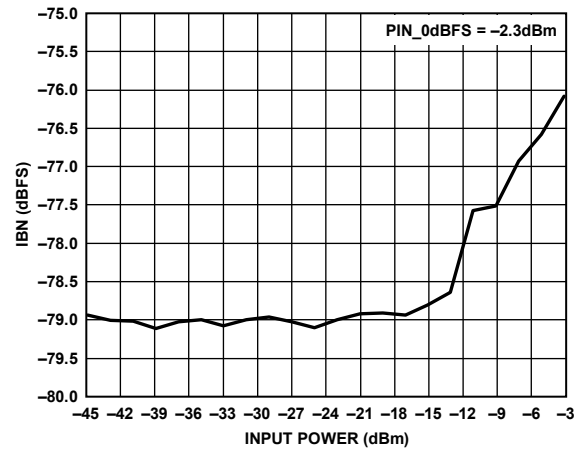

Figure 39. IBN in the Pass Band Region (BW = 75 MHz) vs. Swept Single Tone Input Power with CW at 288 MHz

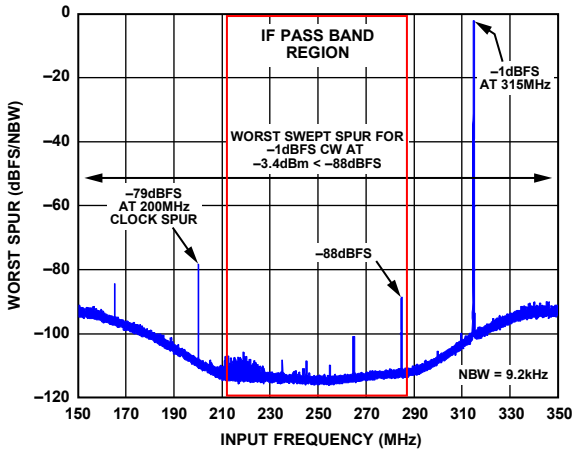

Figure 40. Worst Spur Falling in 75 MHz Pass Band for Swept CW from 150 MHz to 300 MHz

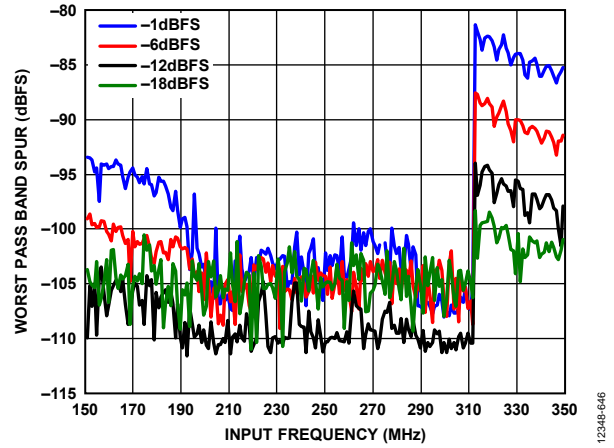

Figure 43. Swept Worst Pass Band Spur with CW Swept from 150 MHz to 300 MHz for $P_{IN} = -1$ dBFS, -6 dBFS, -12 dBFS, and -18 dBFS

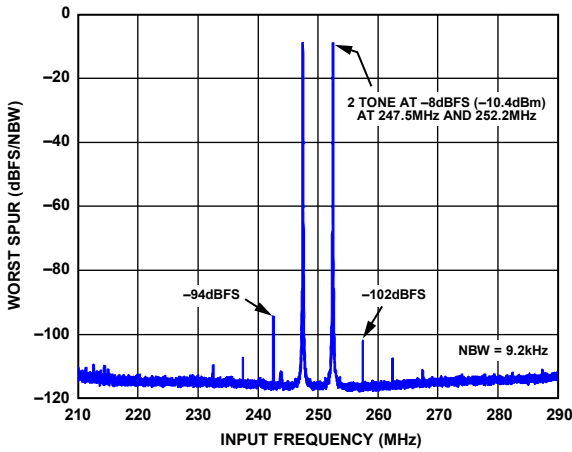

Figure 41. Two-Tone IMD Performance ($f_1 = 247.5$ MHz, $f_2 = 252.5$ MHz)

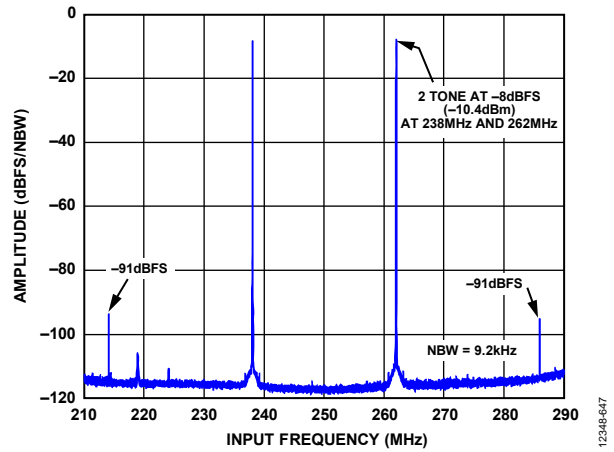

Figure 44. Two-Tone IMD Performance ($f_1 = 238$ MHz, $f_2 = 262$ MHz)

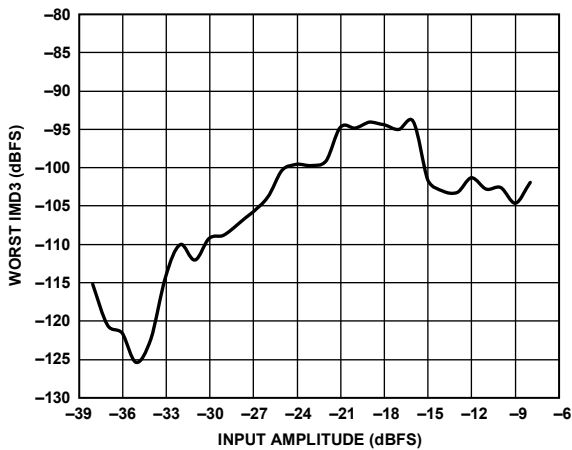

Figure 42. Swept Two-Tone Worst IMD3 vs. Tone Level (dBFS) ($f_1 = 252.5$ MHz, $f_2 = 257.5$ MHz)

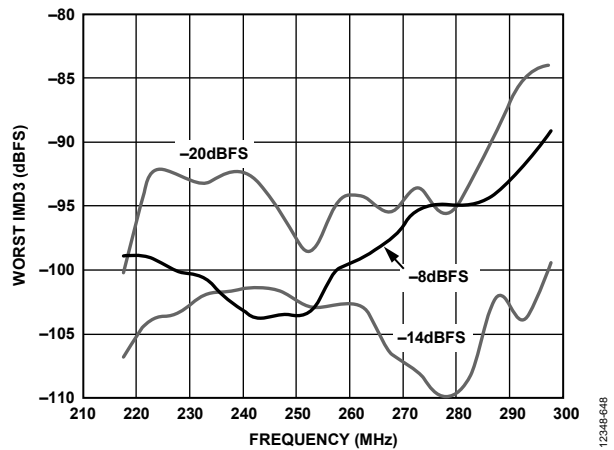

Figure 45. Swept Two-Tone Worst IMD3 vs. Frequency over Pass Band ($\Delta f = 5$ MHz for Two Tones, $P_{IN} = -8$ dBFS, -14 dBFS, and -20 dBFS)

12348-643

12348-646

12348-644

12348-647

12348-645

12348-648

NOMINAL PERFORMANCE FOR IF = 350 MHz AND BW = 160 MHz

$F_{IF} = 350$ MHz, $BW = 160$ MHz, $F_{ADC} = 3.2$ GHz, attenuator = 0 dB, $L_{EXT} = 10$ nH, maximum PIN_0dBFS setting, $f_{DATA_IQ} = 266.7$ MSPS, shuffler enabled (every clock cycle), with default threshold settings, unless otherwise noted.

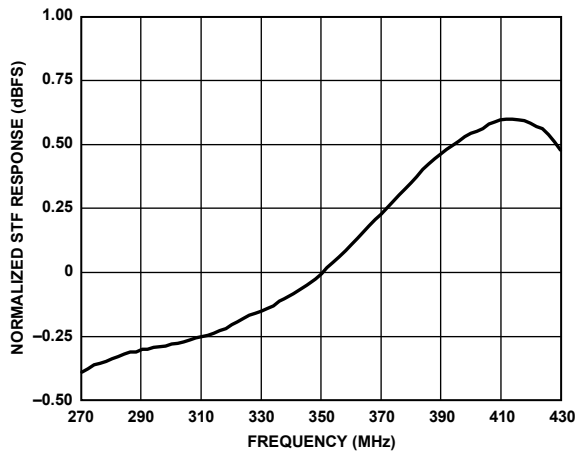

Figure 46. IF Pass Band Flatness (Includes Digital Filter)

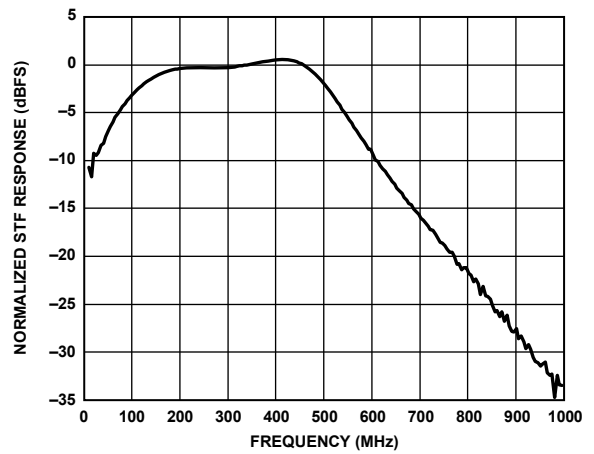

Figure 49. Wideband Frequency Response (Before Digital Filter)

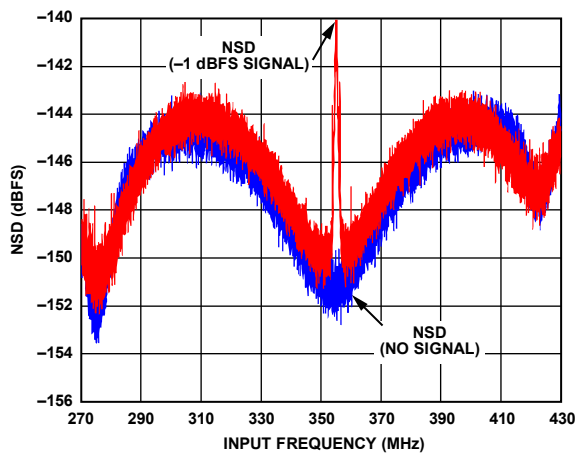

Figure 47. NSD With and Without Full-Scale CW at 355 MHz

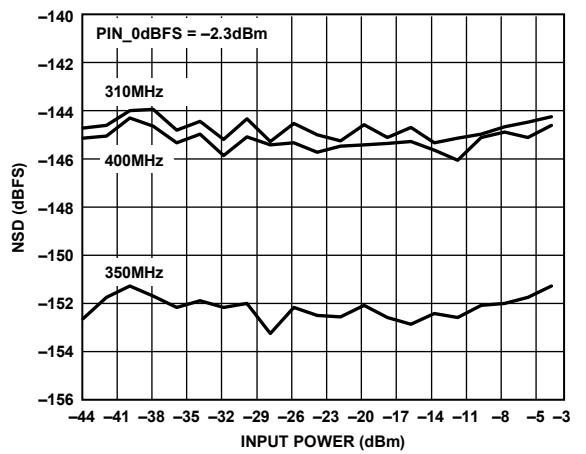

Figure 50. NSD vs. CW Input Power, CW at 355 MHz (NSD Measured at 350 MHz as well as 350 MHz and 400 MHz Band Edges)

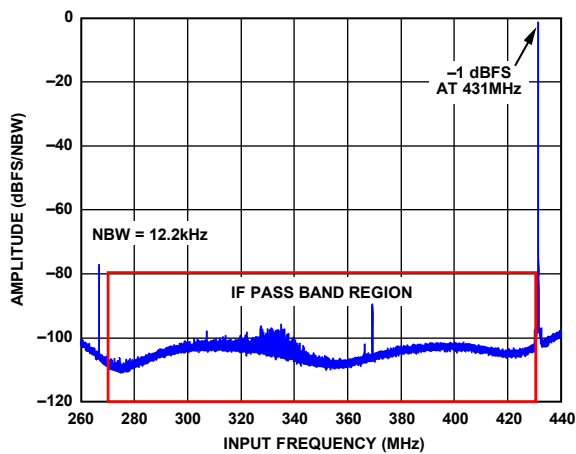

Figure 48. Spectral Plot of IF Pass Band Region with -1 dBFS CW at 431 MHz

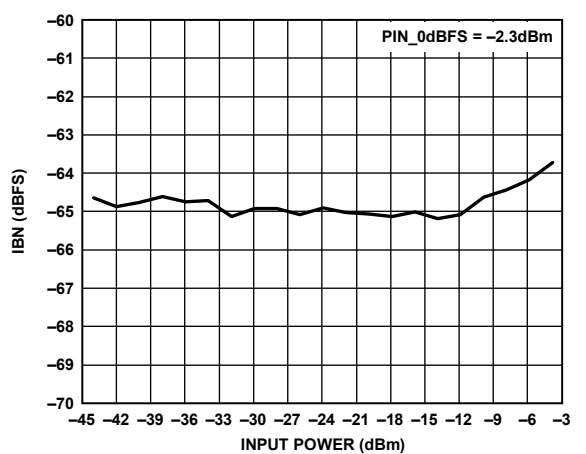

Figure 51. IBN in IF Pass Band Region (BW = 160 MHz) vs. Swept Single Tone Input Power with CW at 431 MHz

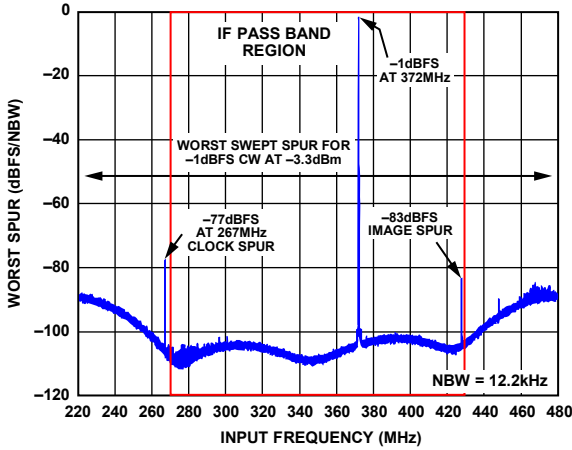

Figure 52. Worst Spur Falling in 160 MHz Pass Band for Swept CW from 217 MHz to 484 MHz

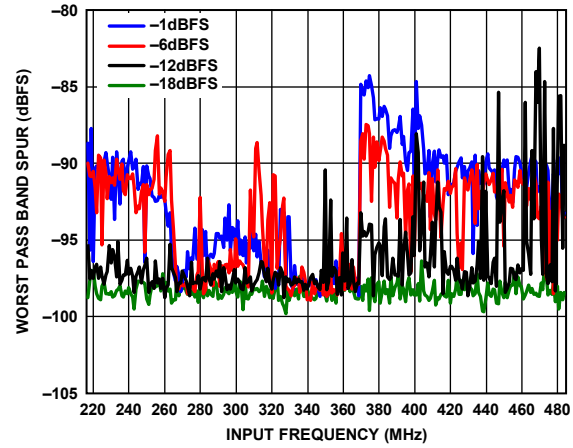

Figure 55. Swept Worst Pass Band Spur with CW Swept from 217 MHz to 484 MHz over $P_{IN} = -1$ dBFS, -6 dBFS, -12 dBFS, and -18 dBFS

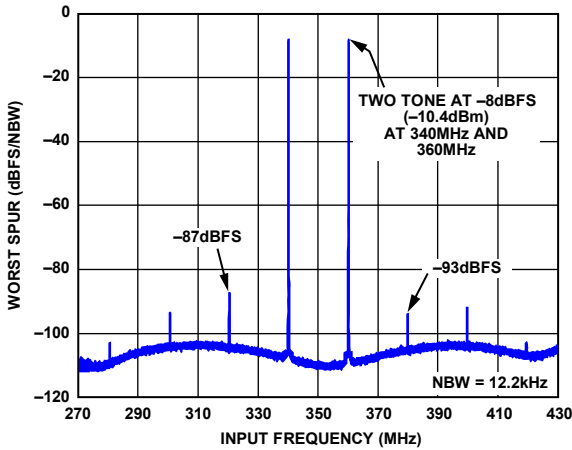

Figure 53. Two-Tone IMD Performance ($f_1 = 340$ MHz, $f_2 = 360$ MHz)

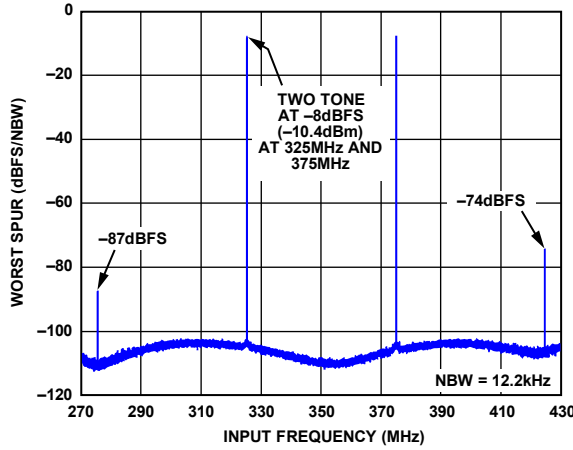

Figure 56. Two-Tone IMD Performance ($f_1 = 325$ MHz, $f_2 = 375$ MHz)

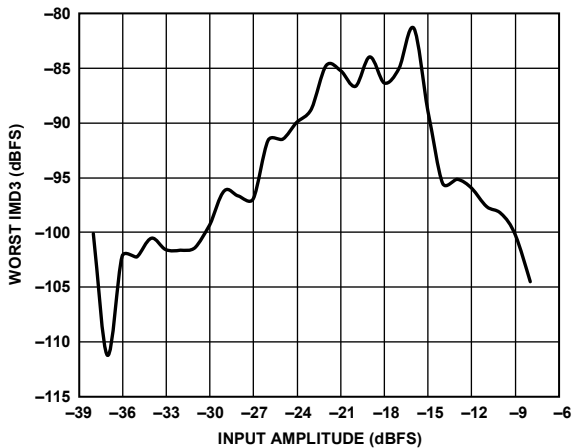

Figure 54. Swept Two-Tone Worst IMD3 vs. Tone Level (dBFS) ($f_1 = 347.5$ MHz, $f_2 = 352.5$ MHz)

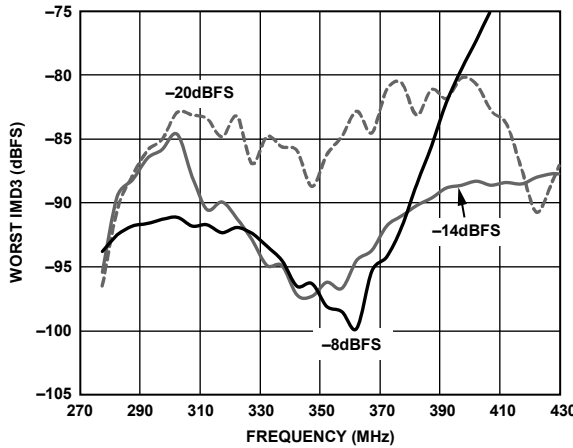

Figure 57. Swept Two-Tone Worst IMD3 vs. Frequency over Pass Band ($\Delta f = 5$ MHz for Two Tones, $P_{IN} = -8$ dBFS, -14 dBFS, and -20 dBFS)

EQUIVALENT CIRCUITS

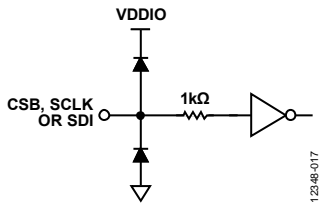

Figure 58. Equivalent CSB or SCLK Input Circuit

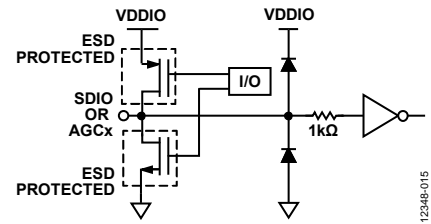

Figure 62. Equivalent SDIO or AGCx Input/Output Circuit

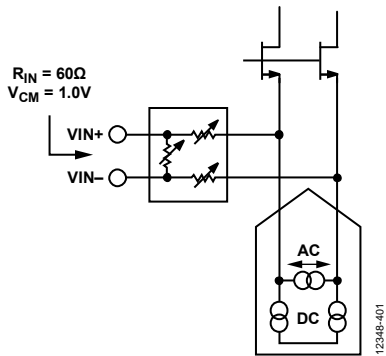

Figure 59. Equivalent Analog Input

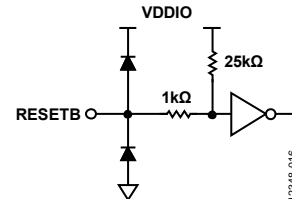

Figure 63. Equivalent RESETB Input Circuit

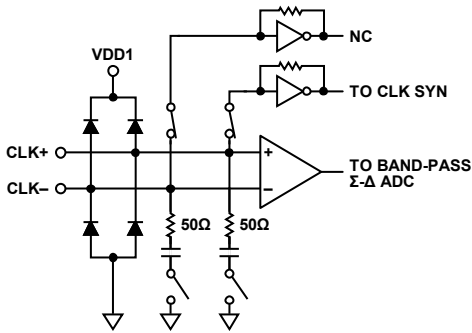

Figure 60. Equivalent Clock Input Circuit

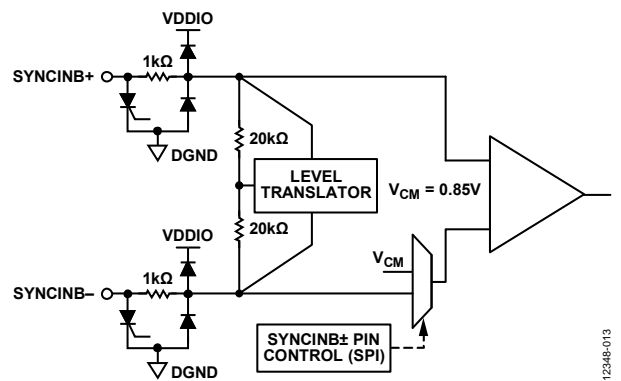

Figure 64. Equivalent SYNCIN± Input

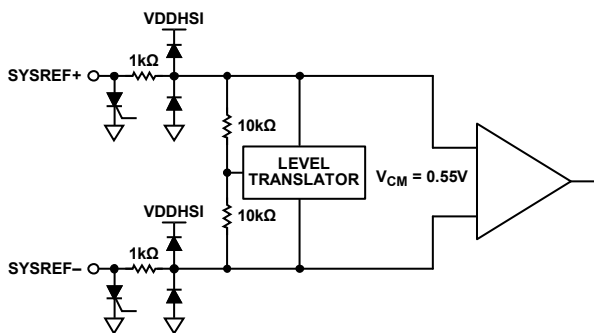

Figure 61. Equivalent SYSREF± Input

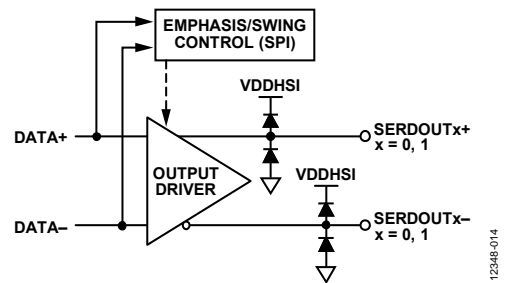

Figure 65. Digital CML Output Circuit

TERMINOLOGY

Noise Figure (NF)

NF is the degradation in SNR performance (in dB) of an input signal having a noise density of -174 dBm/Hz after it passes through a component or system. Mathematically,

$$NF = 10 \times \log(SNR_{IN}/SNR_{OUT})$$

The noise figure of the [AD6676](#) is determined by the equation

$$NF = P_{IN} - (10 \times \log(BW)) - (-174.0 \text{ dBm/Hz}) - SNR$$

where:

P_{IN} is the input power of an unmodulated carrier.

BW is the noise measurement bandwidth.

-174.0 dBm/Hz is the thermal noise floor at 290 K.

SNR is the measured signal-to-noise ratio in dB of the [AD6676](#).

Note that P_{IN} is set to a low level (that is, < -40 dBm) to minimize any degradation in measured SNR due to phase noise from either the input signal or Σ - Δ ADC clock source.

Noise Spectral Density (NSD)

NSD is the noise power normalized to 1 Hz bandwidth (at a particular frequency) relative to the full scale of the ADC (dBFS) and hence is given in units of dBFS/Hz. The [AD6676](#), being a Σ - Δ ADC, displays a uneven NSD across its IF pass band. Both the worst-case NSD as well as NSD at the pass band center are reported. Note that NSD is calculated from the IBN measured over a 5 MHz bandwidth.

In-Band Noise (IBN)

IBN is the integrated noise power measured over a user defined bandwidth relative to the full scale of the ADC (dBFS). This bandwidth is typically equal to the IF pass band setting (BW) of the [AD6676](#), unless otherwise noted.

Input Second-Order Intercept (IIP2)

IIP2 is a figure of merit used to quantify the second-order intermodulation distortion (IMD2) of a component or system. Two equal amplitude unmodulated carriers at specified frequencies (f_1 and f_2) injected into a nonlinear system exhibiting second-order nonlinearities produce IMD components at $f_1 - f_2$ and $f_1 + f_2$. For the [AD6676](#), the two frequencies are situated at $\frac{1}{2}$ the IF frequency (with a 2 MHz offset) at a power level corresponding to -6 dBFS at the IF center frequency with only the intermodulation term at $f_1 + f_2$ considered. IIP2 is the extrapolated tone power at which the intermodulation terms and the input tones have equal amplitude.

$$IIP2 = P_{IN} - IMD2$$

Input Third-Order Intercept (IIP3)

IIP3 is a figure of merit used to quantify the third-order intermodulation distortion (IMD3) of a component or system. Two equal amplitude unmodulated carriers at specified frequencies (f_1 and f_2) injected into a nonlinear system exhibiting third-order nonlinearities produce IMD components at $2f_1 - f_2$ and $2f_2 - f_1$. IIP3 is the extrapolated tone power at which the intermodulation terms and the input tones have equal amplitude.

$$IIP3 = P_{IN} - IMD3/2$$

Note that the third-order IMD performance of an ADC does not necessarily follow the 3:1 rule that is typical of RF/IF linear devices. IMD performance is dependent on the dual tone frequencies, signal input levels, and ADC clock rate.

Worst In-Band Spur (SFDR)

Worst in-band spur is the worst spur falling in the IF pass band relative to the full scale of the ADC (dBFS) when a single tone with defined power level is stepped (typically 1 MHz increments) across a user defined frequency range. Note that this worst spur can often be an image (or clock) related spur depending on the IF, BW, and IQ output data rate setting of the [AD6676](#) and on the sweep range.

Signal Transfer Function (STF)

STF is the frequency response of the output signal of the ADC relative to a swept single tone at its input. The STF presented for different [AD6676](#) setup conditions in the Typical Performance Characteristics section shows the STF over the IF pass band after the digital filter to highlight pass band flatness. The wideband STF response is measured before the digital filter to highlight the pass band response of the [AD6676](#) Σ - Δ ADC.

THEORY OF OPERATION

OVERVIEW

The AD6676 is a highly integrated and flexible IF subsystem capable of digitizing IF signals. The ability to tune the IF frequency and bandwidth allows the Σ - Δ ADC to be optimized for different applications while trading off bandwidth for dynamic range. To facilitate its evaluation and design in, a software tool that is part of the AD6676EBZ development platform must be used to configure and evaluate the device. This tool saves the SPI initialization and configuration sequence to a file for later use. A screenshot of the GUI front panel (see Figure 66) shows the different user specified application parameters that configure the AD6676. The following discussion provides more insight into the device operation and how these application parameters affect performance.

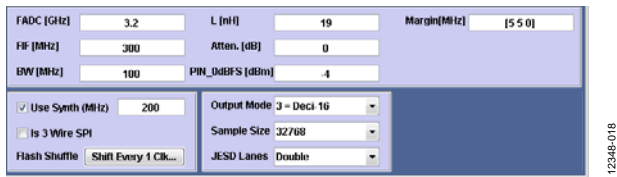

Figure 66. Screenshot of AD6676 GUI Software Tool that Facilitates Device Configuration and Evaluation

A functional block diagram of the AD6676 is shown Figure 67. The focal point of the AD6676 is its continuous time, band-pass Σ - Δ ADC that operates with a clock rate between 2.0 GHz and 3.2 GHz. An on-chip controller configures the Σ - Δ ADC based on the user specified application parameters. The Σ - Δ ADC provides exceptional dynamic range and pass band flatness within the desired IF span while limiting out-of-band peaking to less than 0.5 dB. An on-chip clock synthesizer supplies a 2.94 GHz to 3.2 GHz Σ - Δ ADC clock. Alternatively, an external clock can be supplied for lower clock rates or improved phase noise performance.

On-chip digital signal processing blocks include a quadrature digital downconverter (QDDC) followed by selectable decimation filters supporting decimation factors of 12, 16, 24, or 32. The QDDC performs a complex shift of the desired IF pass band such that it is centered about dc, that is, zero IF. Cascaded decimation filters remove the inherent out-of-band noise of the ADC along with any other out-of-band signal content such that the 16-bit complex IQ data is reduced to a more manageable data rate for transfer to the host via a single or dual lane JESD204B interface supporting up to 5.333 Gbps lane rates.

The AD6676 also includes features for AGC support and/or level-planning optimization. AGC support includes the ability to monitor peak power at the Σ - Δ ADC output or rms power after the first internal decimation stage. The host can initiate fast AGC action by configuring various flags whose status are made available on the AGC4 to AGC1 pins. Flags can be set with programmable thresholds indicating whether the signal level is above or below a defined level. A 27 dB attenuator with a step size of 1 dB is available for IF AGC control or level planning optimization during initial system calibration. Alternatively, the nominal 0 dBFS full-scale input power level (PIN_0dBFS) of -2 dBm can be reduced by up to 12 dB thus further reducing the RF/IF gain requirements. The SPI programs numerous parameters of the AD6676, allowing the device to be optimized for a variety of applications.

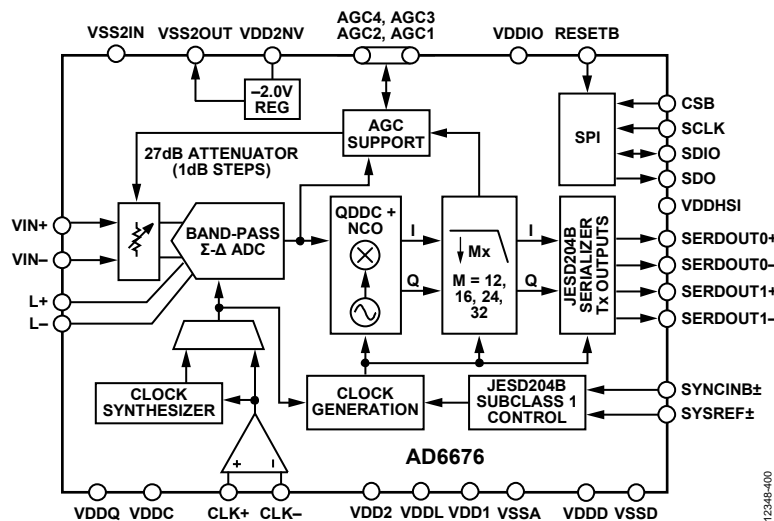

Figure 67. Functional Block Diagram

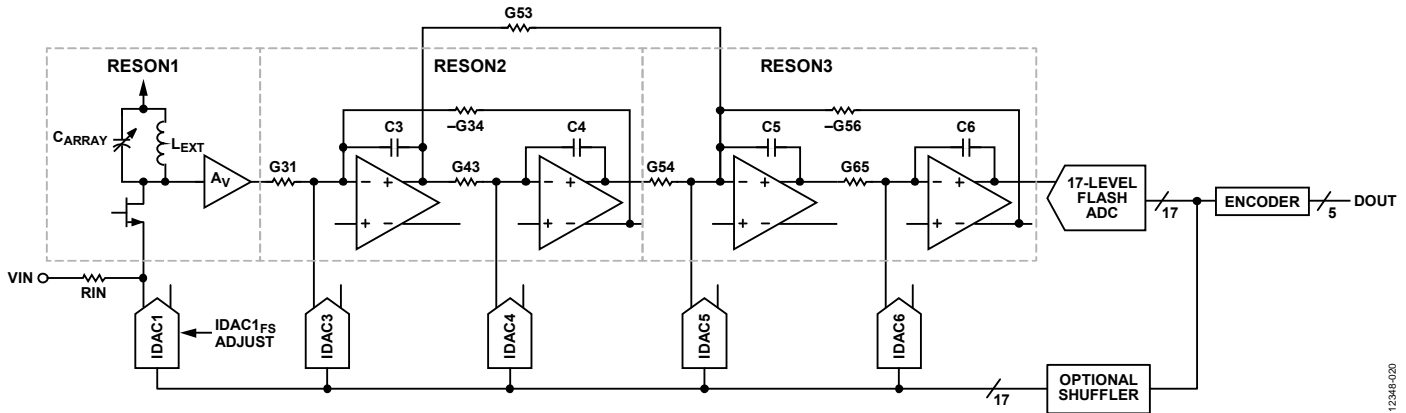

Figure 68. Simplified Single-Ended Representation of the Band-Pass Σ - Δ ADC Modulator

BAND-PASS Σ - Δ ADC ARCHITECTURE

Figure 68 shows a simplified single-ended representation of the AD6676 band-pass Σ - Δ ADC. It is a sixth-order modulator consisting of three cascaded second-order continuous-time resonators with feedback DACs and an oversampling quantizer. The first resonator (RESON1) is based on a LC tank with its resonant frequency tuned via C_{ARRAY} to the IF center while the second and third resonators (RESON2 and RESON3) are active RC-based with their resonant frequencies tuned to frequencies offset symmetrically about the IF. These resonant frequencies correspond to the zero locations of the Σ - Δ ADC quantization noise and are set according to the user defined IF frequency and bandwidth.

A 17-level flash ADC oversamples the analog output of RESON3 with the digital output of the flash ADC feeding back to each of the resonators via current mode DACs (IDACx). Note that because the ADC thermometer code output can range from -8 to $+8$, it is represented by five bits that are passed to the AD6676 digital path. The IDAC1 full-scale current setting ($IDAC1_{FS}$) sets the maximum full-scale input power level (PIN_0DBFS). The full-scale settings of the other IDACs set the pole location of the modulator to achieve a flat pass band response. Lastly, a programmable shuffler follows the flash ADC to improve the linearity performance of the AD6676 under large signal conditions.

The tunable nature of the Σ - Δ ADC is a result of the full-scale current of the feedback DACs, as well as the conductances (G) and capacitances (C) associated with each resonator. The value of these programmable components are calculated from the user specified application parameters listed in Table 7. The impact of each of these parameters on the performance of the AD6676 is described in subsequent sections.

Table 7. List of User Specified Application Parameters That Determine the Σ - Δ ADC Internal Settings

Application Parameter	Description	SPI Register(s)
FIF	IF center frequency in MHz	0x102, 0x103
BW	IF pass band bandwidth in MHz	0x104, 0x105
F _{ADC}	Σ - Δ ADC clock rate in MHz	0x100, 0x101
L _{EXT}	External inductor value in nH	0x106
MRGN	Margin offset to set resonator frequency in MHz	0x107 to 0x109
IDAC1 _{FS}	Full-scale current of IDAC1 that sets PIN_0DBFS level	0x10A

The on-chip controller is used only during device initialization and performs the following tasks:

- Power-up negative regulator (used by IDACs)
- Calibrate RESON1 and 17-level flash ADC
- Tune Σ - Δ ADC based on user input parameters
- Set up PLL used by JESD204B PHY

After device initialization, the on-chip controller is disabled; it is not used during normal device operation.

Signal and Noise Transfer Functions

The frequency domain response of a Σ - Δ ADC is defined by its signal and noise transfer functions (STF and NTF). Figure 69 shows a simplified feedback model of a Σ - Δ modulator with the ADC quantization error modeled as an additive noise source (E) after the loop filter (H). The STF is the frequency response of the output signal (V) relative to a swept single tone at its input (U) while the NTF is the frequency response of the ADC quantization noise (that is, V/E) that undergoes noise shaping due to of the loop filter of the ADC. Note that the ADC and DACs within the feedback loop operate at a much higher clock rate than a traditional open-loop ADC in which only the Nyquist criterion must be satisfied ($F_{ADC} = 2 \times BW$).

The oversampling ratio (OSR) is a key parameter of any Σ - Δ ADC and is defined as follows:

$$OSR = F_{ADC} / (2 \times BW) \quad (1)$$

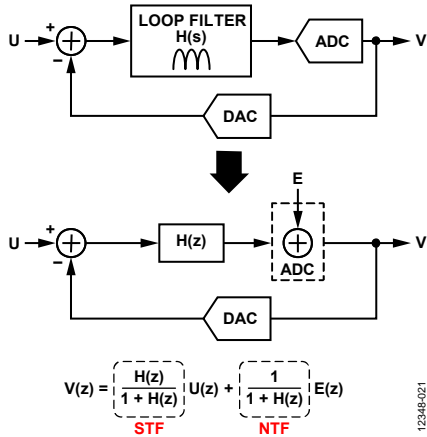

Figure 69. Simplified Model of a Σ-Δ ADC Showing Origins of STF and NTF

In the case of the AD6676, the loop filter consists of three cascaded resonators to implement a sixth-order band-pass response, thus allowing the oversampling ratio of the AD6676 to be kept to moderate levels (≥ 10) such that useable bandwidths of up to 160 MHz can be realized. The loop filter utilizes a feedback architecture so that the STF has minimal out-of-band gain peaking while the NTF suppresses the in-band quantization noise. Figure 70 shows an example of the STF and the shaped noise of the Σ-Δ ADC when it is configured for BW = 80 MHz, $F_{IF} = 300$ MHz, and $F_{ADC} = 3.2$ GHz. Note that the NSD near F_{IF} is much lower than the NSD elsewhere and that the STF is quite broadband.

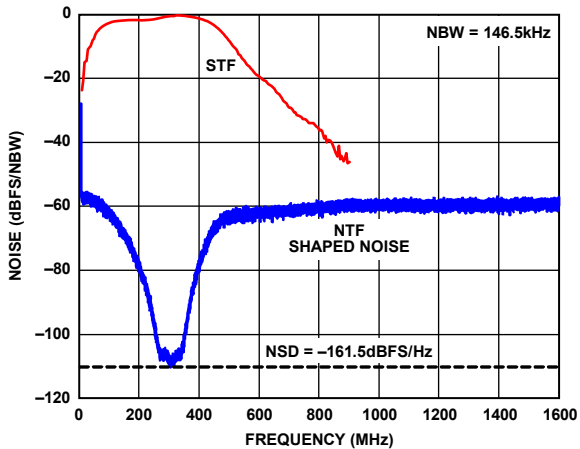

Figure 70. STF and NTF Shaped Noise of the Σ-Δ ADC ($F_{IF} = 300$ MHz, BW = 80 MHz, $F_{ADC} = 3.2$ GHz, $L_{EXT} = 19$ nH)

Figure 71 focuses on the IF pass band region to compare the measured vs. ideal shaped noise with the theoretical NSD curve accounting only for the ideal ADC quantization effect. The resonator zero locations are highlighted on the theoretical trace and are recognizable in the measured response. Note that the region with the lowest NSD performance or the deepest notch is always centered about the F_{IF} setting. This is because the gain of RESON1 peaks at F_{IF} and the noise from stages which follow RESON1 is input referred by dividing by the gain of RESON1.

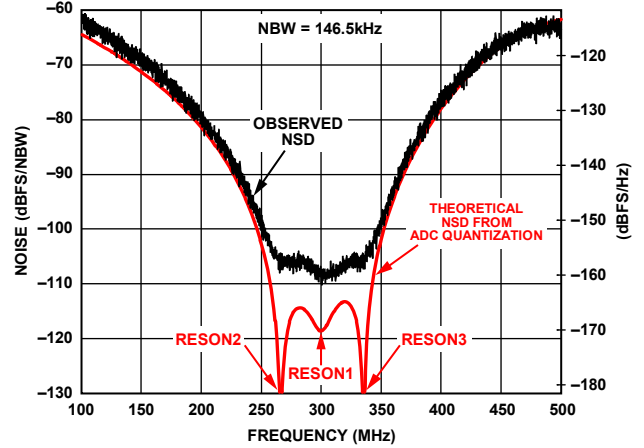

Figure 71. Measured vs. Ideal NTF ($F_{IF} = 300$ MHz, BW = 80 MHz, $F_{ADC} = 3.2$ GHz, $L_{EXT} = 19$ nH)

Unlike conventional ADCs, the NSD of a Σ-Δ ADC is not flat due to its frequency dependent loop filter, $H(s)$, which shapes the quantization noise as well as various other noise sources. Because the Σ-Δ ADC is highly programmable, its NSD can be optimized for the user specified application parameter settings. In general, the NSD performance varies based on the application parameter settings in the following ways:

- Operating with a high oversampling ratio (OSR > 20) results in the lowest and flattest NSD performance. This is because the resonant frequencies (or zero locations) associated with RESON1, RESON2, and RESON3 are close together when the oversampling ratio is high thereby reducing the quantization noise to the point where thermal noise from the first stage IDAC1 dominates.
- Operating at reduced oversampling ratio (oversampling ratio < 20) causes the quantization noise contribution to become more significant, causing humps to appear in the NSD. Bumpiness in the NSD occurs because the resonant frequencies associated RESON2 and RESON3 are further offset from RESON1 to accommodate the increase in BW; therefore, resulting in less overall loop gain to suppress this increasingly dominant noise source. The effect of different oversampling ratios on the NSD is shown in Figure 72.
- Operating at a lower F_{IF} while keeping the same oversampling ratio results in degraded NSD performance at the pass band edges, as shown in Figure 73.

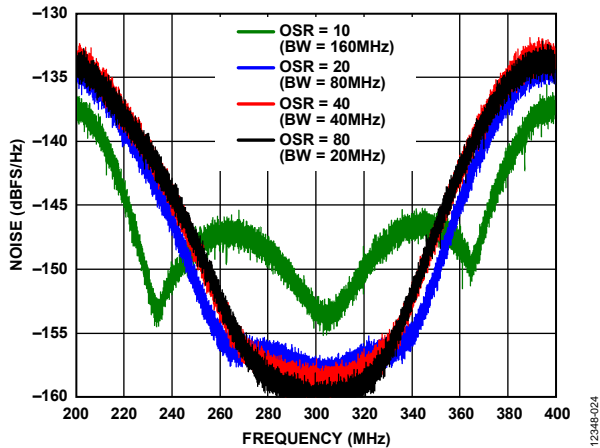

Figure 72. NSD vs. Oversampling Ratio ($F_{IF} = 300$ MHz, $F_{ADC} = 3.2$ GHz, $L_{EXT} = 19$ nH)

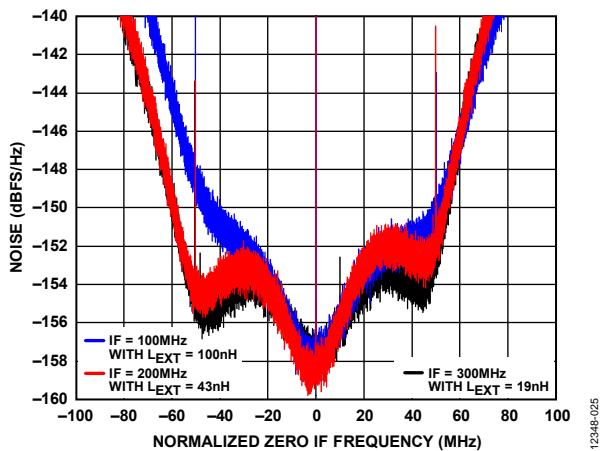

Figure 73. NSD at Pass Band Edge Improvement as F_{IF} Is Increased from 100 MHz to 300 MHz with Fixed Oversampling Ratio = 16 ($BW = 100$ MHz, $F_{ADC} = 3.2$ GHz)

The impact of a uneven NSD profile on a particular application depends on the bandwidth and modulation characteristics of the IF signal being digitized and demodulated. For example, a multimode software defined radio containing narrow-band carriers situated anywhere across the pass band must consider the NSD performance at the highest levels across the pass band because this represents the worst-case NSD when calculating the in-band noise for a narrow-band signal in this region. Conversely, a single wideband QAM signal falling at the center of the IF pass band benefits from excellent in-band noise performance because the NSD remains the lowest in this region. Note that the AD6676 specified NF is measured in the region where its NSD is highest.

STF and NTF Repeatability

After the application parameters have been determined, the STF and NTF characteristics of the AD6676 remain repeatable and stable over temperature and among devices. The on-chip calibration performed during the power-up initialization phase reduces the device-to-device variation that may otherwise exist due to tolerances associated with the device process or the external inductor, L_{EXT} . It is worth noting that that the small variation in STF and NTF that does exist is likely to be less than traditional receiver solutions employing low oversampling ADCs with aggressive high order LC antialiasing filters. L and C component tolerances as well as variation in active device source and load impedances must be considered in the Monte Carlo analysis.

The following application parameters were used to demonstrate STF and NTF repeatability: $f_{CLK} = 3.2$ GHz, $F_{IF} = 250$ MHz, $BW = 75$ MHz, $L_{EXT} = 19$ nH, $IDAC1_{FS} = 4$ mA, $MRGN =$ default. Figure 74 and Figure 75 demonstrate the repeatability and temperature stability of the STF and NTF responses of single devices for five consecutive power-up initialization operations in which the device is calibrated at 25°C and then allowed to drift to -40°C and +85°C.

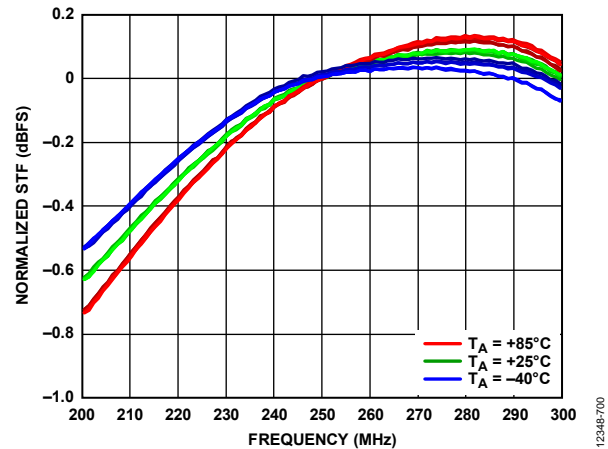

Figure 74. STF Variation over Temperature for a Single Device for Five Consecutive Power-Up Initialization Operations

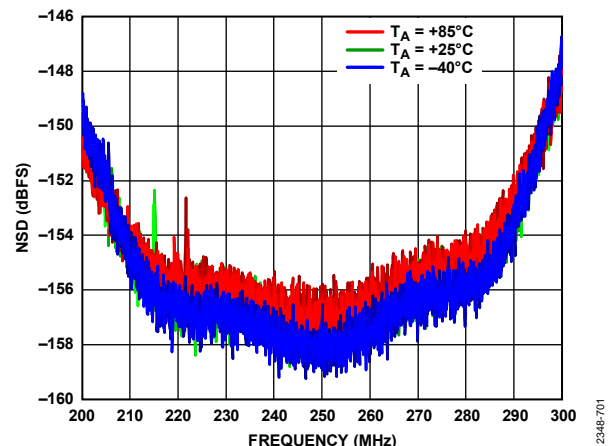

Figure 75. NTF Variation over Temperature for a Single Device for Five Consecutive Power-Up Initialization Operations

Σ - Δ ADC Overload and Recovery

The Σ - Δ ADC is a sixth-order modulator employing negative feedback to reduce the noise contribution of its internal quantizer. Like any ADC, the quantizer is driven into overload under large signal conditions, causing its output to be a poor representation of its input. However, unlike traditional ADCs that operate in open-loop, a Σ - Δ ADC can be driven into overload with signals slightly below its 0 dBFS full-scale input level and the feedback loop can become unstable and may not return to normal operation when the overload condition is removed. A typical unstable Σ - Δ ADC produces a digital output that varies between plus or minus full scale. The AD6676 employs several techniques to solve these problems.

First, to make the no overload range with continuous wave tones approach levels near 0 dBFS, the AD6676 uses a 5-bit quantizer. The AD6676 is specified to remain unconditionally stable for continuous wave levels below -2 dBFS over its full operation range, with a typical overload level of -0.5 dBFS. In practice, the large signal waveform characteristics that determine the occurrence and duration of its peaks affect the overload threshold. A continuous wave tone is close to the worst-case scenario for overload because the peak levels have the highest probability of occurrence. Alternatively, a signal that has a much higher crest factor and a more Gaussian-like histogram is less likely to cause overload due to the short duration of its peak excursions. For this reason, for systems employing AGC, consider the waveform characteristics when setting the AGC threshold.

Second, to ensure that the ADC does not become stuck in a self sustaining overload condition, the AD6676 includes the means to detect overload, reset the Σ - Δ ADC, and quickly return it to normal operation. An overload condition is declared if more than five out of eight samples from the quantizer are equal to a positive or negative full-scale value. After overload is detected, the internal nodes within the Σ - Δ ADC are reset to their zero state and the attenuation setting is temporarily increased by 6 dB. The ADC reset is removed after 16 F_{ADC} clock cycles and over the next 48 F_{ADC} clock cycles, the attenuation is returned to its original value. If the input signal is such that an overload occurs again, this process repeats until the signal falls within the no overload range of the Σ - Δ ADC. Although the Σ - Δ ADC produces good data within 64 F_{ADC} clock cycles of the signal falling within the no overload range, the bad data associated with an overload event must be flushed out of the decimation filters before the output of the AD6676 is completely clean of any memory effects.

Figure 76 to Figure 79 show the measured overload recovery response for each of the decimation filter modes (DEC_MODE) when driven by a periodic pulsed CW waveform of 10 ns duration and 2% duty cycle. The narrow pulse region of the waveform was set to be only 1 dB higher than the other region with its peak power adjusted slightly above the overload threshold level resulting in an occasional overload event.

Each plot compares the envelope response between a pulse that results in an overload event to a pulse where the Σ - Δ ADC remains stable and includes a zoom in region showing settling time to within 1% following the large scale settling plot. Because the phase response recovers two to three samples before the envelope response, the phase response is not shown.

Note the following:

- The AD6676 was configured for $F_{IF} = 300$ MHz, $BW = 100$ MHz, and $F_{ADC} = 3.2$ GHz.
- The absolute settling response for any decimation factor scales with f_{DATA_IQ} . For example, the settling time shown in Figure 77 is an additional seven samples at $f_{DATA_IQ} = 200$ MSPS, thus the absolute settling time is 35 ns ($7 \times 1/200$ MSPS).
- Selecting a decimation factor of 12 or 16 improves the absolute settling time because it reduces the additive delay caused by the last stage decimation filter.

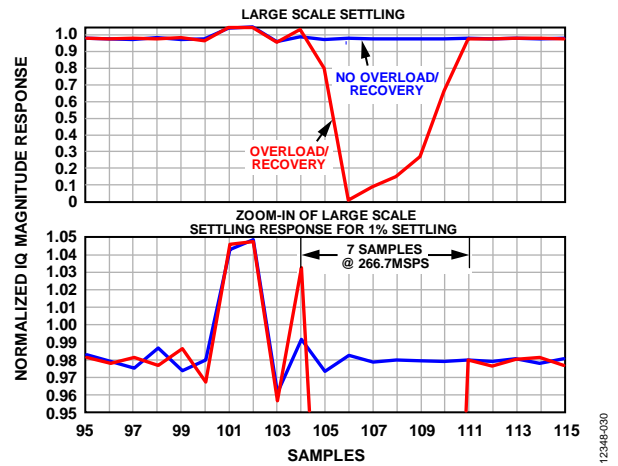

Figure 76. Comparison of Normalized IQ Magnitude Response for Decimate by 12 Case When a Pulsed CW Waveform (10 ns Width) Is Just Below and Above Peak Power Level, Resulting in ADC Overload

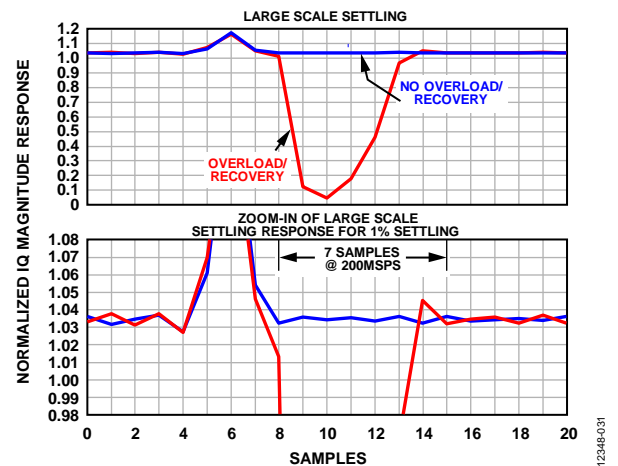

Figure 77. Comparison of Normalized IQ Magnitude Response for Decimate by 16 Case When a Pulsed CW Waveform (10 ns Width) Is Just Below and Above Peak Power Level, Resulting in ADC Overload

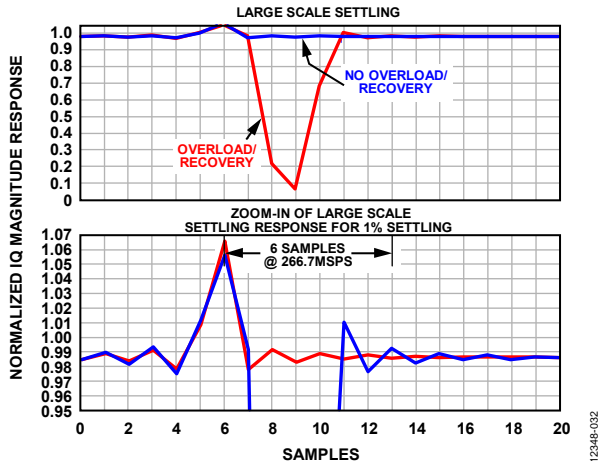

Figure 78. Comparison of Normalized IQ Magnitude Response for Decimate by 24 Case When a Pulsed CW Waveform (10 ns Width) Is Just Below and Above Peak Power Level, Resulting in ADC Overload

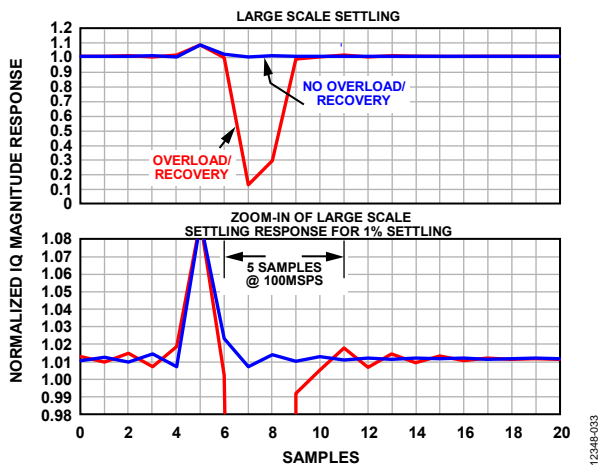

Figure 79. Comparison of Normalized IQ Magnitude Response for Decimate by 32 Case When a Pulsed CW Waveform (10 ns Width) Is Just Below and Above Peak Power Level, Resulting in ADC Overload

Σ-Δ ADC CONFIGURATION CONSIDERATIONS

Maximum Input Power (PIN_0dBFS and IDAC1FS)

The AD6676 maximum full-scale input power (PIN_0dBFS) for a sinusoidal input signal is dependent on the IDAC1 peak full-scale output current (IDAC1FS) and the RIN of the attenuator (that is, 60 Ω) as shown in the equation below.

$$PIN_{0dBFS} = 10 \times \log_{10}(1/2 \times R_{IN} \times IDAC1_{FS}^2) \quad (2)$$

The derivation of this equation becomes apparent when considering the AD6676 input stage consisting of RESON1, IDAC1, and RIN, as shown in Figure 68. RIN is the input resistance of the attenuator. The cascode transistor associated with IDAC1 and RIN establishes a low impedance node serving as a current mode summing junction whereby the input signal (equal to VIN±/RIN) is compared to the feedback signal from IDAC1. Note that the feedback loop of the Σ-Δ modulator attempts to generate an equal but opposite feedback current to cancel the signal current appearing at this summing junction.

Ultimately, the maximum feedback signal current that can be generated by IDAC1 is limited by its full-scale setting, IDAC1FS, thus setting the 0 dBFS level on which feedback can no longer cancel any further increase in input signal level (or power). For example, the AD6676 nominal setting for IDAC1FS at 4 mA equates to a PIN_0dBFS of -3 dBm, resulting in a differential voltage swing of ±240 mV peak.

Equation 2 assumes that the attenuator setting is 0 dB. Any setting beyond 0 dB increases the effective PIN_0dBFS measured at the input of the attenuator by an amount equal to the attenuator setting.

In practice, the actual measured PIN_0dBFS may vary a few tenths of a decibel for different application parameter settings due to some amount of pass band tilt. For this reason, PIN_0dBFS is defined at the IF center.

L_{EXT} Selection

The range of permissible values for L_{EXT} depends on the following application parameters: FIF, FADC, and IDAC1FS. Figure 80 shows the upper and lower settings (L_{MAX} and L_{MIN}) when IDAC1FS is set to its default settings of 4 mA. Note that the L_{MAX} limit is set by the largest voltage swing across the LC tank and the L_{MIN} limit is set by the maximum tuning capacitance available from an internal capacitor array.

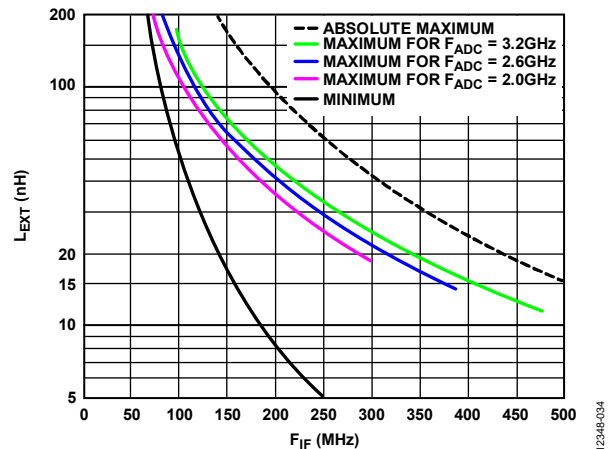

Figure 80. Maximum External Inductor Value as a Function of IF Frequency and Clock Rate for IDAC1FS = 4 mA

Note the following points when selecting L_{EXT}:

- Larger values of L_{EXT} result in larger voltage swings across the LC tank. Selecting a value that is approximately 55% to 80% of the L_{MAX} value can be considered with a lower value, typically resulting in improved IMD performance due to reduced voltage swing across the inductor. Conversely, a higher value may lead to a slight improvement in noise performance (mostly near the IF center), but at the expense of IMD performance.
- Inductor accuracy of 10% is sufficient because it falls well within the calibration range of the AD6676 during its initialization phase on power-up.

- Surface mount inductors can be either wire-wound or multilayer. The lower cost multilayer inductors typically have quality factors below 20 that may have a slight impact on the AD6676 NSD performance. Compare performance between the two inductor types before making a decision to select a lower cost multilayer type.
- Because the voltage swing across the LC tank scales proportionally with $IDAC1_{FS}$, which sets PIN_0dBFS , a reduction in $IDAC1_{FS}$ allows an inversely proportional increase of L_{EXT} to maintain a similar voltage swing. Note that the minimum tuning capacitance from the internal capacitor array along with any parasitic PCB capacitance sets largest the L_{EXT} as defined in Equation 3.

$$L_{MAX_TUNE} = ((2\pi \times F_{IF})^2 \times 7.1 \text{ pF})^{-1} \quad (3)$$

The minimum capacitance contribution of the array can be up to 6.6 pF due to ± 20 process variation. An additional 0.5 pF of PCB parasitic capacitance is also included, thus a value of 7.1 pF is used.

Tie the two external inductors, L_{EXT} , to the VDD2 supply via a 10 Ω resistor that includes a 0.1 μF decoupling capacitor, as shown in Figure 93.

The following example highlights how L_{EXT} can be determined with the following application parameters: $F_{IF} = 150 \text{ MHz}$, $F_{ADC} = 3.0 \text{ GHz}$ and $IDAC1_{FS} = 4 \text{ mA}$. Referring to Figure 80, the L_{MAX} and L_{MIN} range is from 20 nH to 70 nH. A value of 43 nH represents 61% of L_{MAX} and thus is suitable. Note that if the $IDAC1_{FS}$ is reduced to 2 mA, this value can be increased to 86 nH because this value is below the absolute maximum.

Reduced PIN_0dBFS Operation via Scaling $IDAC1_{FS}$

The PIN_0dBFS can be reduced by up to 12 dB because $IDAC1_{FS}$ is adjustable over a 4 mA to 1 mA span as defined by Equation 4.

$$IDAC1_{FS} = 4 \text{ mA} \times (IDAC1_FS/64) \quad (4)$$

where $IDAC1_FS$ is the decimal equivalent of the value in Register 0x10A.

The L_{EXT} value can be increased proportionally to any reduction in $IDAC1_{FS}$ to maintain similar voltage swings across the LC tank.

The NSD and IMD performance are shown in Figure 81 and Figure 82 for $IDAC1_{FS}$ settings of 4.0 mA, 2.0 mA, and 1.0 mA. Figure 83 shows the STF response for each of these cases. Note the following observations from this example:

- With an IF of 300 MHz, the absolute maximum inductor is 39 nH; therefore, this inductor value is selected for both $IDAC1_{FS} = 2.0 \text{ mA}$ and 1.0 mA .
- Reducing $IDAC1_{FS}$ from 4.0 mA to 2.0 mA and doubling L_{EXT} lowers the PIN_0dBFS by 6 dB but increases the average in-band noise, IBN, by only 1.8 dB. The noise figure of the ADC therefore improves by 4.2 dB.
- Reducing $IDAC1_{FS}$ from 2.0 mA to 1.0 mA lowers the ADC full scale by a further 6 dB and increases the average in-band noise by only 4.6 dB. In this case, the noise figure improvement is a modest 1.4 dB.

- The swept IMD performance shows a degradation at reduced $IDAC1_{FS}$ settings.
- The STF response remains largely unaffected by reduced $IDAC1_{FS}$ settings.

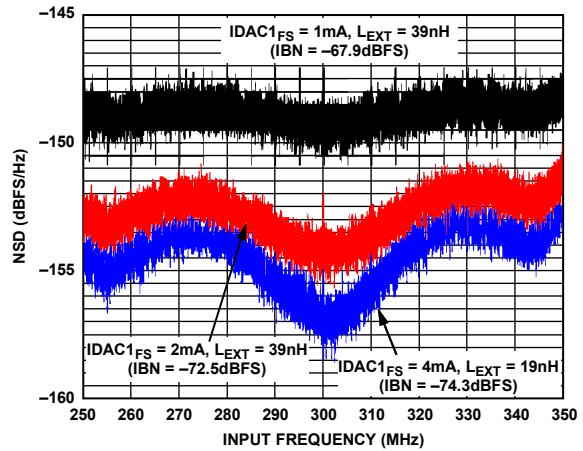

Figure 81. NSD vs. $IDAC1_{FS}$ Setting with Decimate by 16, I/Q Output ($IF = 300 \text{ MHz}$, $BW = 100 \text{ MHz}$, $F_{ADC} = 3.2 \text{ GHz}$)

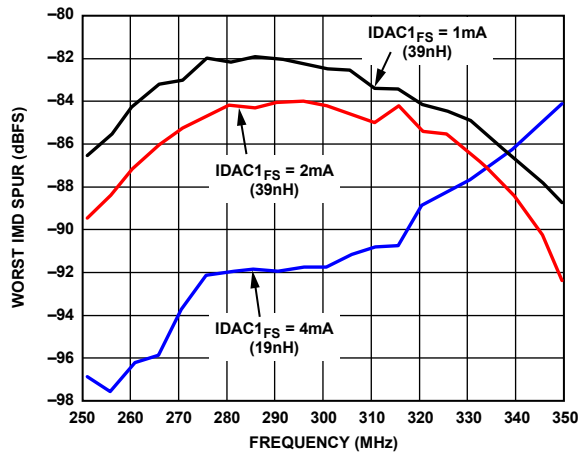

Figure 82. Swept Dual-Tone IMD vs. $IDAC1_{FS}$ Setting with Decimate by 16, I/Q Output, Dual Tones Set to -8 dBFS ($IF = 300 \text{ MHz}$, $BW = 100 \text{ MHz}$, $F_{ADC} = 3.2 \text{ GHz}$)

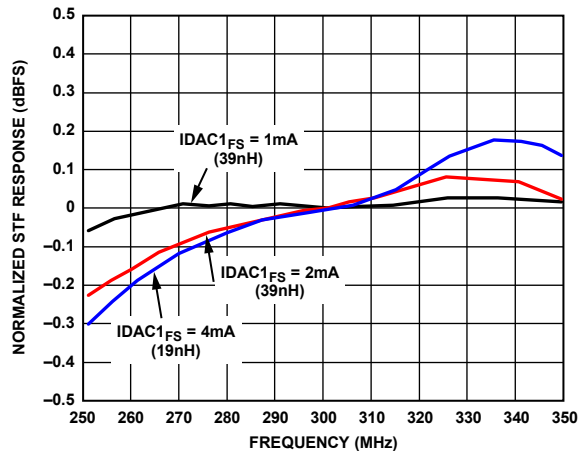

Figure 83. STF vs. $IDAC1_{FS}$ Setting with Decimate by 16, I/Q Output, Dual Tones Set to -8 dBFS ($IF = 300 \text{ MHz}$, $BW = 100 \text{ MHz}$, $F_{ADC} = 3.2 \text{ GHz}$)

Some applications may benefit from a reduced $IDAC1_{FS}$ setting because a reduction in the PIN_{0dBFS} levels results in a decibel per decibel reduction in the gain and linearity (P1dB, IIP3) requirements of the front-end driver. This enables a lower power RF line-up with the possibility of 3.3 V operations. Alternatively, it can allow a greater IF AGC operation range from the AD6676 when the previous stages output (P1dB) level is set by its power supply setting. Carefully evaluate the trade-off in the ac performance of the AD6676 when deciding to operate at reduced $IDAC1_{FS}$ settings.

Using the MRGN Parameter to Optimize NTF

The MRGN application parameters provide an additional degree of freedom when trying to optimize the NTF for a particular application. This feature is particularly useful when the AD6676 operates with a low oversampling ratio where the quantization noise contribution begins to limit the NSD performance. In such cases, the default MRGN settings may not be adequate, resulting in regions of the pass band (typically at the edges) where the worst-case NSD is higher than in other regions. For these cases, the NTF can be optimized by adjusting the Σ - Δ ADC resonator frequencies in such a way that that result in a more optimally distributed NSD over the entire pass band.

The MRGN_L, MRGN_U, and MRGN_IF parameters are located in Register 0x107 through Register 0x109. MRGN_L and MRGN_U specify the number of megahertz by which the lower and upper edges of the target pass band are extended, whereas MRGN_IF specifies the resonance frequency offset of RESON1 from the center of the target pass band. The maximum setting in these registers must be in the range of 10 MHz to 20 MHz because higher offset settings can adversely affect the STF. The MRGN parameter is represented as an array equal to [MRGN_L, MRGN_U, MRGN_IF].

The following example using a low oversampling ratio of 10 highlights the effects of the MRGN parameters on the NTF and STF. In this example, the goal is to optimize the worst-case NSD performance across a 160 MHz pass band region with $F_{ADC} = 3.2$ GHz and $IF = 300$ MHz while trying to preserve a flat STF. Figure 84 shows the corresponding NTF performance for different MRGN settings, and Table 8 lists the resonant frequencies of RESON1, RESON2, and RESON3 that pertain to these settings. Note that the default setting of [5 5 0] results in the upper half of the pass band having the worst NSD (-141 dBFS/Hz at 380 MHz). Symmetrical MRGN settings of [10 10 0] and [15 15 0] are shown to highlight how the NTF varies as only the resonant frequencies of RESON2 and RESON3 are increasingly offset symmetrically about the IF center of 300 MHz. To improve on the default setting of [5 5 0], an asymmetrical setting of [8 16 2] that is weighted towards the upper half of the pass band region was found to achieve a more distributed worst-case NSD of -145 dBFS/Hz.

Table 8. Resonator Frequencies vs. MRGN Settings
($F_{ADC} = 3.2$ GHz, $F_{IF} = 300$ MHz, $BW = 160$ MHz)

MRGN_L	MRGN_U	MRGN_IF	RESON2 (MHz)	RESON1 (MHz)	RESON3 (MHz)
5	5	0	233	298	365
10	10	0	229	299	370
15	15	0	227	298	373
8	16	2	230	306	374

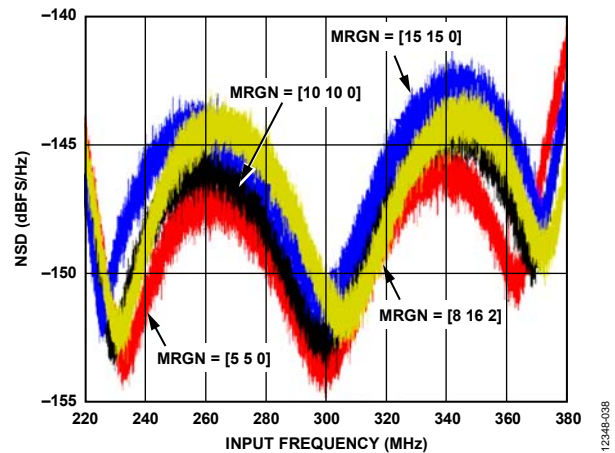

Figure 84. NSD Performance for MRGN Settings Shown in Table 8

Maintaining a flat STF across the pass band is also desirable when modifying the MRGN settings. Figure 84 shows how each of the different MRGN settings affects the STF. Note that the asymmetrical MRGN setting of [8 16 2] results in an STF that is slightly skewed above IF center but still maintains ± 0.5 dB flatness.

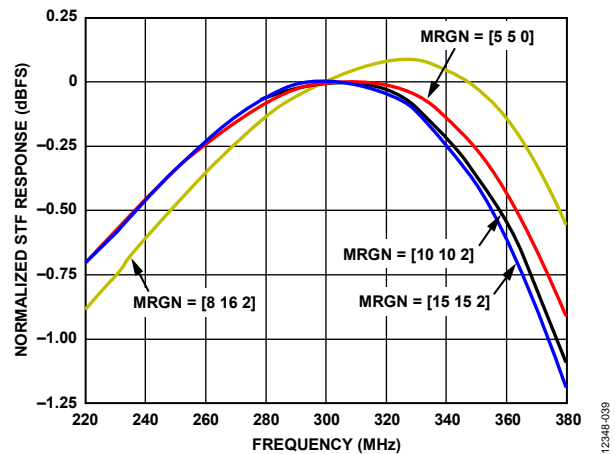

Figure 85. STF for Four Different MRGN Settings

Whereas the previous example represents an extreme case, other cases having higher oversampling ratio can also potentially benefit from optimization. After the values of f_{CLK} , IF , and BW have been determined for a particular application, it may be advantageous to explore whether a different MRGN setting yields any improvement. It is important to note that this sort of optimization is based on an iterative trial and error method. However, after the MRGN setting has been determined, both the STF and NTF remain repeatable.

Σ-Δ ADC Adaptive Shuffler

The AD6676 includes a programmable adaptive shuffler that improves the SFDR and IMD performance of the Σ-Δ ADC under large signal conditions. As shown in Figure 68, the adaptive shuffler randomizes the selection of the unit elements used by the feedback DACs to reconstruct the output signal of the quantizer. Both static and dynamic mismatch errors associated with the quantizer and feedback DACs are dithered such that the spurious contribution is spread across a wider frequency span. Figure 86 compares the improved IMD performance for a two tone excitation when the shuffler is enabled and disabled.

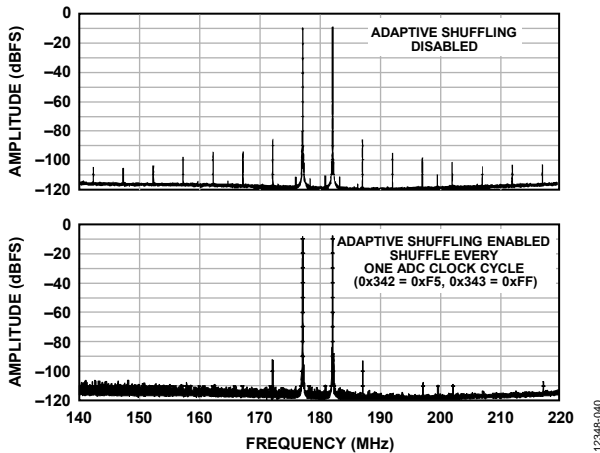

Figure 86. IMD Performance when Shuffler Is Disabled vs. Enabled for Two CW Tones at -8 dBFS, ($F_{IF} = 180\text{ MHz}$, $BW = 80\text{ MHz}$, $F_{ADC} = 3.2\text{ GHz}$, $L_{EXT} = 43\text{ nH}$)

Although the shuffler improves the SFDR and IMD performance, it does so at the expense of the in-band NSD performance. For this reason, both the degree of shuffling as well as the enabling threshold relative to the quantizer output code is user programmable, allowing optimization for a target application. The shuffling rate is variable from 1 to 4 ADC clock cycles ($1/F_{ADC}$). The shuffler remains enabled for a fixed amount of clock cycles from the instant that the input signal falls below this threshold and remains below it.

The enabling threshold is relative to the quantizer code and represents the peak absolute value that triggers the shuffler. The quantizer can produce an output code ranging from -8 to +8, therefore the threshold can assume a value between 0 to 8. The 4-bit value is set via Register 0x342 or Register 0x343. A hexadecimal value of 0x0 sets the shuffler to always enabled whereas a value of 0xF effectively disables the shuffler.

The 4-bit fields in Register 0x342 and Register 0x343 set the threshold value based on the shuffling rate selected. Set only the 4-bit field pertaining to the selected shuffling rate while the remaining nonapplicable 4-bit fields set to 0xF. Disable the shuffler by setting all the 4-bit fields to 0xF, the highest threshold setting. Table 9 shows the SPI register settings for the various shuffling modes when the threshold is set to its default setting of 5. Other threshold values ranging from 3 to 8 are also possible. Table 10 shows the input power level that triggers the shuffler for different threshold value settings when driven by a continuous wave tone.

Table 9. Default SPI Register Settings for Adaptive Shuffling

Shuffling Rate	Register 0x342	Register 0x343
F_{ADC}	0xF5	0xFF
$F_{ADC}/2$	0x5F	0xFF
$F_{ADC}/3$	0xFF	0xF5
$F_{ADC}/4$	0xFF	0x5F
Disable shuffler	0xFF	0xFF

Table 10. Threshold Setting Values that Trigger the Shuffler for a Continuous Wave Tone

P_{IN} (dBFS)	Threshold Setting
-3	8
-5	7
-7	6
-10	5
-14	4
-20	3

When enabled, the shuffler can introduce colored noise into the pass band spectrum. This additional noise is a result of the increased switching activity within the Σ-Δ ADC core along with the pseudorandom element selection process, thus resulting in signal level dependent colored noise at frequency offsets related to the shuffling rate. Figure 87 highlights the effect of the colored noise between shuffle every four clock cycles vs. one cycle with and without a large signal continuous wave tone present and the shuffling threshold set to 0.

Typically, the shuffling threshold is set in the range of 4 to 6. This example serves to highlight the colored noise effects of shuffling. Selecting a higher threshold setting is preferable when trying to preserve the NSD performance. For this reason, the AD6676 default threshold setting is 5 with the shuffle every clock cycle option.

The four-cycle option introduces visible noise humps with a -1 dBFS signal level. This colored noise is at an offset of $f_{CLK}/128$, resulting from the pseudorandom element selection process. Other shuffling options also introduce colored noise but at a greater frequency offset that are related to the shuffling rate factor (SRF) as described by the following equation:

$$Frequency\ Offset = f_{CLK}/(32 \times SRF) \tag{5}$$

The effect of this colored noise is worthy of consideration when selecting the shuffling rate and threshold. For example, sweeping a -1 dBFS continuous wave tone across the usable IF pass band region while monitoring the NSD characteristics is helpful to identify what shuffling rate may have the least impact on the NSD performance.

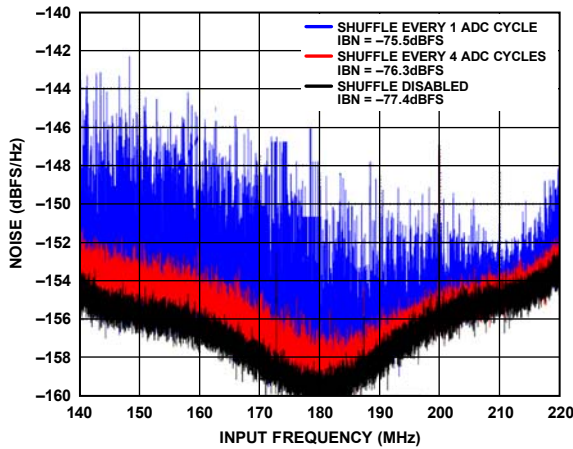

Figure 87. NSD Performance of the Various Shuffling Settings with No Signal; Threshold Set to 0 (Shuffler Is Always Enabled); $F_{IF} = 180$ MHz, $BW = 80$ MHz, $F_{ADC} = 3.2$ GHz, $L_{EXT} = 43$ nH

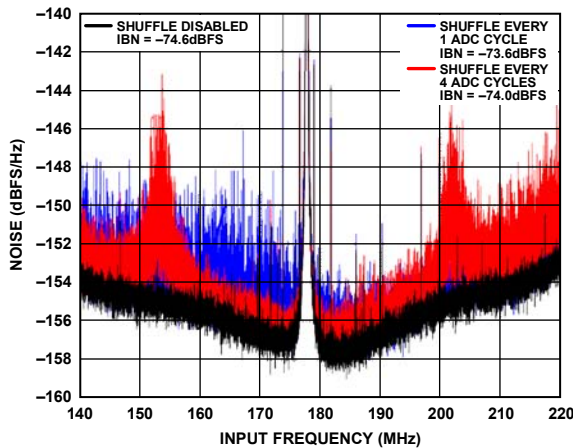

Figure 88. NSD Performance of the Various Shuffling Settings with a -1 dBFS Signal; Threshold Set to 0 (Shuffler Is Always Enabled); $F_{IF} = 180$ MHz, $BW = 80$ MHz, $F_{ADC} = 3.2$ GHz, $L_{EXT} = 43$ nH

The degradation in NSD performance is also dependent on the input signals amplitude; thus, it is important to select a shuffling rate and threshold setting that result in an optimum trade-off between large signal linearity performance and low signal level in-band noise performance. Figure 89 shows how the in-band noise (dBFS) degrades at increasing signal levels for the same settings used in Figure 87. In this example, a continuous wave tone is placed just above the pass band with its power swept from -40 dBFS to -1 dBFS. At low signal levels (less than -20 dBFS), the degradation in in-band noise performance is dependent on the shuffling rate. At higher signal levels (greater than -20 dBFS), the degradation is a result of increased colored noise falling in the pass band. Selecting a shuffle rate of every two ADC cycles with a threshold in the range of 4 or 5 is a good compromise, as shown in Figure 90.

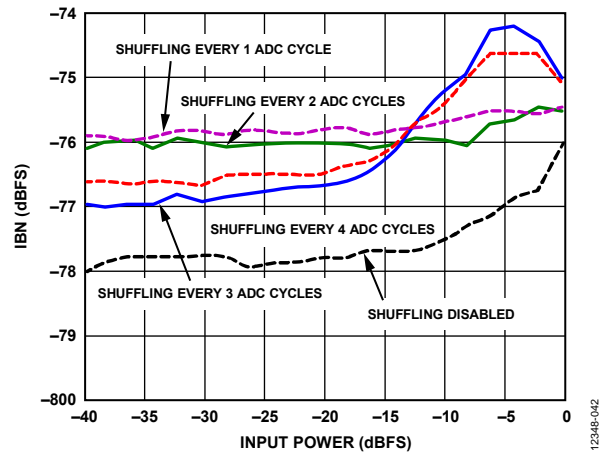

Figure 89. Pass Band Degradation in IBN (dBFS) as a Continuous Wave Tone at 225 MHz, Swept from -40 dBFS to -1 dBFS with Different Shuffling Rate Settings, Threshold Set to 0, $F_{IF} = 180$ MHz, $BW = 80$ MHz, $F_{ADC} = 3.2$ GHz, $L_{EXT} = 43$ nH

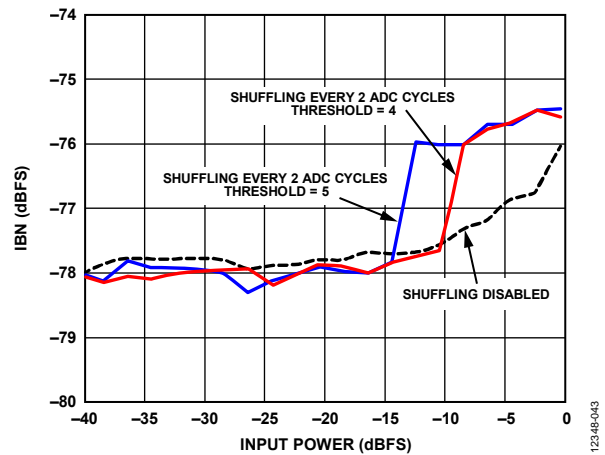

Figure 90. IBN vs. Input Power Performance for Threshold Settings of 4 and 5 When Configured for Shuffle Every Two ADC Cycles

After a particular shuffling configuration is selected, the effects on the Σ - Δ ADC performance remain repeatable over time and among different devices

Σ - Δ ADC Profile Feature

The AD6676 includes a feature that allows the Σ - Δ ADC to store up to four different profile settings that can be recalled quickly via Register 0x118 without recalibrating the Σ - Δ ADC. Calibration of each of the different profiles specified in Register 0x115 occurs during the device initialization phase with each profile consisting of the following various application parameters: BW , F_{IF} , $IDAC1_{FS}$, and $MRGN$. F_{ADC} , along with the decimation filter and JESD204B settings, remains common to ensure that the JESD204B link is maintained when switching between profile settings. Note that the Σ - Δ ADC is operational with the updated profile settings within $1 \mu s$ upon receipt of the SPI command.

The following example highlights how this feature is used for applications that require wide bandwidth capability but not necessarily instantaneous bandwidth. In these applications, it may be possible to divide the required IF bandwidth into narrow subbands where the Σ - Δ ADC can provide higher dynamic range. For instance, in an application that requires 120 MHz of IF bandwidth, consider dividing this bandwidth into three contiguous blocks of 40 MHz, with each IF being offset by 40 MHz. Figure 91 shows that the worst-case NSD is limited to -149 dBFS/Hz when the AD6676 is configured for the wider bandwidth of 120 MHz. Figure 92 shows how the NSD performance is improved by 10 dB when the 120 MHz bandwidth is subdivided into three 40 MHz bands.

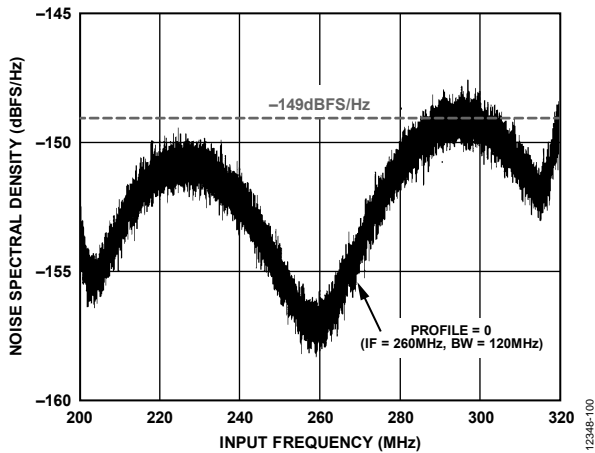

Figure 91. NSD Performance with Wideband Profile ($F_{IF} = 260$ MHz, $BW = 120$ MHz, $F_{ADC} = 3.2$ GHz, $L_{EXT} = 27$ nH)

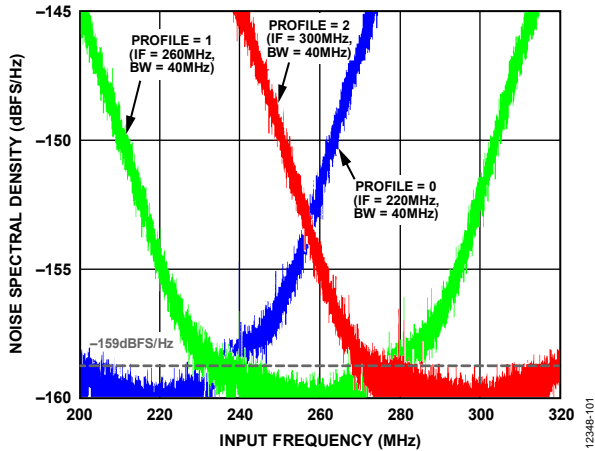

Figure 92. NSD Performance with Narrow-Band Profiles ($F_{IF} = 220$ MHz, 260 MHz, and 300 MHz, $BW = 120$ MHz, $F_{ADC} = 3.2$ GHz, $L_{EXT} = 27$ nH)

In this example, the frequency and phase settings of the digital mixer remained common among the various profiles such that it remained centered upon 260 MHz. It is also possible to provide a unique digital mixer setting for each profile if it is desirable to re-center the digital IF frequency. This feature is desirable in instances where the range of IFs cannot be supported by the pass band response of the digital decimation filter.

ATTENUATOR

The AD6676 includes an on-chip differential 27 dB attenuator with a resolution of 1 dB. The attenuator can be used to rescale the full-scale input level into the ADC for system calibration or for optimization purposes or to prevent possible overload of the Σ - Δ ADC when used with external AGC control. Figure 93 shows a simplified equivalent circuit of the AD6676 input stage, which includes RESON1 and IDAC1. The attenuator provides a nominal input resistance (R_{IN}) of 60Ω to the signal source to facilitate its interface to external driver circuitry. The attenuator is configurable via Register 0x181 to Register 0x183 and includes options for fast external gain control via the AGC pins. Note that the latency from when an external CMOS signal is applied to the AGC pins to when the attenuator changes state is within 5 ns.

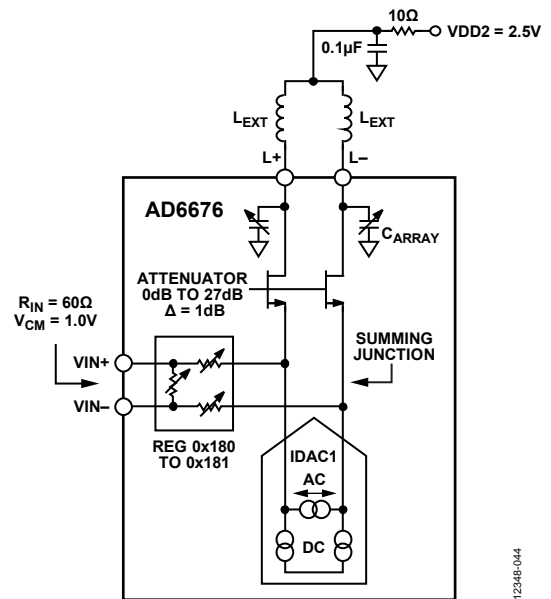

Figure 93. Simplified Equivalent Input

Attenuation is achieved by a programmable shunt and series resistor network that steers some designated amount of input current away from the summing junction while keeping the nominal input resistance near 60Ω over the full attenuation span. For a 0 dB setting, no shunt resistance exists; therefore, all of the input current is fed into the summing junction. For a 6 dB setting, the attenuator is configured with a 120Ω shunt resistor operating in parallel with two 60Ω series resistors such that half of the signal input current is directed into the summing junction while maintaining a nominal 60Ω input resistance. Other settings function in a similar manner with resistor values modified to achieve the desired attenuation value while maintaining the nominal R_{IN} . Figure 94 shows the differential S11 of the AD6676 input for different attenuator settings.

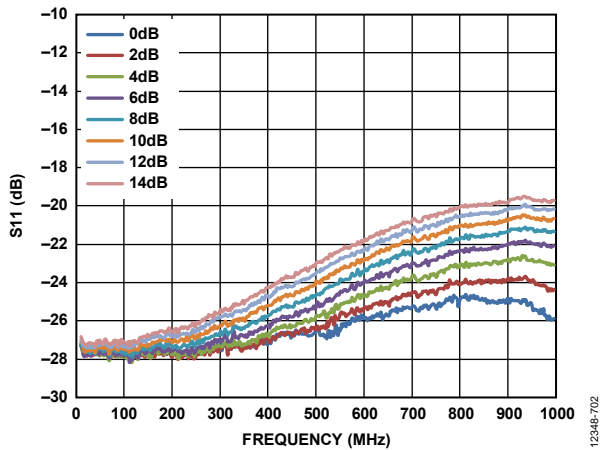

Figure 94. Differential S11 vs. Frequency for Different Attenuator Settings

The accuracy of the attenuator is an important consideration in applications implementing AGC or system calibration. The attenuator remains monotonic over its full operating range. Figure 95, which shows a typical devices attenuation error vs. attenuation state at -40°C , $+25^{\circ}\text{C}$, and $+85^{\circ}\text{C}$, demonstrates the near instrumentation level accuracy of the AD6676 attenuator.

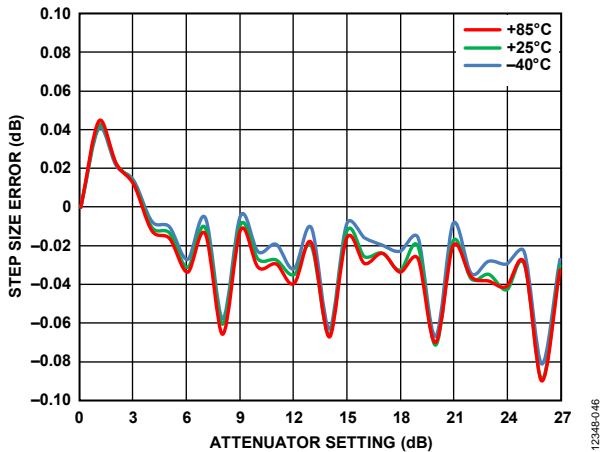

Figure 95. Typical Attenuation Step Size Error vs. Setting over Temperature

The linearity performance of the attenuator is another consideration when determining the largest input drive levels before its nonlinearity may dominate over that of the Σ - Δ ADC. The effective PIN_0dBFS level of the AD6676 is increased decibel-per-decibel by the attenuator setting. At large attenuator settings, the peak-to-peak voltage swing seen at the VIN+ and VIN- pins increases as well as the current that is steered into the attenuator shunt resistance. At a certain level, the IMD contribution from the attenuator begins to dominate over the Σ - Δ ADC contribution. Figure 96 plots the worst third-order IMD spurious vs. attenuator setting for IDAC1FS of 4 mA and 2 mA with the power of the dual tones increased to maintain a constant -8 dBFS level measured by the Σ - Δ ADC. The effective PIN_0dBFS is also plotted to show the maximum continuous wave signal level into the device that results in a 0 dBFS level.

Note the following conditions and observations:

- The AD6676 is configured as follows: IF = 180 MHz, BW = 80 MHz, and $f_{\text{CLK}} = 3.2$ GHz. Tones are situated at 177.5 MHz and 182.5 MHz.
- The PIN_0dBFS level is reduced by 6 dB when IDAC1FS is reduced to 2 mA.
- The IMD performance remains below -80 dBc until an attenuator setting of 9 dB.
- Further increases in the two-tone power lead to a corresponding steady decline in the IMD performance due to the nonlinearity of the attenuator.
- Although not shown, the NSD performance centered about the IF improves a few dB with increased attenuation.

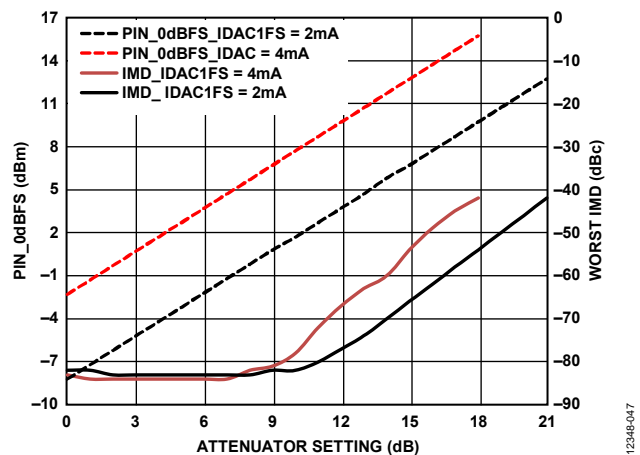

Figure 96. IMD Component Degradation as Two-Tone Centered at an IF of 180 MHz Is Increased 1 dB for Every 1 dB Increase in Attenuator Setting, Such That Two-Tone Level Remains at -8 dBFS

The effects of switching transients are another important consideration for AGC implementations that digitally calibrate gain changes in the signal path of the receiver that can otherwise degrade the demodulation of the desired signals.

Figure 97 and Figure 98 show the IQ envelope response when the attenuator state is switched between 0 dB and 6 dB via an external control signal using the AGC2 input pin at a rate of 3.3 MHz. Note that the settling response is dominated by the response of the digital filter (decimate by 12) and shows no signs of glitch.

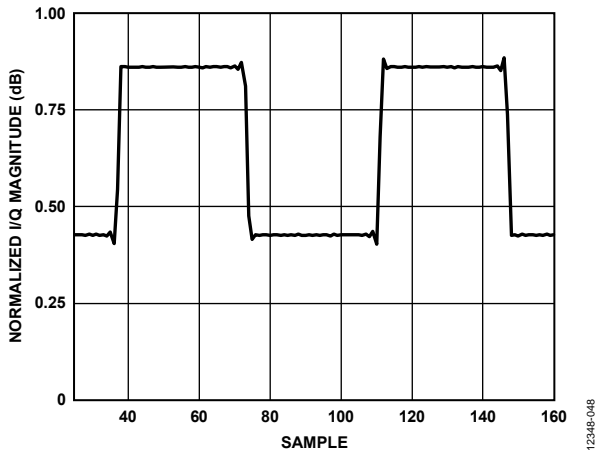

Figure 97. Wide Envelope Response for 6 dB Attenuator Step Change with $f_{DATA_IQ} = 250$ MSPS, Resulting Sample Period of 4 ns

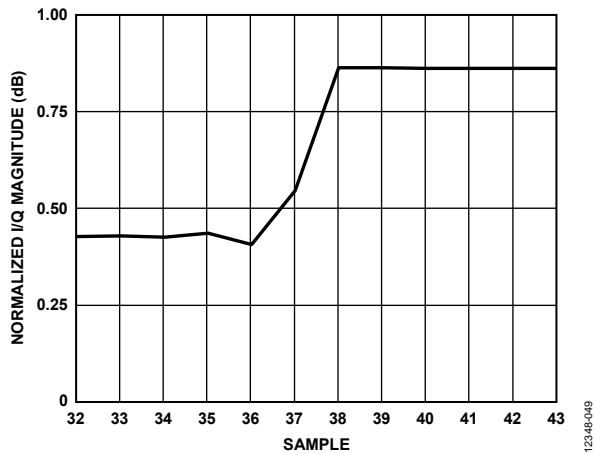

Figure 98. Zoom In Envelope Response for 6 dB Attenuator Step Change with $f_{DATA_IQ} = 250$ MSPS, Resulting Sample Period of 4 ns

CLOCK SYNTHESIZER

The AD6676 includes an on-chip clock synthesizer capable of generating the clock for the Σ - Δ ADC and digital circuitry. The entire synthesizer is integrated on-chip, including the loop filter and VCO. Figure 99 shows a functional block diagram of the various synthesizer subblocks along with the relevant SPI registers. The clock synthesizer uses a standard integer-N architecture to generate a 2.94 GHz to 3.2 GHz ADC clock from a 10 MHz to 320 MHz reference input.

Configuring the clock synthesizer requires numerous SPI commands to program settings and to initiate calibrations. The SPI sequence to configure the AD6676 for a particular operating mode, including the SPI operations associated with the clock synthesizer, is most easily obtained from the software tool that comes with the AD6676EBZ development platform. This tool allows the SPI sequence used to configure the AD6676 to be saved to a file for later use.

Note that if the clock synthesizer is used to supply the ADC clock, the clock synthesizer must be configured first, before any other blocks are enabled. Also note that because the clock synthesizer sequence involves calibrations, wait intervals or polling loops are needed to ensure that each calibration step completes before issuing the next SPI command. Table 27 lists an example SPI sequence for a particular case where the reference frequency (f_{CLK}) and ADC clock rate (F_{ADC}) are 200 MHz and $F_{ADC} = 3200$ MHz, respectively. The remainder of this section describes the configuration of the clock synthesizer in detail.

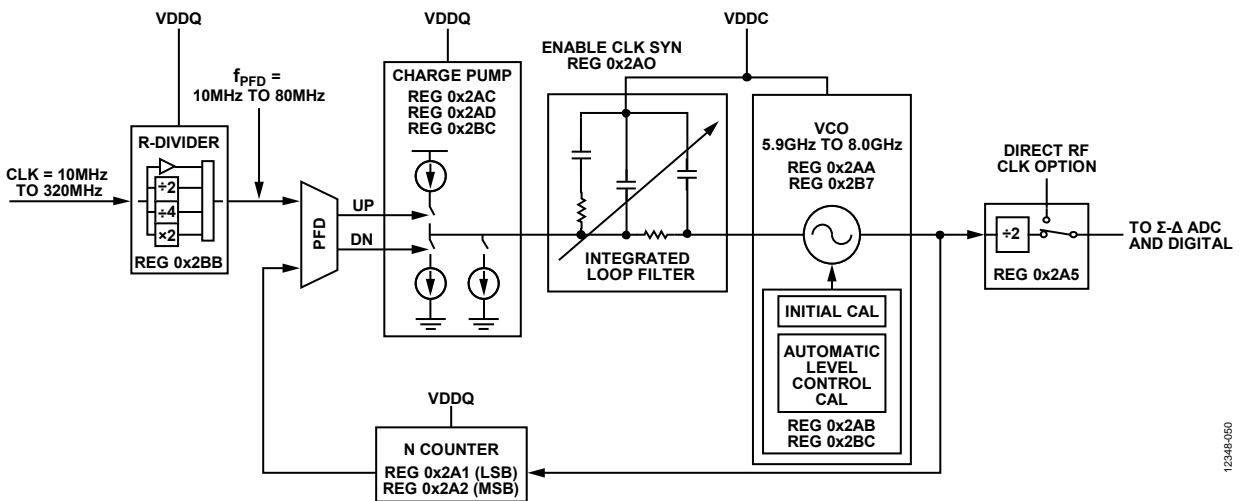

Figure 99. CLK Synthesizer Block Diagram

R and N Dividers

The phase/frequency detector (PFD) requires a 10 MHz to 80 MHz clock. When $f_{CLK} = 200$ MHz, the R divider must be set to divide by 4 so that $f_{PFD} = f_{CLK}/R_{DIV} = 50$ MHz, which is within the supported range. Table 11 shows the mapping from R_{DIV} to the value of Register 0x2BB. This register is set in Step 6 of Table 27.

Table 11. R Divider Settings for Register 0x2BB

R _{DIV}	Register 0x2BB [7:6]
1	0b00
2	0b01
4	0b10
0.5	0b11

Note that operating with the highest permissible f_{PFD} minimizes the clock synthesizer reference spur because the PLL filter bandwidth is fixed at 200 kHz. For a sinusoidal clock input signal that has a limited input slew rate, operation with an input frequency that is $2\times$ or $4\times$ the desired f_{PFD} can also result in a slight improvement in phase noise performance.

Because the ADC clock is obtained by dividing the VCO clock by 2, the N-divider must be set according to

$$N = 2F_{ADC}/f_{PFD} = 2 \times 3.2 \text{ GHz}/50 \text{ MHz} = 128 = 0x80$$

The value of N is programmed by writing the LSB (0x80) to Register 0x2A1 and the MSB (0x00) to Register 0x2A2 and is set in Step 1 of Table 27.

Charge Pump Current and Calibration

The charge pump current setting (Register 0x2AC) is given by

$$I_{CP} = \text{round}\left(\min\left(63, \frac{1.33 \times 10^{28}}{f_{PFD} \times F_{ADC}^2} - 1\right)\right) \quad (6)$$

For the F_{ADC} and f_{PFD} values used in this example, ICP evaluates to 25, or 0x19; this value is programmed in Step 4 of Table 27.

The charge pump also must be calibrated during the clock synthesizer initialization phase. Calibration is triggered via Register 0x2AD. The time required to complete the calibration is inversely proportional to the PFD frequency. For example, using $f_{PFD} = 10$ MHz requires a maximum 4 ms wait period but increasing f_{PFD} to 80 MHz decreases the maximum wait period by a factor of 8 to 0.5 ms. Alternatively, poll Bit 0 of Register 0x2BC; charge pump calibration is complete when this bit is set.

VCO Configuration and Calibration

VCO configuration consists of writing to the SPI registers in Table 12 that control the VCO core bias, temperature compensation, and varactor settings. These settings depend on the VCO frequency and are optimized via characterization to ensure proper operation of the PLL over supply and temperature.

Table 12. VCO Configuration Settings vs. F_{ADC}

F_{ADC} (MHz)	Register 0x2AA	Register 0x2B7
2940 to 2950	0x37	0xF0
2950 to 3100	0x37	0xE0
3100 to 3200 ¹	0x37	0xD0

¹ Operation at 3200 MHz requires the following modification to the KVCO and charge pump resistor settings: Register 0x2A9 = 0x2A and Register 0x2AC = 0x12.

The VCO also must be calibrated during the clock synthesizer initialization phase to ensure proper operation over its full temperature range. VCO calibration is triggered via Register 0x2AB with the amount of time required to complete the calibration again being inversely proportional to the PFD frequency. Specifically, $f_{PFD} = 10$ MHz requires a 2 ms wait period whereas $f_{PFD} = 80$ MHz decreases the wait period by a factor of 8 to 0.25 ms. Alternatively, poll Bit 1 of Register 0x2BC; VCO calibration is complete when this bit is clear.

After the initialization process is complete, verify that Bit 3 of Register 0x2BC is set to confirm that the PLL is locked.

Phase Noise Performance

Above the PLL filter bandwidth of 200 kHz, the internal VCO limits the overall phase noise of the clock synthesizer. The VCO phase noise performance shows a slight improvement at its low end of its F_{ADC} operating range, as shown in Figure 100. The phase noise for a particular IF input frequency can be calculated using Equation 5.

$$PN_{IN_OFFSET} = PN_{CLK_OFFSET} + 20 \times \log (F_{IF}/F_{ADC}) \quad (7)$$

For example, the phase noise at 1 MHz offset for an F_{ADC} of 3.2 GHz is approximately -124 dBc/Hz. An IF input frequency of 200 MHz results in a 24 dB improvement, thus the expected phase noise at 1 MHz offset is -148 dBc/Hz.

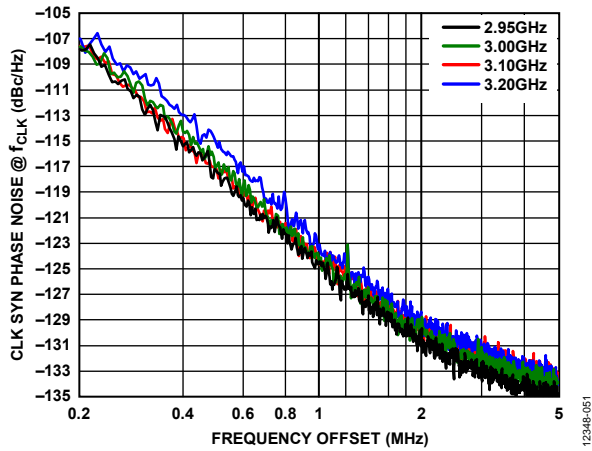

Figure 100. Clock Synthesizers Typical Phase Noise for Various F_{ADC} Values

The repeatability of a device that is power cycled 10 times is shown in Figure 101. Note that the measured data in this figure aligns with the expected results based on Equation 5 and Figure 100. The phase noise variation over temperature of a nominal device is shown in Figure 102.

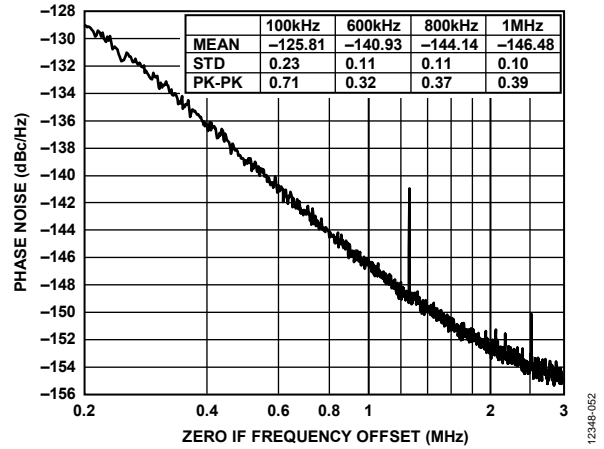

Figure 101. Power Cycle Repeatability (10 Attempts) of Phase Noise Measurement for an IF Input Frequency of 225 MHz and $f_{CLK} = 2.94912$ GHz with PLL PFD = 61.44 MHz

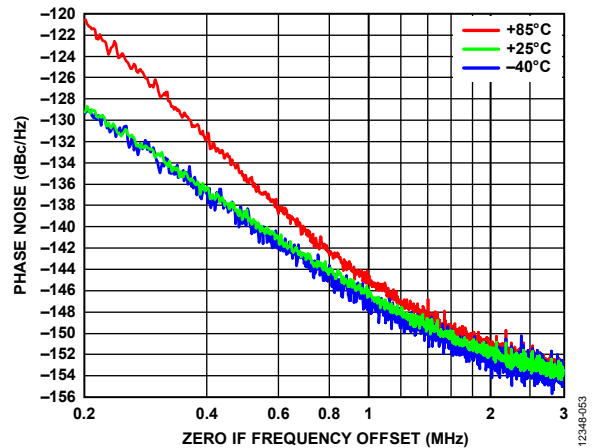

Figure 102. Typical Temperature Stability of Clock Synthesizer with the Same Conditions as Figure 101

DIGITAL PROCESSING BLOCKS

The AD6676 includes the following digital blocks between the Σ - Δ ADC output and JESD204B transmitter core:

- An ADC overload and recovery block immediately follows the ADC. This circuitry quickly detects any ADC instability from an overload event while ensuring fast recovery.
- A digital signal processing block translates the real IF signal from the Σ - Δ ADC to a complex zero IF, suitable for postprocessing by the host without loss of any dynamic range. This block includes both coarse and fine QDDCs, along with a selectable FIR decimation filter stage that provides decimation factors of 12, 16, 24, and 32.
- A peak detection and AGC support block facilitates the implementation of an external AGC control loop under the control of the host. Note that the AGC pins can also be repurposed for GPIO functions.

Figure 103 shows a diagram of the digital functional blocks along with the SPI configurable registers pertaining to these blocks. The following sections provide more insight into the operation of each of these functional blocks. More information pertaining to these SPI registers can be found in Table 32 through Table 135.

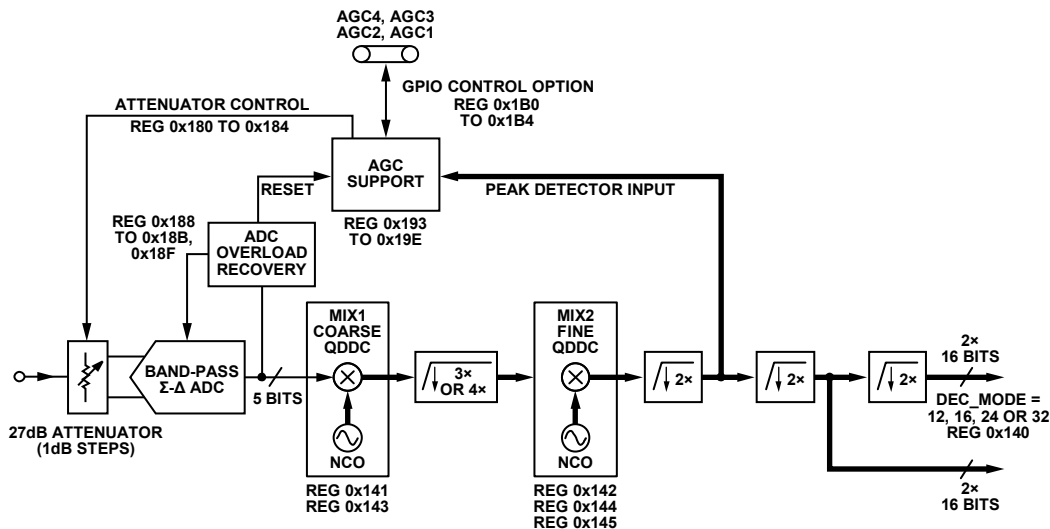

Figure 103. Simplified Block Diagram of Digital Processing Blocks

12248P-054

DIGITAL SIGNAL PROCESSING PATH

The Σ - Δ ADC provides a highly oversampled 5-bit digital output representing the desired IF signal pass band as well as the out-of-band shaped noise described earlier. Referring to Figure 104, the digital signal processing path translates this oversampled real IF signal to a complex dc centered IF signal, having a more manageable data rate suitable for transfer via the JESD204B interface. The QDDC performs the real-to-complex frequency translation followed by digital filtering to remove the ADC out-of-band noise, as well as any other undesired signal content, before decimation to a lower data rate without any loss of dynamic range.

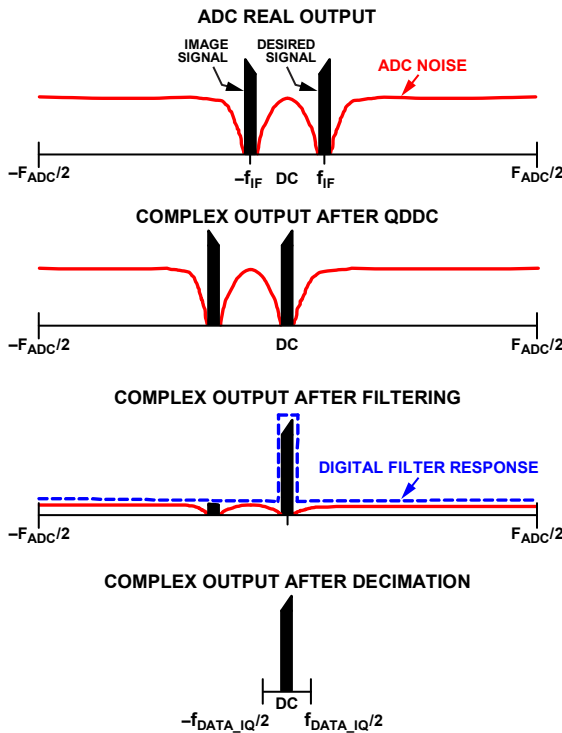

Figure 104. Digital Signal Processing Path Performs Frequency Translation to a Zero IF as well as Filtering and Downsampling

Quadrature Digital Downconversion

Digital downconversion occurs in two stages using a coarse and a fine QDDC. As shown in Figure 103, the coarse QDDC resides immediately after the Σ - Δ ADC and the fine QDDC follows the first decimation stage. The coarse QDDC provides 6-bit tuning resolution whereas the fine QDDC provides 10-bit tuning resolution. The composite tuning resolution is either $F_{ADC}/3072$ or $F_{ADC}/4096$, depending on whether the first decimation stage is configured for 3x or 4x decimation, which in turn depends on the decimation mode selected as described in Table 13. For applications requiring finer tuning resolution to position the IF signal exactly about dc, consider adding a finer resolution QDDC in the host processor.

Table 13. Finite Composite Tuning Resolution of Coarse and Fine NCO

DEC_MODE (Register 0x140, Bits[2:0])	Decimation Factor	Tuning Resolution	Tuning Res. (MHz) at $F_{ADC} = 3.072$ GSPS
1	32	$F_{ADC}/4096$	0.75
2	24	$F_{ADC}/3072$	1.00
3	16	$F_{ADC}/4096$	0.75
4	12	$F_{ADC}/3072$	1.00

The tuning frequency settings of the combined coarse and fine NCO (SPI Register 0x141 and SPI Register 0x142) are automatically calculated and set by the AD6676 during the device SPI initialization phase. The user defined F_{ADC} and IF settings (SPI Register 0x100 thru SPI Register 0x103) are used to calculate the settings such that the center of the IF pass band is centered about dc. The coarse tuning NCO is set via MIX1_TUNING[5:0], whereas the fine tuning NCO is set via MIX2_TUNING[7:0]. The decimal equivalent frequency setting of each NCO register is based on the following equations.

$$MIX1 = \text{Round} \left(64 \times \frac{F_{IF}}{F_{ADC}} \right) \quad (8)$$

where:

MIX1 is a 6-bit binary number representing the NCO frequency setting in MIX1_TUNING.

F_{IF} is the desired carrier frequency in hertz (Hz).

F_{ADC} is the ADC clock rate in hertz (Hz).

$$MIX2 = \text{Round} \left(M \times \left(\frac{F_{IF}}{F_{ADC}} - \frac{MIX1}{64} \right) \right) \quad (9)$$

where:

MIX2 is a 8-bit twos complement number representing the NCO frequency setting in MIX2_TUNING.

M is 3072 for DEC_MODE = 2 and 4, or 4096 for DEC_MODE = 1 and 3.

It is important to note the residue, f_{OFFSET} , between the desired F_{IF} and the AD6676 composite NCO setting, F_{IF_NCO} , because any offset may need to be compensated with an additional fine QDDC located in the host processor. Use the following equations to calculate both parameters:

$$F_{IF_NCO} = \left(\frac{MIX1}{64} + \frac{MIX2}{M} \right) \times F_{ADC} \quad (10)$$

$$f_{OFFSET} = F_{IF} - F_{IF_NCO} \quad (11)$$

Example

Calculate the NCO MIX1 and MIX2 values along with F_{IF_NCO} and f_{OFFSET} with the following AD6676 configuration: $F_{IF} = 140$ MHz, $F_{ADC} = 3200$ MHz, and decimation factor of 16 (that is, $f_{DATA_IQ} = 200$ MSPS).

- Substituting F_{IF} and F_{ADC} values in Equation 8 results in $MIX1 = 3$.
- Substituting these values in Equation 9 (noting that $M = 4096$ for $DEC_MODE = 3$ results in $MIX2 = -13$).
- Substituting $MIX1$ and $MIX2$ values into Equation 10 results in $F_{IF_NCO} = 139.84375$ MHz.
- Substituting F_{IF} and F_{IF_NCO} values in Equation 11 results in $f_{OFFSET} = 156.25$ kHz.

NCO Phase Synchronization

The AD6676 coarse and fine tuning NCOs can be set to an initial phase after synchronization with an external SYSREF signal. The initial phase of the coarse tuning NCO is set via $MIX1_INIT$, with an LSB corresponding to $1/64^{th}$ of a cycle. The initial phase of the fine tuning NCO is set via $MIX2_INIT_x$, with an LSB corresponding to $1/1024^{th}$ of a cycle.

Digital Filter Modes

The AD6676 digital filter path is designed to provide sufficient stop band rejection of the Σ - Δ ADC shaped out-of-band noise as well as any spurious noise that otherwise might alias back into the desired pass band region after decimation and limit the actual NSD performance. The filter path supports decimation factors of 12, 16, 24, and 32 depending on the DEC_MODE setting. The complex output of the coarse QDDC feeds a pair of symmetrical FIR decimation filters divided into three stages, as shown in Figure 103. The first stage is a decimate by 3 or by 4 filter, depending on whether the desired decimation factor is divisible by three. The second and third stages consists of two cascaded decimate by 2 filters with the third stage outputs supporting the decimate by 12 and by 16 options. A bypassable fourth stage provides the decimate by 24 and by 32 options.

The normalized pass band and wideband folded frequency response for each filter mode are shown in Figure 105 through Figure 113. Note the following observations:

- All filter responses provide a linear phase response over its pass band.
- The usable IF bandwidth depends on the DEC_MODE as well as the minimum acceptable pass band ripple and stop band rejection requirements. Table 14 provides the normalized usable complex bandwidth vs. DEC_MODE for stop band rejections of greater than 85 dB and 60 dB.
- The last filter stage sets the usable bandwidth and stop band rejection because it has the most aggressive transition band specifications. For this reason, the decimation factors of 12 and 16 have the same normalized usable bandwidths as does decimation factors of 24 and 32.

- Wide IF bandwidths (MHz) are supported when operating at lower decimation factors along with a high F_{ADC} .
- It is worth noting that many applications requiring wider IF bandwidth may tolerate reduced ripple and rejection as the digital filter response enters its transition region. The reason is that the Σ - Δ ADC achievable NSD performance at the IF pass band edges also degrades as its oversampling ratio is reduced, thus still dominating relative to any aliased noise due to reduced filter stop band rejection.

Table 14. Usable Normalized Complex Bandwidth vs. Decimation Factor

DEC_MODE	Decimation Factor	f_{DATA_IQ}	BW (>85 dB Rejection)	BW (>60 dB Rejection)
1	32	1	0.814	0.834
2	24	1	0.814	0.834
3	16	1	0.571	0.617
4	12	1	0.571	0.617

Total Pipeline Latency

The digital filter path dominates the latency of the AD6676 whereas the JESD204B PHY adds a few samples of delay and the ADC delay is a fraction of an output sample. The latency between the ADC and digital filter output is fixed with the only nondeterministic delay being associated with the JESD204B PHY clock and lane FIFOs before synchronization. See the Synchronization Using SYSREF section for additional information. Table 15 provides the nominal pipeline delay associated with each DEC_MODE . Note that although all DEC_MODE settings provide similar delays relative to the output data rate, f_{DATA_IQ} , applications that require shorter absolute time delays may consider using a lower decimation factor to reduce the absolute delay by $2\times$.

Table 15. Nominal Pipeline Latency vs. DEC_MODE (Sample Delay Relative to $1/f_{DATA_IQ}$)

DEC_MODE	Decimation Factor	JESD204B Lanes	IQ Data Output Sample Delay
1	32	1	34.2
2	24	1	34.2
3	16	2	32.3
4	12	2	32.3

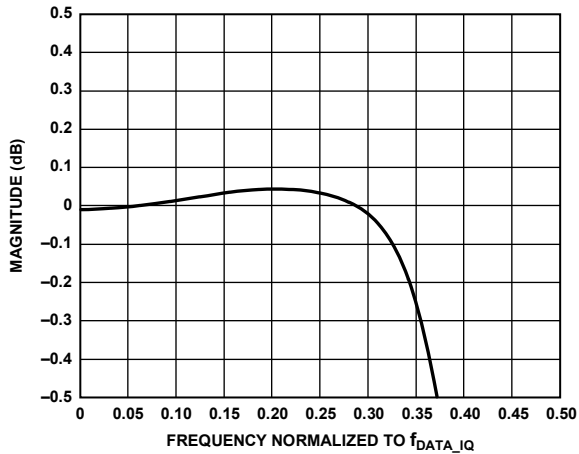

Figure 105. Pass Band Frequency Response of Decimate by 12

12348-056

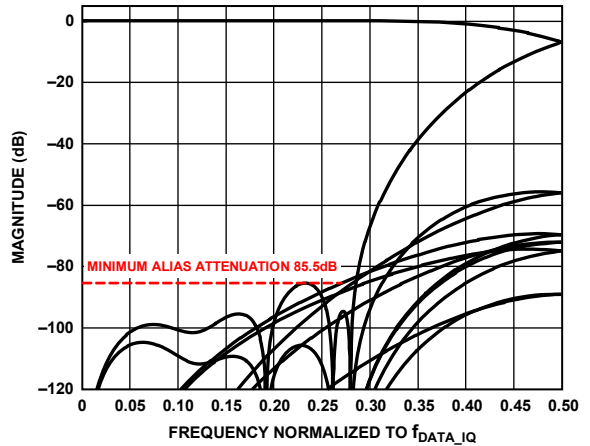

Figure 108. Folded Frequency Response of Decimate by 12 Shows Alias Rejection

12348-059

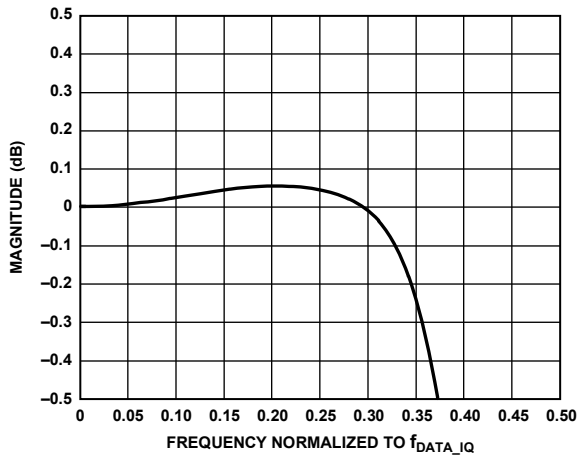

Figure 106. Pass Band Frequency Response of Decimate by 16

12348-057

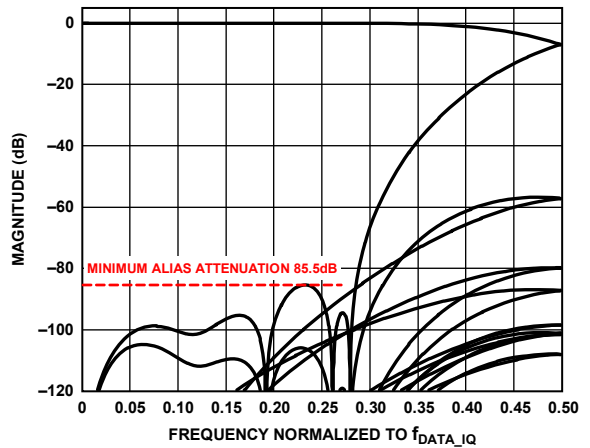

Figure 109. Folded Frequency Response of Decimate by 16 Shows Alias Rejection

12348-060

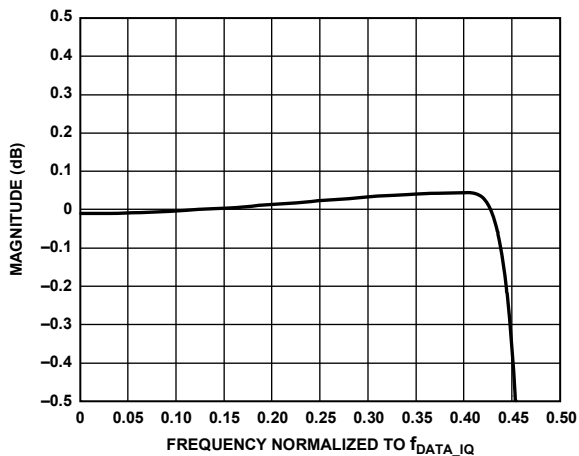

Figure 107. Pass Band Frequency Response of Decimate by 24

12348-058

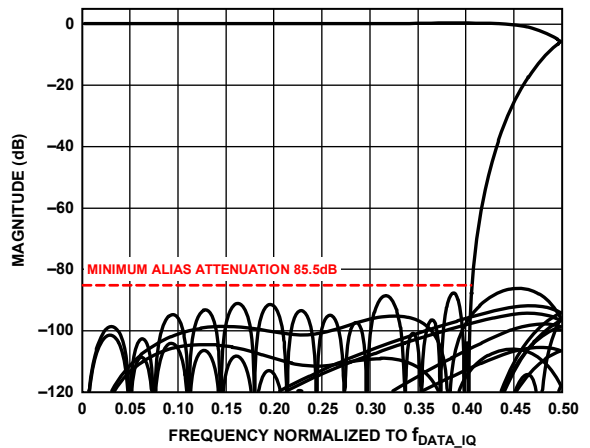

Figure 110. Folded Frequency Response of Decimate by 24 Shows Alias Rejection

12348-061

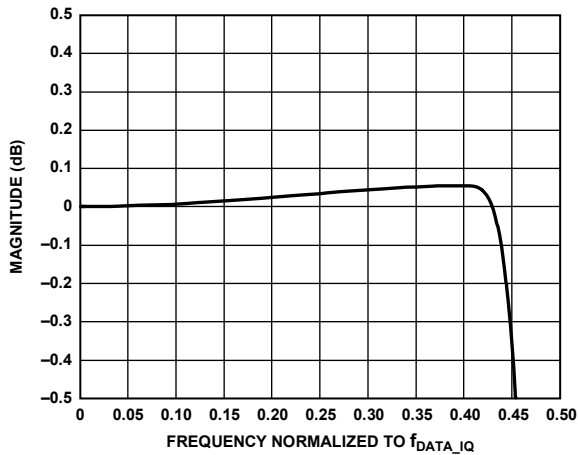

Figure 111. Pass Band Frequency Response of Decimate by 32

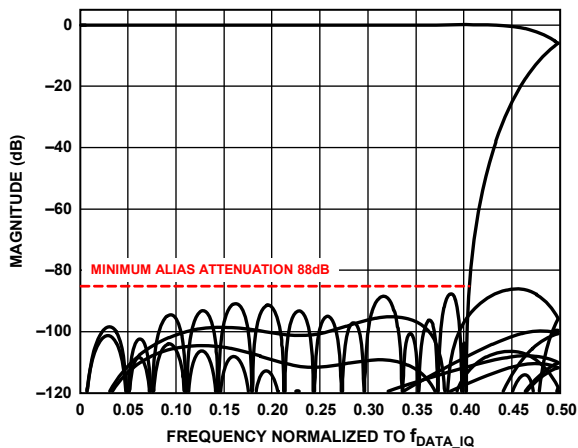

Figure 112. Folded Frequency Response of Decimate by 32 Shows Alias Rejection

AGC FEATURES AND PEAK DETECTION

In receiver applications, it is desirable to have a mechanism to reliably determine when the converter is about to be overdriven. The AD6676 Σ - Δ ADC is based on a feedback loop that can be overdriven into a nonlinear region, resulting in oscillation. This oscillation persists until the Σ - Δ ADC is reset and the overload condition is removed. Typically, a receiver lineup employs some form of AGC that attempts to avoid this scenario.

The AD6676 pipeline latency along with any additional overhead associated with the host processor (JESD204B Rx PHY) may limit the ability to design a fast reacting digital-based AGC required by some applications. For this reason, the AD6676 includes the AGCx pins that serve as digital input/outputs to facilitate the implementation of a fast AGC control loop under the control of the host. The AGC4 and AGC3 pins can be allocated to provide flag outputs after a programmable threshold has been exceeded, including an ADC reset event, while the AGC2 and AGC1 pins can be used to control the on-chip attenuator. Register 0x18F and Register 0x193 through Register 0x19E are used for AGC purposes.

Peak Detection and AGC Flags

Peak detection occurs at the output of the second stage decimation filter, as shown in Figure 103. Detection at this stage represents a compromise between the accuracy of the peak detector, delay time and ability to measure large out-of-band signals. At this stage, the Σ - Δ ADC output signal has been frequency translated to dc and its out-of-band noise sufficiently filtered for reasonable threshold detection accuracy down to -12 dBFS peak signal levels. Note that the peak detector monitors the peak power envelope response of the IF input signal and calculates the peak power (that is, $I^2 + Q^2$) expressed in dBFS with 12-bit resolution.

Because the peak detector is monitoring the peak power at the output of the second stage decimation filter, it provides a wider frequency range than what can be observed in the final IQ data output. The first stage filter is decimate by 3 or by 4; therefore, the output of the second stage filter can be 1/6th or 1/8th of F_{ADC}. Figure 113 shows the normalized measurement bandwidth relative to the output rate of the second stage filter centered about its zero IF. Table 16 references the measurement bandwidth to f_{DATA_IQ} for the different decimation factors such that its absolute bandwidth can be easily determined. For example, the -1 dB bandwidth for an f_{DATA_IQ} of 100 MSPS with decimate by 24 or by 32 is 200 MHz and remains at 200 MHz if the decimation factor is reduced to decimate by 12 or by 16. Any droop occurring at the pass band edges, as well as the Σ - Δ ADC STF, must be considered when setting thresholds.

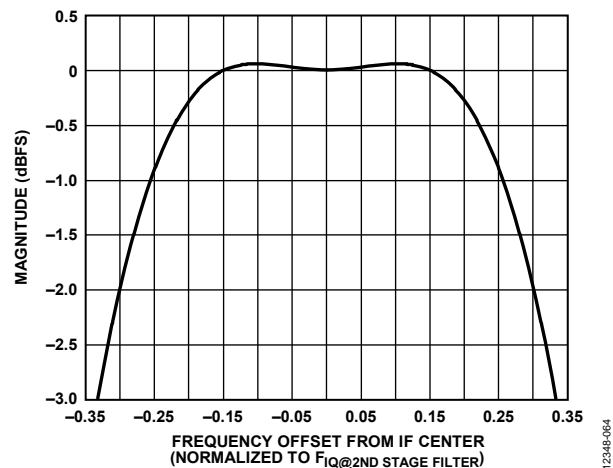

Figure 113. Normalized Pass Band Filter Response Seen by the Peak Detector

Table 16. Normalized Measurement Bandwidth of Peak Detector Relative to Output Data Rate, f_{DATA_IQ}

DEC MODE	Decimation Factor	Normalized Measurement Bandwidth Relative to f _{DATA_IQ}			
		-0.5 dBFS	-1.0 dBFS	-2.0 dBFS	-3.0 dBFS
1	32	1.76	2.00	2.40	2.64
2	24	1.76	2.00	2.40	2.64
3	16	0.88	1.00	1.20	1.32
4	12	0.88	1.00	1.20	1.32

The AD6676 allows the user to set three threshold settings that can trigger one of two possible flags. PKTHRH0 and PKTHRH1 are two upper threshold settings while LOWTHRH is a lower threshold setting. The threshold settings are 12 bits with an MSB and LSB register assigned to each threshold. The 12-bit decimal equivalent value can be calculated using Equation 12.

$$\text{Threshold} = 3584 + (\text{Threshold Setting in dBFS}) \times 256/3 \quad (12)$$

where 0 dBFS corresponds to 3584 (0xE00) and -6 dBFS corresponds to 3072 (0xC00).

In the time domain, a 0 dBFS setting corresponds to a signal whose peaks observed at the I and Q outputs can reach plus or minus full scale. Meaning, if the 16-bit I and Q output data are normalized such that its peak values correspond to ± 1 , a 0 dBFS setting corresponds to a signal whose peak can reach the unit circle of a normalized I/Q constellation diagram.

The LOWTHRH_x register has an associated dwell time of which the signal must remain below this threshold before a flag can be set. The dwell time is represented in exponential form to realize long dwell periods because the counter operates at $F_{\text{ADC}}/12$ for decimate by 12 or 24 settings or $F_{\text{ADC}}/16$ for decimate by 16 or 32 settings. The dwell time is set in the DWELL_TIME_MANTISSA register and DWELL_TIME_EXP register using Equation 13 relative to $1/F_{\text{ADC}}$.

$$\text{Dwell Time} = N \times [DWELL_TIME_MANTISSA] \times 2^{(DWELL_TIME_EXP)} \quad (13)$$

where:

$N = 12$ for decimate by 12 or 24.

$N = 16$ for decimate by 16 or 32.

A flag function can be assigned using the FLAG0_SEL register and FLAG1_SEL register to indicate when any of the thresholds have been exceeded or if an ADC reset event has occurred. These flags must also be enabled via the EN_FLAG register such that a CMOS level signal appears on the AGC4 and AGC3 pins where a logic high indicates when a threshold has been exceeded.

The delay relative to the ADC input when an AGC threshold is exceeded to when the flag signal goes high is dependent on the DEC_MODE setting selected. For a DEC_MODE value of 1 or 2 (decimate by 32 or 24), the delay equates to 8 to 9 output samples ($1/f_{\text{DATA_IQ}}$). For DEC_MODE values of 3 or 4 (decimate by 16 or 12), the delay is 16 to 18 samples. The delay associated with an ADC reset event is much shorter because it avoids the digital filter path. This delay is 1 sample for DEC_MODE values of 1 or 2 and 2 samples for DEC_MODE values of 3 and 4.

Note that the EN_FLAGx bits provide the additional option of logically OR'ing an ADC reset event with an upper peak threshold event to provide an even faster output flag to the host processor indicating that the attenuation must be applied. This scenario applies to the extreme case where the envelope response of a blocker is exceedingly fast, such that the AGC cannot react fast enough to the upper peak threshold setting flag to prevent overloading the Σ - Δ ADC.

Figure 114 provides an example of how the Flag 0 and Flag 1 assigned pins behave to the envelope response of an arbitrary IF input signal. Flag 1 is assigned an upper threshold set by PKTHRH1_x, and Flag 0 is assigned a lower threshold and dwell time set by LOWTHRH_x and DWELL_TIME_x. The Flag 1 indicator goes high when the PKTTHR1_x threshold is exceeded and returns low when the signal envelope falls below this threshold. The Flag 0 indicator goes high only when the envelope of the signal remains below the LOWTHRH_x threshold for the designated dwell time. If the signal level exceeds the LOWTHRH_x threshold before the dwell time counter has expired, the dwell time counter resets again and the Flag 0 indicator remains low until the conditions has been met.

By offsetting the PKTTHR1_x and LOWTHRH_x threshold settings as well as optimizing the dwell time setting, it may be possible to optimize the operation of an AGC so that it reacts to signal strength variation due to fading conditions as opposed to the peak to minimum response associated with digital modulated signals.

IF Attenuator Control via the AGC2 and AGC1 Pins

Many AGC implementations require fast gain control if the AGC threshold is exceeded. The AD6676 provides two modes in which the IF attenuator can be quickly changed via the AGCx pins. Use Register 0x180, Bit 0, to select the mode. The first mode uses the AGC2 pin to switch between two attenuator settings that are user defined in Register 0x181 and Register 0x182. The second mode uses the AGC2 and AGC1 pins to decrement and increment respectively the attenuation value in 1 dB steps with pulsed inputs. The starting attenuator value is defined in Register 0x183. The actual attenuator value can be read back via Register 0x184.

The first mode is used for the default AD6676 power-up setting with both Register 0x181 and Register 0x182 set to 0x0C. For applications that do not require IF attenuator control but require a different attenuator setting, update both registers with the desired attenuator setting value such that the attenuator remains independent of the AGC2 pin state, if it is left floating. Note that connecting the unused AGC2 and AGC1 pins to VSSD via 100 k Ω pull-down resistors is still the preferred method if these pins are unused.

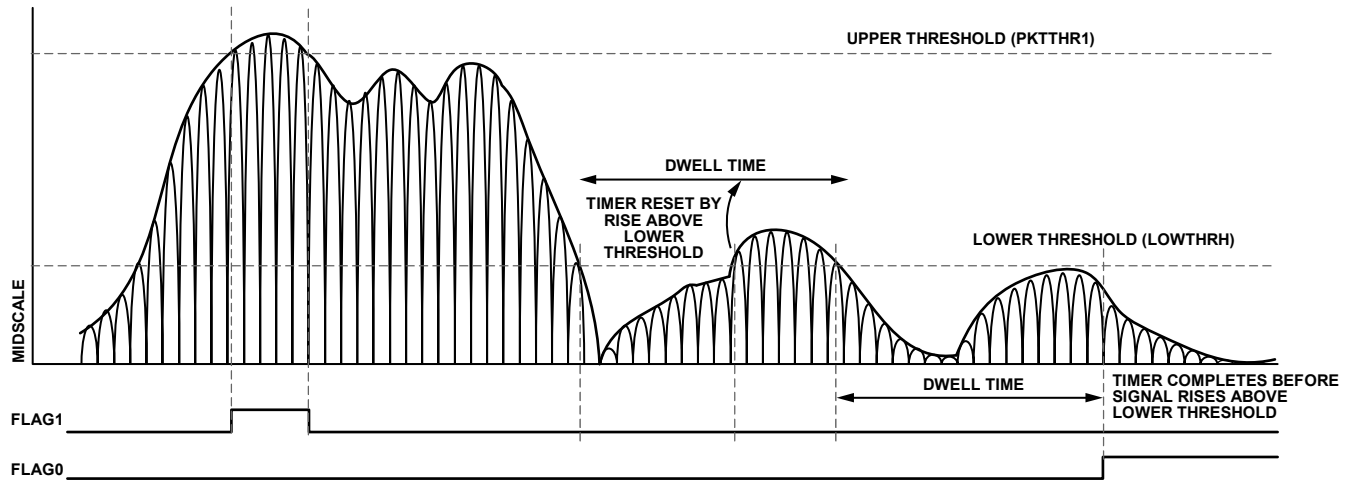

Figure 114. Example of Flag Behavior as Signal Envelope Crosses Upper and Lower Threshold Settings

Table 17. Power Saving for 3.0 GSPS Operation with CLKSYN Enabled and 125 MSPS IQ Rate (Single JESD204B Lane)

Power State at 3 GSPS	I _{VDD2} (mA)	I _{VDD1+} , I _{VDDC+} I _{VDDL} (mA)	I _{VDD} (mA)	P _{TOTAL} (mW)	Percent (%) Power Savings
STDBY_SLOW	18	162	216	461	61
STDBY_FAST	95	175	221	673	43
Power Down	2.6	25	29	64	Not applicable
Power Up	146	433	310	1182	Not applicable

GPIO FUNCTIONALITY

The AGC_x pins can also be configured for basic GPIO functionality via Register 0x1B0 to Register 0x1B4. Register 0x1B0 determines which pins are used for GPIO functionality, whereas Register 0x1B1 determines if an AGC pin serves as input or output. If the pin serves as an output, Register 0x1B2 determines the high or low state, and Register 0x1B3 reads back the state of these designated output pins. Lastly, if an AGC_x pin serves as an input, Register 0x1B4 reads back the state of this pin.

POWER SAVING MODES

The AD6676 features two SPI configurable and selectable power savings modes. The first mode is a sleep mode where the AD6676 is placed in a low power state for extended periods, and the second mode is a standby mode where the AD6676 enters a reduced power state but still keeps the JESD204B link and digital clocks active to ensure multichip synchronization (or fixed latency) during fast power cycling. Both sleep mode and standby mode can be entered via a SPI write operation to the PD_MODE bits in the DEVICE_CONFIG register (Register 0x002; Bits[1:0]). Note that, depending on whether sleep or standby mode is selected, various functional blocks within the Σ - Δ ADC itself are either powered down, placed in a low bias state, or remain powered.

The standby mode is also controllable via a user designated AGC_x pin for faster and more precise power cycling. This feature is particularly useful for TDD-based communication protocols, allowing the host processor to quickly power cycle the AD6676 during transmit bursts. The PD_PIN_CTRL register (Register 0x152) enables this feature as well as designates the AGC pin.

The standby register (Register 0x150) powers down different functional blocks during standby mode. However, all functional blocks that affect the clock generation, distribution and the JESD204B link remain enabled to maintain constant latency while in standby. The only exception is STBY_VSS2GEN (Register 0x150, Bit 6) where a trade-off exists in power savings vs. wake-up time, depending on whether the negative voltage generator is placed in standby.

Table 17 shows the realized power savings for the different power savings modes at 3.0 GSPS operation with the AD6676 configured for 125 MSPS IQ output and the internal clock synthesizer enabled. Note that STDBY_FAST and STDBY_SLOW correspond to whether the STBY_VSS2GEN bit is enabled or disabled during standby. Note that an additional 18% power savings can be achieved when powering down the STBY_VSS2GEN bit.

Although the AD6676 can enter into standby quickly, it does require a few microseconds to exit standby. Figure 115 shows that the AD6676 can achieve a low power state within 100 ns. Figure 116 and Figure 117 show the wake-up time between the STDBY_FAST and STDBY_SLOW cases to achieve 1% envelope settling accuracy being around 2.5 μ s and 11.5 μ s, respectively. The phase response is not shown because it settles faster than the envelope response. Note that the digital data path is enabled for these time domain figures such that the setting time responses can be observed.

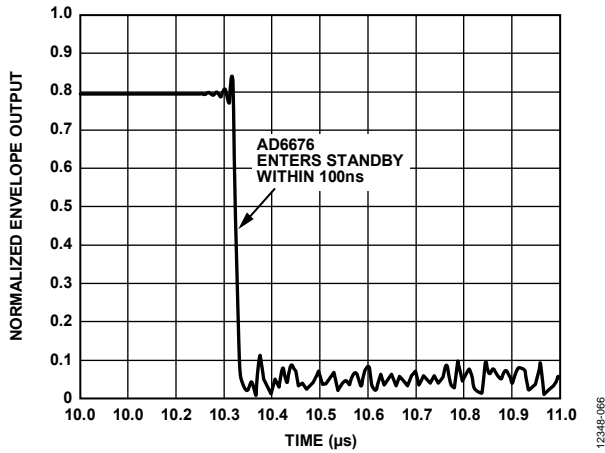

Figure 115. Fast Power-Down Response When the AD6676 Is Placed in Standby

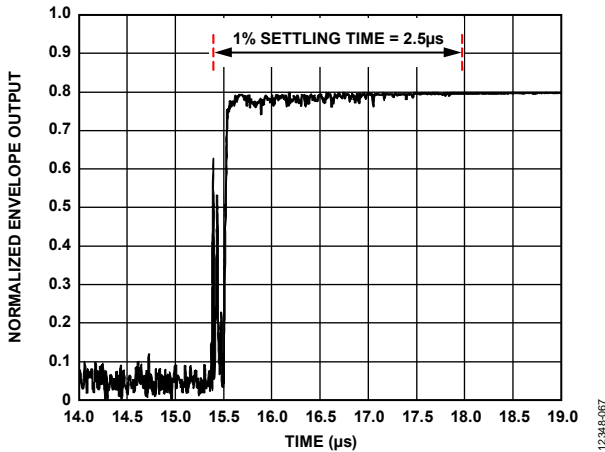

Figure 116. Settling Time for STDBY_FAST with the STBY_VSS2GEN Enabled for Fastest Recovery, Approximately 2.5 µs to 1 %

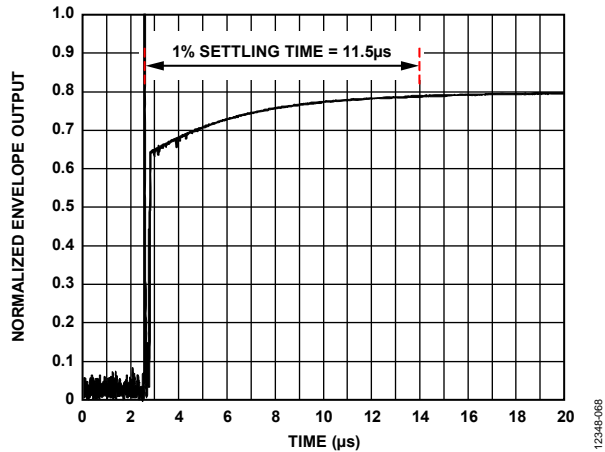

Figure 117. Settling Time for STDBY_SLOW with STBY_VSS2GEN in Standby for Additional Power Savings, Approximately 11.5 µs to 1 %

INTRODUCTION TO THE JESD204B INTERFACE

The JESD204B interface reduces the PCB area for data interface routing yet enabling the use of smaller packages for converter and logic devices. The AD6676 digital output complies with the JEDEC Standard No. JESD204B, *Serial Interface for Data Converters*. JESD204B is a protocol to link the AD6676 to a digital processing device over a serial interface. The AD6676 supports link rates of up to 5.333 Gbps while operating with two output lanes in support of a maximum I/Q data rate ($f_{DATA,IQ}$) of 266.67 MSPS. Note that a two output lane configuration is always required for decimation factors of 12 and 16.

JESD204B Overview

JESD204B data transmit block assembles the parallel data from the ADC into frames and uses 8-bit/10-bit encoding as well as optional scrambling to form serial output data. Lane synchronization is supported through the use of special characters during the initial establishment of the link and additional synchronization is embedded in the data stream thereafter. A JESD204B receiver is required to complete the serial link. For additional details on the JESD204B interface, refer to the JESD204B standard.

Because the AD6676 provides 16-bit complex IQ data, its JESD204B transmit block effectively maps the output of two virtual ADCs ($M = 2$) over a link. The link is configurable for either single or dual lanes with each lane providing a serial data stream via a differential output. The JESD204B specification refers to a number of parameters to define the link and these parameters must match between the AD6676 JESD204B transmitter and receiver.

The following parameters describe a JESD204B link:

- S = samples transmitted per single converter per frame cycle (AD6676 value = 1)
- M = number of converters per converter device (AD6676 value = 2)
- L = number of lanes per converter device (AD6676 value can be 1 or 2)
- N = converter resolution (AD6676 value = 16)
- N' = total number of bits per sample (AD6676 value = 16)
- CF = number of control words per frame clock cycle per converter device (AD6676 value = 0)
- CS = number of control bits per conversion sample (AD6676 value = 0)
- K = number of frames per multiframe (configurable on the AD6676 up to 32)
- HD = high density mode (AD6676 value = 0)
- F = octets per frame (AD6676 value = 2 or 4, dependent on L = 2 or 1)
- T = tail bit (AD6676 value = 0)
- SCR = scrambler enable or disable (configurable on the AD6676)

Figure 118 shows a simplified block diagram of the AD6676 JESD204B link mapping the 16-bit I and Q outputs onto the two separate lanes. Other configurations are also possible, such as combining the I and Q outputs onto a single lane ($f_{DATA_IQ} \leq 153.6$ MSPS) or changing the mapping of the I and Q output paths. In any case, the 16-bit I and Q data are each broken into two octets (eight bits of data). Bit 15 (MSB) through Bit 8 are in the first octet. The second octet contains Bit 7 through Bit 0 (LSB). The four resulting octets (2 I octets and 2 Q octets) may be scrambled. Scrambling is optional but is available to avoid spectral peaks when transmitting similar digital data patterns.

The scrambler uses a self synchronizing polynomial-based algorithm defined by the equation $1 + x^{14} + x^{15}$. The descrambler in the receiver must be a self synchronizing version of the scrambler polynomial.

The four octets are then encoded with an 8-bit/10-bit encoder. The 8-bit/10-bit encoder takes eight bits of data (an octet) and encodes them into a 10-bit symbol. Figure 119 shows how the 16-bit I or Q data is taken from the final decimation stage, formed into octets, the two octets are scrambled, and how the octets are encoded into two 10-bit symbols.

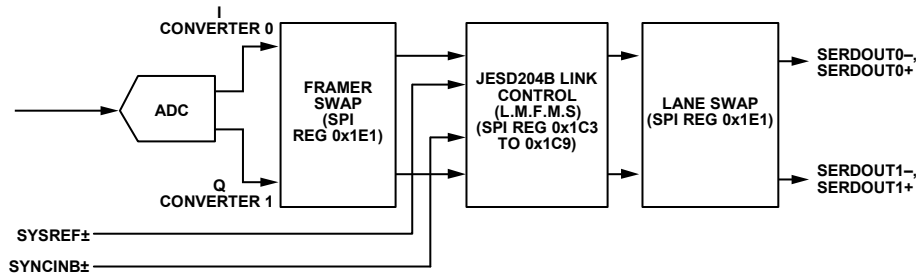

Figure 118. Transmit Link Simplified Block Diagram

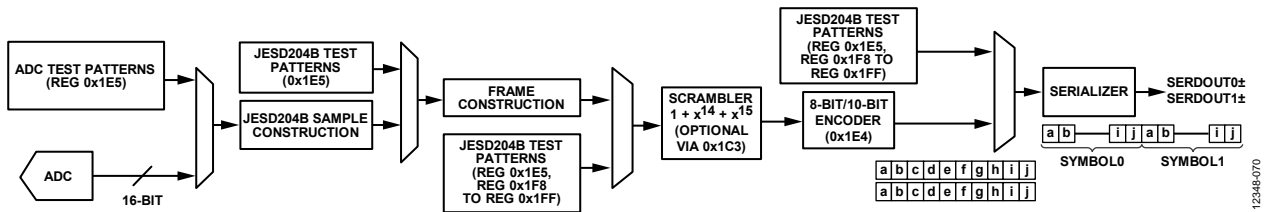

Figure 119. Digital Formatting of JESD204B Lanes

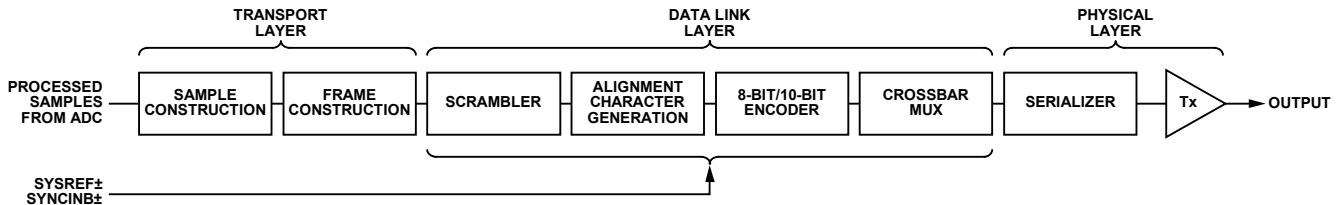

Figure 120. Data Flow

FUNCTIONAL OVERVIEW

The flowchart in Figure 120 shows the flow of data through the JESD204B hardware from the sample input to the physical output. The processing is divided into layers that are derived from the OSI model widely used to describe the abstraction layers of communications systems. These are the transport layer, the data link layer, and the physical layer (serializer and output driver).

Transport Layer

The transport layer packs the data into JESD204B frames, which are mapped to 8-bit octets that are sent to the data link layer. The transport layer mapping is controlled by rules derived from the link parameters. The AD6676 uses no tail bits in the transport layer because the output of its IQ digital data path is considered two virtual 16-bit converters.

Data Link Layer

The data link layer is responsible for the low level functions of passing data across the link. These include optional data scrambling, inserting control characters for lane alignment/monitoring, and encoding 8-bit octets into 10-bit symbols. The data link layer also sends the initial lane alignment sequence (ILAS), which contains the link configuration data, and is used by the receiver to verify the settings in the transport layer.

Physical Layer

The physical layer consists of the high speed circuitry clocked at the serial clock rate. For the AD6676, the 16-bit I and Q data are converted into one or two lanes of high speed differential serial data.

JESD204B LINK ESTABLISHMENT

The AD6676 JESD204B Tx interface operates in Subclass 0 or Subclass 1 as defined in the JEDEC Standard No. 204B (July 2011) specification. The link establishment process is divided into the following steps: code group synchronization, ILAS, and user data.

Code Group Synchronization (CGS) and SYNCINB

Code group synchronization (CGS) is the process where the JESD204B receiver finds the boundaries between the 10-bit symbols in the stream of data. During the CGS phase, the JESD204B transmit (JESD Tx) block transmits /K28.5/ characters. The receiver must locate /K28.5/ characters in its input data stream using clock and data recovery (CDR) techniques.

The receiver issues a synchronization request by asserting a low signal on the SYNCINB± pins of the AD6676. The JESD Tx begins to send /K/ characters. After the receiver has synchronized, it then deasserts its SYNCINB signal, causing it to go high. The AD6676 then transmits an ILAS on the following LMFC boundary.

For more information on the CGS phase, see the JEDEC Standard No. 204B (July 2011), Section 5.3.3.1.

The SYNCINB± pin operation options are controllable via SPI registers. Although the SYNCINB input is configured for a CMOS logic level on its positive pin by default, it can also be configured for a differential LVDS input signal on its positive/negative pins via Register 0x1E7. The polarity of the SYNCINB input signal can also be inverted via Register 0x1E4.

Initial Lane Alignment Sequence (ILAS)

The ILAS phase follows the CGS phase and begins on the next LMFC boundary. The ILAS consists of four multiframe, with a /R/ character marking the beginning and an /A/ character marking the end. The ILAS begins by sending an /R/ character followed by a data ramp starting with the value, 0, over four multiframe. On the second multiframe, the link configuration data is sent, starting with the third character. The second character in the second multiframe is a /Q/ character to confirm that the link configuration data follows. All undefined data slots are filled with ramp data. The ILAS sequence is never scrambled.

The ILAS sequence construction is shown in Figure 121. The four multiframe include the following:

- Multiframe 1: Begins with an /R/ character (/K28.0/) and ends with an /A/ character (/K28.3/).
- Multiframe 2: Begins with an /R/ character followed by a /Q/ (/K28.4/) character, followed by link configuration parameters over 14 configuration octets (see Table 18), and ends with an /A/ character. Many of the parameter values are of the notation of $n - 1$.
- Multiframe 3: Begins with an /R/ character (/K28.0/) and ends with an /A/ character (/K28.3/).
- Multiframe 4: Begins with an /R/ character (/K28.0/) and ends with an /A/ character (/K28.3/).

User Data and Error Detection

After the ILAS is complete, the user data is sent. Normally, in a frame all characters are user data. However, to monitor the frame clock and multiframe clock synchronization, there is a mechanism for replacing characters with /F/ or /A/ alignment characters when the data meets certain conditions. These conditions are different for unscrambled and scrambled data. The scrambling operation is disabled by default, but may be enabled via Register 0x1C3.

For scrambled data, any 0xFC character at the end of a frame is replaced by an /F/ and any 0x7C character at the end of a multiframe is replaced with an /A/. The JESD204B receiver checks for /F/ and /A/ characters in the received data stream and verifies that they only occur in the expected locations. If an unexpected /F/ or /A/ character is found, the receiver uses dynamic realignment or asserts the SYNCINB± signal for more than four frames to initiate a resynchronization. For unscrambled data, if the final character of two subsequent frames is equal, the second character is replaced with an /F/ if it is at the end of a frame, and an /A/ if it is at the end of a multiframe.

Insertion of alignment characters may be modified using SPI. The frame alignment character insertion is enabled by default. More information on the link controls is available in the SPI register descriptions for Register 0x1E0 to Register 0x1E6.

8-Bit/10-Bit Encoder

The 8-bit/10-bit encoder converts 8-bit octets into 10-bit symbols and inserts control characters into the stream when needed. The control characters used in JESD204B are shown in Table 18. The 8-bit/10-bit encoding ensures that the signal is dc balanced by using the same number of ones and zeroes across multiple symbols. Note that the 8-bit/10-bit interface has an invert option available in Register 0x1E4 that has the same effect of swapping the differential output data pins.

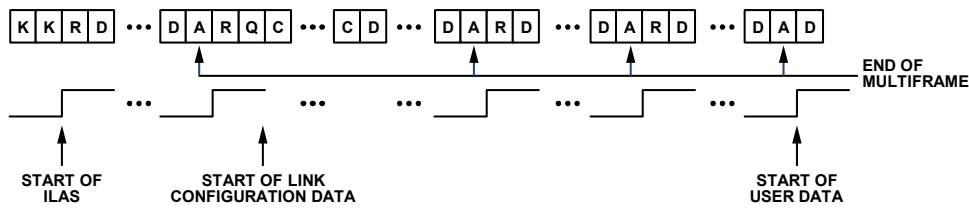

Figure 121. Initial Lane Alignment Sequence

Table 18. Control Characters used in JESD204B Including Running Disparity Values

Abbreviation	Control Symbol	8-Bit Value	10-Bit Value (RD = -1)	10-Bit Value (RD = +1)	Description
/R/	K28.0	000 11100	001111 0100	110000 1011	Start of multiframe
/A/	K28.3	011 11100	001111 0011	110000 1100	Lane alignment
/Q/	K28.4	100 11100	001111 0010	110000 1101	Start of link configuration data
/K/	K28.5	101 11100	001111 1010	110000 0101	Group synchronization
/F/	K28.7	111 11100	001111 1000	110000 0111	Frame alignment

PHYSICAL LAYER INPUT/OUTPUTS

Digital Inputs

The AD6676 physical layer consists of consists of two digital differential inputs, SYSREF± and SYNCIN±, whose equivalent input circuits are shown in Figure 61 and Figure 64. These inputs must be dc-coupled to their respective drivers because they are or can be aperiodic. The SYNCIN± input is logic compliant to both CMOS and LVDS via Register 0x1E7, Bit 2, with CMOS being the default. Note that the SYNCIN± input includes an internal 100 Ω termination resistor when LVDS is selected.

The optional SYSREF± input can be used for multichip synchronization or establishing a repeatable latency between the AD6676 and its host. The SYSREF± receiver circuit must be disabled if not used (Register 0x1E7 = 0x04) to prevent potential false triggering if the input pins are left open. The SYSREF± input does not include an internal 100 Ω termination resistor; thus, an external differential termination resistor must be included if this input is used. The SYSREF± input is logic compliant to LVPECL, LVDS, and CMOS.

Digital Outputs, Timing and Controls

The AD6676 physical layer consists of digital drivers that are defined in the JEDEC Standard No. 204B (July 2011). These CML drivers are powered up by default via Register 0x1E2. The drivers utilize a dynamic 100 Ω internal termination to reduce unwanted reflections. A 100 Ω differential termination resistor at each receiver input results in a nominal 300 mV p-p swing at the receiver.

The AD6676 JESD204B differential outputs can interface with custom ASICs and FPGA receivers, providing superior switching performance in noisy environments. Single point-to-point network topologies are recommended with receiver inputs having a nominal differential 100 Ω termination. The common mode of the digital output automatically biases itself to half the VDDHSI supply of 1.1 V (VCM = 0.55 V), thus making ac coupling the preferred coupling method to the receiver logic as shown Figure 122. DC coupling can be considered if the receiver device shares the same VDDHSI supply and input common-mode range.

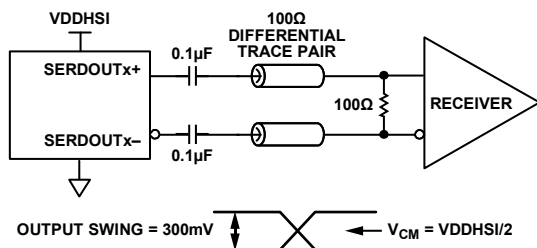

Figure 122. AC-Coupled Digital Output Termination Example

Timing errors caused by a degraded eye diagram at the receiver input can often be attributed to poor far end termination or differential trace routing. These potential error sources can be reduced by using well controlled differential 100 Ω traces with lengths below six inches that connect to receivers with integrated differential 100 Ω resistors.

Figure 123, Figure 124, and Figure 125 show examples of the digital output data eye, time interval error (TIE) jitter histogram, and bathtub curve for one AD6676 lane running at 5.333 Gbps with Register 0x1EC set to 0xBD. The format of the output data is twos complement by default. The output data format can be changed via Register 0x146.

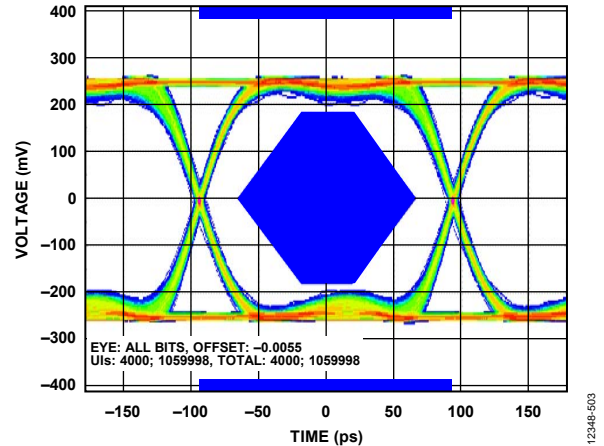

Figure 123. Digital Outputs Data Eye with External 100 Ω Terminations at 5.333 Gbps in Accordance to LV-OIF-11G-SR Mask

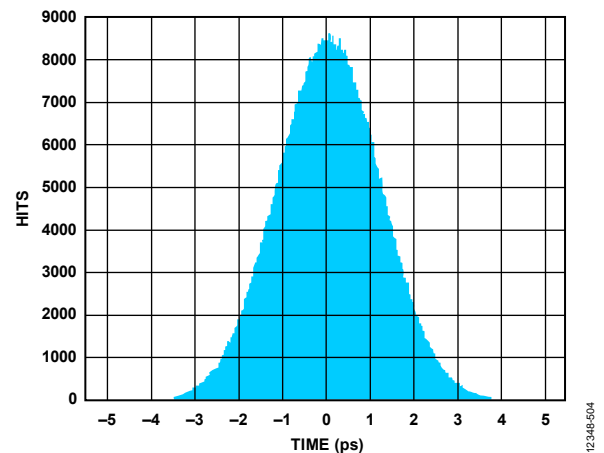

Figure 124. Digital Outputs Histogram with External 100 Ω Terminations at 5.333 Gbps

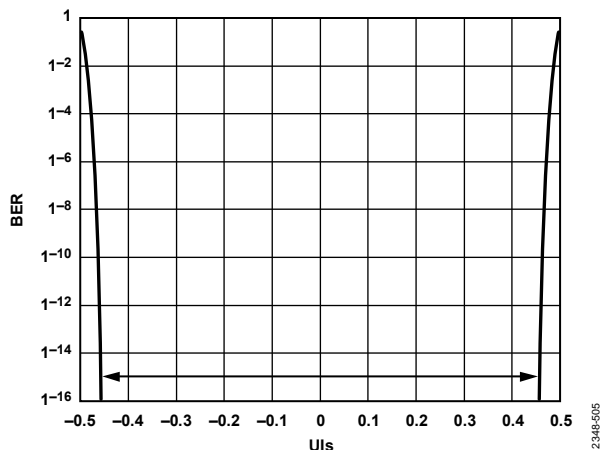

Figure 125. Digital Outputs Data Bathtub with External 100 Ω Terminations at 5.333 Gbps

Preemphasis

Preemphasis enables the receiver eye diagram mask to be met in conditions where the interconnect insertion loss does not meet the JESD204B specification. The preemphasis feature is controlled via Register 0x1EF and must be used only when the receiver cannot recover the clock due to excessive insertion loss. Under normal conditions, it is disabled to conserve power. Additionally, enabling and setting too high a deemphasis value on a short link may cause the receiver eye diagram to fail or lead to potential EMI issues. For these reasons, consider the use of preemphasis only in instances where meeting the receiver eye diagram mask is a challenge. See the Register Memory Map section for details.

Serializer PLL

This PLL generates the serializer clock that is equal to the JESD204B lane rate. The on-chip controller automatically configures the PLL parameters based on the user specified IQ data rate (F_{ADC}/M) and number of lanes. The status of the PLL lock can be checked via the PLL_LCK status bit in Register 0x2DC. This read only bit lets the user know if the PLL has achieved a lock for the specific setup.

CONFIGURING THE JESD204B LINK

The AD6676 has one JESD204B link. The serial outputs (SERDOUT0± and SERDOUT1±) are part of one JESD204B link. The basic parameters that determine the link setup are:

- L is the number of lanes per link
- M is the number of converters per link
- F is the number of octets per frame

The maximum and minimum specified lane rates for the AD6676 are 5.333 Gbps and 3.072 Gbps, respectively. For this reason, the AD6676 supports a single lane interface for IQ data rates (f_{DATA_IQ}) from 76.8 MSPS to 133.3 MSPS and a two lane interface from 153.6 MSPS to 266.7 MSPS.

The lane line rate is related to the JESD204B parameters using the following equation:

$$\text{Lane Line Rate} = \frac{(40 \times F_{DATA_IQ})}{L} \quad (14)$$

where:

$$F_{DATA_IQ} = \frac{F_{ADC}}{DEC}$$

The decimation ratio (DEC) is the parameter programmed into Register 0x140.

Table 19 shows the JESD204B output configurations supported based on f_{DATA_IQ} .

Table 19. JESD204B Output Configurations

No. Virtual Converters Supported (same as M)	f_{DATA_IQ} (MSPS)	JESD Serial Line Rate	L	M	F	S	HD	N	N'	K
2	76.8 to 133.3	$40 \times f_{DATA_IQ}$	1	2	4	1	0	16	16	For F = 4, K ≥ 5
	153.6 to 266.7	$20 \times f_{DATA_IQ}$	2	2	2	1	0	16	16	For F = 2, K ≥ 9

SYNCHRONIZATION USING SYSREF±

The AD6676 uses the SYSREF± input to provide synchronization for the JESD204B serial output and to establish a fixed phase reference for the decimation filters and the NCO within the QDDC. Synchronization options are configurable via Register 0x1E8. When initially synchronizing, the absolute phase offset relative to the input clock applied to the CLK± pins depends on internal clock phases and therefore has an uncertainty of ±1 ADC clock cycles.

A clock tree diagram is shown in Figure 126 with an internal clock signal, DIG_CLK, used to ultimately sample the SYSREF± signal. Note that the SYSREF± setup and hold times are defined with respect to the rising SYSREF± edge and rising CLK± (or CLK+ with the clock synthesizer disabled) edge, as shown in Figure 2. After the SYSREF± signal is sampled, the phase remains locked to the same relative internal ADC_CLK phase offset until the AD6676 is intentionally reset or its clock or power interrupted.

Note the following considerations when using SYSREF± for synchronization.

- The SYSREF± pulse width must be at least two ADC_CLK periods.
- Bit 3 of Register 0x2BB must be set low when synchronizing with the clock synthesizer enabled. In this case, that SYSREF± is sampled on the rising edge of REF_CLK to allow for significant margin in setup and hold time. This synchronization signal is then sampled again with the internally generated DIG_CLK.
- Because SYSREF± is ultimately sampled with an internal clock greater than 1 GHz, it can be difficult to maintain synchronization of the clock and SYSREF± distribution in a system over supply and temperature variations, as well as

cumulative jitter affects. Use the one shot with the second SYSREF pulse to avoid unnecessary resetting of the JESD204B link by setting Register 0x1E8 to 0x06. A minimum of two SYSREF pulses are required.

- The coarse and fine digital NCOs can be reset to an initial phase defined in Register 0x143 through Register 0x145 upon receiving SYSREF±. For the recommended one shot with the second SYSREF pulse, set Register 0x1E8 to 0x26 so that the same SYSREF pulse that is used to reset the JESD204 internal dividers is used to reset the NCO phases.
- If continuous SYSREF± is still preferred, it is recommended to use the SYSREF_WIN_NEG and SYSREF_WIN_POS bits in Register 0x1EA to allow for slight variation in SYSREF± timing relative to DIG_CLK.
- A phase variance of ±1 ADC clock cycles ultimately results in fractions of a sample when referenced to the IQ output data rate, f_{DATA_IQ} , depending on the decimation factor. For example, for a decimation factor of 32, the phase uncertainty is expressed as ±1/32 samples relative to f_{DATA_IQ} .
- The course and fine digital NCOs are also set to an initial phase up defined in Register 0x143 thru Register 0x145 upon receiving SYSREF±.
- Figure 127 shows how the HMC7044 (or the AD9528) can be used for mulichip synchronization. The HMC7044 is best suited for delivering a low phase noise RF clock source for each AD6676 (refer to Figure 135). In addition, its ability to individually control the delays of both the CLK and SYSREF signals to each AD6676 device allows compensation of PCB skew delays.

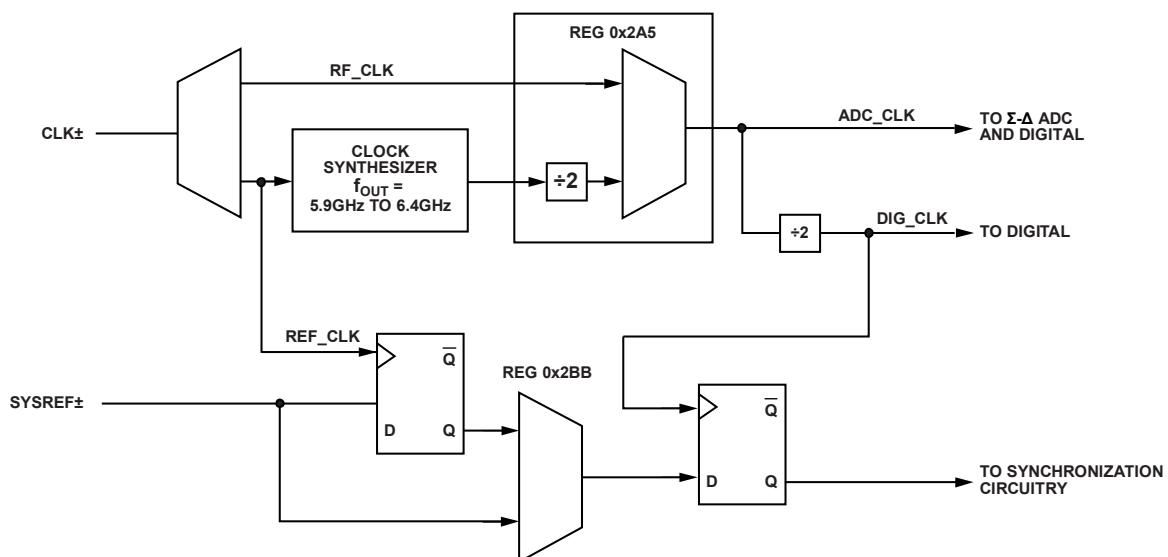

Figure 126. Block Diagram Showing Options of Sampling the SYSREF Input Signal with the Clock Synthesizer Disabled or Enabled

12348-131

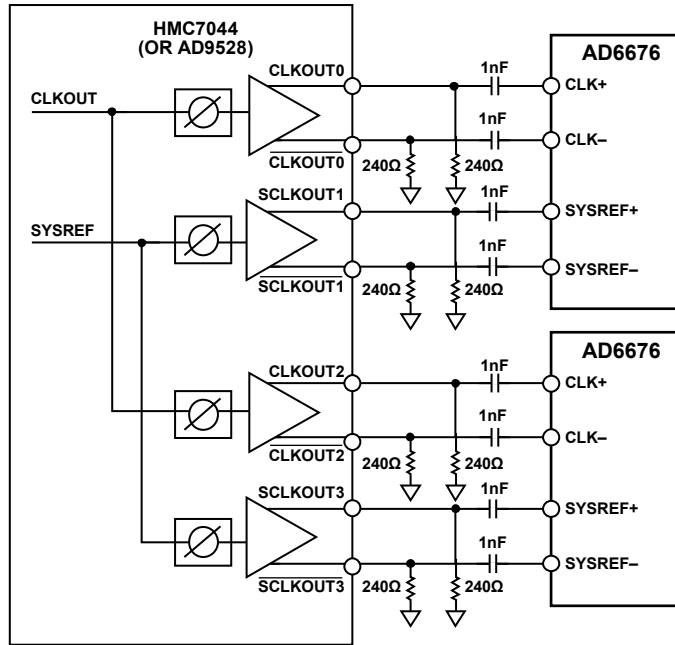

Figure 127. Example of Multichip Synchronization of the AD6676 Using the HMC7044 or the AD9528

APPLICATIONS INFORMATION

ANALOG INPUT CONSIDERATIONS

Equivalent Input Impedance and S11

The AD6676 benign input structure along with its low drive level requirements facilitates interfacing it to external driver circuitry. Figure 128 shows the equivalent parallel impedance for attenuator settings of 0 dB and 6 dB. Note that the slight variation in impedance between the different attenuator settings is an error source affecting the absolute accuracy of the attenuator settings. The AD6676 input also displays excellent S11 return loss over a wide frequency range, as shown in Figure 94.

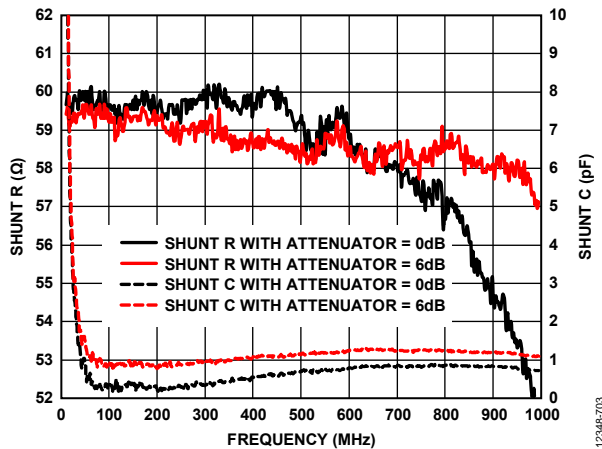

Figure 128. Typical Equivalent Parallel Impedance of AIN for Attenuator = 0 and 6 dB Settings

Input Driver and Filter Considerations

The input driver requirements, along with any additional filtering, are application dependent. Additional filtering maybe considered if any large signal content or blockers falling above or below the IF pass band of interest can cause desensitization by either increasing the ADC noise or spur floor. Below the IF pass band, the AD6676 is most sensitive to second harmonic content that is typically induced by the driver stage itself due to its limited IP2 performance. The AD6676 second-order nonlinearity contribution is typically on par with a balanced mixer and well below the contribution of a single-ended amplifier stage (with output balun) used for VHF applications. Table 20 shows the measured $f_1 + f_2$ spurious level and equivalent IIP2 for different IFs when dual tones are injected at -6 dBFS levels and at IF/2.

Table 20. Harmonic Levels When Dual Tones = -6 dBFS of PIN_0dBFS Level is Situated at IF/2

IF (MHz)	L _{EXT} (nH)	PIN_0dBFS (dBm)	Dual Tone Input Power (dBm)	f ₁ + f ₂ Spur (dBc)	Equivalent IP2 (dBm)
200	43	-2.5	-8.5	-69.5	61
250	19	-2.2	-8.2	-68.3	60
300	19	-2.2	-8.2	-73	65
350	10	-2.2	-8.2	-66.3	58.5
400	10	-2.2	-8.2	-68.5	60

Above the IF pass band, the AD6676 is sensitive to high frequency blockers that can increase the noise floor due to jitter or generate an image component that falls back into the pass band. The AD6676 is also fairly insensitive to spurious tones falling in the alias regions occurring at $F_{ADC} \pm F_{IF}$ because the AD6676 provides over 50 dB of alias rejection. Table 21 shows the typical alias rejection for different F_{ADC} and IF combinations. Because mixers often produce fixed large spurious at $M \times LO$ as well as its sum term of $LO + F_{RF}$, determine if any of these spurs can fall in the alias regions and if so, add the appropriate level of filtering to suppress them below the receivers required spurious level.

Table 21. Typical Alias Rejection for Different IF and ADC Combinations

F _{ADC} (MHz)	IF (MHz)	F _{ADC} - IF Alias Rejection (dBc)	F _{ADC} + IF Alias Rejection (dBc)
2000	150	58	59
2400	200	53	54
2800	300	51	59
3200	400	51	59

Because the required attenuation of out-of-band signal signals is application dependent, evaluate the AD6676 under the desired application conditions to understand the effects and determine what amount of filtering is required. In practice, a simple third-order low-pass roofing filter can provide adequate additional suppression against spurs falling in the alias regions as well as large signal signals falling a few 100 MHz above the IF pass band. Note that the AD6676EBZ includes an optional 500 MHz third-order low-pass filter (TDK MEA1210D501R) that may suffice for many applications. This small, 0302 size differential filter is also available with lower frequency options. Its effect on the pass band flatness is minimal but provides provides additional suppression beyond 700 MHz, as shown in Figure 129 as well as in the alias region as shown in Table 22.

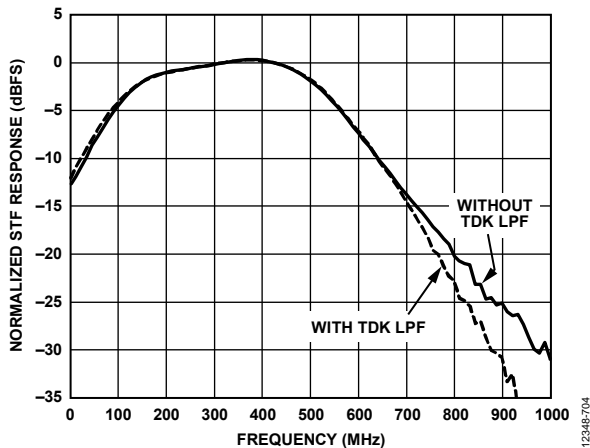

Figure 129. TDK Filter Has Minimal Effect on the Pass Band IF Response

Table 22. Typical Alias Rejection for Different IF and ADC Combinations with TDK 500 MHz Low-Pass Filter Added

F _{ADC} (MHz)	IF (MHz)	F _{ADC} – IF Alias Rejection (dBc)	F _{ADC} + IF Alias Rejection (dBc)
2000	150	82	83
2400	200	77	85
2800	300	71	83
3200	400	74	81

A 1:1 balun is required in applications where the last amplification stage is single-ended with a Z_{OUT} of 50 Ω . This is typically the case in a VHF receiver application where a gain block, such as the ADL5541 to ADL5545 series, precedes the AD6676 for preamplification.

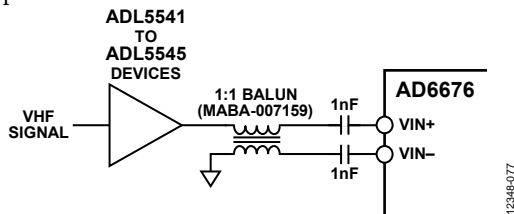

Figure 130. RF Line-Up for Direct Sampling VHF Application

For many RF receiver applications, this differential signal may originate from a RF-to-IF mixer whose output impedance often falls within a 50 Ω to 200 Ω range. A low order matching network that also serves as a low-pass roofing filter can compensate for the mismatch impedance. It is worth noting that the impedance mismatch between a source/load mismatch of 200 Ω /60 Ω and 100 Ω /60 Ω is approximately 1.5 dB and 0.3 dB, respectively. This low mismatch loss may be tolerable for some applications seeking a wide, low ripple IF pass band, especially considering the loss of a higher order matching network with finite Q components. Lastly, it is possible to reduce the ADC maximum input power requirements slightly to compensate for this low loss with minimal loss in dynamic range.

Other receiver applications in the VHF band may prefer that the AD6676 directly digitize the signal. Typically, the radio lineup may include a low NF gain block whose single-ended output is converted to a differential output via an ac-coupled balun. The amplitude/phase balance requirements of balun can be relaxed (compared to traditional pipeline ADCs) because the even order

harmonics that are sensitive to balance fall outside the pass band. Note that the second harmonic of the gain block still must fall outside the VHF pass band so that it can also be digitally filtered.

Some additional considerations pertaining to the analog input are as follows:

- AC coupling with 10 nF or greater capacitors to the VIN_{\pm} input is required to maintain 1 V common-mode voltage. Note that this capacitor provides a high-pass response with the AD6676 input impedance and thus must be sized accordingly for low IF applications to prevent excessive droop on the lower pass band response.
- A series 10 Ω resistor and 0.1 μ F decoupling capacitor is recommended between the 2.5 V supply and first resonators to provide additional filtering of supply induced noise and ADC common-mode currents.
- The feedback DAC (operating up to 3.2 GHz) also generates high frequency content (that is, images, clock feedthrough and shaped noise) that is ideally absorbed by the internal source follower. Due to its finite impedance at the higher frequencies, a small amount of this undesired signal content leaks through the attenuator path back to the VIN_{\pm} input. Passive mixers are particularly susceptible to this signal content due to poor isolation between the IF and RF ports while passive mixers with on-chip IF amps and active mixers provide a greater degree of reverse isolation. A simple third-order roofing filter typically provides sufficient rejection to suppress these ADC artifacts while also suppressing the larger $M \times N$ artifacts of the mixer. Note that this filter must be designed as two single-ended, pi network filters with shunt capacitors located next to the VIN_{\pm} pins to steer this undesired signal content to ground. Also, use care in component selection and layout to reduce parasitics that can cause unanticipated peaking in the stop-band region of the filter response.

CLOCK INPUT CONSIDERATIONS

The AD6676 Σ - Δ ADC operates with an internal ADC clock rate (F_{ADC}) between 2.0 GSPS to 3.2 GSPS. The clock signal can originate from an external clock source or, alternatively, from its on-chip clock synthesizer. Consider an external clock source if the on-chip synthesizer phase noise or spurious level is not deemed sufficient or if the desired F_{ADC} falls below the 2.94 GHz to 3.2 GHz range of the VCO. Referring to Figure 60, the self-biased clock receiver is configured as either a differential or single-ended receiver, depending on whether the clock synthesizer is disabled. In either case, the external clock source must be ac coupled to the AD6676 CLK_{\pm} input and meet the minimum specified input level and slew rate. Also, clock jitter and phase noise must always be a concern in selecting the clock source.

When the clock synthesizer is enabled, the CLK_{\pm} inputs are connected to CMOS inverters as shown in Figure 60. These inverters are self-biased at approximately 0.55 V and present an input resistance exceeding 1.2 k Ω when Bit 2 of Register 0x2BB is set.

A single-ended clock source need only be ac coupled to the CLK+ input because the inverter output for CLK- input is not used. For CMOS drivers, the addition of a 33 Ω series resistor is recommended to dampen the response for long trace lengths. For a differential clock source, such as an LVDS or PECL source, the addition of a 100 Ω external termination resistor across the CLK± pins is recommended to minimize any reflections that result from distorting the clock input waveform.

When the clock synthesizer is disabled, the CLK± inputs are connected to a high speed differential clock receiver with on-chip 100 Ω termination to simplify interfacing to CML, LVPECL, or sinusoidal clock sources. The clock signal is typically ac-coupled to the CLK+ and CLK- pins via an RF balun or capacitors. These pins are biased internally (see Figure 60) at approximately 700 mV and require no external bias. The equivalent shunt impedance of the CLK± input is shown in Figure 131. It is recommended to use a 100 Ω differential transmission line to route the clock signal to the CLK+ and CLK- pins due to the high frequency nature of the signal.

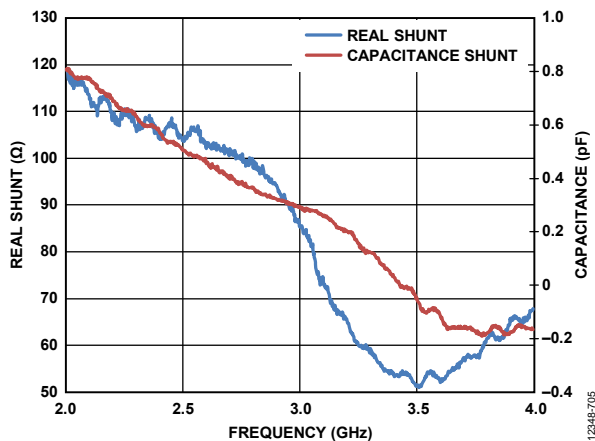

Figure 131. Equivalent Shunt Differential Input Impedance of the CLK± Pins with the Clock Synthesizer Disabled

Figure 132 shows a single-ended clock solution for the AD6676 when its clock synthesizer is disabled. The low phase noise single-ended source can be from an external VCXO. A ceramic RF chip 1:2 ratio balun creates the differential clock input signal. The balun must be specified to have low loss (that is, less than 2 dB) at the clock frequency of interest. The single-ended clock source must be capable of 0 dBm drive capability to ensure adequate signal swing into the clock input.

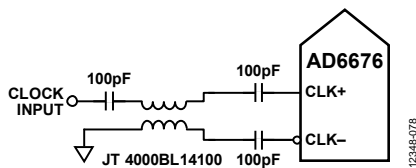

Figure 132. Balun Coupled Differential Clock

A single-ended CMOS or differential ac-coupled PECL/HSTL clock signal can be delivered via clock generation and distribution ICs such as the Analog Devices HMC7044, AD9528, and ADCLK925. A PECL clock signal is recommended when providing an RF clock input signal to the AD6676 or in applications that require deterministic latency or synchronization while using the internal clock synthesizer of the AD6676. Figure 133 shows a simple differential interface in which the AD6676 interfaces to the PECL output available from these ICs. The HMC7044 is an excellent choice for JESD204B clock generation and multichip synchronization because it also generates a very low phase noise RF clock from 2.4 GHz to 3.2 GHz for multiple AD6676 devices.

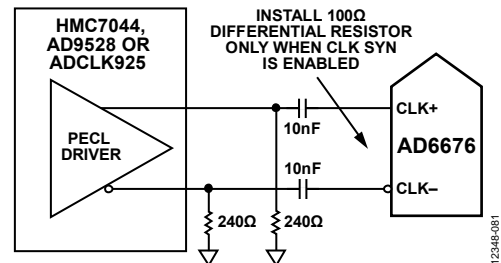

Figure 133. Differential PECL Sample Clock Using the HMC7044, AD9528, and ADCLK925

Alternatively, PLL clock synthesizers with on-chip VCOs such as the ADF4351, the ADF4355-2, and HMC1034 also make excellent RF clock sources when multichip synchronization is not required. The CML outputs of these devices allow a simple interface as shown in Figure 134. Figure 135 compares the close in phase noise between the ADF4351, the ADF4355-2, the HMC7044, the AD6676 clock synthesizer, and the R&S SMA100A for a near full-scale sine wave at 300 MHz. Note that the phase noise improvement offered by the high quality RF generator only becomes evident below 400 kHz when compared to the ADF4351.

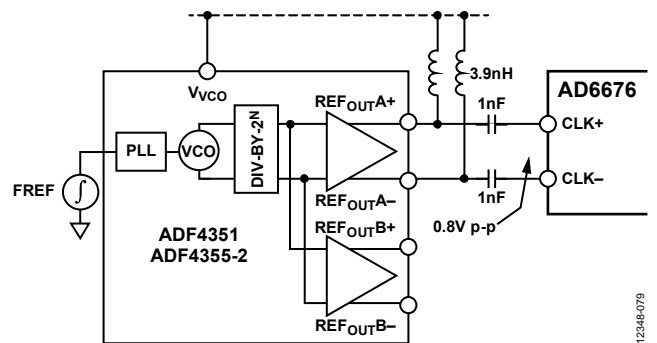

Figure 134. Differential CML Driver from the ADF4351 and the ADF4355-2

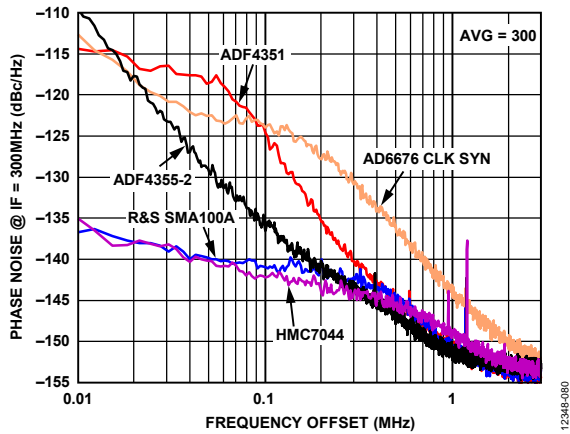

Figure 135. Close In Phase Noise Comparison for Different Analog Devices Clock Sources when Compared to the R&S SMA100A and the AD6676 Clock Synthesizer (IF = 300 MHz, BW = 40 MHz, F_{ADC} = 3.2 GHz, L = 19 nH)

IF FREQUENCY PLANNING

The Σ-Δ ADC can achieve exceptional SFDR performance over a wide IF frequency range because its high oversampling ratio prevents low order harmonics from aliasing into the IF pass band. Higher order harmonics that do alias back are typically of much lower magnitude, with the shuffling option further reducing their levels. However, finite isolation between the Σ-Δ ADC and the digital block causes additional spurious signals that are a function of the output data rate, f_{DATA_IQ}, and input frequency, f_{IN}. Specifically, the feedback DACs in the Σ-Δ ADC suffer from digital contamination of its clock signal. Therefore, the same equation used to predict spurious locations on high speed DACs with digital interpolation filters applies.

Equation 15 defines this relationship with the spur location falling at f_{MN}.

$$f_{MN} = \pm(M \times f_{DATA_IQ}) \pm (N \times f_{IN}) \tag{15}$$

where:

M is the digital induced harmonic content from internal clocks.
 N is the harmonics from the Σ-Δ ADC.

When N = 0, signal independent spurs fall at integer multiples of f_{DATA_IQ}. Table 23 shows the measured M × f_{DATA_IQ} spurious levels (dBFS) for different IF frequencies and decimation factors with f_{DATA_IQ} equal to 100 MSPS and 200 MSPS. All of the M × f_{DATA_IQ} regions display low spurious with the exception of 200 MHz. This is because a large portion of digital circuitry is clocked at F_{ADC}/16 for DEC_MODES of 1 and 3 or F_{ADC}/12 for DEC_MODES of 2 and 4. As a result, the M = 2 spur is dominant when operating at the higher decimation factors of 32 and 24 whereas the M = 1 spur is dominant when operating at the lower decimation factors of 16 and 12.

When N = 1, signal dependent spurs falls at integer multiples of f_{DATA_IQ}. These M × N spurs are called images because they have a 1:1 relationship in amplitude and frequency with the input signal, f_{IN}. Note that the magnitude of some images can also vary slightly between power cycles, due to different phase relationships among internal clock dividers upon device initialization.

Figure 136 shows a normalized image graph (relative to f_{DATA_IQ}) showing the image location relative for a given input frequency.

When N > 1, spurious content is often at lower magnitude than other spurious thus often can be ignored. The exception is when f_{IN} falls below the IF pass band such that its lower order harmonics may fall within the pass band (that is, IF/2 and IF/3).

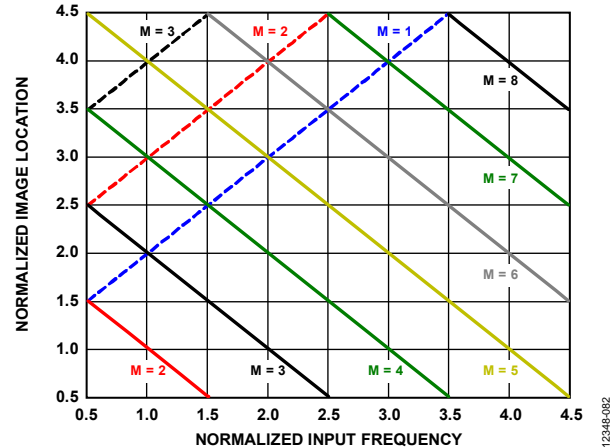

Figure 136. Image Location for Different M Factors Normalized to f_{DATA_IQ}

Table 23. Measured Spurious Levels at Different IFs Where M × f_{DATA_IQ} Falls On for f_{DATA_IQ} of 100 MSPS and 200 MSPS

f _{DATA_IQ}	Spurious Levels (dBFS)			
	IF = 100 MHz	IF = 200 MHz	IF = 300 MHz	IF = 400 MHz
100 MSPS				
DEC_MODE = 1	<-100	-81	<-110	-97
DEC_MODE = 2	-100	-79	<-110	N/A ¹
200 MSPS				
DEC_MODE = 3	<-110	-81	<-110	-90
DEC_MODE = 4	<-110	-77	<-110	N/A ¹

¹ N/A means not applicable.

Because the image spurs are also at low levels, the AD6676 offers a wide range of suitable IFs for a given output data rate, f_{DATA_IQ}. Even IFs that are situated in a region where the worst M × f_{DATA_IQ} spurious condition described in Table 23 can be used because they remain at a fixed location and remain signal independent. Similar to the LO feedthrough issue in a direct conversion IQ receiver, a slow digital tracking loop in the host processor can be used to nullify it. Figure 137 and Figure 138 show a case where the IF of 200 MHz was selected for an f_{DATA_IQ} of 200 MSPS and 100 MSPS such that dominant spur falls exactly at the IF center. As shown in Figure 136, the IF is positioned at a normalized f_{DATA_IQ} of 1 or 2 for 200 MSPS and 100 MSPS operation, thus explaining why the image term is M = 2 or 4. Note that the image spur is quite low for M = 2 and can be further improved by selecting a higher decimation factor (DEC_MODE of 3 vs. 1) that results in the M = 4 image.

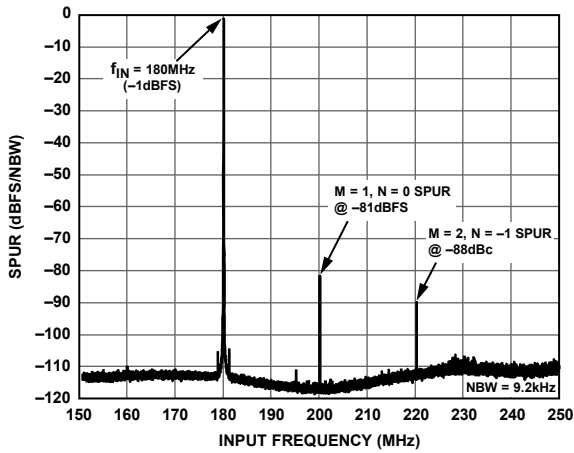

Figure 137. Image Spur for $f_{DATA_IQ} = 200$ MSPS (DEC_MODE = 3) Attributed to $M = 2, N = -1$

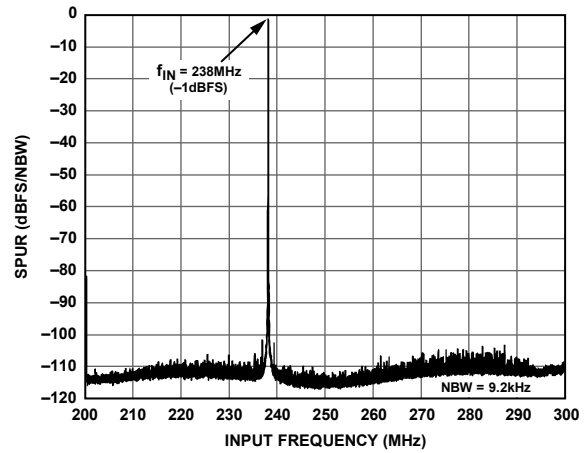

Figure 139. Digital Induced Spurs for an IF That Is Centered Between f_{DATA_IQ} and $1.5 \times f_{DATA_IQ}$ with $f_{DATA_IQ} = 200$ MSPS

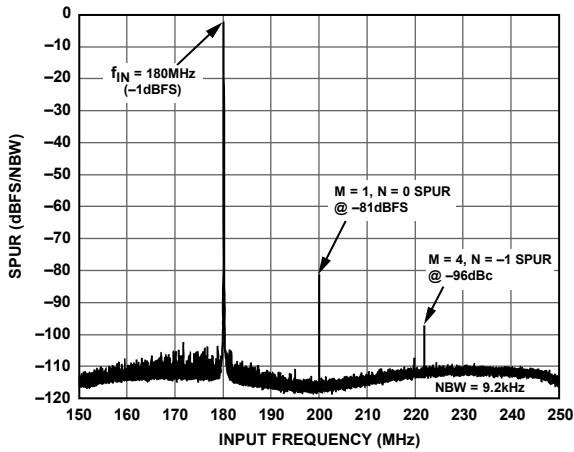

Figure 138. Reduction in Image Spur When f_{DATA_IQ} is Reduced to 100 MSPS

IF pass band regions that remain free of any of these spurs exist in the following regions for a swept input tone across its pass band:

$$(M - 0.5) \times f_{DATA_IQ} < IF \text{ Pass Band} < M \times f_{DATA_IQ} \quad (16)$$

Or

$$M \times f_{DATA_IQ} < IF \text{ Pass Band} < (M + 0.5) \times f_{DATA_IQ} \quad (17)$$

Note that because these spur free regions have a bandwidth of $0.5 \times f_{DATA_IQ}$, it is often desirable to use a higher f_{DATA_IQ} rate (that is, lower decimation factor) to support larger IF bands. Figure 139 shows a spur free region swept SFDR less than -95 dBFS with $f_{DATA_IQ} = 200$ MSPS and $BW = 100$ MHz with the IF now centered at 250 MHz. Selecting an IF situated at 350 MHz and $BW = 100$ MHz also produces similar results.

PCB DESIGN GUIDELINES

The design of the PCB is critical in achieving the full performance of the AD6676. The AD6676EBZ evaluation board, used for characterizing the AD6676 ac performance, serves as an example of a possible layout that uses 0.1 mm (4 mil) through-hole vias under the device. Figure 140 shows the top side PCB layout of the region surrounding the AD6676 where all the critical analog input/ outputs, digital input/outputs, and passive components reside. An alternative top side layout is shown in Figure 141 that avoids any through-hole vias under the device. Because this modified layout resulted in only a slight degradation in IMD performance, consider this layout option if via placement under the device is not possible.

Note the following:

- The PCB is a 6-layer board (1.6 mm thick) based on FR4 dielectric that avoids any expensive options, such as micro, hidden or blind vias, thus allowing cost effective manufacturing.
- Critical analog and digital high speed signal paths are routed on the first layer with controlled impedances. The lower speed CMOS digital input/outputs are placed on the back side sixth layer.
- A single solid ground plane is used as the second layer underneath the AD6676. The dielectric spacing is 8 mil to establish controlled impedances with the critical signal layer above.
The third and fourth layers are dedicated power planes used to isolate the different AD6676 supply domains, and the fifth layer is a solid ground plane. The dielectric spacing between the second and third layer and the fourth and fifth layer is 3 mil to increase the distributed decoupling capacitance for each supply domain.
- Special consideration was given to via placement, ground fill, and power supply plane layout to main low thermal and electrical impedances.

- All critical passive components, such as dc blocking and power supply decoupling capacitors, are 0201 size and placed on top side of the PCB. Two 0201 decoupling capacitors (0.001 μ F and 0.1 μ F) are placed adjacent to supply pins with the lower value placed closer to the [AD6676](#).
- The analog 1.1 V supply pins of the [AD6676](#) share a common 1.1 V supply domain and are tied together below the device.
- VSS2OUT (Pin G7) must be connected to VSS2IN (Pin F6) on the top side layer of the PCB.
- The alternative layout shown in Figure 141 uses 0.2 mm through-hole vias just outside of the [AD6676](#) package for all supply and ground domains with all of the 1.1 V analog supply domains (VDD1, VDDL, VDDC, and VDDQ) connected to each other providing a low impedance path to the critical inner VDD1 and VDDL balls. This alternative layout also avoids any narrow signal traces to inner row balls (with exception of CSB) by using a 3-wire SPI interface (with the SDIO, RESETB, AGC4, and AGC3 balls left open). Note that the thin inner trace for CSB (positioned between the SCLK and SYNCINB⁻ balls) could have been avoided by running a wider straight trace instead of connecting the CSB and SYNCINB⁻ balls because, by default, the SYNCINB⁻ input is configured for a CMOS input with only SYNCINB⁺ used for signaling (and SYNCINB⁻ ignored).

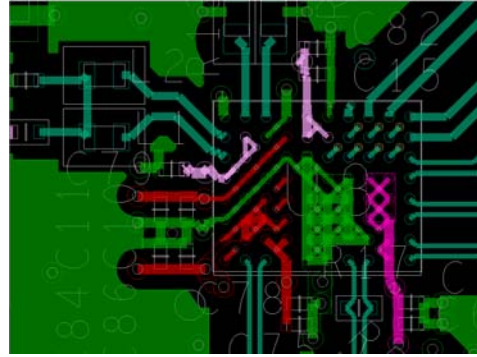

Figure 140. [AD6676EBZ](#) PCB Top Side Layout Example

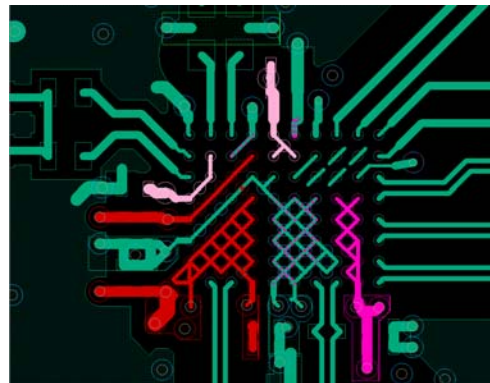

Figure 141. Alternative PCB Top Side Layout Example That Avoids a Through Hole Via under the Device

Additional information specifically pertaining to the WLCSP package considerations is contained in the [AN-617 Application Note](#). This application note covers PCB design guidelines, assembly, reliability, and rework in detail.

POWERING THE AD6676

The AD6676 requires the following analog and digital power supplies with no restrictions on the power supply sequencing order:

- An analog 2.5 V and 1.1 V supply
- A digital 1.1 V and digital input/output supply of 1.8 V to 2.5 V

The current consumption from the different analog and digital supply domains does not vary much over the specified 2.0 GHz to 3.2 GHz ADC clock rate range nor the digital decimation factor and number of JESD204B lanes used. Table 24 shows the dependency of a typical device as these settings are modified with the IF and BW remaining fixed at 250 MHz and 75 MHz, respectively.

Figure 142 shows the recommended method used on the AD6676EBZ where a universal 3.3 V supply is available. Note that various analog and digital supply domains within the AD6676 are grouped together to reduce the external LDO requirements. A high efficiency step-down regulator, such as the ADP2164, is used to generate a 1.6 V output that drives separate low drop-out LDOs for the analog VDD1 and digital VDDD supplies.

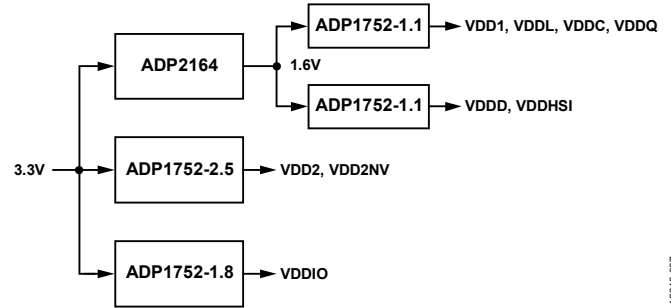

Figure 142. Low Noise Power Solution for the AD6676

Separate LDOs for the 1.1 V analog and digital supplies provide greater isolation between these critical supply domains as well as reduce the IR drops across ferrite beads that provide further isolation. High quality LDOs that exhibit better PSSR characteristics at the switching regulators operating frequency are preferable. Note that the digital VDDIO supply of the AD6676 is only used for the CMOS SPI and AGCx input/output pins thus it can be tied to the same supply domain used by the host that is connected to these pins. Alternatively, the ADP223 dual output LDO can be used instead of the ADP1752-2.5 and ADP1752-1.8.

On the analog 1.1 V supply, amplitude modulation can result in phase modulation via the clock supplies of the AD6676 (VDDC, VDDQ).

Table 24. Current Consumption Variation as F_{ADC} Is Varied from 3.2 GHz to 2.0 GHz

Supply Current	Conditions	f _{clk}				Unit
		3.2 GHz	2.8 GHz	2.4 GHz	2.0 GHz	
I _{VDD1} + I _{VDDL}	Not applicable	371	364	357	351	mA
I _{VDDC} + I _{VDDQ}	Not applicable	60	59	56	52	mA
I _{VDD2} + I _{VDD2NV}	Not applicable	143	140	139	139	mA
I _{VDDD}	Decimate by 16	152	144	131	100	mA
	Decimate by 32	155	150	135	106	mA
I _{VDDHSI}	Two lane	168	168	168	158	mA
	One lane	166	167	167	161	mA

Figure 143 and Figure 144 show the measured sideband level in dBc that results if a 1 mV p-p continuous wave tone has frequencies common among switching regulators are injected onto the 1.1 V and 2.5 V analog supplies. Note that the sideband level increases at roughly 6 dB per octave in IF frequency for the 1.1 V supply domain case because the supply noise results in PM modulation that affects the clock jitter.

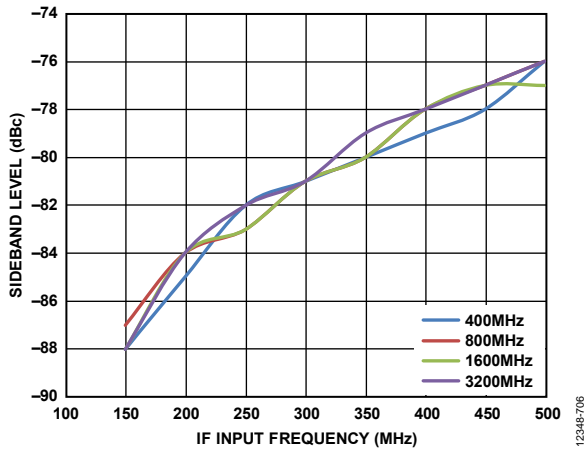

Figure 143. Sideband Spur Level for 1 mV p-p, Continuous Wave Tone Injected on Analog 1.1 V Supply Domain

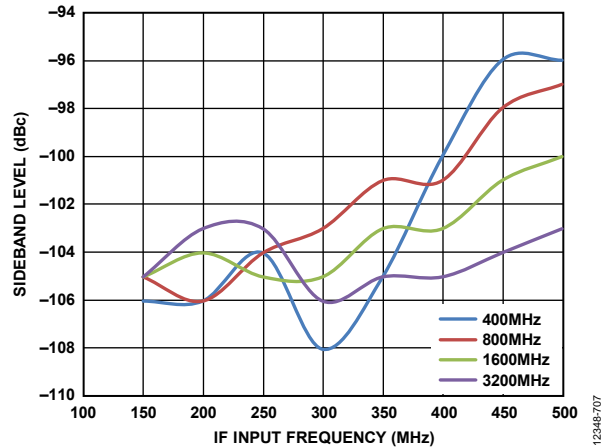

Figure 144. Sideband Spur Level for 1 mV p-p, Continuous Wave Tone Injected on Analog 2.5 V Supply Domain

On the digital 1.1 V supply, amplitude modulation on the JESD204B high speed serializer supply (VDDHSI) can negatively impact the eye opening of the digital data output stream. For these reasons, low noise LDOs, such as the [ADP1752](#), that have a worst-case accuracy of 2% over line, load, and temperature are used for the analog VDD2 and VDD1 supplies. The same regulator is used for the digital VDDD for its low dropout characteristics, power supply rejection ratio, and load capability. Although the digital VDDD is used for the less critical VDDIO supply, a smaller, lower cost regulator such as the [ADP121](#), can also be used to supply 1.8 V.

AD6676 START-UP INITIALIZATION

On power-up of the AD6676, a host processor is required to initialize and configure the AD6676 via its SPI port. Figure 145 shows a flowchart of the sequential steps required to bring the AD6676 to an operational state. The number of SPI writes and total initialization time is dependent on whether the clock synthesizer is used, as well as any additional configuration associated with the AGC features or its pin configurations. Note that wait states are required during different steps in the initialization process to allow various actions, such as calibration and tuning, to be completed before moving to the next step.

Table 26 shows the minimum SPI writes required to enable the AD6676. Note the following in the sequence of steps shown in Table 26:

- The example SPI writes pertain to the following settings: $F_{ADC} = 3.200\text{ GHz}$, $F_0 = 250\text{ MHz}$, $BW = 100\text{ MHz}$, $IDAC1_{FS} = 2\text{ mA}$, $MRGN_L = MRGN_U = 10\text{ MHz}$, $MRGN_IF = 1\text{ MHz}$, $f_{DATA_IQ} = 200\text{ MSPS}$ with decimate by 16, and $f_{REF} = 200\text{ MHz}$ with the clock synthesizer enabled.
- Step 3 refers to Table 28 for the necessary SPI writes when the clock synthesizer is enabled or disabled, respectively. Example AGC parameters are included in Table 29 but are nonessential to device operation.
- The RESON1 calibration for the ADC occurs first with default DEC_MODE setting. DEC_MODE is updated to the user specified setting prior to JESD204B calibration.
- ADC and JESD204B calibration and initialization must be successful on first attempt. However, Step 24 and Step 30 are included to provide coverage against external events (supply or clock glitch) that can corrupt this process.

The AD6676EVB software GUI has an option that automatically generates and saves the series of SPI writes in the .csv file format, as shown in Table 25, which is the preferred method for generating the AD6676 SPI write initialization sequence. Note the following:

- The SPI sequence can be shorter when the AD6676EVB development platform is connected to the PC because the software also performs a SPI read back and then only writes to those SPI registers that have been changed from its default setting.
- To generate a SPI initialization sequence for an alternative development platform, ensure that the AD6676EVB development platform is disconnected from the PC
- When the software GUI is configured for the profile feature, Register 0x115 and Register 0x118 specify the calibration and ADC profile, respectively, that pertain to the specific ADC application parameter settings in Register 0x100 thru Register 0x109 that follow. A SPI write of 0x01 to Register 0x116 follows to initiate the ADC tuning. This process repeats itself for the remaining specified profiles.

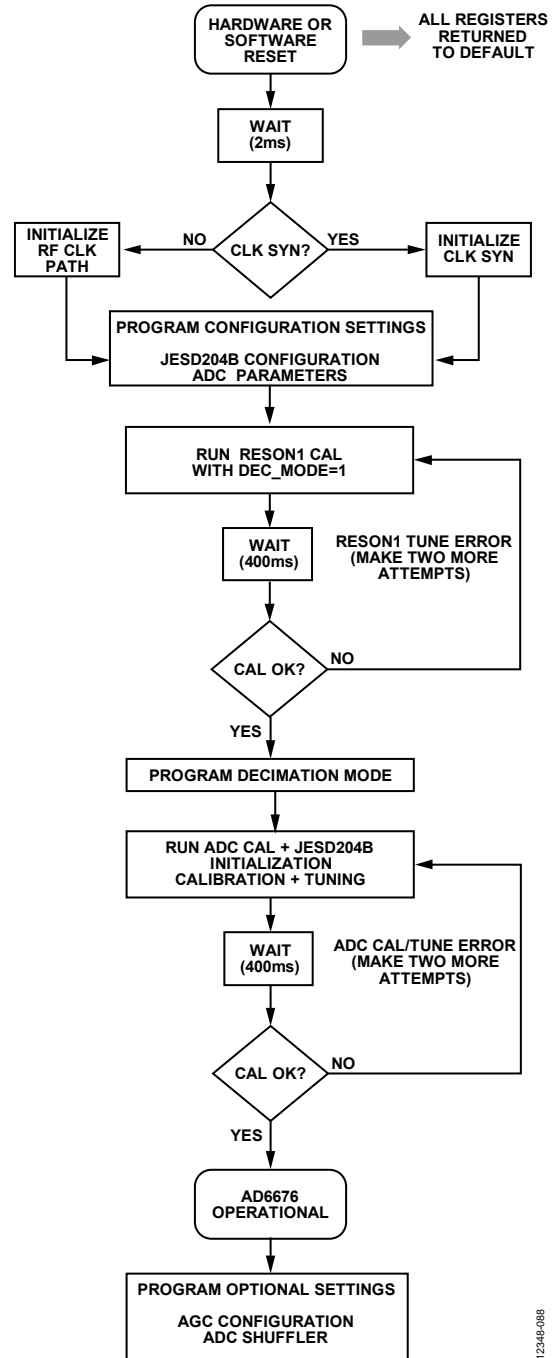

Figure 145. Flowchart for Initialization and Configuration of the AD6676

Table 25. Example of Saved .CSV File Format

Register Address	Write
0x000	0x99
0x2A5	0x05
0x2A0	0xC0
...	...
...	...

Table 26. SPI Initialization Example, $f_{CLK} = 3.2$ GHz, $F_{IF} = 250$ MHz, $BW = 100$ MHz, $IDAC1_{FS} = 2$ mA, $MRGN_L = MRGN_U = 10$ MHz, $MRGN_IF = 1$ MHz, $f_{DATA_IQ} = 200$ MSPS with Decimate by 16

Step	Address (Hex) ¹	Write Value ¹	Comments
1	0x000	0x99	Software reset, 4-wire SPI.
2			Wait 2 ms for SPI initialization after reset.
3			CLK path or CLK SYN initialization (see Table 28 for using external RF clock; refer to Table 27 for using internal CLK SYN.)
4	0x1E7	0x04	Select LVDS input for SYNCINB receiver.
5	0x1C0	0x01	JESD204 (DID = 1, optional).
6	0x1C1	0x05	JESD204 (BID = 5, optional).
7	0x1C3	0x01	JESD204B (SCR = 0, L = 2).
8	0x1C4	0x01	JESD204B (F = 2).
9	0x1C5	0x0F	JESD204B (K = 16).
10	0x1EC	0xBD	Configure PHY output driver.
11	0x100	0x80	Set F_{ADC} to 3200 MHz.
12	0x101	0x0C	Set F_{ADC} to 3200 MHz.
13	0x102	0xFA	Set the IF to 250 MHz.
14	0x103	0x00	Set the IF to 250 MHz.
15	0x104	0x64	Set the BW_0 to 100 MHz.
16	0x105	0x00	Set the BW_1 to 0 MHz.
17	0x106	0x13	Set L_{EXT} to 19 nH.
18	0x107	0x0a	Set $MRGN_L$ to 10 MHz.
19	0x108	0x0a	Set $MRGN_U$ to 10 MHz.
20	0x109	0x01	Set $MRGN_IF$ to 1 MHz.
21	0x10A	0x20	Set $IDAC1_{FS}$ to 2 mA, resulting in $PIN_0dBFS = -8$ dBm.
22	0x116	0x0A	Initiate RESON1 calibration.
23			Wait 250 ms for $f_{CLK} = 3.2$ GHz. Note that the wait time scales with f_{CLK} proportionally such that the wait = 400 ms for $f_{CLK} = 2$ GHz.
24			Read back Register 0x117 to see if Bit 0 has been set to 1 indicating ADC calibration is complete. If not, proceed to Step 25.
25	0x11A	0x01	Force end of calibration (toggle Bit 0).
	0x11A	0x00	Force end of calibration (toggle Bit 0).
26			Return to Step 22 and attempt again. Make two attempts before breaking out of loop if the calibration problem persists.
27	0x140	0x03	Set DEC_MODE to user defined setting of decimate by 16. Note that coarse and fine NCO settings (SPI Register 0x141 and SPI Register 0x142) are automatically set based on F_{ADC} and IF settings (Register 0x100 to Register 0x103).
28	0x116	0x17	Calibrate and initiate ADC; set-up and initiate JESD204B.
29			Wait 250 ms for $f_{CLK} = 3.2$ GHz. Note that wait time scales with f_{CLK} proportionally such that the wait = 400 ms for $f_{CLK} = 2$ GHz.
30			Read back Register 0x117 to see if Bit 0 has been set to 1 indicating ADC calibration is complete. If not, proceed to Step 31.
31	0x11A	0x01	Force end of calibration (toggle Bit 0).
	0x11A	0x00	Force end of calibration (toggle Bit 0).
32			Return to Step 28 and attempt again. Make two attempts before breaking out of loop if the calibration problem persists.
33			Insert the optional AGC and nondefault shuffler settings (see Table 29 and Table 30 for an example).

¹ Cells in the Address (Hex) column and Write Value column were left intentionally blank.

Table 27. SPI CLK SYN Initialization Example, $f_{CLK} = 2.94912$ GHz, $f_{REF} = 122.88$ MHz (Suitable for Decimation by 24)

Step	Address (Hex) ¹	Write Value ¹	Comments
1	0x2A1	0x60	Set the integer-N value.
2	0x2A2	0x00	Set the integer-N value.
3	0x2A5	0x08	Reset VCO calibration.
4	0x2AC	0x18	Set the charge pump current (see Table 12).
5	0x2B7	0xF0	Configure VCO.
6	0x2BB	0x7D	Set the reference divider to $DIV = 2$, such that $f_{PFD} = 61.44$ MHz (see Table 11).
7	0x2A0	0x7D	Enable CLKSYN and the ADC clock.
8	0x2AB	0xC5	Start VCO calibration.
9			Wait at least 400 ns because $f_{PFD} = 50$ MHz. Register 0x2BC, Bit 1 = 0 indicates that VCO calibration is done.
10	0x2AD	0x80	Start charge pump calibration. Wait at least 800 ns because $f_{PFD} = 50$ MHz. Register 0x2BC, Bit 0 = 1 indicates that the charge pump is done. Register 0x2BC, Bit 3 = 1 confirms that the PLL is locked.

¹ Cells in the Address (Hex) column and Write Value column were left intentionally blank.

Table 28. SPI f_{CLK} Initialization

Step	Address	Write Value	Comments
1	0x2A5	0x05	Select RF clock path
2	0x2A0	0xC0	Enable RF clock receiver and ADC clock

Table 29. SPI AGC Initialization Example

Step	Address	Write Value	Comments
1	0x181	0x00	Set ATTN_VALUE_PIN0 to 0 dB.
2	0x182	0x06	Set ATTN_VALUE_PIN1 to 6 dB.
3	0x19E	0x13	Enable FLAG1 and 0 on AGC4 and AGC3 pins, respectively. Also, logical OR of ADC reset with a peak detect threshold flag.
4	0x19B	0x04	Select AGC Flag 0 above Peak Threshold 0.
5	0x19C	0x06	Select AGC Flag 1 below low threshold.
6	0x193	0x00	Peak Threshold 0 set to -3 dBFS.
7	0x194	0x0d	Peak Threshold 0 set to -3 dBFS.
8	0x197	0x00	Low Threshold set to -15 dBFS.
9	0x198	0x09	Low Threshold set to -15 dBFS.
10	0x199	0x01	Low threshold dwell time mantissa.
11	0x19A	0x02	Low threshold dwell time exponent.

Table 30. SPI Shuffler Initialization Example

Step	Address	Write Value	Comments
1	0x342	0x3F	Shuffle every two clock cycles with a threshold of 3.
2	0x343	0xFF	

SERIAL PORT INTERFACE (SPI)

SPI REGISTER MAP DESCRIPTION

The AD6676 contains a set of programmable registers (described in the Register Memory Map section) that initialize and configure the device for its intended application. Note the following points when programming the AD6676 SPI registers:

- Registers pertaining to similar functions are typically grouped together and assigned adjacent addresses.
- Bits that are undefined within a register must be assigned a 0 when writing to that register.
- Do not write to registers that are undefined.
- A hardware or software reset is recommended on power-up to place SPI registers in a known state.

A SPI initialization routine is required as part of the boot process. See Table 26 for an example procedure.

Reset

Issuing a hardware or software reset places the AD6676 SPI registers in a known state. Both types of resets are similar in that they place SPI registers to their default states as described in Table 32, with the notable exception that a software reset does not affect Register 0x000. A hardware reset can be issued from a host or external supervisory IC by applying a low pulse with a minimum width of 40 ns to the RESETB pin (Pin G6). RESETB can also be kept left open if unused because it has an internal pull-up resistor. After issuing a reset, the SPI initialization process need only write to registers that are required for the boot process as well as any other register settings that must be modified, depending on the target application.

Although the AD6676 does feature an internal power on reset (POR), it is still recommended that a software or hardware reset be implemented shortly after power-up. The internal reset signal is derived from a logical OR operation from the internal POR signal, the RESETB pin, and the software reset state. A self-clearing software reset can be issued via the reset bit (Register 0x00, Bit 7). It is also recommended that the bit settings for Bits[7:4] be mirrored onto Bits[3:0] for the instruction cycle that issues a software reset.

Table 31. SPI Registers Pertaining to SPI Options

Address (Hex)	Bit	Description
0x000	7	Software reset SPI
	6	Enable SPI LSB first
	4	Enable 4-wire

SPI OPERATION

The serial port of the AD6676 shown in Figure 146 has a 3- or 4-wire SPI capability, allowing read/write access to all registers that configure the internal parameters of the device. It provides a flexible, synchronous serial communications port, allowing easy interface to most industry-standard FPGAs and microcontrollers. The 1.8 V to 2.5 V serial input/output is compatible with most synchronous transfer formats.

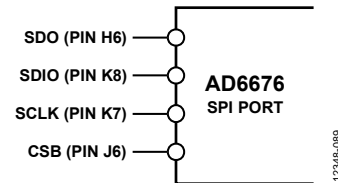

Figure 146. AD6676 SPI Port

The default 4-wire SPI interface consists of a clock (SCLK), serial port enable (CSB), serial data input (SDIO), and serial data output (SDO). The inputs to SCLK, CSB, and SDIO contain a Schmitt trigger centered about VDDIO/2. The maximum frequency for SCLK is 40 MHz. The SDO pin is active only during the transmission of data and remains three-stated at any other time.

A 3-wire SPI interface can be enabled by clearing the SDIO_DIR bit (Register 0x000, Bit 4). This causes the SDIO pin to become bidirectional such that output data only appears on the SDIO pin during a read operation. The SDO pin remains three-stated in a 3-wire SPI interface.

Instruction Header Information

MSB						LSB	
I_15	I_14	I_13	I_12	I_01	I_00
R/W	A14	A13	A12	A1	A0

A 16-bit instruction header must accompany each read and write operation. The MSB is a R/W indicator bit with logic high indicating a read operation. The remaining 15 bits specify the address bits to be accessed during the data transfer portion. The eight data bits immediately follow the instruction header for both read and write operations. For write operations, registers change immediately on writing to the last bit of each transfer byte.

The AD6676 serial port can support both most significant bit (MSB) first and least significant bit (LSB) first data formats. Figure 147 illustrates how the serial port words are formed for the MSB first and LSB first modes. The bit order is controlled by the LSB_FIRST bit (Register 0x000, Bit 6). The default value is 0, MSB first. When the LSB_FIRST bit is set high, the serial port interprets both instruction and data byte LSBs first.

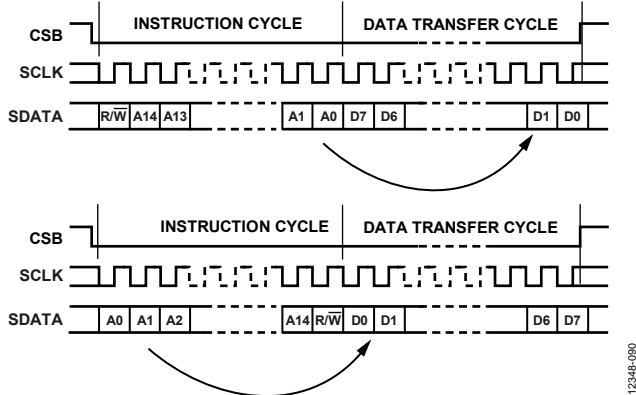

Figure 147. SPI Timing, MSB First (Upper) and LSB First (Lower)

Figure 148 illustrates the timing requirements for a write operation to the SPI port. After the serial port enable (CSB) signal goes low, data (SDIO) pertaining to the instruction header is read on the rising edges of the clock (SCLK). To initiate a write operation, the read/not write bit is set low. After the instruction header is read, the eight data bits pertaining to

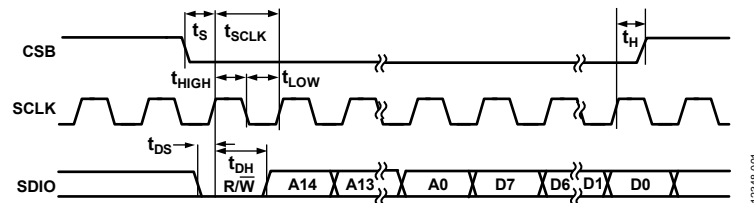

Figure 148. SPI Write Operation Timing

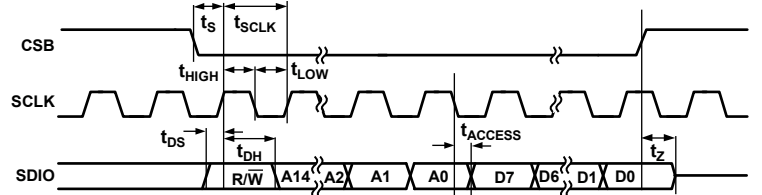

Figure 149. SPI 3-Wire Read Operation Timing

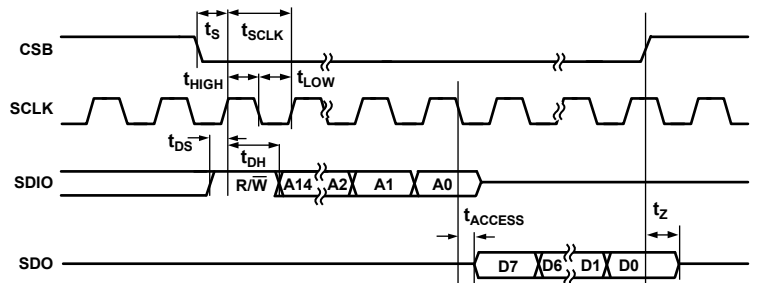

Figure 150. SPI 4-Wire Read Operation Timing

the specified register are shifted into the SDIO pin on the rising edge of the next eight clock cycles.

Figure 149 illustrates the timing for a 3-wire read operation to the SPI port. After CSB goes low, data (SDIO) pertaining to the instruction header is read on the rising edges of SCLK. A read operation occurs if the read/not write indicator is set high. After the address bits of the instruction header are read, the eight data bits pertaining to the specified register are shifted out of the SDIO pin on the falling edges of the next eight clock cycles.

Figure 150 illustrates the timing for a 4-wire read operation to the SPI port. The timing is similar to the 3-wire read operation with the exception that data appears at the SDO pin only, whereas the SDIO pin remains at high impedance throughout the operation. The SDO pin is an active output only during the data transfer phase and remains three-stated at all other times.

Lastly, the SPI port must not be active during periods when the full dynamic performance of the converter is required. Because the SCLK, CSB, and SDIO signals are typically asynchronous to the ADC clock, noise from these signals can degrade converter performance. If the on-board SPI bus is used for other devices, it may be necessary to provide buffers between this bus and the AD6676 to keep these signals from transitioning at the converter input pins and causing unwanted spurious signals.

REGISTER MEMORY MAP AND DETAILS

REGISTER MEMORY MAP

Note that all address and bit locations that are not included in Table 32 are not currently supported for this device.

Table 32. Register Summary

Reg	Name	Bit 7	Bit 6	Bit 5	Bit 4	Bit 3	Bit 2	Bit 1	Bit 0	Reset	RW	
0x000	SPI_CONFIG	SW_RESET	LSB_FIRST	RESERVED	SDIO_DIR	SDIO_DIR	RESERVED	LSB_FIRST	SW_RESET	0x18	RW	
0x002	DEVICE_CONFIG	RESERVED						PD_MODE			0x00	RW
0x003	CHIP_TYPE	RESERVED						CHIP_TYPE			0x03	R
0x004	CHIP_ID0	RESERVED						CHIP_ID0			0xBB	R
0x005	CHIP_ID1	RESERVED						CHIP_ID1			0x00	R
0x006	GRADE_REVISION	REVISION				GRADE				0x00	R	
0x00C	VENDOR_ID0	RESERVED						VENDOR_ID0			0x56	R
0x00D	VENDOR_ID1	RESERVED						VENDOR_ID1			0x04	R
BP Σ-Δ ADC Configuration Settings												
0x100	FADC_0	RESERVED						FADC_0			0x10	RW
0x101	FADC_1	RESERVED						FADC_1			0x0E	RW
0x102	FIF_0	RESERVED						FIF_0			0x2C	RW
0x103	FIF_1	RESERVED						FIF_1			0x01	RW
0x104	BW_0	RESERVED						BW_0			0x3C	RW
0x105	BW_1	RESERVED						BW_1			0x00	RW
0x106	LEXT	RESERVED						LEXT			0x14	RW
0x107	MRGN_L	RESERVED						MRGN_L			0x05	RW
0x108	MRGN_U	RESERVED						MRGN_U			0x05	RW
0x109	MRGN_IF	RESERVED						MRGN_IF			0x00	RW
0x10A	IDAC1_FS	RESERVED						IDAC1_FS			0x40	RW
BP Σ-Δ ADC Calibration/Profile												
0x115	CAL_CTRL	RESERVED						CAL_PROFILE			0x00	RW
0x116	CAL_CMD	RESERVED	INIT_NTF_OP	INIT_JESD	RESON1_CAL	FLASH_CAL	INIT_ADC	TUNE_ADC	0x00	RW		
0x117	CAL_DONE	RESERVED						CAL_DONE			0x00	RW
0x118	ADC_PROFILE	RESERVED						ADC_PROFILE			0x00	W
0x11A	FORCE_END_CAL	RESERVED						FORCE_END_CAL			0x00	RW
Digital Signal Path												
0x140	DEC_MODE	RESERVED						DEC_MODE			0x01	RW
0x141	MIX1_TUNING	RESERVED	MIX1_TUNING						0x05	RW		
0x142	MIX2_TUNING	MIX2_TUNING						0x15	RW			
0x143	MIX1_INIT	RESERVED	MIX1_INIT						0x00	RW		
0x144	MIX2_INIT_LSB	MIX2_INIT_LSB						0x00	RW			
0x145	MIX2_INIT_MSB	RESERVED						MIX2_INIT_MSB			0x00	RW
0x146	DP_CTRL	RESERVED						NOT_2S_COMPL			0x00	RW
Power Control												
0x150	STANDBY	RESERVED	STBY_VSS2GEN	STBY_CLK_PLL	STBY_JESD_PLL	STBY_JESD_PHY	STBY_FRAMER	STBY_DATAPATH	STBY_DIGCLK	0x02	RW	
0x151	PD_DIG	RESERVED						PD_FRAMER	PD_DATAPATH	PD_DIGCLK	0x00	RW
0x152	PD_PIN_CTRL	RESERVED				PD_PIN_EN	RESERVED		PD_PIN_SEL	0x00	RW	
0x250	STBY_DAC	STBY_DAC						0xFF	RW			
Attenuator												
0x180	ATTEN_MODE	RESERVED						ATTEN_MODE			0x00	RW
0x181	ATTEN_VALUE_PIN0	ATTEN_VALUE_PIN0						0x0C	RW			
0x182	ATTEN_VALUE_PIN1	ATTEN_VALUE_PIN1						0x0C	RW			
0x183	ATTEN_INIT	ATTEN_INIT						0x00	RW			
0x184	ATTEN_CTL	ATT_PIN	RESERVED			ATTEN_READ			0x0C	R		
ADC Reset Control												
0x188	ADCRE_THRH	RESERVED						ADCRE_THRH			0x05	RW
0x189	ADCRE_PULSE_LEN	RESERVED				ADCRE_PULSE_LEN				0x01	RW	
0x18A	ATTEN_STEP_RE	RESERVED				ATTEN_STEP_RE				0x06	RW	
Peak Detector and AGC Flag Control												
0x18F	ADC_UNSTABLE	RESERVED						CLEAR_UNSTABLE_FLAG	UNSTABLE_FLAG	0x00	RW	
0x193	PKTHRHO_LSB	PKTHRHO_LSB						0x00	RW			
0x194	PKTHRHO_MSB	RESERVED				PKTHRHO_MSB				0x00	RW	
0x195	PKTHRH1_LSB	PKTHRH1_LSB						0x00	RW			

Reg	Name	Bit 7	Bit 6	Bit 5	Bit 4	Bit 3	Bit 2	Bit 1	Bit 0	Reset	RW	
0x196	PKTHRH1_MSB	RESERVED				PKTHRH1_MSB				0x00	RW	
0x197	LOWTHRHR_LSB	RESERVED				LOWTHRHR_LSB				0x00	RW	
0x198	LOWTHRHR_MSB	RESERVED				LOWTHRHR_MSB				0x00	RW	
0x199	DWELL_TIME_MANTISSA	RESERVED				DWELL_TIME_MANTISSA				0x00	RW	
0x19A	DWELL_TIME_EXP	RESERVED				DWELL_TIME_EXP				0x00	RW	
0x19B	FLAG0_SEL	RESERVED				FLAG0_SEL				0x00	RW	
0x19C	FLAG1_SEL	RESERVED				FLAG1_SEL				0x00	RW	
0x19E	EN_FLAG	RESERVED			EN_OR	RESERVED		EN_FLAG1	EN_FLAG0	0x00	RW	
GPIO Configuration												
0x1B0	FORCE_GPIO	RESERVED				FORCE_GPIO				0x00	RW	
0x1B1	FORCE_GPIO_OUT	RESERVED				FORCE_GPIO_OUT				0x00	RW	
0x1B2	FORCE_GPIO_VAL	RESERVED				FORCE_GPIO_VAL				0x00	RW	
0x1B3	READ_GPO	RESERVED				READ_GPO				0x00	R	
0x1B4	READ_GPI	RESERVED				READ_GPI				0x00	R	
JESD204B Interface												
0x1C0	DID	RESERVED				DID				0x00	RW	
0x1C1	BID	RESERVED				BID				0x00	RW	
0x1C3	L	SCR	RESERVED			L				0x00	RW	
0x1C4	F	RESERVED				F				0x03	RW	
0x1C5	K	RESERVED				K				0x1F	RW	
0x1C6	M	RESERVED				M				0x01	RW	
0x1C9	S	RESERVED				S				0x00	RW	
0x1CB	RES1	RESERVED				RES1				0x00	RW	
0x1CC	RES2	RESERVED				RES2				0x00	RW	
0x1D0	LID0	RESERVED				LID0				0x00	RW	
0x1D1	LID1	RESERVED				LID1				0x01	RW	
0x1D8	FCHK0	RESERVED				FCHK0				0x44	RW	
0x1D9	FCHK1	RESERVED				FCHK1				0x45	RW	
0x1E0	EN_LFIFO	RESERVED							EN_LFIFO	0x00	RW	
0x1E1	SWAP	RESERVED		SWAP_CONV		RESERVED		SWAP_LANE		0x00	RW	
0x1E2	LANE_PD	ILAS_DELAY				RESERVED		LANE_PD		0x00	RW	
0x1E3	MIS1	RESERVED		TEST_SAMPLE_EN	LSYNC_EN	ILAS_MODE		FACI_DISABLE	RESERVED	0x14	RW	
0x1E4	SYNC_PIN	RESERVED		SYNC_PIN_INV	RESERVED			INV_10B	RESERVED	0x00	RW	
0x1E5	TEST_GEN	RESERVED		TEST_GEN_SEL		TEST_GEN_MODE				0x00	RW	
0x1E6	KF_ILAS	RESERVED				KF_ILAS				0x00	RW	
0x1E7	SYNCINB_CTRL	RESERVED				PD_SYSREF_RX	LVDS_SYNCINB	RESERVED			0x00	RW
0x1E8	MIX_CTRL	RESERVED	MIX_USE_2ND	MIX_NEXT	MIX_ALL	RESERVED	USE_2ND_SYSREF	NEXT_SYSREF	ALL_SYSREF	0x00	RW	
0x1E9	K_OFFSET	RESERVED				K_OFFSET				0x00	RW	
0x1EA	SYSREF	SYSREF_WIN_NEG				SYSREF_WIN_POS				0x00	RW	
0x1EB	SER1	SER_DRV_PS	RESERVED								0x1C	RW
0x1EC	SER2	SER_ITRIM				SER_RTRIM				0x9B	RW	
0x1EF	PRE-EMPHASIS	SER_EMP_PS1	SER_EMP_IDAC1			SER_EMP_PS0	SER_EMP_IDAC0				0x00	RW
ADC Clock Synthesizer												
0x2A0	CLKSYN_ENABLE	EN_EXTCK	EN_ADC_CK	EN_SYNTH	EN_VCO_PTAT	EN_VCO_ALC	EN_VCO	EN_OVERRIDE_CAL	EN_OVERRIDE	0x00	RW	
0x2A1	CLKSYN_INT_N_LSB	INT_N_LSB[7:0]								0x80	RW	
0x2A2	CLKSYN_INT_N_MSB	RESERVED				INT_N_MSB[10:8]				0x00	RW	
0x2A5	VCO_CAL_RESET	RESERVED				VCO_CAL_RESET	RESERVED				0x00	RW
0x2AA	CLKSYN_VCO_BIAS	RESERVED		BIAS_TEMPCO		RESERVED	BIAS				0x37	RW
0x2AB	CLKSYN_VCO_CAL	INIT_ALC_VALUE				ALC_DIS	RESERVED		ID_SYNTH	0xC0	RW	
0x2AC	CLKSYN_I_CP	RESERVED		I_CP						0x19	RW	
0x2AD	EN_CP_CAL	EN_CP_CAL		RESERVED						0x00		
0x2B7	CLKSYN_VCO_VAR	VCO_VAR				RESERVED				0xD0	RW	
0x2BB	CLKSYN_R_DIV	R_DIV		RESERVED		SYSREF_CTRL	CLKIN_IMP	RESERVED			0xB9	RW
0x2BC	CLKSYN_STATUS	RESERVED				PLL_LCK	RESERVED	VCO CAL BUSY	CP CAL DONE	0x80	R	
0x2DC	JESDSYN_STATUS	RESERVED				PLL_LCK	RESERVED	VCO CAL BUSY	CP CAL DONE	0x80	R	
ADC Adaptive Shuffler Control												
0x340	SHUFFLE_CTRL	RESERVED							EN_ADAPTIVE_SHUFFLE	0x03	RW	
0x342	SHUFFLE_THREG_0	SHUFFLE_TH2				SHUFFLE_TH1				0xF5	RW	
0x343	SHUFFLE_THREG_1	SHUFFLE_TH4				SHUFFLE_TH3				0xFF	RW	

REGISTER DETAILS***SPI Configuration Register***

Address: 0x000, Reset: 0x18, Name: SPI_CONFIG

Table 33. Bit Descriptions for SPI_CONFIG

Bits	Bit Name	Description	Reset	Access
7	SW_RESET	Self-clearing bit causing software reset when set. Software reset returns all SPI registers to default state.	0	RW
6	LSB_FIRST	When set, causes input and output data to be orientated as LSB first, per SPI standard.	0	
4	SDIO_DIR	When set, causes SPI interface to be 4-wire with output data appearing on the SDO pin.	1	

This register uses the first four bits to configure SPI interface/format thus Bit 0, Bit 1, and Bit 3 are mirror images of Bit 7, Bit 6, and Bit 4.

Device Configuration Register

Address: 0x002, Reset: 0x00, Name: DEVICE_CONFIG

Table 34. Bit Descriptions for DEVICE_CONFIG

Bits	Bit Name	Description	Reset	Access
[7:2]	RESERVED		0x0	RW
[1:0]	PD_MODE	Power-down/standby control 00 = normal operation 01 = not used. 10 = standby mode 11 = sleep (power-down) mode	0x0	RW

Chip Type Register

Address: 0x003, Reset: 0x03, Name: CHIP_TYPE

Table 35. Bit Descriptions for CHIP_TYPE

Bits	Bit Name	Description	Reset	Access
[7:0]	CHIP_TYPE	Chip Type: High Speed ADC.	0x03	R

Chip ID 0 Register

Address: 0x004, Reset: 0xBB, Name: CHIP_ID0

Table 36. Bit Descriptions for CHIP_ID0

Bits	Bit Name	Description	Reset	Access
[7:0]	CHIP_ID0	Chip ID Low Byte.	0xBB	R

Chip ID 1 Register

Address: 0x005, Reset: 0x00, Name: CHIP_ID1

Table 37. Bit Descriptions for CHIP_ID1

Bits	Bit Name	Description	Reset	Access
[7:0]	CHIP_ID1	Chip ID High Byte.	0x00	R

Chip Grade/Revision Register

Address: 0x006, Reset: 0x00, Name: GRADE_REVISION

Table 38. Bit Descriptions for GRADE_REVISION

Bits	Bit Name	Description	Reset	Access
[7:4]	REVISION		0x0	R
[3:0]	GRADE		0x0	R

Vendor ID 0 Register

Address: 0x00C, Reset: 0x56, Name: VENDOR_ID0

Table 39. Bit Descriptions for VENDOR_ID0

Bits	Bit Name	Description	Reset	Access
[7:0]	VENDOR_ID0		0x56	R

Vendor ID 1 Register

Address: 0x00D, Reset: 0x04, Name: VENDOR_ID1

Table 40. Bit Descriptions for VENDOR_ID1

Bits	Bit Name	Description	Reset	Access
[7:0]	VENDOR_ID1		0x04	R

ADC CLK Frequency LSB Register

Address: 0x100, Reset: 0x10, Name: FADC_0

Table 41. Bit Descriptions for FADC_0

Bits	Bit Name	Description	Reset	Access
[7:0]	FADC_0	Lower 8-bits of 16-bit value that defines the ADC CLK frequency to 1 MHz resolution. For example, the FADC_1 and FADC_0 settings for a 3200 MHz CLK frequency are 0x0C and 0x80, respectively.	0x10	RW

ADC CLK Frequency MSB Register 1

Address: 0x101, Reset: 0x0E, Name: FADC_1

Table 42. Bit Descriptions for FADC_1

Bits	Bit Name	Description	Reset	Access
[7:0]	FADC_1	Upper 8-bits of 16-bit value that defines the ADC CLK frequency to 1 MHz. For example, the FADC_1 and FADC_0 settings for a 3200 MHz CLK frequency are 0x0C and 0x80, respectively.	0x0E	RW

IF Frequency LSB Register 0

Address: 0x102, Reset: 0x2C, Name: FIF_0

Table 43. Bit Descriptions for FIF_0

Bits	Bit Name	Description	Reset	Access
[7:0]	FIF_0	Lower 8-bits of 16-bit value that defines the target IF frequency to 1 MHz resolution. For example, the FIF_1 and FIF_0 settings for a 300 MHz IF frequency are 0x01 and 0x2C, respectively.	0x2C	RW

IF Frequency MSB Register 1

Address: 0x103, Reset: 0x01, Name: FIF_1

Table 44. Bit Descriptions for F0_1

Bits	Bit Name	Description	Reset	Access
[7:0]	FIF_1	Upper 8-bits of 16-bit value that defines the target IF frequency to 1 MHz resolution. For example, the FIF_1 and FIF_0 settings for a 300 MHz IF frequency would be 0x01 and 0x2C, respectively.	0x01	RW

BW LSB Register 0

Address: 0x104, Reset: 0x3C, Name: BW_0

Table 45. Bit Descriptions for BW_0

Bits	Bit Name	Description	Reset	Access
[7:0]	BW_0	Lower 8-bits of 16-bit value that defines the target BW frequency to 1 MHz resolution. For example, the BW_1 and BW_0 settings for a 60 MHz BW would be 0x00 and 0x3C, respectively.	0x3C	RW

BW MSB Register 1

Address: 0x105, Reset: 0x00, Name: BW_1

Table 46. Bit Descriptions for BW_1

Bits	Bit Name	Description	Reset	Access
[7:0]	BW_1	Upper 8-bits of 16-bit value that defines the target BW frequency to 1 MHz resolution. This register should be kept to 0x00 default setting because maximum BW should be no greater than 160 MHz.	0x00	RW

External Inductance Value Register

Address: 0x106, Reset: 0x14, Name: LEXT

Table 47. Bit Descriptions for LEXT

Bits	Bit Name	Description	Reset	Access
[7:0]	LEXT	External inductance in nH. Enter the external inductance value for the LC tank resonator. The default value of 0x14 corresponds to 20 nH	0x14	RW

Bandwidth Margin (Low End) Register

Address: 0x107, Reset: 0x05, Name: MRGN_L

Table 48. Bit Descriptions for MRGN_L

Bits	Bit Name	Description	Reset	Access
[7:0]	MRGN_L	An 8-bit register defining the offset frequency (to 1 MHz resolution) to which the frequency of the lower resonator is offset from its theoretical ideal value. The default setting is 5 MHz. Increasing the value lowers the actual resonator frequency.	0x05	RW

Bandwidth Margin (Upper End) Register

Address: 0x108, Reset: 0x05, Name: MRGN_U

Table 49. Bit Descriptions for MRGN_U

Bits	Bit Name	Description	Reset	Access
[7:0]	MRGN_U	An 8-bit register defining the offset frequency (to 1 MHz resolution) to which the frequency of the upper resonator is offset from its theoretical ideal value. The default setting is 5 MHz. Increasing the value increases the actual resonator frequency.	0x05	RW

Bandwidth Margin (IF) Register

Address: 0x109, Reset: 0x00, Name: MRGN_IF

Table 50. Bit Descriptions for MRGN_IF

Bits	Bit Name	Description	Reset	Access
[7:0]	MRGN_IF	An 8-bit register defining the offset frequency (to 1 MHz resolution) to which the frequency of the LC resonator is offset from its theoretical ideal value. The default setting is 0 MHz. Increasing the value increases the actual resonator frequency.	0x00	RW

IDAC1_{FS} Gain Scaling Register

Address: 0x10A, Reset: 0x40, Name: IDAC1_FS

Table 51. Bit Descriptions for IDAC1_FS

Bits	Bit Name	Description	Reset	Access
[7:0]	IDAC1_FS	This parameter allows adjustment of the full-scale input power level of the ADC by adjusting the full-scale current of IDAC1. The nominal setting of 0x40 sets IDAC1 _{FS} value to 4 mA and corresponds to the largest full-scale level of approximately –3 dBm (with the IF attenuator set to 0 dB.) A setting of 0x20 or 0x10 results IDAC1 _{FS} value to 2 mA or 1 mA, thus resulting in a 6 dB or 12 dB reduction in PIN_0dBFS. Settings resulting in more than 12 dB reduction are not recommended.	0x40	RW

Calibration Control Register

Address: 0x115, Reset: 0x00, Name: CAL_CTRL

Table 52. Bit Descriptions for CAL_CTRL

Bits	Bit Name	Description	Reset	Access
[7:2]	RESERVED		0x00	RW
[1:0]	CAL_PROFILE	ADC profile to be calibrated. Select one of the four ADC profiles in which to store the results of the calibration. For example, to support multiple IF settings, the four profiles cover all registers in the range of 0x141 to 0x145.		RW

Calibration Command Register

Address: 0x116, Reset: 0x00, Name: CAL_CMD

Table 53. Bit Descriptions for CAL_CMD

Bits	Bit Name	Description	Reset	Access
[7:6]	RESERVED		0x0	RWAC
5	INIT_NTF_OP		0x0	RWAC
4	INIT_JESD		0x0	RWAC
3	RESON1_CAL		0x0	RWAC
2	FLASH_CAL		0x0	RWAC
1	INIT_ADC		0x0	RWAC
0	TUNE_ADC		0x0	RWAC

Setting a 1 in one or more of the bits in this register initiates the internal calibration. This register is cleared automatically at the end of calibration or by setting the FORCE_END_CAL bit.

Calibration Done Register

Address: 0x117, Reset: 0x00, Name: CAL_DONE

Table 54. Bit Descriptions for ADC_PROFILE

Bits	Bit Name	Description	Reset	Access
[7:1]	RESERVED		0x00	RW
[0]	CAL_DONE	This bit indicates that the microcontroller has completed its calibration. It is automatically cleared by a new CAL_CMD.	0x0	RW

ADC Profile Selection Register

Address: 0x118, Reset: 0x00, Name: ADC_PROFILE

Table 55. Bit Descriptions for ADC_PROFILE

Bits	Bit Name	Description	Reset	Access
[7:2]	RESERVED		0x00	W
[1:0]	ADC_PROFILE	ADC profile. Select which one of the four ADC profiles to use in operation. The user may switch between multiple profiles if calibration has taken place for each. Note that the four profiles also cover SPI Register 0x141 to SPI Register 0x145 if the digital mixer settings are varied between profiles.	0x0	W

Force End of Calibration Register

Address: 0x11A, Reset: 0x00, Name: FORCE_END_CAL

Table 56. Bit Descriptions for FORCE_END_CAL

Bits	Bit Name	Description	Reset	Access
[7:1]	RESERVED		0x00	RW
0	FORCE_END_CAL	Setting this bit high and then low (two write operations) allows the user to terminate the calibration and hand control back to the SPI. This SPI operation should only be performed if the AD6676 fails to clear Register 0x116 after 400 ms.	0x0	RW

This is a user accessible SPI register only when the controller is performing a calibration.

Decimation Mode Register

Address: 0x140, Reset: 0x01, Name: DEC_MODE

Table 57. Bit Descriptions for DEC_MODE

Bits	Bit Name	Settings	Description	Reset	Access
[7:3]	RESERVED			0x00	RW
[2:0]	DEC_MODE		Decimation Mode.	0x01	RW
		001	Decimate by 32.		
		010	Decimate by 24.		
		011	Decimate by 16.		
		100	Decimate by 12.		

Coarse NCO Tuning Register

Address: 0x141, Reset: 0x05, Name: MIX1_TUNING

Table 58. Bit Descriptions for MIX1_TUNING

Bits	Bit Name	Description	Reset	Access
[7:6]	RESERVED		0x0	RW
[5:0]	MIX1_TUNING	Mix1 Tuning. Coarse downconversion frequency, in units of $F_{ADC}/64$. For example, setting bits to 000011 downconverts by $F_{ADC} \times (3/64)$.	0x5	RW

This register has four copies, one for each of the ADC profiles. The default for Profile 0 is 0x05; the default for the other profiles is 0x00. At the default ADC clock rate of 3.2 GHz; the default Profile 0 downconversion frequency is $(5/64) \times 3.6 \text{ GHz} = 250 \text{ MHz}$

Fine NCO Tuning Register

Address: 0x142, Reset: 0x15, Name: MIX2_TUNING

Table 59. Bit Descriptions for MIX2_TUNING

Bits	Bit Name	Description	Reset	Access
[7:0]	MIX2_TUNING	Mix2 Tuning. Fine down/upconversion frequency. For decimation Mode 1 and Mode 3, this twos complement number represents steps of $F_{ADC}/4096$. For decimation Mode 2 and Mode 4, it represents steps of $F_{ADC}/3072$. A positive number is a downconversion; a negative number is an upconversion.	0x15	RW

This register has four copies, one for each of the ADC profiles. The default for Profile 0 is 0x21; the default for the other profiles is 0x00. At the default ADC clock rate of 3.2 GHz, the default Profile 0 downconversion frequency is $(33/4096) \times 3.2 \text{ GHz} = 25.78125 \text{ MHz}$

Coarse NCO Initial Phase Register

Address: 0x143, Reset: 0x00, Name: MIX1_INIT

Table 60. Bit Descriptions for MIX1_INIT

Bits	Bit Name	Description	Reset	Access
[7:6]	RESERVED		0x0	RW
[5:0]	MIX1_INIT	NCO1 Initial Phase. Initial phase of the coarse resolution NCO after synchronization with SYSREF, in units of 1/64 of a cycle.	0x00	RW

This register has four copies, one for each of the ADC profiles. The default for Profile 0 is 0x00.

Fine NCO Initial Phase LSB Register

Address: 0x144, Reset: 0x00, Name: MIX2_INIT_LSB

Table 61. Bit Descriptions for MIX2_INIT_LSB

Bits	Bit Name	Description	Reset	Access
[7:0]	MIX2_INIT_LSB	NCO2 Initial Phase. Initial phase of the fine resolution NCO after synchronization with SYSREF, in units of 1/1024 of a cycle. The two MSBs of the 10-bit value are in Register 0x145.	0x00	RW

This register has four copies, one for each of the ADC profiles. The default for Profile 0 is 0x00.

Fine NCO Initial Phase MSB Register

Address: 0x145, Reset: 0x00, Name: MIX2_INIT_MSB

Table 62. Bit Descriptions for MIX2_INIT_MSB

Bits	Bit Name	Description	Reset	Access
[7:2]	RESERVED		0x00	RW
[1:0]	MIX2_INIT_MSB	NCO2 Initial Phase. Initial phase of the fine resolution NCO after synchronization with SYSREF, in units of 1/1024 of a cycle. The LSBs of the 10-bit value are in Register 0x144.	0x0	RW

This register has four copies, one for each of the ADC profiles. The default for Profile 0 is 0x00.

Datapath Controls Register

Address: 0x146, Reset: 0x00, Name: DP_CTRL

Table 63. Bit Descriptions for DP_CTRL

Bits	Bit Name	Description	Reset	Access
[7:1]	RESERVED		0x00	RW
0	NOT_2S_COMPL	Output Data Format: twos complement = 0; straight binary = 1		

Standby Register

Address: 0x150, Reset: 0x02, Name: STANDBY

When bits in this register are set, the corresponding blocks enter a power-down state when the chip enters standby mode.

Table 64. Bit Descriptions for STANDBY

Bits	Bit Name	Description	Reset	Access
7	RESERVED		0x0	RW
6	STBY_VSS2GEN	1: power down negative supply (VSS2) generator during standby.	0x0	RW
5	STBY_CLK_PLL	1: power down main clock PLL during standby.	0x0	RW
4	STBY_JESD_PLL	1: power down JESD interface PLL during standby.	0x0	RW
3	STBY_JESD_PHY	1: power down JESD interface transmitters during standby.	0x0	RW
2	STBY_FRAMER	1: power down JESD interface framer logic during standby.	0x0	RW
1	STBY_DATAPATH	1: power down digital datapath during standby.	0x1	RW
0	STBY_DIGCLK	1: disable all digital clocks during standby.	0x0	RW

Digital Power-Down Register

Address: 0x151, Reset: 0x00, Name: PD_DIG

Table 65. Bit Descriptions for PD_DIG

Bits	Bit Name	Description	Reset	Access
[7:3]	RESERVED		0x00	RW
2	PD_FRAMER	1: power down JESD interface framer logic.	0x0	RW
1	PD_DATAPATH	1: power down digital datapath.	0x0	RW
0	PD_DIGCLK	1: power down all digital clocks.	0x0	RW

Standby Pin Control Register

Address: 0x152, Reset: 0x00, Name: PD_PIN_CTRL

Table 66. Bit Descriptions for PD_PIN_CTRL

Bits	Bit Name	Settings	Description	Reset	Access
[7:5]	RESERVED			0x0	RW
4	PD_PIN_EN	0 1	Enable Standby Mode Control from a GPIO Pin. Use only register 2 to select standby mode. Use Register 2 or the selected pin to select standby mode. Standby mode is the logical OR of the register setting and the pin state.	0x0	RW
[3:2]	RESERVED			0x0	RW
[1:0]	PD_PIN_SEL	00 01 10 11	Select GPIO pin for standby control. Use AGC1 for standby control. Use AGC2 for standby control. Use AGC3 for standby control. Use AGC4 for standby control.	0x0	RW

Attenuator Mode Register

Address: 0x180, Reset: 0x00, Name: ATTEN_MODE

Table 67. Bit Descriptions for ATTEN_MODE

Bits	Bit Name	Description	Reset	Access
[7:1]	RESERVED		0x00	RW
0	ATTEN_MODE	Attenuator Mode. 0 = Use AGC2 pin to select between values in Register 0x0181 and Register 0x0182. 1 = Use AGC1 and AGC2 pins to decrement/increment attenuation value.	0x0	RW

Attenuator AGC2 Pin Low Value Register

Address: 0x181, Reset: 0x0C, Name: ATTEN_VALUE_PIN0

Table 68. Bit Descriptions for ATTEN_VALUE_PIN1

Bits	Bit Name	Description	Reset	Access
[7:0]	ATTEN_VALUE_PIN0	Attenuation value to be used in ATTEN_MODE = 0 when the AGC2 pin is low. Valid range is from 0 (minimum attenuation) to 27 (maximum attenuation). Value 28 to Value 31 disable the attenuator. Default is 12 dB attenuation.	0x0C	RW

Attenuator AGC2 Pin High Value Register

Address: 0x182, Reset: 0x0C, Name: ATTEN_VALUE_PIN1

Table 69. Bit Descriptions for ATTEN_VALUE_PIN1

Bits	Bit Name	Description	Reset	Access
[7:0]	ATTEN_VALUE_PIN1	Attenuation value to be used in ATTEN_MODE = 0 when the AGC2 pin is high. Valid range is from 0 (minimum attenuation) to 27 (maximum attenuation). Value 28 to Value 31 disable the attenuator. Default is 12 dB attenuation.	0x0C	RW

Attenuator Initialization Register

Address: 0x183, Reset: 0x00, Name: ATTEN_INIT

Table 70. Bit Descriptions for ATTEN_INIT

Bits	Bit Name	Description	Reset	Access
[7:0]	ATTEN_INIT	Initialize the attenuator value when using ATTEN_MODE = 1.	0x00	RW

Attenuator Status Register

Address: 0x184, Reset: 0x0C, Name: ATTEN_CTL

Table 71. Bit Descriptions for ATTEN_CTL

Bits	Bit Name	Description	Reset	Access
7	ATT_PIN	Read back the state of the AGC2 pin.	0x0	R
[6:5]	RESERVED		0x0	RW
[4:0]	ATTEN_READ	Read back the actual attenuation value in ATTEN_MODE.	0x0C	R

ADC Reset Threshold Register

Address: 0x188, Reset: 0x05, Name: ADCRE_THRH

Table 72. Bit Descriptions for ADCRE_THRH

Bits	Bit Name	Description	Reset	Access
[7:3]	RESERVED		0x00	RW
[2:0]	ADCRE_THRH	ADC Reset Threshold. The ADC reset triggers if more than threshold out of eight consecutive ADC samples have the full-scale value of ± 8 .	0x5	RW

ADC Reset Pulse Length Register

Address: 0x189, Reset: 0x01, Name: ADCRE_PULSE_LEN

Table 73. Bit Descriptions for ADCRE_PULSE_LEN

Bits	Bit Name	Description	Reset	Access
[7:5]	RESERVED		0x0	RW
[4:0]	ADCRE_PULSE_LEN	The duration of the reset pulse to the ADC, $(x + 1) \times 8/F_{ADC}$.	0x01	RW

ADC Reset Attenuation Step Register

Address: 0x18A, Reset: 0x06, Name: ATTEN_STEP_RE

Table 74. Bit Descriptions for ATTEN_STEP_RE

Bits	Bit Name	Description	Reset	Access
[7:5]	RESERVED		0x0	RW
[4:0]	ATTEN_STEP_RE	The size of the increase in attenuation after a reset event, in dB. The attenuation is clipped to a maximum value of 27 dB.	0x06	RW

ADC Unstable Flag Control Register

Address: 0x18F, Reset: 0x00, Name: ADC_UNSTABLE

Table 75. Bit Descriptions for ADC_UNSTABLE

Bits	Bit Name	Description	Reset	Access
[7:2]	RESERVED		0x00	RW
1	CLEAR_UNSTABLE_FLAG	Clear unstable flag. Writing a 1 to this bit clears the UNSTABLE_FLAG. This bit is self clearing.	0x0	RW
0	UNSTABLE_FLAG	Unstable flag. This is a sticky flag that indicates if an ADC reset condition has been detected. It is cleared only by the CLEAR_UNSTABLE_FLAG bit and the hardware/software resets.	0x0	R

Peak Threshold 0 LSB Register

Address: 0x193, Reset: 0x00, Name: PKTHRHO_LSB

Table 76. Bit Descriptions for PKTHRHO_LSB

Bits	Bit Name	Settings	Description	Reset	Access
[7:0]	PKTHRHO_LSB		Peak Threshold 0 LSB.	0x00	RW

Peak Threshold 0 MSB Register

Address: 0x194, Reset: 0x00, Name: PKTHRHO_MSB

Table 77. Bit Descriptions for PKTHRHO_MSB

Bits	Bit Name	Settings	Description	Reset	Access
[7:4]	RESERVED			0x0	RW
[3:0]	PKTHRHO_MSB		Peak Threshold 0 MSB.	0x0	RW

Peak Threshold 1 LSB Register

Address: 0x195, Reset: 0x00, Name: PKTHRHI_LSB

Table 78. Bit Descriptions for PKTHRHI_LSB

Bits	Bit Name	Settings	Description	Reset	Access
[7:0]	PKTHRHI_LSB		Peak Threshold 1 LSB.	0x00	RW

Peak Threshold 1 MSB Register

Address: 0x196, Reset: 0x00, Name: PKTHRHI_MSB

Table 79. Bit Descriptions for PKTHRHI_MSB

Bits	Bit Name	Settings	Description	Reset	Access
[7:4]	RESERVED			0x0	RW
[3:0]	PKTHRHI_MSB		Peak Threshold 1 MSB.	0x0	RW

DEC Low Threshold LSB Register

Address: 0x197, Reset: 0x00, Name: LOWTHRH_LSB

Table 80. Bit Descriptions for LOWTHRH_LSB

Bits	Bit Name	Settings	Description	Reset	Access
[7:0]	LOWTHRH_LSB		Low Threshold LSB.	0x00	RW

Low Threshold MSB Register

Address: 0x198, Reset: 0x00, Name: LOWTHRH_MSB

Table 81. Bit Descriptions for LOWTHRH_MSB

Bits	Bit Name	Settings	Description	Reset	Access
[7:4]	RESERVED			0x0	RW
[3:0]	LOWTHRH_MSB		Low Threshold MSB.	0x0	RW

Dwell Time Mantissa Register

Address: 0x199, Reset: 0x00, Name: DWELL_TIME_MANTISSA

Table 82. Bit Descriptions for DWELL_TIME_MANTISSA

Bits	Bit Name	Settings	Description	Reset	Access
[7:0]	DWELL_TIME_MANTISSA		Dwell Time mantissa.	0x00	RW

Dwell Time Exponent Register

Address: 0x19A, Reset: 0x00, Name: DWELL_TIME_EXP

Table 83. Bit Descriptions for DWELL_TIME_EXP

Bits	Bit Name	Settings	Description	Reset	Access
[7:4]	RESERVED			0x0	RW
[3:0]	DWELL_TIME_EXP		Dwell Time Exponent.	0x0	RW

AGC Flag 0 Select Register

Address: 0x19B, Reset: 0x00, Name: FLAG0_SEL

Table 84. Bit Descriptions for FLAG0_SEL

Bits	Bit Name	Description	Reset	Access
[7:3]	RESERVED		0x00	RW
[2:0]	FLAG0_SEL	Select 1 of 4 flags to output on the AGC3 pin. 000 = ADC reset pulse. 100 = DEC peak above DEC Threshold 0. 101 = DEC peak above DEC Threshold 1. 110 = DEC peak below DEC low threshold for dwell time.	0x0	RW

AGC Flag 1 Select Register

Address: 0x19C, Reset: 0x00, Name: FLAG1_SEL

Table 85. Bit Descriptions for FLAG1_SEL

Bits	Bit Name	Description	Reset	Access
[7:3]	RESERVED		0x00	RW
[2:0]	FLAG1_SEL	Select one of four flags to output on the AGC4 pin. 000 = ADC reset pulse. 100 = DEC peak above DEC Threshold 0. 101 = DEC peak above DEC Threshold 1. 110 = DEC peak below DEC low threshold for dwell time.	0x0	RW

AGC Flag Enable Register

Address: 0x19E, Reset: 0x00, Name: EN_FLAG

Table 86. Bit Descriptions for EN_FLAG

Bits	Bit Name	Description	Reset	Access
[7:5]	RESERVED		0x0	RW
4	EN_OR	Combine ADC reset with peak detect. When asserted, this bit causes the ADC reset pulse (Flag Select Option 0) to be logically OR-ed with one of the peak-detect flags options specified in Register 0x19B or Register 0x19C.	0x0	RW
[3:2]	RESERVED		0x0	RW
1	EN_FLAG1	Enable Flag 1. 0 = Force AGC4 pin low. 1 = Enable selected flag on AGC4 pin (see FLAG1_SEL).	0x0	RW
0	EN_FLAG0	Enable Flag 0. 0 = Force AGC3 pin low. 1 = Enable selected flag on AGC3 pin (see FLAG0_SEL).	0x0	RW

Force GPIO Register

Address: 0x1B0, Reset: 0x00, Name: FORCE_GPIO

Table 87. Bit Descriptions for FORCE_GPIO

Bits	Bit Name	Description	Reset	Access
[7:4]	RESERVED		0x0	RW
[3:0]	FORCE_GPIO	Force GPIO use. Force one or more of the pins, AGC1 to AGC4, to be used as a GPIO rather than any other specified use. Bit 0: force AGC1 to be used as a GPIO. Bit 1: force AGC2 to be used as a GPIO. Bit 2: force AGC3 to be used as a GPIO. Bit 3: force AGC4 to be used as a GPIO.	0x00	RW

Force GPIO as Output Register

Address: 0x1B1, Reset: 0x00, Name: FORCE_GPIO_OUT

Table 88. Bit Descriptions for FORCE_GPIO_OUT

Bits	Bit Name	Description	Reset	Access
[7:4]	RESERVED		0x0	RW
[3:0]	FORCE_GPIO_OUT	Force GPIO use as an output. When used in conjunction with FORCE_GPIO, configure one or more of the pins, AGC1 to AGC4, to be used as a general purpose output or input. Bit 0 = 1: use AGC1 as an output. Bit 0 = 0: use AGC1 as an input. Bit 1 = 1: use AGC2 as an output. Bit 1 = 0: use AGC2 as an input. Bit 2 = 1: use AGC3 as an output. Bit 2 = 0: use AGC3 as an input. Bit 3 = 1: use AGC4 as an output. Bit 3 = 0: use AGC4 as an input.	0x00	RW

Force GPIO Value Register

Address: 0x1B2, Reset: 0x00, Name: FORCE_GPIO_VAL

Table 89. Bit Descriptions for FORCE_GPIO_VAL

Bits	Bit Name	Description	Reset	Access
[7:4]	RESERVED		0x0	RW
[3:0]	FORCE_GPIO_VAL	Force GPIO Value. When used in conjunction with FORCE_GPIO and FORCE_GPIO_OUT, configure the state of one or more of the pins, AGC1 to AGC4, when being used as a general purpose output.	0x00	RW
		Bit [0]: state of AGC1 when being used as an output.		
		Bit [1]: state of AGC2 when being used as an output.		
		Bit [2]: state of AGC3 when being used as an output.		
		Bit [3]: state of AGC4 when being used as an output.		

GPIO Output Status Register

Address: 0x1B3, Reset: 0x00, Name: READ_GPO

Table 90. Bit Descriptions for READ_GPO

Bits	Bit Name	Description	Reset	Access
[7:4]	RESERVED		0x0	RW
[3:0]	READ_GPO	Read back the status of the GPIO output bits. These are the same as the external pins, AGC1 through AGC4, if the GPIO are enabled and configured as outputs.	0x00	R

GPIO Input Status Register

Address: 0x1B4, Reset: 0x00, Name: READ_GPI

Table 91. Bit Descriptions for READ_GPI

Bits	Bit Name	Description	Reset	Access
[7:4]	RESERVED		0x0	RW
[3:0]	READ_GPI	Read back the status of the GPIO input bits. These are the same as the external pins, AGC1 through AGC4, if the GPIO are enabled and configured as inputs	0x00	R

JESD204 DID Register

Address: 0x1C0, Reset: 0x00, Name: DID

Table 92. Bit Descriptions for DID

Bits	Bit Name	Description	Reset	Access
[7:0]	DID	Device ID	0x00	RW

JESD204 BID Register

Address: 0x1C1, Reset: 0x00, Name: BID

Table 93. Bit Descriptions for BID

Bits	Bit Name	Description	Reset	Access
[7:4]	RESERVED		0x0	R
[3:0]	BID	Bank ID	0x0	RW

JESD204 L/SCR Register

Address: 0x1C3, Reset: 0x00, Name: L

Table 94. Bit Descriptions for L

Bits	Bit Name	Settings	Description	Reset	Access
7	SCR		SCR Parameter.	0x0	RW
		0	Scrambling disabled.		

Bits	Bit Name	Settings	Description	Reset	Access
		1	Scrambling enabled.		
[6:5]	RESERVED			0x0	RW
[4:0]	L		L Parameter.	0x00	RW
		00000	One lane.		
		00001	Two lanes.		

JESD204 F Register

Address: 0x1C4, Reset: 0x03, Name: F

Table 95. Bit Descriptions for F

Bits	Bit Name	Settings	Description	Reset	Access
[7:0]	F		Octest per Frame per Lane.	0x03	RW
		00000001	F = 2		
		00000011	F = 4		

JESD204 K Register

Address: 0x1C5, Reset: 0x1F, Name: K

Table 96. Bit Descriptions for K

Bits	Bit Name	Settings	Description	Reset	Access
[7:5]	RESERVED			0x0	RW
[4:0]	K		Frames per multiframe. Number of frames per multiframe is the register value plus one.	0x1F	RW

JESD204 M Register

Address: 0x1C6, Reset: 0x01, Name: M

Table 97. Bit Descriptions for M

Bits	Bit Name	Settings	Description	Reset	Access
[7:0]	M		M.	0x01	RW
		00000001	Two converters (I/Q data).		

JESD204 S Register

Address: 0x1C9, Reset: 0x00, Name: S

Table 98. Bit Descriptions for S

Bits	Bit Name	Settings	Description	Reset	Access
[7:5]	RESERVED			0x0	RW
[4:0]	S		S.	0x00	RW
		00000	One sample per frame (the only valid option).		

JESD204 RES1 Register

Address: 0x1CB, Reset: 0x00, Name: RES1

Table 99. Bit Descriptions for RES1

Bits	Bit Name	Description	Reset	Access
[7:0]	RES1		0x00	RW

JESD204 RES2 Register

Address: 0x1CC, Reset: 0x00, Name: RES2

Table 100. Bit Descriptions for RES2

Bits	Bit Name	Description	Reset	Access
[7:0]	RES2		0x00	RW

JESD204 LID0 Register

Address: 0x1D0, Reset: 0x00, Name: LID0

Table 101. Bit Descriptions for LID0

Bits	Bit Name	Description	Reset	Access
[7:5]	RESERVED		0x0	RW
[4:0]	LID0	Lane ID for Lane 0.	0x00	RW

JESD204 LID1 Register

Address: 0x1D1, Reset: 0x01, Name: LID1

Table 102. Bit Descriptions for LID1

Bits	Bit Name	Description	Reset	Access
[7:5]	RESERVED		0x0	RW
[4:0]	LID1	Lane ID for Lane 1.	0x01	RW

JESD204 FCHK0 Register

Address: 0x1D8, Reset: 0x44, Name: FCHK0

Table 103. Bit Descriptions for FCHK0

Bits	Bit Name	Description	Reset	Access
[7:0]	FCHK0	Checksum for Lane 0.	0x44	RW

JESD204 FCHK1 Register

Address: 0x1D9, Reset: 0x45, Name: FCHK1

Table 104. Bit Descriptions for FCHK1

Bits	Bit Name	Description	Reset	Access
[7:0]	FCHK1	Checksum for Lane 1.	0x45	RW

Enable Lane FIFO Register

Address: 0x1E0, Reset: 0x00, Name: EN_LFIFO

Table 105. Bit Descriptions for EN_LFIFO

Bits	Bit Name	Description	Reset	Access
[7:1]	RESERVED		0x00	RW
0	EN_LFIFO	Lane FIFO Enable. Once the entire configuration of the framer has been completed, and the link is powered up, set this bit to start the lane FIFOs that manage the hand-off of data from the framer to the transmitter PHY.	0x0	RW

Swap Register

Address: 0x1E1, Reset: 0x00, Name: SWAP

Table 106. Bit Descriptions for SWAP

Bits	Bit Name	Settings	Description	Reset	Access
[7:6]	RESERVED			0x0	RW
[5:4]	SWAP_CONV	00 01 10 11	Bit [4] swaps the source of Framer Converter 0 (default is I channel). Bit [5] swaps the source of Framer Converter 1 (default is Q channel). 00 Framer Input 1 = Q channel; Framer Input 0 = I channel 01 Framer Input 1 = Q channel; Framer Input 0 = Q channel 10 Framer Input 1 = I channel; Framer Input 0 = I channel 11 Framer Input 1 = I channel; Framer Input 0 = Q channel	0x0	RW
[3:2]	RESERVED			0x0	RW
[1:0]	SWAP_LANE	00 01 10 11	Bit [0] swaps the source of physical output lane 0. Bit [1] swaps the source of physical output lane 1. 00 Output Lane 1 = Framer lane 1; Output Lane 0 = Framer Lane 0 01 Output Lane 1 = Framer lane 1; Output Lane 0 = Framer Lane 1 10 Output Lane 1 = Framer lane 0; Output Lane 0 = Framer Lane 0 11 Output Lane 1 = Framer lane 0; Output Lane 0 = Framer Lane 1	0x0	RW

Link/Lane Power-Down Register

Address: 0x1E2, Reset: 0x00, Name: LANE_PD

Table 107. Bit Descriptions for LANE_PD

Bits	Bit Name	Description	Reset	Access
[7:4]	ILAS_DELAY	ILAS Start Delay. Usually the ILAS starts on the first LMFC rising edge after SYNCINB goes high. This value delays the ILAS by the given number of LMFC periods (multiframe periods).	0x0	RW
[3:2]	RESERVED		0x0	RW
[1:0]	LANE_PD	Lane Power-down. Bit 0 powers down transmitter PHY for Lane 0. Bit 1 powers down transmitter PHY for Lane 1.	0x0	RW

Interface Control 0 Register

Address: 0x1E3, Reset: 0x14, Name: MIS1

Table 108. Bit Descriptions for MIS1

Bits	Bit Name	Description	Reset	Access
[7:6]	RESERVED		0x0	RW
5	TEST_SAMPLE_EN	0 = Disable transport layer test samples. 1 = Enable transport layer test samples.	0x0	RW
4	LSYNC_EN	0 = Disable lane synchronization. 1 = Enable lane synchronization (default).	0x1	RW
[3:2]	ILAS_MODE	01 = Enable ILAS (default). 11 = ILAS always on; data link layer test mode.	0x1	RW
1	FACI_DISABLE	Control of Frame Alignment Characters. 0 = Enable frame alignment character insertion. 1 = Disable frame alignment character insertion.	0x0	RW
0	RESERVED		0x0	RW

Interface Control 1 Register

Address: 0x1E4, Reset: 0x00, Name: SYNC_PIN

Table 109. Bit Descriptions for SYNC_PIN

Bits	Bit Name	Description	Reset	Access
[7:6]	RESERVED		0x0	RW
5	SYNC_PIN_INV	0 = do not invert SYNCINB pin; SYNCINB is active low. 1 = invert SYNCINB pin; SYNCINB is active high.	0x0	RW
[4:2]	RESERVED		0x0	RW
1	INV_10B	0 = do not invert octets. 1 = invert all bits in 10-bit octets from framer. Setting the bit to 1 has the same effect as swapping the differential output data pins.	0x0	RW
0	RESERVED		0x0	RW

Interface Test Register

Address: 0x1E5, Reset: 0x00, Name: TEST_GEN

Table 110. Bit Descriptions for TEST_GEN

Bits	Bit Name	Settings	Description	Reset	Access
[7:6]	RESERVED			0x0	RW
[5:4]	TEST_GEN_SEL		Test Point.	0x0	RW
		00	Insert test data at framer input (16 bits).		
		01	Insert test data at PHY input (10 bits).		
		10	Insert test data at scrambler input (8 bits).		
[3:0]	TEST_GEN_MODE		Test Mode.	0x0	RW
		0000	Normal mode; test disabled.		
		0001	Alternating checkerboard.		
		0010	1/0 word toggle.		
		0011	Long PN sequence.		
		0100	Short PN sequence.		
		0101	Repeating user pattern mode.		
		0110	Single user pattern mode.		
		0111	Ramp. Note that in single lane mode the Q sample is 1 LSB less than the I sample. In other words, $Q[n] = I[n] - 1$ LSB, where n is n th IQ sample.		
		1000	Modified RPAT sequence.		
		1001	Not used.		
		1010	JSPAT sequence.		
		1011	JTSPAT sequence.		

ILAS Count Register

Address: 0x1E6, Reset: 0x00, Name: KF_ILAS

Table 111. Bit Descriptions for KF_ILAS

Bits	Bit Name	Description	Reset	Access
[7:0]	KF_ILAS	Initial Lane Assignment Sequence Count. The ILAS is transmitted (KF_ILAS + 1) times.	0x00	RW

SYNCINB and SYSREF Control Register

Address: 0x1E7, Reset: 0x00, Name: SYNCINB_CTRL

Table 112. Bit Descriptions for SYNCINB_CTRL

Bits	Bit Name	Description	Reset	Access
[7:4]	RESERVED		0x0	RW
3	PD_SYSREF_RX	Power down SYSREF receiver.	0x0	RW
2	LVDS_SYNCINB	Use LVDS for SYNCINB. (0 = CMOS, 1 = LVDS differential with 100 Ω termination).	0x0	RW
[1:0]	RESERVED		0x0	RW

Clock Synchronization Register

Address: 0x1E8, Reset: 0x00, Name: MIX_CTRL

Table 113. Bit Descriptions for MIX_CTRL

Bits	Bit Name	Description	Reset	Access
7	RESERVED		0x0	RW
6	MIX_USE_2ND	When used in conjunction with Bit 5, setting this bit causes the second SYSREF that is used to align the clocks to also be used to reset the mixer NCO phases. This bit does not self-clear. This bit is only active when Bit 2 is also active.	0x0	RW
5	MIX_NEXT	Once set, only the next SYSREF pulse that is used to align the clock dividers is also used to reset the mixers NCO phases. This bit self clears after use. This bit is only active when Bit 1 is also active.	0x0	RWAC
4	MIX_ALL	Any SYSREF that is used to align the clocks is also used to reset the mixers' NCO phases. This bit is only active when Bit 0 is also active.	0x0	RW
3	RESERVED		0x0	RW
2	USE_2ND_SYSREF	When used in conjunction with Bit 1, setting this bit causes the second SYSREF to be used for alignment rather than the first. This bit does not self clear.	0x0	RW
1	NEXT_SYSREF	Once set, only the next SYSREF pulse is used to align the clock dividers. This bit self-clears after the next SYSREF.	0x0	RWAC
0	ALL_SYSREF	All SYSREF pulses are used to align the clock dividers.	0x0	RW

LMFC Offset Register

Address: 0x1E9, Reset: 0x00, Name: K_OFFSET

Table 114. Bit Descriptions for K_OFFSET

Bits	Bit Name	Description	Reset	Access
[7:5]	RESERVED		0x0	RW
[4:0]	K_OFFSET	This register provides an offset that moves the position of the internal LMFC with respect to SYSREF. A larger value places the LMFC later in time. In units of frame periods.	0x00	RW

SYSREF Window Register

Address: 0x1EA, Reset: 0x00, Name: SYSREF

Table 115. Bit Descriptions for SYSREF

Bits	Bit Name	Description	Reset	Access
[7:4]	SYSREF_WIN_NEG	SYSREF_WIN_NEG. Do not align clocks if SYSREF is no earlier than register value before its expected position. In units of $2/F_{ADC}$.	0x0	RW
[3:0]	SYSREF_WIN_POS	SYSREF_WIN_POS. Do not align clocks if SYSREF is no later than register value after its expected position. In units of $2/F_{ADC}$.	0x0	RW

PHY Control 0 Register

Address: 0x1EB, Reset: 0x1C, Name: SER1

Table 116. Bit Descriptions for SER1

Bits	Bit Name	Description	Reset	Access
7	SER_DRV_PS	Serializer Polarity Selection.	0x0	RW
		0 = Polarity not inverted.		
		1 = Polarity inverted.		
[6:0]	RESERVED		0x1C	RW

PHY Control 1 Register

Address: 0x1EC, Reset: 0x00, Name: SER2

Table 117. Bit Descriptions for SER1

Bits	Bit Name	Description	Reset	Access
[7:4]	SER_ITRIM	Driver bias current trim with recommended setting of 0x0B.	0x9	RW
[3:0]	SER_RTRIM	Resistor termination code with recommended setting of 0x0D.	0xB	RW

PHY Control 3 Register

Address: 0x1EF, Reset: 0x00, Name: PRE-EMPHASIS

Table 118. Bit Descriptions for PRE-EMPHASIS

Bits	Bit Name	Description	Reset	Access
7	SER_EMP_PS1	Toggle Polarity of Lane 1 Emphasis.	0x0	RW
[6:4]	SER_EMP_IDAC1	Lane 1 IDAC Setting.	0x0	RW
		00: 0 mV emphasis differential p-p.		
		01: 160 mV emphasis differential p-p.		
		10: 80 mV emphasis differential p-p.		
		11: 40 mV emphasis differential p-p.		
3	SER_EMP_PS0	Toggle polarity of Lane 0 emphasis.	0x0	RW
[2:0]	SER_EMP_IDAC0	Lane 0 IDAC Setting.	0x0	RW
		00: 0 mV emphasis differential p-p.		
		01: 160 mV emphasis differential p-p.		
		10: 80 mV emphasis differential p-p.		
		11: 40 mV emphasis differential p-p.		

ADC Standby 0 Register

Address: 0x250, Reset: 0xFF, Name: STBY_DAC

Table 119. Bit Descriptions for STBY_DAC

Bits	Bit Name	Description	Reset	Access
[7:0]	STBY_DAC	Setting register to 0x95 results in faster standby ADC recovery time.	0xFF	RW

CLKSYN Enable Register

Address: 0x2A0, Reset: 0x00, Name: CLKSYN_ENABLE

Table 120. Bit Descriptions for CLKSYN_ENABLE

Bits	Bit Name	Description	Reset	Access
7	EN_EXTCK	EXTCK Enable.	0x0	RW
6	EN_ADC_CK	ADC CK Enable.	0x0	RW
5	EN_SYNTH	Synthesizer Enable.	0x0	RW
4	EN_VCO_PTAT	VCO PTAT Enable.	0x0	RW
3	EN_VCO_ALC	VCO ALC Enable.	0x0	RW
2	EN_VCO	VCO Enable.	0x0	RW
1	EN_OVERRIDE_CAL	Override Calibration Enable.	0x0	RW
0	EN_OVERRIDE	Override Enable.	0x0	RW

CLKSYN Integer N LSB Register

Address: 0x2A1, Reset: 0x80, Name: CLKSYN_INT_N_LSB

Table 121. Bit Descriptions for CLKSYN_INT_N_LSB

Bits	Bit Name	Description	Reset	Access
[7:0]	INT_N_LSB	Lower LSBs of 11-bit Integer-N Value.	0x80	RW

CLKSYN Integer N MSB Register

Address: 0x2A2, Reset: 0x00, Name: CLKSYN_INT_N_MSB

Table 122. Bit Descriptions for CLKSYN_INT_N_MSB

Bits	Bit Name	Description	Reset	Access
[7:3]	RESERVED		0x0	RW
[2:0]	INT_N_MSB	Upper 3 MSBs of 11-bit Integer N Value.	0x0	RW

CLKSYN VCO Calibration RESET Register

Address: 0x2A5, Reset: 0x00, Name: VCO_CAL_RESET

Table 123. Bit Descriptions for VCO_CAL_RESET

Bits	Bit Name	Description	Reset	Access
[7:4]	RESERVED		0x0	RW
3	VCO_CAL_RESET	Reset VCO Calibration.	0	RW
[2:0]	RESERVED		0x0	RW

CLKSYN KVCO VCO Register

Address: 0x2A9, Reset: 0x00, Name: CLKSYN_KVCO

Table 124. Bit Descriptions for CLKSYN_KVCO

Bits	Bit Name	Description	Reset	Access
[7:4]	VCO KVCO VAR		0x0	RW
[3:0]	VCO_ALC_LVL		0xA	RW

CLKSYN VCO Bias Register

Address: 0x2AA, Reset: 0x37, Name: CLKSYN_VCO_BIAS

Table 125. Bit Descriptions for CLKSYN_VCO_BIAS

Bits	Bit Name	Description	Reset	Access
[7:6]	RESERVED		0	RW
[5:4]	BIAS_TEMP_CO	VCO Bias Tempco Setting.	0x3	RW
3	RESERVED		0	RW
[2:0]	BIAS	VCO Bias Setting.	0x7	RW

CLKSYN VCO Calibration Register

Address: 0x2AB, Reset: 0xC0, Name: CLKSYN_VCO_CAL

Table 126. Bit Descriptions for CLKSYN_VCO_CAL

Bits	Bit Name	Description	Reset	Access
[7:4]	INIT_ALC_VALUE	Initial Automatic Level Control Value.	0xC	RW
3	ALC_DIS	ALC calibration Test Bit.	0	RW
[2:1]	RESERVED		0	RW
0	ID_SYNTH	Initiates VCO Calibration.	0	RW

CLKSYN Charge Pump Register

Address: 0x2AC, Reset: 0x19, Name: CLKSYN_I_CP

Table 127. Bit Descriptions for CLKSYN_I_CP

Bits	Bit Name	Description	Reset	Access
[7:6]	RESERVED		0x0	RW
[5:0]	I_CP	Charge Pump Current = $\min(63, 1.33 \times 10^{28} / (f_{\text{PFD}} \times F_{\text{CLK}}^2) - 1)$.	0x19	RW

CLKSYN Charge Pump Calibration Register

Address: 0x2AD, Reset: 0x00, Name: EN_CP_CAL

Table 128. Bit Descriptions for EN_CP_CAL

Bits	Bit Name	Description	Reset	Access
[7:6]	EN_CP_CAL		0x0	RW
[6:0]	RESERVED		0x0	RW

CLKSYN VCO Varactor Register

Address: 0x2B7, Reset: 0xD0, Name: CLKSYN_VCO_VAR

Table 129. Bit Descriptions for CLKSYN_VCO_VAR

Bits	Bit Name	Description	Reset	Access
[7:4]	VCO_VAR	VCO Varactor Setting.	0xD0	RW
[3:0]	RESERVED			

CLKSYN Reference Divider and SYSREF Control Register

Address: 0x2BB, Reset: 0xB9, Name: CLKSYN_R_DIV

Table 130. Bit Descriptions for CLKSYN_R_DIV

Bits	Bit Name	Description	Reset	Access
[7:6]	R_DIV	00 = div-by-1; 01 = div-by-2; 10 = div-by-4; 11 = multiply-by-2.	10	RW
[5:4]	RESERVED		0x3	RW
3	SYSREF_CTRL	SYSREF Input Sampling Clock. 0 = use clock synthesizer reference clock. 1 = use internal clock at $F_{ADC}/2$ (use for nonclock synthesizer case).	1	RW
2	CLKIN_IMPED	CLKIN Impedance. 0 = configure CLK± as 100 Ω termination, configuration for clock synthesizer disabled. 1 = configure CLK+ as high-Z, configuration for clock synthesizer enabled.	0	RW
[1:0]	RESERVED		0x1	RW

CLKSYN Status Register

Address: 0x2BC, Reset: 0x80, Name: CLKSYN_STATUS

Table 131. Bit Descriptions for CLKSYN_STATUS

Bits	Bit Name	Description	Reset	Access
[7:4]	RESERVED		0x8	R
3	PLL_LCK	Clock Synthesizer Lock Bit (1 = lock).	0x0	R
2	RESERVED		0x0	R
1	VCO CAL BUSY	VCO Calibration Busy (0 = done).	0x0	R
0	CP CAL DONE	Charge Pump Calibration Done (1 = done).	0x0	R

JESDSYN Status Register

Address: 0x2DC, Reset: 0x80, Name: JESDSYN_STATUS

Table 132. Bit Descriptions for JESDSYN_STATUS

Bits	Bit Name	Description	Reset	Access
[7:4]	RESERVED		0x8	R
3	PLL_LCK	JESD204 PLL Synthesizer Lock Bit (1 = lock).	0x0	R
2	RESERVED		0x0	R
1	VCO CAL BUSY	VCO Calibration Busy (0 = done).	0x0	R
0	CP CAL DONE	Charge Pump Calibration Done (1 = done).	0x0	R

Shuffler Control Register

Address: 0x340, Reset: 0x03, Name: SHUFFLE_CTRL

Table 133. Bit Descriptions for SHUFFLE_CTRL

Bits	Bit Name	Description	Reset	Access
[7:2]	RESERVED		0x00	RW
1	RESERVED		1	RW
0	EN_ADAPTIVE_SHUFFLE	Enable Adaptive Flash Shuffling.	1	RW

Shuffler Threshold 1 and 2 Register

Address: 0x342, Reset: 0xF5, Name: SHUFFLE_THREG_0

Table 134. Bit Descriptions for SHUFFLE_THREG_0

Bits	Bit Name	Description	Reset	Access
[7:4]	SHUFFLE_TH2	Threshold value for shuffling every two cycles. Shuffle-every-2 is triggered when the ADC data is greater than or equal to this threshold.	0xF	R
[3:0]	SHUFFLE_TH1	Threshold value for shuffling every one cycle. Shuffle-every-1 is triggered when the ADC data is greater than or equal to this threshold	0x5	R

Shuffler Threshold 3 and 4 Register

Address: 0x343, Reset: 0xFF, Name: SHUFFLE_THREG_1

Table 135. Bit Descriptions for SHUFFLE_THREG_1

Bits	Bit Name	Description	Reset	Access
[7:4]	SHUFFLE_TH4	Threshold value for shuffling every four cycles. Shuffle-every-4 is triggered when the ADC data is greater than or equal to this threshold.	0xF	R
[3:0]	SHUFFLE_TH3	Threshold value for shuffling every three cycles. Shuffle-every-3 is triggered when the ADC data is greater than or equal to this threshold	0xF	R