



Features

- Miniature Thermal Cutoff (TCO) device
- Small body size
- Overtemperature and overcurrent protection
- Controls abnormal, excessive current virtually instantaneously, up to rated limits
- Wide range of temperature options
- High corrosion resistance
- AEC-Q200 compliant***

AD Series Breaker (Thermal Cutoff Device)

Ratings

Specification	ADxxABB	ADxxWBB
Trip Temperature ¹	+55 to +150 °C ± 5 °C	
Reset Temperature ¹	20 °C or 40 °C min.	20 °C or 40 °C min.
Contact Rating	DC14 V / 8 A, 10,000 cycles	
Breaking Current	DC14 V / 35 A, 100 cycles	DC14 V / 8 A, 10,000 cycles
Max. Voltage	DC28 V / 8 A, 100 cycles	DC14 V / 8 A, 10,000 cycles
Min. Holding Voltage	8 V @ 25 °C for 1 minute	N/A
Max. Leak Current	300 mA max. @ 25 °C	N/A
Resistance	4 milliohms max.	

The setting of the trip temperature and the reset temperature can be adjusted upon request.
Note 1: See Temperature Options Chart

Product Structure

A-type

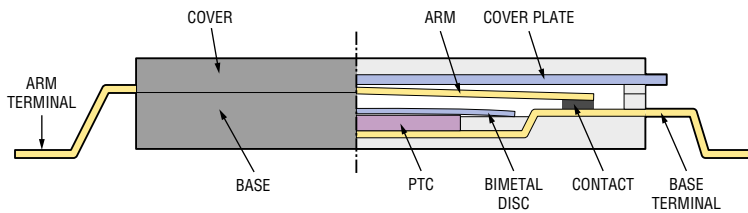

W-type

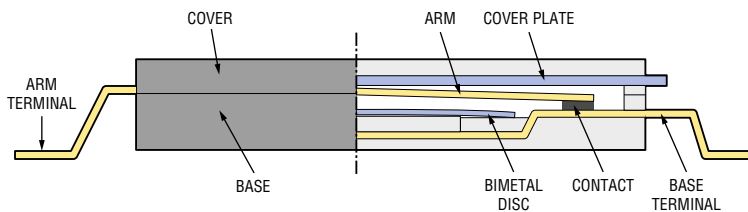

Additional Information

Click these links for more information:



How to Order

Series Designator AD 90 A B B
 Trip Temperature (±5 °C) _____
 (See Temperature Options Chart)
 Function _____
 A = Self-hold
 W = No Self-hold
 Reset Temperature _____
 B = 20 °C or 40 °C min.
 (See Temperature Options Chart)
 Special Specification Code _____
 Resin Type, Mfg. Internal Code,
 Design Mark, etc.

Circuit Diagram

A-type

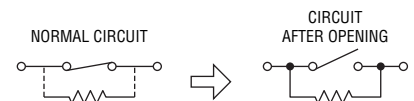

W-type



BOURNS®

Asia-Pacific: Tel: +886-2 2562-4117 • Email: asiacus@bourns.com

EMEA: Tel: +36 88 885 877 • Email: eurocus@bourns.com

The Americas: Tel: +1-951 781-5500 • Email: americus@bourns.com

www.bourns.com



**WARNING Cancer
and Reproductive Harm**
www.P65Warnings.ca.gov

*RoHS Directive 2015/863, Mar 31, 2015 and Annex.

**Bourns considers a product to be "halogen free" if (a) the Bromine (Br) content is 900 ppm or less; (b) the Chlorine (Cl) content is 900 ppm or less; and (c) the total Bromine (Br) and Chlorine (Cl) content is 1500 ppm or less.

***Meets Bourns internal AEC-Q200 equivalent test plan.

Specifications are subject to change without notice.

Users should verify actual device performance in their specific applications.

The products described herein and this document are subject to specific legal disclaimers as set forth on the last page of this document, and at www.bourns.com/docs/legal/disclaimer.pdf.

AD Series Breaker (Thermal Cutoff Device)



Product Dimensions

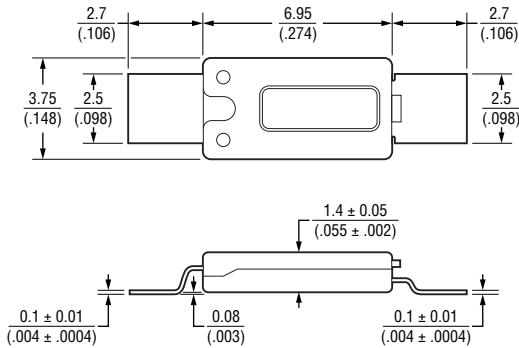

DIMENSIONS: $\frac{\text{MM}}{\text{(INCHES)}}$

GENERAL TOLERANCE: $\frac{\pm 0.1}{(\pm .004)}$

Application Temperature Range

-40 to 125 °C

Temperature Options Chart

Bourns Part Number	Trip Temperature (°C)	Reset Temperature Min. (°C)
AD55xBB	55	20
AD60xBB	60	
AD65xBB	65	
AD70xBB	70	
AD72xBB	72	
AD75xBB	75	
AD77xBB	77	
AD82xBB	82	40
AD85xBB	85	
AD90xBB	90	
AD95xBB	95	
ADA0xBB	100	
ADA5xBB	105	
ADB0xBB	110	
ADB5xBB	115	
ADC0xBB	120	
ADC5xBB	125	
ADD0xBB	130	
ADD5xBB	135	
ADE0xBB	140	
ADE5xBB	145	
ADF0xBB	150	

Typical Performance

Current vs. Temperature Curve

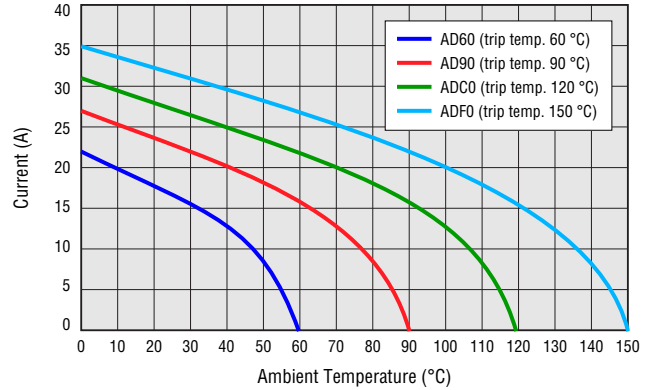

The above curves were derived from placing non-PCB mounted test samples in an oven at 25 °C, 40 °C, 60 °C, and 70 °C, increasing current flow through the sample at a rate of 0.1 A/minute and recording the current value when the sample trips. The current carrying performance is influenced by the PCB design due to copper resistance; users should verify actual device performance in their specific applications.

Typical Part Marking

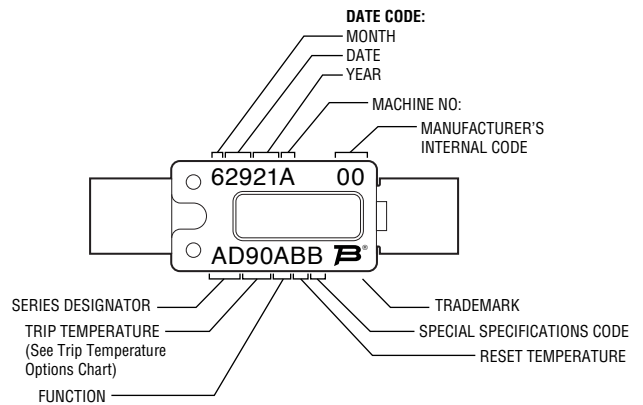

Wiring Recommendations

This is not a surface mount device for reflow soldering. Therefore, wiring should be accomplished by either resistance or laser welding or soldering.

Standard Packaging Specifications

Plastic Bag	1,000 pcs. (fixed)
Inner Box	3,000 pcs. (fixed)
Outer Box	30,000 pcs. max. (up to 10 inner boxes)

Specifications are subject to change without notice.

Users should verify actual device performance in their specific applications.

The products described herein and this document are subject to specific legal disclaimers as set forth on the last page of this document, and at www.bourns.com/docs/legal/disclaimer.pdf.

AD Series Breaker (Thermal Cutoff Device)

Storage Conditions

- 1) The breaker must be stored in the standard packaging with the following conditions: ambient temperature of -10 to +40 °C, RH <75 % with no radical temperature change, direct sunshine, excessive vibration or shock.
- 2) Avoid storage locations where there is a possibility of generating corrosive gas such as from salt breeze, chlorine, hydrogen sulfide, ammonium, sulfide-oxidation, hydrogen chloride, acetate, etc.
- 3) Storage period should be no longer than 24 months from date of shipment.

Caution when Using Breaker

Before using the breaker, please fully read the *DESIGN AND HANDLING CAUTIONS* stated below to avoid breaker performance deterioration and/or damage to the breaker body or terminal.

DESIGN AND HANDLING CAUTIONS

1. Use within the electrical ratings specified in this data sheet. If used over the rating of voltage or current, ON-OFF life might be impacted and contact may deteriorate due to breaker arm damage.
2. If used over the maximum electrical rating specified in this data sheet, the circuit may not open safely or operate properly. Please test your device for any abnormalities and confirm that the breaker will open the circuit safely in your device. Any use over the maximum electrical rating is at the sole risk of the user.
3. Mount the breaker on your device where heat is the highest in order to transfer it effectively to the breaker.
4. If the breaker is affixed with an adhesive (resin, etc.), before proceeding, fully test, evaluate and verify that the adhesive presents no negative effects on the breaker before proceeding.
5. After the breaker is mounted, affix it so that the breaker body and terminals will not move. If not affixed properly, breaker resistance could increase or contact could open due to stress during handling or vibration/shock during transportation.
6. Mount the breaker body and terminals in a straight and flat direction. If the body and terminals are mounted in a twisted condition, breaker resistance could increase or create body damage.
7. If breaker is to be resin-molded, test and evaluate the application to determine whether the breaker can be used effectively.
8. The breaker cannot be used as a repetitive ON-OFF thermostat.
9. The breaker is not washable. Do not wash.
10. Do not let a solder iron touch the breaker body.
11. Do not attach solder to the breaker body.
12. When mounting and after mounting the breaker, do not apply supersonic vibration. Vibration and heat may cause breaker resistance to increase or may cause body damage. If you plan to apply supersonic vibration after mounting the breaker, you will need to evaluate whether the breaker is suitable for your specific application. The breaker is not designed or warranted to withstand supersonic vibration.
13. Do not use the breaker in the following environments:
 - a) Water, oil, chemical or organic solutions
 - b) Direct sunlight, outdoor exposure, dust
 - c) Dew condensation, where the breaker could get wet
 - d) Salt breeze, chlorine, hydrogen sulfide, ammonium, sulfide-oxidation, hydrogen chloride, acetate and anywhere there is a possibility of generating corrosive gas such as sulfurous acid gas
 - e) Strong static electric charge or electromagnetic wave
14. The breaker is not designed or tested for, and should not be used in, aerospace, airplane, nuclear, military, life-saving, life-critical or life-sustaining medical and other related applications where failure or malfunction may result in personal injury, death or severe property or environmental damage.
15. As part of our commitment to making devices of the highest quality, Bourns tests the trip temperature of every device before shipping. Higher trip temperature models will have a darker appearance of the copper-based terminals than lower trip models as a result of this process.

Specifications are subject to change without notice.

Users should verify actual device performance in their specific applications.

The products described herein and this document are subject to specific legal disclaimers as set forth on the last page of this document, and at www.bourns.com/docs/legal/disclaimer.pdf.

Caution when using Breaker (Continued)

HANDLING CAUTIONS

1. Since the breaker body is composed of plastic parts, do not clamp or dent with tools as this could cause a resistance increase or body damage.
2. Breaker terminals are thin copper alloy with right angle edges. Handle carefully to avoid injury to fingers. Handling while wearing finger cots and using tweezers is recommended.
3. When mounting the breaker on a cell or PCM board, be careful to avoid placing excessive stress on the breaker body and terminals. Excessive stress may cause a resistance increase or body damage. Please refer to the following cautions:
 - a) Do not apply more than 10 N moment to the breaker body (refer to Figure 1).
 - b) Do not apply more than 1.5 cN-m twist torque to the breaker body (refer to Figure 2).
 - c) Do not apply more than 20 N bending force to the breaker body (refer to Figure 3).
 - d) Do not apply more than 0.5 cN-m twist torque to the breaker terminals (refer to Figure 4).
 - e) Do not apply more than 2 N force to the breaker terminals (refer to Figure 5).
 - f) Do not bend terminals more than 45 ° at root (refer to Figure 6).
 - g) Do not twist terminals more than 20 ° with the breaker body affixed.

Figure 1

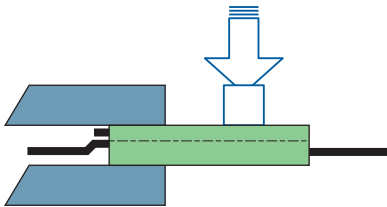

Figure 2

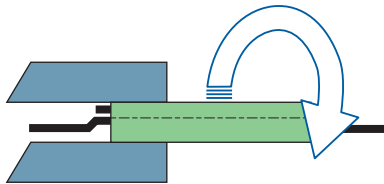

Figure 3

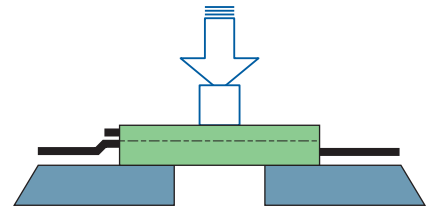

Figure 4



Figure 5

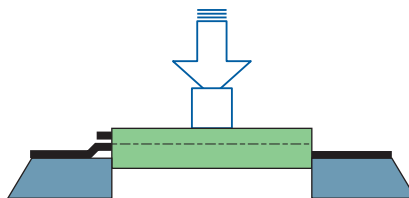

Figure 6



Due to possible updates to safety standards and other reasons, there may be changes in specifications for this data sheet without prior notification. Therefore, before design-in for your application, please contact us for the most up-to-date specifications.