

### FEATURES

#### Ultrahigh Speed

5,500 V/ $\mu$ s Slew Rate, 4 V Step, G = +2

545 ps Rise Time, 2 V Step, G = +2

#### Large Signal Bandwidth

440 MHz, G = +2

320 MHz, G = +10

#### Small Signal Bandwidth (-3 dB)

1 GHz, G = +1

700 MHz, G = +2

Settling Time 10 ns to 0.1%, 2 V Step, G = +2

#### Low Distortion over Wide Bandwidth

##### SFDR

-66 dBc @ 20 MHz, Second Harmonic

-75 dBc @ 20 MHz, Third Harmonic

##### Third Order Intercept (3IP)

26 dBm @ 70 MHz, G = +10

#### Good Video Specifications

Gain Flatness 0.1 dB to 75 MHz

0.01% Differential Gain Error,  $R_L = 150 \Omega$

0.01° Differential Phase Error,  $R_L = 150 \Omega$

#### High Output Drive

175 mA Output Load Drive

10 dBm with -38 dBc SFDR @ 70 MHz, G = +10

#### Supply Operation

+5 V to  $\pm 5$  V Voltage Supply

14 mA (Typ) Supply Current

### APPLICATIONS

Pulse Amplifier

IF/RF Gain Stage/Amplifiers

High Resolution Video Graphics

High Speed Instrumentations

CCD Imaging Amplifier



Figure 1. Large Signal Frequency Response; G = +2 and +10

### REV. F

Information furnished by Analog Devices is believed to be accurate and reliable. However, no responsibility is assumed by Analog Devices for its use, nor for any infringements of patents or other rights of third parties that may result from its use. No license is granted by implication or otherwise under any patent or patent rights of Analog Devices. Trademarks and registered trademarks are the property of their respective owners.

### FUNCTIONAL BLOCK DIAGRAMS

#### 8-Lead Plastic SOIC (R-8)



#### 5-Lead SOT-23 (RT-5)

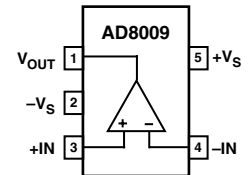

NC = NO CONNECT

### PRODUCT DESCRIPTION

The AD8009 is an ultrahigh speed current feedback amplifier with a phenomenal 5,500 V/ $\mu$ s slew rate that results in a rise time of 545 ps, making it ideal as a pulse amplifier.

The high slew rate reduces the effect of slew rate limiting and results in the large signal bandwidth of 440 MHz required for high resolution video graphic systems. Signal quality is maintained over a wide bandwidth with worst-case distortion of -40 dBc @ 250 MHz (G = +10, 1 V p-p). For applications with multitone signals, such as IF signal chains, the third order intercept (3IP) of 12 dBm is achieved at the same frequency. This distortion performance coupled with the current feedback architecture make the AD8009 a flexible component for a gain stage amplifier in IF/RF signal chains.

The AD8009 is capable of delivering over 175 mA of load current and will drive four back terminated video loads while maintaining low differential gain and phase error of 0.02% and 0.04°, respectively. The high drive capability is also reflected in the ability to deliver 10 dBm of output power @ 70 MHz with -38 dBc SFDR.

The AD8009 is available in a small SOIC package and will operate over the industrial temperature range -40°C to +85°C. The AD8009 is also available in an SOT-23-5 and will operate over the commercial temperature range of 0°C to 70°C.

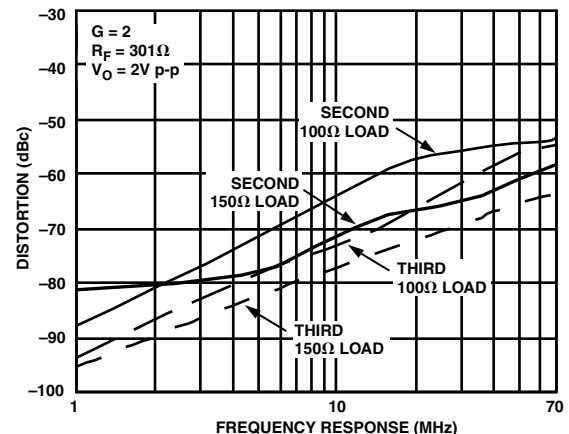

Figure 2. Distortion vs. Frequency; G = +2

# AD8009—SPECIFICATIONS

(@  $T_A = 25^\circ\text{C}$ ,  $V_S = \pm 5\text{ V}$ ,  $R_L = 100\ \Omega$ ; for R Package:  $R_F = 301\ \Omega$  for  $G = +1, +2$ ,  $R_F = 200\ \Omega$  for  $G = +10$ ; for RT Package:  $R_F = 332\ \Omega$  for  $G = +1$ ,  $R_F = 226\ \Omega$  for  $G = +2$  and  $R_F = 191\ \Omega$  for  $G = +10$ , unless otherwise noted.)

Model	Conditions	AD8009AR/JRT			Unit	
		Min	Typ	Max		
<b>DYNAMIC PERFORMANCE</b>						
-3 dB Small Signal Bandwidth, $V_O = 0.2\text{ V p-p}$	R Package	$G = +1, R_F = 301\ \Omega$		1,000	MHz	
	RT Package	$G = +1, R_F = 332\ \Omega$		845	MHz	
Large Signal Bandwidth, $V_O = 2\text{ V p-p}$	$G = +2$		480	700	MHz	
	$G = +10$		300	350	MHz	
Gain Flatness 0.1 dB, $V_O = 0.2\text{ V p-p}$	$G = +2$		390	440	MHz	
	$G = +10$		235	320	MHz	
Slew Rate	$G = +2, R_L = 150\ \Omega$		45	75	MHz	
Settling Time to 0.1%	$G = +2, R_L = 150\ \Omega, 4\text{ V Step}$		4,500	5,500	V/ $\mu\text{s}$	
	$G = +2, R_L = 150\ \Omega, 2\text{ V Step}$			10	ns	
Rise and Fall Time	$G = +10, 2\text{ V Step}$			25	ns	
	$G = +2, R_L = 150\ \Omega, 4\text{ V Step}$			0.725	ns	
<b>HARMONIC/NOISE PERFORMANCE</b>						
Second Harmonic $G = +2, V_O = 2\text{ V p-p}$	10 MHz			-73	dBc	
	20 MHz			-66	dBc	
	70 MHz			-56	dBc	
Third Harmonic	10 MHz			-77	dBc	
	20 MHz			-75	dBc	
	70 MHz			-58	dBc	
Third Order Intercept (3IP) W.R.T. Output, $G = +10$	70 MHz			26	dBm	
	150 MHz			18	dBm	
	250 MHz			12	dBm	
Input Voltage Noise	$f = 10\text{ MHz}$			1.9	nV/ $\sqrt{\text{Hz}}$	
Input Current Noise	$f = 10\text{ MHz}, +\text{In}$			46	pA/ $\sqrt{\text{Hz}}$	
	$-\text{In}$			41	pA/ $\sqrt{\text{Hz}}$	
Differential Gain Error	NTSC, $G = +2, R_L = 150\ \Omega$			0.01	0.03	%
	$R_L = 37.5\ \Omega$			0.02	0.05	%
Differential Phase Error	NTSC, $G = +2, R_L = 150\ \Omega$			0.01	0.03	Degrees
	$R_L = 37.5\ \Omega$			0.04	0.08	Degrees
<b>DC PERFORMANCE</b>						
Input Offset Voltage	$T_{\text{MIN}}$ to $T_{\text{MAX}}$			2	5	mV
					7	mV
Offset Voltage Drift				4	$\mu\text{V}/^\circ\text{C}$	
-Input Bias Current	$T_{\text{MIN}}$ to $T_{\text{MAX}}$			50	150	$\pm\mu\text{A}$
				75		$\pm\mu\text{A}$
+Input Bias Current	$T_{\text{MIN}}$ to $T_{\text{MAX}}$			50	150	$\pm\mu\text{A}$
				75		$\pm\mu\text{A}$
Open-Loop Transresistance	$T_{\text{MIN}}$ to $T_{\text{MAX}}$		90	250	k $\Omega$	
				170		k $\Omega$
<b>INPUT CHARACTERISTICS</b>						
Input Resistance	+Input			110	k $\Omega$	
	-Input			8	$\Omega$	
Input Capacitance	+Input			2.6	pF	
Input Common-Mode Voltage Range				3.8	$\pm\text{V}$	
Common-Mode Rejection Ratio	$V_{\text{CM}} = \pm 2.5$		50	52	dB	
<b>OUTPUT CHARACTERISTICS</b>						
Output Voltage Swing	$R_L = 10\ \Omega, P_D \text{ Package} = 0.7\text{ W}$		$\pm 3.7$	$\pm 3.8$	V	
Output Current			150	175	mA	
Short-Circuit Current				330	mA	
<b>POWER SUPPLY</b>						
Operating Range	$T_{\text{MIN}}$ to $T_{\text{MAX}}$		+5	$\pm 6$	V	
				14	16	mA
Quiescent Current	$T_{\text{MIN}}$ to $T_{\text{MAX}}$			18	mA	
				70		dB
Power Supply Rejection Ratio	$V_S = \pm 4\text{ V to } \pm 6\text{ V}$		64	70	dB	

Specifications subject to change without notice.

# SPECIFICATIONS

(@  $T_A = 25^\circ\text{C}$ ,  $V_S = +5\text{ V}$ ,  $R_L = 100\ \Omega$ , for R Package:  $R_F = 301\ \Omega$  for  $G = +1, +2$ ,  
 $R_F = 200\ \Omega$  for  $G = +10$ ).

Model	Conditions	AD8009AR/JRT			Unit
		Min	Typ	Max	
<b>DYNAMIC PERFORMANCE</b>					
-3 dB Small Signal Bandwidth, $V_O = 0.2\text{ V p-p}$	$G = +1$ , $R_F = 301\ \Omega$		630		MHz
	$G = +2$		430		MHz
Large Signal Bandwidth, $V_O = 2\text{ V p-p}$	$G = +10$		300		MHz
	$G = +2$		365		MHz
Gain Flatness 0.1 dB, $V_O = 0.2\text{ V p-p}$	$G = +10$		250		MHz
	$G = +2$ , $R_L = 150\ \Omega$		65		MHz
Slew Rate	$G = +2$ , $R_L = 150\ \Omega$ , 4 V Step		2,100		V/ $\mu\text{s}$
Settling Time to 0.1%	$G = +2$ , $R_L = 150\ \Omega$ , 2 V Step		10		ns
	$G = +10$ , 2 V Step		25		ns
Rise and Fall Time	$G = +2$ , $R_L = 150\ \Omega$ , 4 V Step		0.725		ns
<b>HARMONIC/NOISE PERFORMANCE</b>					
Second Harmonic $G = +2$ , $V_O = 2\text{ V p-p}$	10 MHz		-74		dBc
	20 MHz		-67		dBc
	70 MHz		-48		dBc
Third Harmonic	10 MHz		-76		dBc
	20 MHz		-72		dBc
	70 MHz		-44		dBc
Input Voltage Noise	$f = 10\text{ MHz}$		1.9		nV/ $\sqrt{\text{Hz}}$
Input Current Noise	$f = 10\text{ MHz}$ , +In		46		pA/ $\sqrt{\text{Hz}}$
	-In		41		pA/ $\sqrt{\text{Hz}}$
<b>DC PERFORMANCE</b>					
Input Offset Voltage			1	4	mV
-Input Bias Current			50	150	$\pm\mu\text{A}$
+Input Bias Voltage			50	150	$\pm\mu\text{A}$
<b>INPUT CHARACTERISTICS</b>					
Input Resistance	+Input		110		k $\Omega$
	-Input		8		$\Omega$
Input Capacitance	+Input		2.6		pF
Input Common-Mode Voltage Range			1.2 to 3.8		V
Common-Mode Rejection Ratio	$V_{CM} = 1.5\text{ V to }3.5\text{ V}$	50	52		dB
<b>OUTPUT CHARACTERISTICS</b>					
Output Voltage Swing			1.1 to 3.9		V
Output Current	$R_L = 10\ \Omega$ , $P_D$ Package = 0.7 W		175		mA
Short-Circuit Current			330		mA
<b>POWER SUPPLY</b>					
Operating Range		+5		$\pm 6$	V
Quiescent Current			10	12	mA
Power Supply Rejection Ratio	$V_S = 4.5\text{ V to }5.5\text{ V}$	64	70		dB

Specifications subject to change without notice.

# AD8009

## ABSOLUTE MAXIMUM RATINGS<sup>1</sup>

Supply Voltage . . . . .	12.6 V
Internal Power Dissipation <sup>2</sup>	
Small Outline Package (R) . . . . .	0.75 W
Input Voltage (Common-Mode) . . . . .	$\pm V_S$
Differential Input Voltage . . . . .	$\pm 3.5 V$
Output Short-Circuit Duration	
. . . . . Observe Power Derating Curves	
Storage Temperature Range R Package . . . .	-65°C to +125°C
Operating Temperature Range (A Grade) . . .	-40°C to +85°C
Operating Temperature Range (J Grade) . . . . .	0°C to 70°C
Lead Temperature Range (Soldering 10 sec) . . . . .	300°C

### NOTES

<sup>1</sup>Stresses above those listed under Absolute Maximum Ratings may cause permanent damage to the device. This is a stress rating only; functional operation of the device at these or any other conditions above those indicated in the operational section of this specification is not implied. Exposure to absolute maximum rating conditions for extended periods may affect device reliability.

<sup>2</sup>Specification is for device in free air:

8-Lead SOIC Package:  $\theta_{JA} = 155^\circ\text{C}/\text{W}$ .

5-Lead SOT-23 Package:  $\theta_{JA} = 240^\circ\text{C}/\text{W}$ .

## MAXIMUM POWER DISSIPATION

The maximum power that can be safely dissipated by the AD8009 is limited by the associated rise in junction temperature. The maximum safe junction temperature for plastic encapsulated devices is determined by the glass transition temperature of the plastic, approximately 150°C. Exceeding this limit temporarily may cause a shift in parametric performance due to a change in the stresses exerted on the die by the package. Exceeding a junction temperature of 175°C for an extended period can result in device failure.

While the AD8009 is internally short circuit protected, this may not be sufficient to guarantee that the maximum junction temperature (150°C) is not exceeded under all conditions. To ensure proper operation, it is necessary to observe the maximum power derating curves.



Figure 3. Plot of Maximum Power Dissipation vs. Temperature

## ORDERING GUIDE

Model	Temperature Range	Package Description	Package Option	Branding
AD8009AR	-40°C to +85°C	8-Lead SOIC	R-8	
AD8009AR-REEL	-40°C to +85°C	8-Lead SOIC	R-8	
AD8009AR-REEL7	-40°C to +85°C	8-Lead SOIC	R-8	
AD8009ARZ*	-40°C to +85°C	8-Lead SOIC	R-8	
AD8009ARZ-REEL*	-40°C to +85°C	8-Lead SOIC	R-8	
AD8009ARZ-REEL7*	-40°C to +85°C	8-Lead SOIC	R-8	
AD8009JRT-R2	0°C to 70°C	5-Lead SOT-23	RT-5	HKJ
AD8009JRT-REEL	0°C to 70°C	5-Lead SOT-23	RT-5	HKJ
AD8009JRT-REEL7	0°C to 70°C	5-Lead SOT-23	RT-5	HKJ
AD8009JRTZ-REEL*	0°C to 70°C	5-Lead SOT-23	RT-5	HKJ
AD8009JRTZ-REEL7*	0°C to 70°C	5-Lead SOT-23	RT-5	HKJ
AD8009ACHIPS		Die		

\*Z = Pb-free part.

## CAUTION

ESD (electrostatic discharge) sensitive device. Electrostatic charges as high as 4000 V readily accumulate on the human body and test equipment and can discharge without detection. Although the AD8009 features proprietary ESD protection circuitry, permanent damage may occur on devices subjected to high energy electrostatic discharges. Therefore, proper ESD precautions are recommended to avoid performance degradation or loss of functionality.



# Typical Performance Characteristics—AD8009



TPC 1. Frequency Response;  $G = +1, +2, +10$ , R and RT Packages

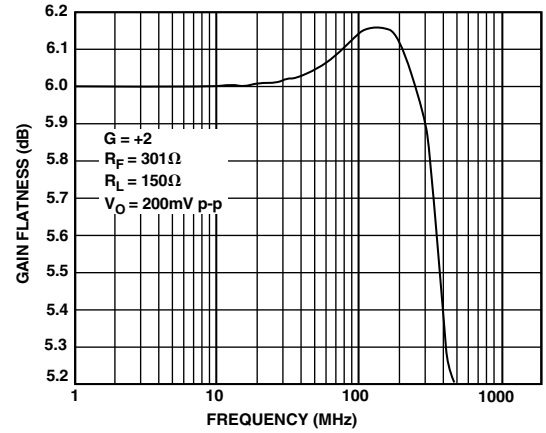

TPC 4. Gain Flatness;  $G = +2$

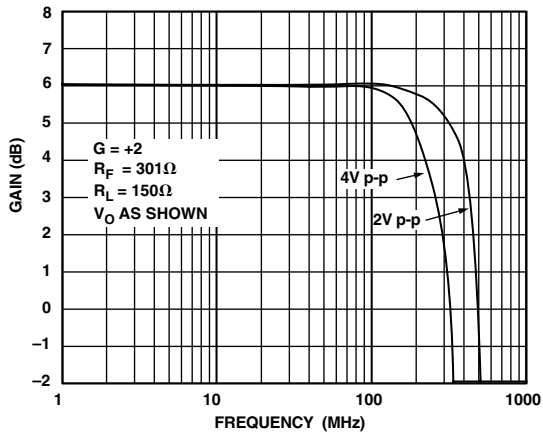

TPC 2. Large Signal Frequency Response;  $G = +2$



TPC 5. Gain Flatness;  $G = +2; V_S = 5\text{V}$

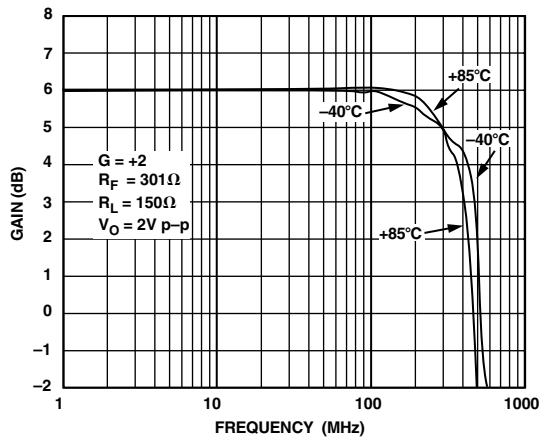

TPC 3. Large Signal Frequency Response vs. Temperature;  $G = +2$

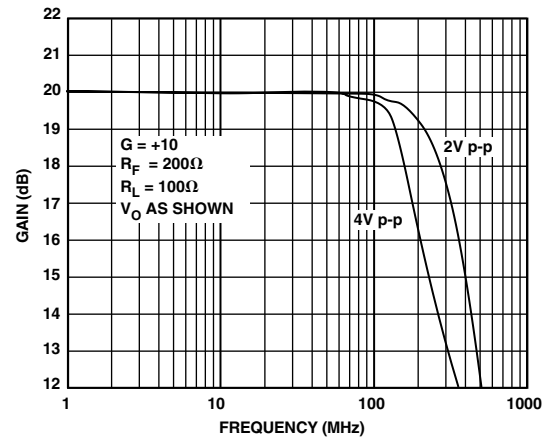

TPC 6. Large Signal Frequency Response;  $G = +10$

# AD8009



TPC 7. Large Signal Frequency Response vs. Temperature;  $G = +10$



TPC 10. Second Harmonic Distortion vs.  $P_{OUT}$ ; ( $G = +10$ )



TPC 8. Distortion vs. Frequency;  $G = +2$



TPC 11. Differential Gain and Phase



TPC 9. Distortion vs. Frequency;  $G = +2$ ;  $V_S = 5 V$



TPC 12. Distortion vs. Frequency;  $G = +10$



TPC 13. Third Harmonic Distortion vs.  $P_{OUT}$ ; ( $G = +10$ )



TPC 16. PSRR vs. Frequency

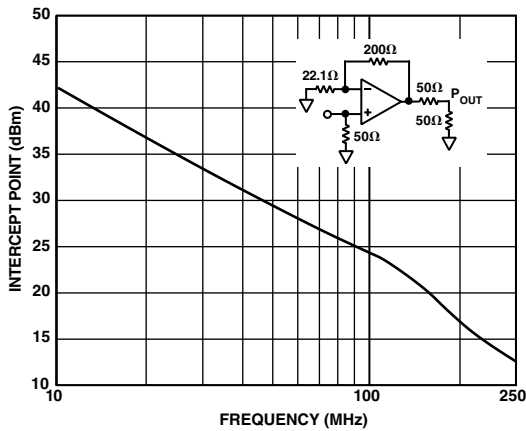

TPC 14. Two Tone, Third Order IMD Intercept vs. Frequency;  $G = +10$



TPC 17. Current Noise vs. Frequency

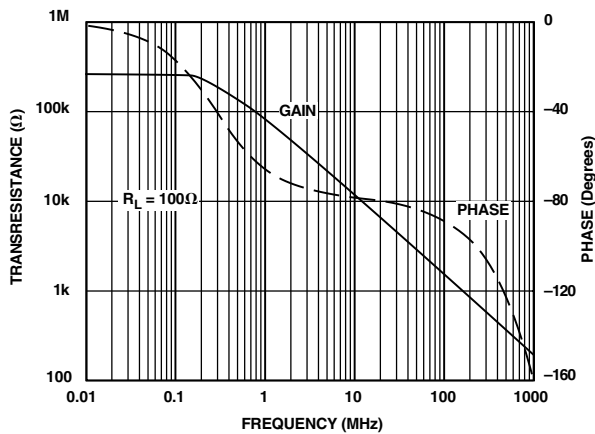

TPC 15. Transresistance and Phase vs. Frequency

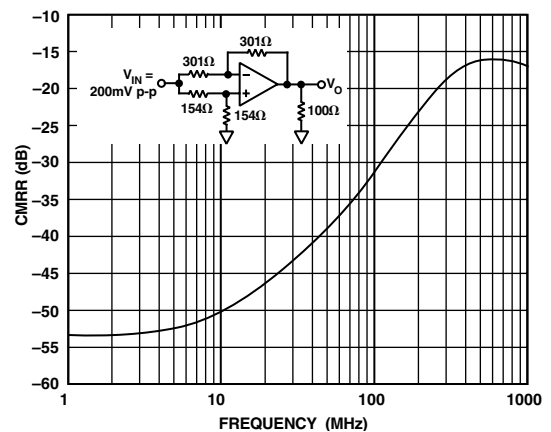

TPC 18. CMRR vs. Frequency



TPC 19. Output Resistance vs. Frequency



TPC 22. Input VSWR;  $G = +10$

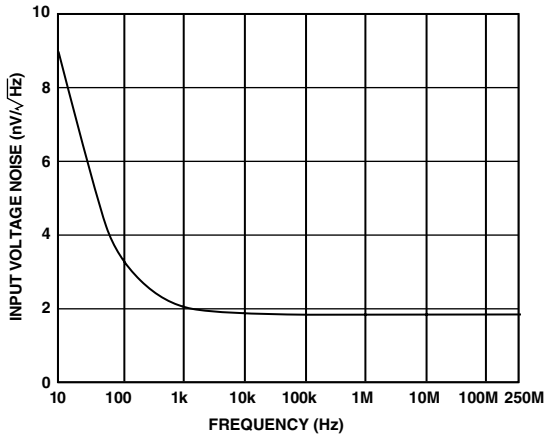

TPC 20. Voltage Noise vs. Frequency

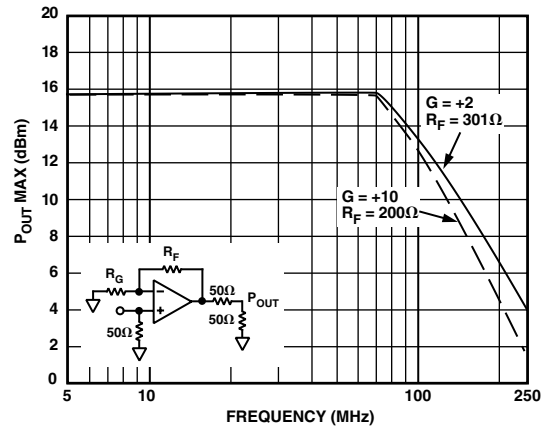

TPC 23. Maximum Output Power vs. Frequency

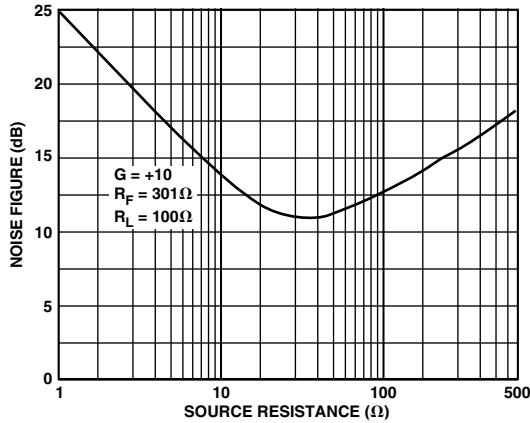

TPC 21. Noise Figure

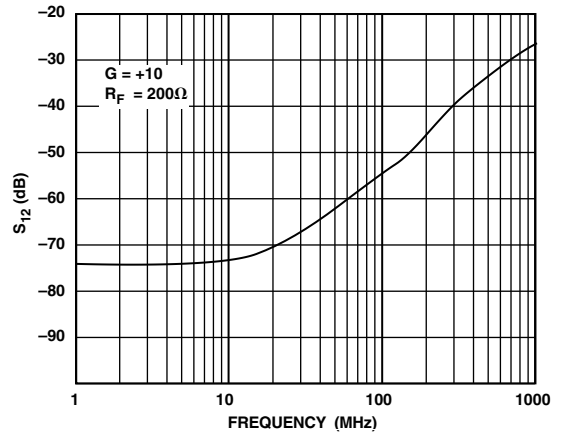

TPC 24. Reverse Isolation ( $S_{12}$ );  $G = +10$





TPC 25. Output VSWR;  $G = +10$



TPC 28. 2 V Transient Response;  $G = +2$



TPC 26. Overdrive Recovery;  $G = +10$

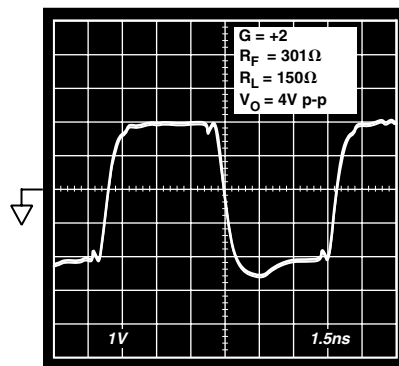

TPC 29. 4 V Transient Response;  $G = +2$



TPC 27. 2 V Transient Response;  $G = +2$



TPC 30. Small Signal Transient Response;  $G = +10$

# AD8009



TPC 31. 2 V Transient Response;  $G = +10$



TPC 34. 2 V Transient Response;  $V_S = 5\text{ V}$ ;  $G = +2$



TPC 32. 4 V Transient Response;  $G = +10$

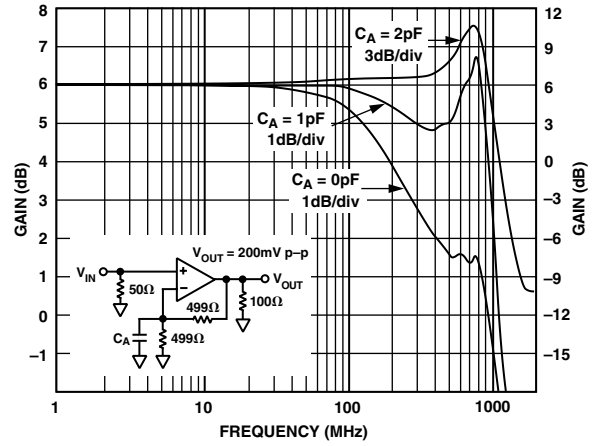

TPC 35. Small Signal Frequency Response vs. Parasitic Capacitance



TPC 33. Small Signal Transient Response;  $V_S = 5\text{ V}$ ;  $G = +2$



TPC 36. Small Signal Pulse Response vs. Parasitic Capacitance



TPC 37. AD8009 Driving a Band-Pass RF Filter

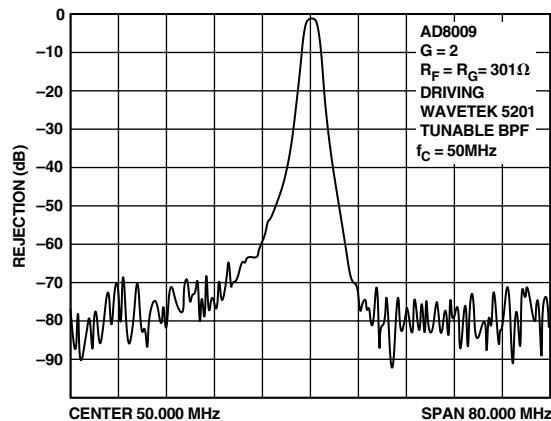

TPC 38. Frequency Response of Band-Pass Filter Circuit

## APPLICATIONS

All current feedback op amps are affected by stray capacitance on their  $-INPUT$ . TPCs 35 and 36 illustrate the AD8009's response to such capacitance.

TPC 35 shows the bandwidth can be extended by placing a capacitor in parallel with the gain resistor. The small signal pulse response corresponding to such an increase in capacitance/bandwidth is shown in TPC 36.

As a practical consideration, the higher the capacitance on the  $-INPUT$  to GND, the higher  $R_F$  needs to be to minimize peaking/ringing.

### RF Filter Driver

The output drive capability, wide bandwidth, and low distortion of the AD8009 are well suited for creating gain blocks that can drive RF filters. Many of these filters require that the input be driven by a  $50\ \Omega$  source, while the output must be terminated in  $50\ \Omega$  for the filters to exhibit their specified frequency response.

TPC 37 shows a circuit for driving and measuring the frequency response of a filter, a Wavetek 5201 tunable band-pass filter that is tuned to a 50 MHz center frequency. The HP8753D network provides a stimulus signal for the measurement. The analyzer has a  $50\ \Omega$  source impedance that drives a cable that is terminated in  $50\ \Omega$  at the high impedance noninverting input of the AD8009.

The AD8009 is set at a gain of +2. The series  $50\ \Omega$  resistor at the output, along with the  $50\ \Omega$  termination provided by the filter and its termination, yield an overall unity gain for the measured path. The frequency response plot of TPC 38 shows the circuit to have an insertion loss of 1.3 dB in the pass band and about 75 dB rejection in the stop band.



Figure 4. Driving an Additional High Resolution Monitor Using Three AD8009s

### RGB Monitor Driver

High resolution computer monitors require very high full power bandwidth signals to maximize their display resolution. The RGB signals that drive these monitors are generally provided by a current-out RAMDAC that can directly drive a 75 Ω doubly terminated line.

There are times when the same output wants to be delivered to additional monitors. The termination provided internally by each monitor prohibits the ability to simply connect a second monitor in parallel with the first. Additional buffering must be provided.

Figure 4 shows a connection diagram for two high resolution monitors being driven by an ADV7160 or ADV7162, a 220 MHz (Megapixel per second) triple RAMDAC. This pixel rate requires a driver whose full power bandwidth is at least half the pixel rate or 110 MHz. This is to provide good resolution for a worst-case signal that swings between zero scale and full scale on adjacent pixels.

The primary monitor is connected in the conventional fashion with a 75 Ω termination to ground at each end of the 75 Ω cable. Sometimes this configuration is called “doubly terminated” and is used when the driver is a high output impedance current source.

For the additional monitor, each of the RGB signals close to the RAMDAC output is applied to a high input impedance, noninverting input of an AD8009 that is configured for a gain of +2. The outputs each drive a series 75 Ω resistor, cable, and termination resistor in the monitor that divides the output signal by two, thus providing an overall unity gain. This scheme is referred to as “back termination” and is used when the driver is a low output impedance voltage source. Back termination requires that the voltage of the signal be double the value that the monitor sees. Double termination requires that the output current be double the value that flows in the monitor termination.

### Driving a Capacitive Load

A capacitive load, like that presented by some A/D converters, can sometimes be a challenge for an op amp to drive depending on the architecture of the op amp. Most of the problem is caused by the pole created by the output impedance of the op amp and the capacitor that is driven. This creates extra phase shift that can eventually cause the op amp to become unstable.

One way to prevent instability and improve settling time when driving a capacitor is to insert a resistor in series between the op amp output and the capacitor. The feedback resistor is still connected directly to the output of the op amp, while the series resistor provides some isolation of the capacitive load from the op amp output.



Figure 5. Capacitive Load Drive Circuit

Figure 5 shows such a circuit with an AD8009 driving a 50 pF load. With  $R_S = 0$ , the AD8009 circuit will be unstable. For a gain of +2 and +10, it was found experimentally that setting  $R_S$  to 42.2  $\Omega$  will minimize the 0.1% settling time with a 2 V step at the output. The 0.1% settling time was measured to be 40 ns with this circuit.

For smaller capacitive loads, a smaller  $R_S$  will yield optimal settling time, while a larger  $R_S$  will be required for larger capacitive loads. Of course, a larger capacitance will always require more time for settling to a given accuracy than a smaller one, and this will be lengthened by the increase in  $R_S$  required. At best, a given RC combination will require about seven time constants by itself to settle to 0.1%, so a limit will be reached where too large a capacitance cannot be driven by a given op amp and still meet the system's required settling time specification.

OUTLINE DIMENSIONS

8-Lead Standard Small Outline Package [SOIC]  
(R-8)

Dimensions shown in millimeters and (inches)



COMPLIANT TO JEDEC STANDARDS MS-012AA  
CONTROLLING DIMENSIONS ARE IN MILLIMETERS; INCH DIMENSIONS  
(IN PARENTHESES) ARE ROUNDED-OFF MILLIMETER EQUIVALENTS FOR  
REFERENCE ONLY AND ARE NOT APPROPRIATE FOR USE IN DESIGN

5-Lead Small Outline Transistor Package [SOT-23]  
(RT-5)

Dimensions shown in millimeters



COMPLIANT TO JEDEC STANDARDS MO-178AA

## Revision History

Location	Page
<b>9/04—Data Sheet changed from REV. E to REV. F.</b>	
Changes to ORDERING GUIDE .....	4
Change to TPC 37 .....	11
<b>3/03—Data Sheet changed from REV. D to REV. E.</b>	
Updated Data Sheet Format .....	Universal
Changes to FEATURES .....	1
Changes to Figure 2 .....	1
Changes to SPECIFICATIONS .....	2
Deleted AD8009EB from ORDERING GUIDE .....	4
Inserted new TPC 5 .....	5
Inserted new TPC 9 .....	6
Inserted new TPC 12 .....	6
Inserted new TPCs 33 and 34 .....	10
Updated OUTLINE DIMENSIONS .....	14