

AD848/AD849

FEATURES

725 MHz Gain Bandwidth – AD849
 175 MHz Gain Bandwidth – AD848
 4.8 mA Supply Current
 300 V/ μ s Slew Rate
 80 ns Settling Time to 0.1% for a 10 V Step – AD849
 Differential Gain: AD848 = 0.07%, AD849 = 0.08%
 Differential Phase: AD848 = 0.08°, AD849 = 0.04°
 Drives Capacitive Loads

DC PERFORMANCE

3 nV/ $\sqrt{\text{Hz}}$ Input Voltage Noise – AD849
 85 V/mV Open Loop Gain into a 1 k Ω Load – AD849
 1 mV max Input Offset Voltage
 Performance Specified for ± 5 V and ± 15 V Operation
 Available in Plastic, Hermetic Cerdip and Small Outline
 Packages. Chips and MIL-STD-883B Parts Available.
 Available in Tape and Reel in Accordance with
 EIA-481A Standard

APPLICATIONS

Cable Drivers
 8- and 10-Bit Data Acquisition Systems
 Video and R_F Amplification
 Signal Generators

PRODUCT DESCRIPTION

The AD848 and AD849 are high speed, low power monolithic operational amplifiers. The AD848 is internally compensated so that it is stable for closed loop gains of 5 or greater. The AD849 is fully decompensated and is stable at gains greater than 24. The AD848 and AD849 achieve their combination of fast ac and good dc performance by utilizing Analog Devices' junction isolated complementary bipolar (CB) process. This process enables these op amps to achieve their high speed while only requiring 4.8 mA of current from the power supplies.

The AD848 and AD849 are members of Analog Devices' family of high speed op amps. This family includes, among others, the AD847 which is unity gain stable, with a gain bandwidth of 50 MHz. For more demanding applications, the AD840, AD841 and AD842 offer even greater precision and greater output current drive.

The AD848 and AD849 have good dc performance. When operating with ± 5 V supplies, they offer open loop gains of 13 V/mV (AD848 with a 500 Ω load) and low input offset voltage of 1 mV maximum. Common-mode rejection is a minimum of 92 dB. Output voltage swing is ± 3 V even into loads as low as 150 Ω .

REV. B

Information furnished by Analog Devices is believed to be accurate and reliable. However, no responsibility is assumed by Analog Devices for its use, nor for any infringements of patents or other rights of third parties which may result from its use. No license is granted by implication or otherwise under any patent or patent rights of Analog Devices.

CONNECTION DIAGRAMS

Plastic (N),
 Small Outline (R) and
 Cerdip (Q) Packages

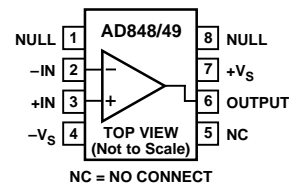

20-Terminal LCC Pinout

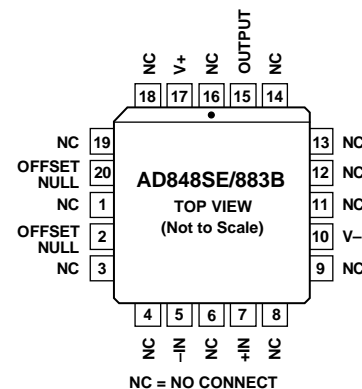

APPLICATIONS HIGHLIGHTS

1. The high slew rate and fast settling time of the AD848 and AD849 make them ideal for video instrumentation circuitry, low noise pre-amps and line drivers.
2. In order to meet the needs of both video and data acquisition applications, the AD848 and AD849 are optimized and tested for ± 5 V and ± 15 V power supply operation.
3. Both amplifiers offer full power bandwidth greater than 20 MHz (for 2 V p-p with ± 5 V supplies).
4. The AD848 and AD849 remain stable when driving any capacitive load.
5. Laser wafer trimming reduces the input offset voltage to 1 mV maximum on all grades, thus eliminating the need for external offset nulling in many applications.
6. The AD848 is an enhanced replacement for the LM6164 series and can function as a pin-for-pin replacement for many high speed amplifiers such as the HA2520/2/5 and EL2020 in applications where the gain is 5 or greater.

AD848/AD849—SPECIFICATIONS (@ T_A = +25°C, unless otherwise noted)

Model	Conditions	V _S	AD848J			AD848A/S			Units
			Min	Typ	Max	Min	Typ	Max	
INPUT OFFSET VOLTAGE ¹ Offset Drift	T _{MIN} to T _{MAX}	±5 V	0.2	1		0.2	1	mV	
		±15 V	0.5	2.3		0.5	2.3	mV	
		±5 V			1.5		2	mV	
		±15 V			3.0		3.5	mV	
		±5 V, ±15 V	7			7		μV/°C	
INPUT BIAS CURRENT	T _{MIN} to T _{MAX}	±5 V, ±15 V ±5 V, ±15 V	3.3	6.6		3.3	6.6/5 7.5	μA μA	
INPUT OFFSET CURRENT Offset Current Drift	T _{MIN} to T _{MAX}	±5 V, ±15 V ±5 V, ±15 V ±5 V, ±15 V	50	300 400		50	300 400	nA nA nA/°C	
OPEN LOOP GAIN	V _O = ±2.5 V R _{LOAD} = 500 Ω T _{MIN} to T _{MAX} R _{LOAD} = 150 Ω V _{OUT} = ±10 V R _{LOAD} = 1 kΩ T _{MIN} to T _{MAX}	±5 V	9	13		9	13	V/mV V/mV	
			7		8		8	V/mV	
		±15 V	12	20		12	20	V/mV V/mV	
			8				8/6		
DYNAMIC PERFORMANCE	Gain Bandwidth	A _{VCL} ≥ 5		125		125		MHz	
		±15 V		175		175		MHz	
	Full Power Bandwidth ²	V _O = 2 V p-p, R _L = 500 Ω	±5 V		24		24		MHz
		V _O = 20 V p-p, R _L = 1 kΩ	±15 V		4.7		4.7		MHz
	Slew Rate	R _{LOAD} = 1 kΩ	±5 V		200		200		V/μs
		-2.5 V to +2.5 V 10 V Step, A _V = -4	±15 V	225	300		225	300	V/μs
Settling Time to 0.1%	C _{LOAD} = 10 pF R _{LOAD} = 1 kΩ	±5 V		65		65		ns	
		±15 V		100		100		ns	
Phase Margin		±15 V		60		60		Degrees	
DIFFERENTIAL GAIN	f = 4.4 MHz	±15 V		0.07		0.07		%	
DIFFERENTIAL PHASE	f = 4.4 MHz	±15 V		0.08		0.08		Degree	
COMMON-MODE REJECTION	V _{CM} = ±2.5 V V _{CM} = ±12 V T _{MIN} to T _{MAX}	±5 V	92	105		92	105	dB	
		±15 V	92	105		92	105	dB	
			88			88		dB	
POWER SUPPLY REJECTION	V _S = ±4.5 V to ±18 V T _{MIN} to T _{MAX}		85	98		85	98	dB	
			80			80		dB	
INPUT VOLTAGE NOISE	f = 10 kHz	±15 V		5		5		nV/√Hz	
INPUT CURRENT NOISE	f = 10 kHz	±15 V		1.5		1.5		pA/√Hz	
INPUT COMMON-MODE VOLTAGE RANGE		±5 V		+4.3 -3.4		+4.3 -3.4		V V	
		±15 V		+14.3 -13.4		+14.3 -13.4		V V	
OUTPUT VOLTAGE SWING	R _{LOAD} = 500 Ω R _{LOAD} = 150 Ω R _{LOAD} = 50 Ω R _{LOAD} = 1 kΩ R _{LOAD} = 500 Ω	±5 V	3.0	3.6		3.0	3.6	±V	
		±5 V	2.5	3		2.5	3	±V	
		±5 V		1.4			1.4	±V	
		±15 V	12			12		±V	
		±15 V	10			10		±V	
SHORT CIRCUIT CURRENT		±15 V		32		32		mA	
INPUT RESISTANCE				70		70		kΩ	
INPUT CAPACITANCE				1.5		1.5		pF	
OUTPUT RESISTANCE	Open Loop			15		15		Ω	
POWER SUPPLY Operating Range Quiescent Current	T _{MIN} to T _{MAX} T _{MIN} to T _{MAX}	±5 V	±4.5	±18		±4.5	±18	V	
		±5 V		4.8	6.0		4.8	6.0	mA
		±15 V		5.1	6.8		5.1	7.4/8.3	mA
		±15 V			8.0			8.0/9.0	mA

NOTES

¹Input offset voltage specifications are guaranteed after 5 minutes at T_A = +25°C.

²Full power bandwidth = slew rate/2 π V_{PEAK}. Refer to Figure 1.

All min and max specifications are guaranteed. Specifications in **boldface** are tested on all production units at final electrical test. All others are guaranteed but not necessarily tested. Specifications subject to change without notice.

Model	Conditions	V _S	AD849J			AD849A/S			Units
			Min	Typ	Max	Min	Typ	Max	
INPUT OFFSET VOLTAGE ¹	T _{MIN} to T _{MAX}	±5 V	0.3	1		0.1	0.75	mV	
		±15 V	0.3	1		0.1	0.75	mV	
		±5 V			1.3		1.0	mV	
		±15 V			1.3		1.0	mV	
		±5 V, ±15 V	2			2			μV/°C
Offset Drift									
INPUT BIAS CURRENT	T _{MIN} to T _{MAX}	±5 V, ±15 V	3.3	6.6		3.3	6.6/5	μA	
		±5 V, ±15 V		7.2			7.5	μA	
INPUT OFFSET CURRENT	T _{MIN} to T _{MAX}	±5 V, ±15 V	50	300		50	300	nA	
		±5 V, ±15 V		400			400	nA	
Offset Current Drift		±5 V, ±15 V	0.3			0.3		nA/°C	
OPEN LOOP GAIN	V _O = ±2.5 V R _{LOAD} = 500 Ω T _{MIN} to T _{MAX} R _{LOAD} = 150 Ω V _{OUT} = ±10 V R _{LOAD} = 1 kΩ T _{MIN} to T _{MAX}	±5 V	30	50		30	50	V/mV	
			20			20/15		V/mV	
				32			32		V/mV
		±15 V	45	85		45	85		V/mV
			30			30/25			V/mV
DYNAMIC PERFORMANCE									
Gain Bandwidth	A _{VCL} ≥ 25	±5 V		520			520	MHz	
		±15 V		725			725	MHz	
Full Power Bandwidth ²	V _O = 2 V p-p, R _L = 500 Ω	±5 V		20			20	MHz	
	V _O = 20 V p-p, R _L = 1 kΩ	±15 V		4.7			4.7	MHz	
Slew Rate		±5 V		200			200	V/μs	
	R _{LOAD} = 1 kΩ	±15 V	225	300		225	300	V/μs	
Settling Time to 0.1%	-2.5 V to +2.5 V 10 V Step, A _V = -24	±5 V		65			65	ns	
		±15 V		80			80	ns	
Phase Margin	C _{LOAD} = 10 pF R _{LOAD} = 1 kΩ	±15 V		60			60	Degrees	
DIFFERENTIAL GAIN	f = 4.4 MHz	±15 V		0.08			0.08	%	
DIFFERENTIAL PHASE	f = 4.4 MHz	±15 V		0.04			0.04	Degrees	
COMMON-MODE REJECTION	V _{CM} = ±2.5 V V _{CM} = ±12 V T _{MIN} to T _{MAX}	±5 V	100	115		100	115	dB	
		±15 V	100	115		100	115	dB	
			96			96		dB	
POWER SUPPLY REJECTION	V _S = ±4.5 V to ±18 V T _{MIN} to T _{MAX}	±5 V	98	120		98	120	dB	
		±15 V	94			94		dB	
INPUT VOLTAGE NOISE	f = 10 kHz	±15 V		3			3	nV/√Hz	
INPUT CURRENT NOISE	f = 10 kHz	±15 V		1.5			1.5	pA/√Hz	
INPUT COMMON-MODE VOLTAGE RANGE		±5 V		+4.3			+4.3	V	
				-3.4			-3.4	V	
		±15 V		+14.3			+14.3	V	
				-13.4			-13.4	V	
OUTPUT VOLTAGE SWING	R _{LOAD} = 500 Ω R _{LOAD} = 150 Ω R _{LOAD} = 50 Ω R _{LOAD} = 1 kΩ R _{LOAD} = 500 Ω	±5 V	3.0	3.6		3.0	3.6	±V	
		±5 V	2.5	3		2.5	3	±V	
		±5 V		1.4			1.4	±V	
		±15 V	12			12		±V	
		±15 V	10			10		±V	
SHORT CIRCUIT CURRENT		±15 V		32			32	mA	
INPUT RESISTANCE				25			25	kΩ	
INPUT CAPACITANCE				1.5			1.5	pF	
OUTPUT RESISTANCE	Open Loop			15			15	Ω	
POWER SUPPLY	Operating Range Quiescent Current	±5 V	±4.5		±18		±4.5	±18	V
		T _{MIN} to T _{MAX}		4.8	6.0		4.8	6.0	mA
				7.4			7.4/8.3		mA
	T _{MIN} to T _{MAX}	±15 V		5.1	6.8		5.1	6.8	mA
								8.0/9.0	mA

NOTES

¹Input offset voltage specifications are guaranteed after 5 minutes at T_A = +25°C.

²Full power bandwidth = slew rate/2πV_{PEAK}. Refer to Figure 1.

All min and max specifications are guaranteed. Specifications in **boldface** are tested on all production units at final electrical test. All others are guaranteed but not necessarily tested. Specifications subject to change without notice.

AD848/AD849

ABSOLUTE MAXIMUM RATINGS¹

Supply Voltage	±18 V
Internal Power Dissipation ²	
Plastic (N)	1.1 Watts
Small Outline (R)	0.9 Watts
Cerdip (Q)	1.1 Watts
LCC (E)	0.8 Watts
Input Voltage	±V _S
Differential Input Voltage	±6 V
Storage Temperature Range (Q)	-65°C to +150°C
(N, R)	-65°C to +125°C
Junction Temperature	+175°C
Lead Temperature Range (Soldering 60 sec)	+300°C

NOTES

¹Stresses above those listed under "Absolute Maximum Ratings" may cause permanent damage to the device. This is a stress rating only, and functional operation of the device at these or any other conditions above those indicated in the operational section of this specification is not implied. Exposure to absolute maximum rating conditions for extended periods may affect device reliability.

²LCC: $\theta_{JA} = 150^{\circ}\text{C}/\text{Watt}$

Mini-DIP Package: $\theta_{JA} = 110^{\circ}\text{C}/\text{Watt}$

Cerdip Package: $\theta_{JA} = 110^{\circ}\text{C}/\text{Watt}$

Small Outline Package: $\theta_{JA} = 155^{\circ}\text{C}/\text{Watt}$.

METALIZATION PHOTOGRAPH

Contact factory for latest dimensions. (AD848 and AD849 are identical except for the part number in the upper right.)
Dimensions shown in inches and (mm).

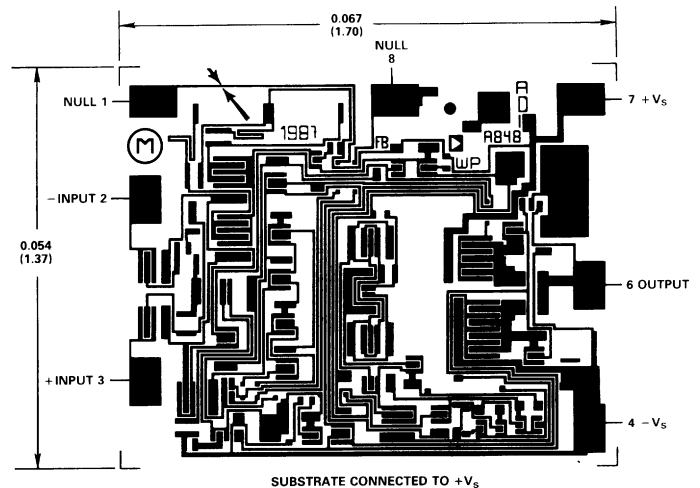

ORDERING GUIDE

Model	Gain Bandwidth MHz	Min Stable Gain	Max Offset Voltage mV	Temperature Range - °C	Package Option ¹
AD848JN	175	5	1	0 to +70	N-8
AD848JR ²	175	5	1	0 to +70	R-8
AD848JCHIPS	175	5	1	0 to +70	Die Form
AD848AQ	175	5	1	-40 to +85	Q-8
AD848SQ	175	5	1	-55 to +125	Q-8
AD848SQ/883B	175	5	1	-55 to +125	Q-8
AD848SE/883B	175	5	1	-55 to +125	E-20A
AD849JN	725	25	1	0 to +70	N-8
AD849JR ²	725	25	1	0 to +70	R-8
AD849AQ	725	25	0.75	-40 to +85	Q-8
AD849SQ	725	25	0.75	-55 to +125	Q-8
AD849SQ/883B	725	25	0.75	-55 to +125	Q-8
AD847J/A/S	50	1	1	See AD847 Data Sheet	

NOTES

¹E = LCC; N = Plastic DIP; Q = Cerdip; R = Small Outline IC (SOIC).

²Plastic SOIC (R) available in tape and reel. AD848 available in S grade chips. AD849 available in J and S grade chips.



Figure 1. AD848 Inverting Amplifier Configuration



Figure 2. AD849 Inverting Amplifier Configuration



Figure 1a. AD848 Large Signal Pulse Response



Figure 2a. AD849 Large Signal Pulse Response

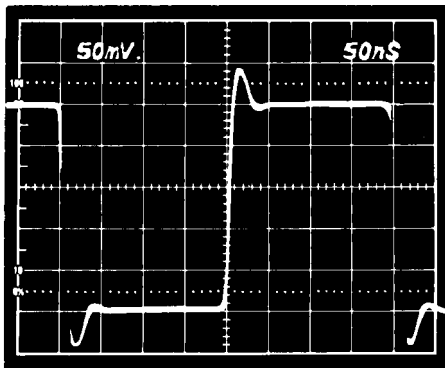

Figure 1b. AD848 Small Signal Pulse Response

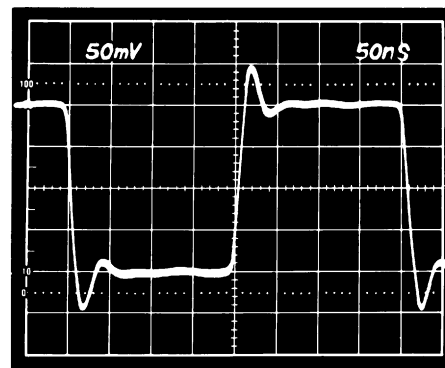

Figure 2b. AD849 Small Signal Pulse Response

OFFSET NULLING

The input voltage of the AD848 and AD849 are very low for high speed op amps, but if additional nulling is required, the circuit shown in Figure 3 can be used.

For high performance circuits it is recommended that a resistor (R_B in Figures 1 and 2) be used to reduce bias current errors by matching the impedance at each input. The offset voltage error caused by the input currents is decreased by more than an order of magnitude.

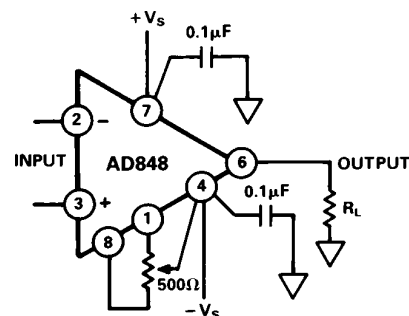

Figure 3. Offset Nulling

AD848/AD849—Typical Characteristics (@ $T_A = +25^\circ\text{C}$ and $V_S = \pm 15\text{ V}$, unless otherwise noted)

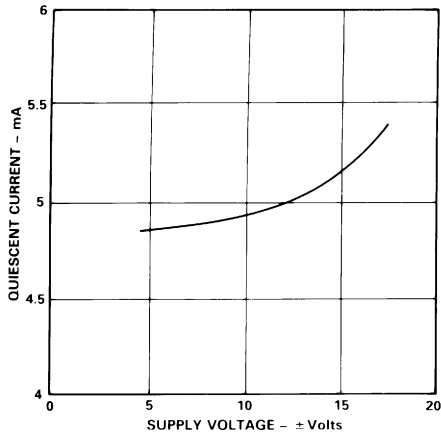

Figure 4. Quiescent Current vs. Supply Voltage (AD848 and AD849)

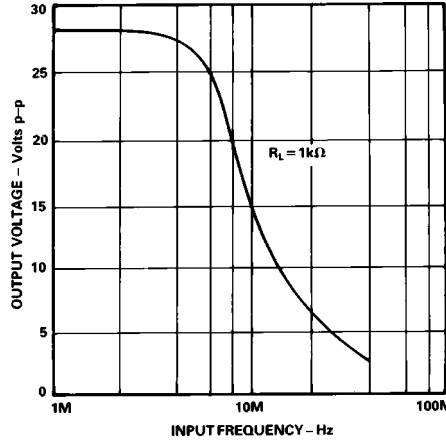

Figure 5. Large Signal Frequency Response (AD848 and AD849)

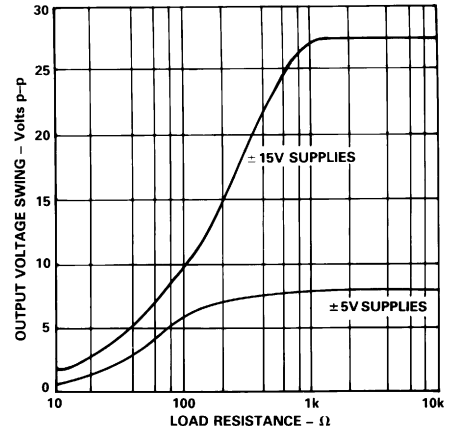

Figure 6. Output Voltage Swing vs. Load Resistance (AD848 and AD849)

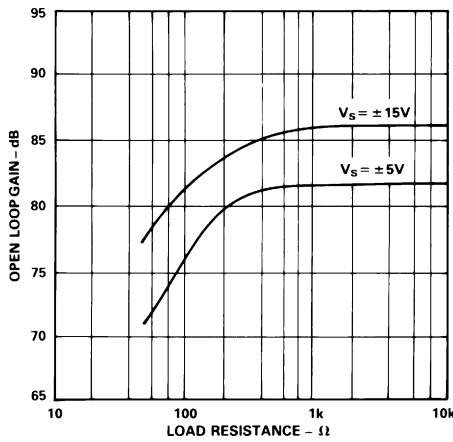

Figure 7. Open Loop Gain vs. Load Resistance (AD848)

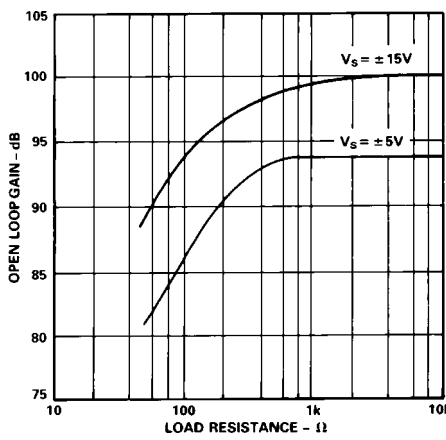

Figure 8. Open Loop Gain vs. Load Resistance (AD849)

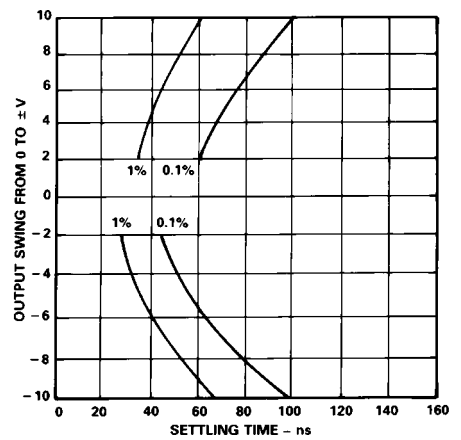

Figure 9. Output Swing and Error vs. Settling Time (AD848)



Figure 10. Quiescent Current vs. Temperature (AD848 and AD849)

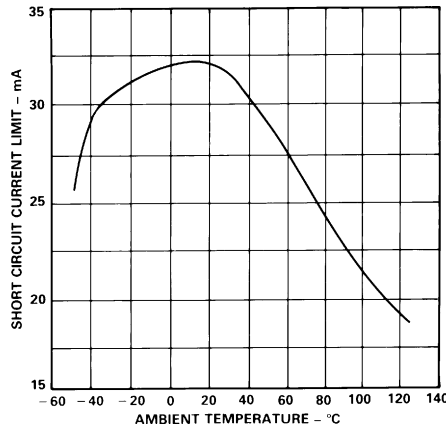

Figure 11. Short Circuit Current Limit vs. Temperature (AD848 and AD849)

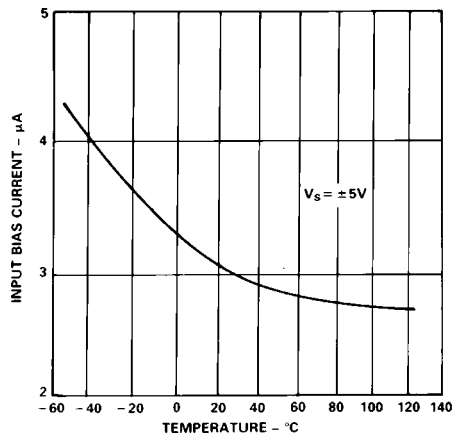

Figure 12. Input Bias Current vs. Temperature (AD848 and AD849)

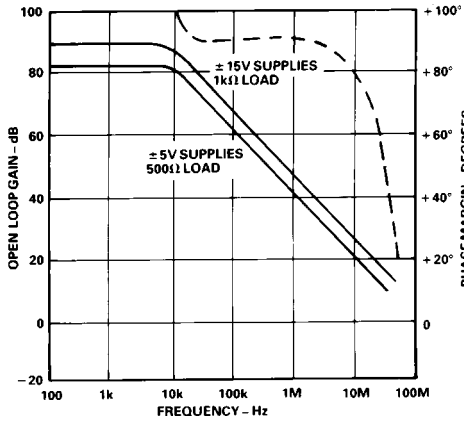

Figure 13. Open Loop Gain and Phase Margin vs. Frequency (AD848)

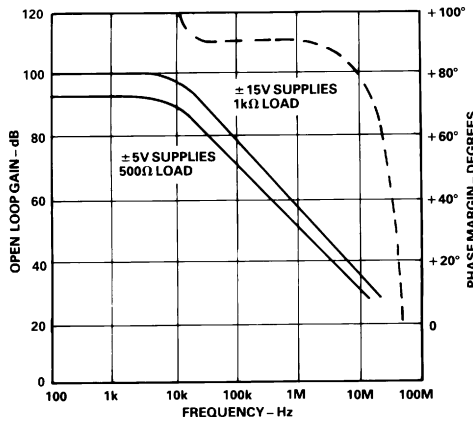

Figure 14. Open Loop Gain and Phase Margin vs. Frequency (AD849)

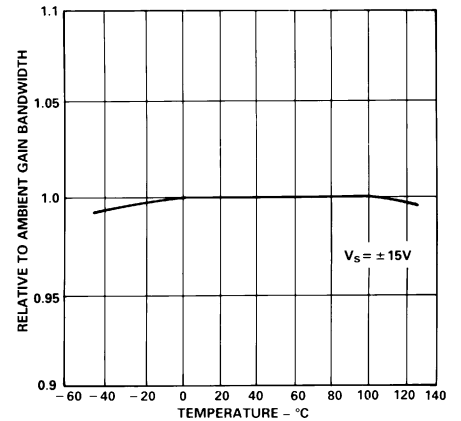

Figure 15. Normalized Gain Bandwidth Product vs. Temperature (AD848 and AD849)

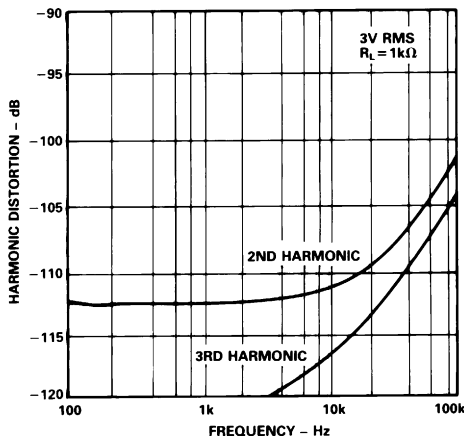

Figure 16. Harmonic Distortion vs. Frequency (AD848)

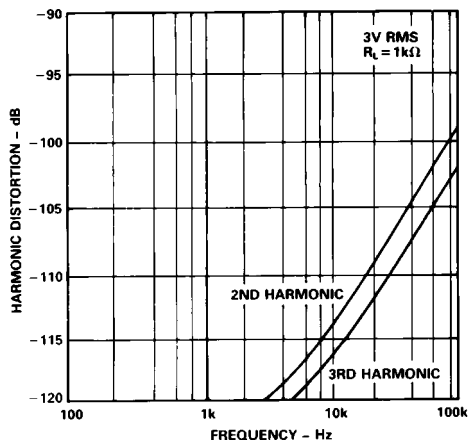

Figure 17. Harmonic Distortion vs. Frequency (AD849)

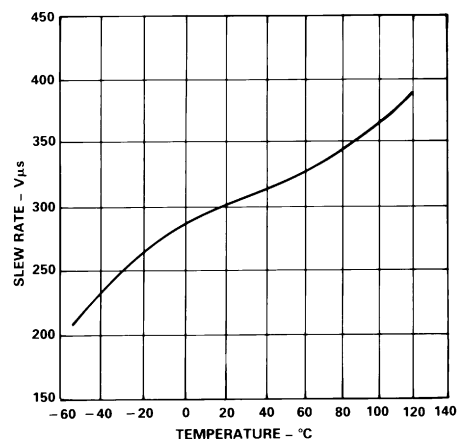

Figure 18. Slew Rate vs. Temperature (AD848 and AD849)

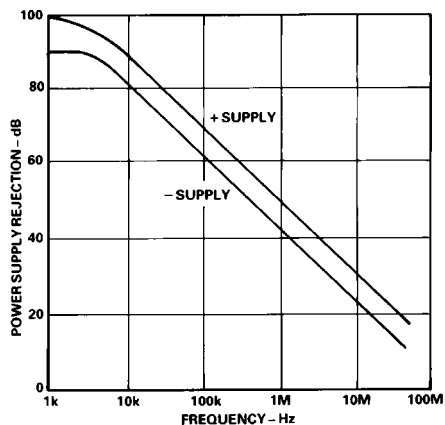

Figure 19. Power Supply Rejection vs. Frequency (AD848)

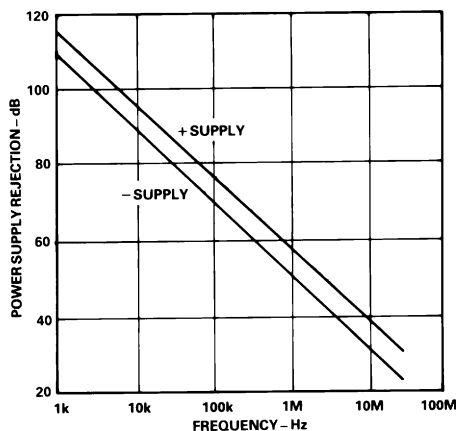

Figure 20. Power Supply Rejection vs. Frequency (AD849)

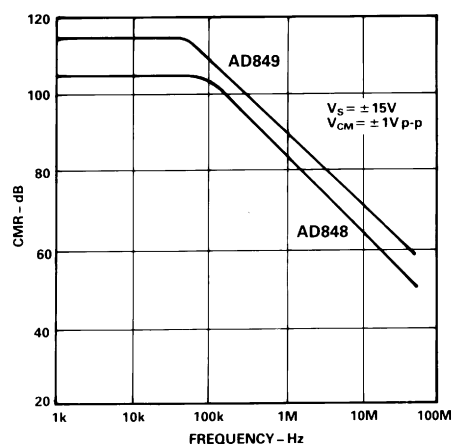

Figure 21. Common-Mode Rejection vs. Frequency