

FEATURES

- Micropower at high voltage (18 V): 22 μ A maximum**
- Low input bias current: 20 pA maximum**
- Gain bandwidth product: 240 kHz at $A_v = 100$ typical**
- Unity-gain crossover: 240 kHz**
- 3 dB closed-loop bandwidth: 310 kHz**
- Slew rate: 80 V/ms**
- Large signal voltage gain: 110 dB minimum**
- Single-supply operation: 2.7 V to 18 V**
- Dual-supply operation: ± 1.35 V to ± 9 V**
- Unity-gain stable**
- Excellent electromagnetic interference immunity**

APPLICATIONS

- Portable medical equipment**
- Remote sensors**
- Transimpedance amplifiers**
- Current monitors**
- 4 mA to 20 mA loop drivers**
- Buffer/level shifting**

GENERAL DESCRIPTION

The AD8546 and AD8548 are dual and quad micropower, high input impedance amplifiers optimized for low power and wide operating supply voltage range applications.

The AD8546/AD8548 rail-to-rail input/output (RRIO) feature provides increased dynamic range to drive low frequency data converters, making these amplifiers ideal for dc gain and buffering of sensor front ends or high impedance input sources used in wireless or remote sensors or transmitters. The AD8546/AD8548 also have high immunity to electromagnetic interference.

The low supply current specification (22 μ A) of the AD8546/AD8548 over a wide operating voltage range of 2.7 V to 18 V or dual supplies (± 1.35 V to ± 9 V) makes these amplifiers useful for a variety of battery-powered, portable applications, such as ECGs, pulse monitors, glucose meters, smoke and fire detectors, vibration monitors, and backup battery sensors.

The AD8546/AD8548 are specified over the extended industrial temperature range of -40°C to $+125^\circ\text{C}$. The AD8546 is available in an 8-lead MSOP package; the AD8548 is available in a 14-lead SOIC_N package.

PIN CONFIGURATIONS



Figure 1. AD8546 (8-Lead MSOP)

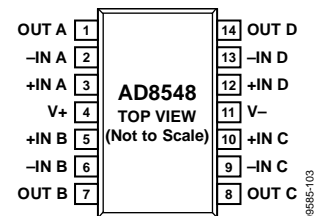

Figure 2. AD8548 (14-Lead SOIC_N)

Table 1. Micropower Op Amps (<250 μ A Typical)¹

Amplifier	Supply Voltage		
	5 V	12 V to 18 V	36 V
Single	AD8500 AD8505 AD8541 AD8603 ADA4505-1	AD8663	
Dual	AD8502 AD8506 AD8542 AD8607 ADA4505-2	AD8546 AD8657 AD8667 OP281	ADA4062-2 ADA4096-2
Quad	AD8504 AD8508 AD8544 AD8609 ADA4505-4	AD8548 AD8669 OP481 AD8659	ADA4062-4 ADA4096-4

¹ See www.analog.com for the latest selection of micropower op amps.

TABLE OF CONTENTS

Features	1	Typical Performance Characteristics	7
Applications	1	Applications Information	17
Pin Configurations	1	Input Stage	17
General Description	1	Output Stage	18
Revision History	2	Rail-to-Rail Input and Output	18
Specifications	3	Resistive Load	18
Electrical Characteristics—18 V Operation	3	Comparator Operation	19
Electrical Characteristics—10 V Operation	4	EMI Rejection Ratio	20
Electrical Characteristics—2.7 V Operation	5	4 mA to 20 mA Process Control Current Loop Transmitter	20
Absolute Maximum Ratings	6	Outline Dimensions	21
Thermal Resistance	6	Ordering Guide	21
ESD Caution	6		

REVISION HISTORY

9/12—Rev. B to Rev. C

Changes to Features Section, General Description Section, and Table 1	1
Changes to Table 2	3
Changes to Table 3	4
Changes to Table 4	5
Added EMI Rejection Ration Section	20

4/12—Rev. A to Rev. B

Added AD8548 and 14-Lead SOIC	Universal
Changes to Product Title, Features Section, General Description Section, and Table 1	1
Added Figure 2; Renumbered Figures Sequentially	1
Moved Electrical Characteristics—18 V Operation Section	3
Changes to Table 2	3
Changes to Table 3	4
Moved Electrical Characteristics—2.7 V Operation Section	5

Changes to Table 4	5
Changes to Table 6	6
Changes to Figure 4, Figure 5, Figure 7, and Figure 8	7
Deleted Figure 8 and Figure 11	8
Changes to Figure 9, Figure 10, Figure 12, and Figure 13	8
Changes to Figure 22 and Figure 25	10
Changes to Figure 33	12
Changes to Figure 63 and Figure 64	18
Updated Outline Dimensions	21
Added Figure 72	21
Changes to Ordering Guide	21

4/11—Rev. 0 to Rev. A

Changes to Product Title, Features Section, Applications Section, General Description Section, and Table 1	1
--	---

1/11—Revision 0: Initial Version

SPECIFICATIONS

ELECTRICAL CHARACTERISTICS—18 V OPERATION

$V_{SY} = 18\text{ V}$, $V_{CM} = V_{SY}/2$, $T_A = 25^\circ\text{C}$, unless otherwise noted.

Table 2.

Parameter	Symbol	Test Conditions/Comments	Min	Typ	Max	Unit
INPUT CHARACTERISTICS						
Offset Voltage	V_{OS}	$V_{CM} = 0\text{ V to }18\text{ V}$			3	mV
		$V_{CM} = 0.3\text{ V to }17.7\text{ V}; -40^\circ\text{C} \leq T_A \leq +125^\circ\text{C}$			7	mV
		$V_{CM} = 0\text{ V to }18\text{ V}; -40^\circ\text{C} \leq T_A \leq +125^\circ\text{C}$			12	mV
Offset Voltage Drift	$\Delta V_{OS}/\Delta T$			3		$\mu\text{V}/^\circ\text{C}$
Input Bias Current	I_B	$-40^\circ\text{C} \leq T_A \leq +125^\circ\text{C}$		5	20	pA
Input Offset Current	I_{OS}	$-40^\circ\text{C} \leq T_A \leq +125^\circ\text{C}$			40	pA
		$-40^\circ\text{C} \leq T_A \leq +125^\circ\text{C}$			5.2	nA
Input Voltage Range	IVR		0		18	V
Common-Mode Rejection Ratio	CMRR	$V_{CM} = 0\text{ V to }18\text{ V}$	74	95		dB
		$V_{CM} = 0.3\text{ V to }17.7\text{ V}; -40^\circ\text{C} \leq T_A \leq +125^\circ\text{C}$	68			dB
		$V_{CM} = 0\text{ V to }18\text{ V}; -40^\circ\text{C} \leq T_A \leq +125^\circ\text{C}$	65			dB
Large Signal Voltage Gain	A_{VO}	$R_L = 100\text{ k}\Omega; V_O = 0.5\text{ V to }17.5\text{ V}$	110	125		dB
		$-40^\circ\text{C} \leq T_A \leq +125^\circ\text{C}$	105			dB
Input Resistance	R_{IN}			10		G Ω
Input Capacitance	C_{INDM}			11		pF
				3.5		pF
OUTPUT CHARACTERISTICS						
Output Voltage High	V_{OH}	$R_L = 100\text{ k}\Omega$ to $V_{CM}; -40^\circ\text{C} \leq T_A \leq +125^\circ\text{C}$	17.97			V
Output Voltage Low	V_{OL}	$R_L = 100\text{ k}\Omega$ to $V_{CM}; -40^\circ\text{C} \leq T_A \leq +125^\circ\text{C}$			30	mV
Short-Circuit Current	I_{SC}			± 12		mA
Closed-Loop Output Impedance	Z_{OUT}	$f = 1\text{ kHz}; A_V = +1$		15		Ω
POWER SUPPLY						
Power Supply Rejection Ratio	PSRR	$V_{SY} = 2.7\text{ V to }18\text{ V}$	95	115		dB
		$-40^\circ\text{C} \leq T_A \leq +125^\circ\text{C}$	90			dB
Supply Current per Amplifier	I_{SY}	$I_O = 0\text{ mA}$		18	22	μA
		$-40^\circ\text{C} \leq T_A \leq +125^\circ\text{C}$			33	μA
DYNAMIC PERFORMANCE						
Slew Rate	SR	$R_L = 1\text{ M}\Omega; C_L = 10\text{ pF}; A_V = +1$		80		V/ms
Settling Time to 0.1%	t_s	$V_{IN} = 1\text{ V step}; R_L = 100\text{ k}\Omega; C_L = 10\text{ pF}$		15		μs
Unity Gain Crossover	UGC	$V_{IN} = 10\text{ mV p-p}; R_L = 1\text{ M}\Omega; C_L = 10\text{ pF}; A_V = +1$		240		kHz
Phase Margin	Φ_M	$V_{IN} = 10\text{ mV p-p}; R_L = 1\text{ M}\Omega; C_L = 10\text{ pF}; A_V = +1$		60		Degrees
Gain Bandwidth Product	GBP	$V_{IN} = 10\text{ mV p-p}; R_L = 1\text{ M}\Omega; C_L = 10\text{ pF}; A_V = +100$		240		kHz
-3 dB Closed-Loop Bandwidth	$f_{-3\text{dB}}$	$V_{IN} = 10\text{ mV p-p}; R_L = 1\text{ M}\Omega; C_L = 10\text{ pF}; A_V = +1$		310		kHz
Channel Separation	CS	$f = 10\text{ kHz}; R_L = 1\text{ M}\Omega$		105		dB
EMI Rejection Ratio of +IN x	EMIRR	$V_{IN} = 100\text{ mV p-p}; f = 400\text{ MHz}, 900\text{ MHz}, 1800\text{ MHz}, 2400\text{ MHz}$		90		dB
NOISE PERFORMANCE						
Voltage Noise	e_n p-p	$f = 0.1\text{ Hz to }10\text{ Hz}$		5		$\mu\text{V p-p}$
Voltage Noise Density	e_n	$f = 1\text{ kHz}$		50		$\text{nV}/\sqrt{\text{Hz}}$
		$f = 10\text{ kHz}$		45		$\text{nV}/\sqrt{\text{Hz}}$
Current Noise Density	i_n	$f = 1\text{ kHz}$		0.1		$\text{pA}/\sqrt{\text{Hz}}$

ELECTRICAL CHARACTERISTICS—10 V OPERATION

$V_{SY} = 10\text{ V}$, $V_{CM} = V_{SY}/2$, $T_A = 25^\circ\text{C}$, unless otherwise noted.

Table 3.

Parameter	Symbol	Test Conditions/Comments	Min	Typ	Max	Unit
INPUT CHARACTERISTICS						
Offset Voltage	V_{OS}	$V_{CM} = 0\text{ V to }10\text{ V}$ $V_{CM} = 0.3\text{ V to }9.7\text{ V}; -40^\circ\text{C} \leq T_A \leq +125^\circ\text{C}$ $V_{CM} = 0\text{ V to }10\text{ V}; -40^\circ\text{C} \leq T_A \leq +125^\circ\text{C}$			3 8 12	mV mV mV
Offset Voltage Drift	$\Delta V_{OS}/\Delta T$			3		$\mu\text{V}/^\circ\text{C}$
Input Bias Current	I_B	$-40^\circ\text{C} \leq T_A \leq +125^\circ\text{C}$		2	15	pA
Input Offset Current	I_{OS}	$-40^\circ\text{C} \leq T_A \leq +125^\circ\text{C}$			2.6 30	nA pA
Input Voltage Range	IVR		0		10	V
Common-Mode Rejection Ratio	CMRR	$V_{CM} = 0\text{ V to }10\text{ V}$ $V_{CM} = 0.3\text{ V to }9.7\text{ V}; -40^\circ\text{C} \leq T_A \leq +125^\circ\text{C}$ $V_{CM} = 0\text{ V to }10\text{ V}; -40^\circ\text{C} \leq T_A \leq +125^\circ\text{C}$	70 62 60	88		dB dB dB
Large Signal Voltage Gain	A_{VO}	$R_L = 100\text{ k}\Omega; V_O = 0.5\text{ V to }9.5\text{ V}$ $-40^\circ\text{C} \leq T_A \leq +125^\circ\text{C}$	105 100	120		dB dB
Input Resistance	R_{IN}			10		G Ω
Input Capacitance						
Differential Mode	C_{INDM}			11		pF
Common Mode	C_{INCM}			3.5		pF
OUTPUT CHARACTERISTICS						
Output Voltage High	V_{OH}	$R_L = 100\text{ k}\Omega$ to $V_{CM}; -40^\circ\text{C} \leq T_A \leq +125^\circ\text{C}$	9.98			V
Output Voltage Low	V_{OL}	$R_L = 100\text{ k}\Omega$ to $V_{CM}; -40^\circ\text{C} \leq T_A \leq +125^\circ\text{C}$			20	mV
Short-Circuit Current	I_{SC}			± 11		mA
Closed-Loop Output Impedance	Z_{OUT}	$f = 1\text{ kHz}; A_V = +1$		15		Ω
POWER SUPPLY						
Power Supply Rejection Ratio	PSRR	$V_{SY} = 2.7\text{ V to }18\text{ V}$ $-40^\circ\text{C} \leq T_A \leq +125^\circ\text{C}$	95 90	115		dB dB
Supply Current per Amplifier	I_{SY}	$I_O = 0\text{ mA}$ $-40^\circ\text{C} \leq T_A \leq +125^\circ\text{C}$		18	22 33	μA μA
DYNAMIC PERFORMANCE						
Slew Rate	SR	$R_L = 1\text{ M}\Omega; C_L = 10\text{ pF}; A_V = +1$		75		V/ms
Settling Time to 0.1%	t_s	$V_{IN} = 1\text{ V step}; R_L = 100\text{ k}\Omega; C_L = 10\text{ pF}$		15		μs
Unity-Gain Crossover	UGC	$V_{IN} = 10\text{ mV p-p}; R_L = 1\text{ M}\Omega; C_L = 10\text{ pF}; A_V = +1$		235		kHz
Phase Margin	Φ_M	$V_{IN} = 10\text{ mV p-p}; R_L = 1\text{ M}\Omega; C_L = 10\text{ pF}; A_V = +1$		60		Degrees
Gain Bandwidth Product	GBP	$V_{IN} = 10\text{ mV p-p}; R_L = 1\text{ M}\Omega; C_L = 10\text{ pF}; A_V = +100$		235		kHz
-3 dB Closed-Loop Bandwidth	$f_{-3\text{dB}}$	$V_{IN} = 10\text{ mV p-p}; R_L = 1\text{ M}\Omega; C_L = 10\text{ pF}; A_V = +1$		300		kHz
Channel Separation	CS	$f = 10\text{ kHz}; R_L = 1\text{ M}\Omega$		105		dB
EMI Rejection Ratio of +IN x	EMIRR	$V_{IN} = 100\text{ mV p-p}; f = 400\text{ MHz}, 900\text{ MHz}, 1800\text{ MHz}, 2400\text{ MHz}$		90		dB
NOISE PERFORMANCE						
Voltage Noise	e_n p-p	$f = 0.1\text{ Hz to }10\text{ Hz}$		5		$\mu\text{V p-p}$
Voltage Noise Density	e_n	$f = 1\text{ kHz}$ $f = 10\text{ kHz}$		50 45		nV/ $\sqrt{\text{Hz}}$ nV/ $\sqrt{\text{Hz}}$
Current Noise Density	i_n	$f = 1\text{ kHz}$		0.1		pA/ $\sqrt{\text{Hz}}$

ELECTRICAL CHARACTERISTICS—2.7 V OPERATION

$V_{SY} = 2.7\text{ V}$, $V_{CM} = V_{SY}/2$, $T_A = 25^\circ\text{C}$, unless otherwise noted.

Table 4.

Parameter	Symbol	Test Conditions/Comments	Min	Typ	Max	Unit
INPUT CHARACTERISTICS						
Offset Voltage	V_{OS}	$V_{CM} = 0\text{ V to }2.7\text{ V}$ $V_{CM} = 0.3\text{ V to }2.4\text{ V}; -40^\circ\text{C} \leq T_A \leq +125^\circ\text{C}$ $V_{CM} = 0\text{ V to }2.7\text{ V}; -40^\circ\text{C} \leq T_A \leq +125^\circ\text{C}$			3 4 12	mV mV mV
Offset Voltage Drift	$\Delta V_{OS}/\Delta T$			3		$\mu\text{V}/^\circ\text{C}$
Input Bias Current	I_B	$-40^\circ\text{C} \leq T_A \leq +125^\circ\text{C}$		1	10	pA
Input Offset Current	I_{OS}	$-40^\circ\text{C} \leq T_A \leq +125^\circ\text{C}$			20	pA
Input Voltage Range	IVR		0		2.7	V
Common-Mode Rejection Ratio	CMRR	$V_{CM} = 0\text{ V to }2.7\text{ V}$ $V_{CM} = 0.3\text{ V to }2.4\text{ V}; -40^\circ\text{C} \leq T_A \leq +125^\circ\text{C}$ $V_{CM} = 0\text{ V to }2.7\text{ V}; -40^\circ\text{C} \leq T_A \leq +125^\circ\text{C}$	60	75		dB dB dB
Large Signal Voltage Gain	A_{VO}	$R_L = 100\text{ k}\Omega; V_O = 0.5\text{ V to }2.2\text{ V}$ $-40^\circ\text{C} \leq T_A \leq +125^\circ\text{C}$	97	115		dB
Input Resistance	R_{IN}			10		G Ω
Input Capacitance						
Differential Mode	C_{INDM}			11		pF
Common Mode	C_{INCM}			3.5		pF
OUTPUT CHARACTERISTICS						
Output Voltage High	V_{OH}	$R_L = 100\text{ k}\Omega$ to V_{CM} ; $-40^\circ\text{C} \leq T_A \leq +125^\circ\text{C}$	2.69			V
Output Voltage Low	V_{OL}	$R_L = 100\text{ k}\Omega$ to V_{CM} ; $-40^\circ\text{C} \leq T_A \leq +125^\circ\text{C}$			10	mV
Short-Circuit Current	I_{SC}			± 4		mA
Closed-Loop Output Impedance	Z_{OUT}	$f = 1\text{ kHz}; A_V = +1$		20		Ω
POWER SUPPLY						
Power Supply Rejection Ratio	PSRR	$V_{SY} = 2.7\text{ V to }18\text{ V}$ $-40^\circ\text{C} \leq T_A \leq +125^\circ\text{C}$	95 90	115		dB dB
Supply Current per Amplifier	I_{SY}	$I_O = 0\text{ mA}$ $-40^\circ\text{C} \leq T_A \leq +125^\circ\text{C}$		18	22 33	μA μA
DYNAMIC PERFORMANCE						
Slew Rate	SR	$R_L = 1\text{ M}\Omega; C_L = 10\text{ pF}; A_V = +1$		50		V/ms
Settling Time to 0.1%	t_s	$V_{IN} = 1\text{ V step}; R_L = 100\text{ k}\Omega; C_L = 10\text{ pF}$		20		μs
Unity Gain Crossover	UGC	$V_{IN} = 10\text{ mV p-p}; R_L = 1\text{ M}\Omega; C_L = 10\text{ pF}; A_V = +1$		190		kHz
Phase Margin	Φ_M	$V_{IN} = 10\text{ mV p-p}; R_L = 1\text{ M}\Omega; C_L = 10\text{ pF}; A_V = +1$		60		Degrees
Gain Bandwidth Product	GBP	$V_{IN} = 10\text{ mV p-p}; R_L = 1\text{ M}\Omega; C_L = 10\text{ pF}; A_V = +100$		200		kHz
–3 dB Closed-Loop Bandwidth	$f_{-3\text{ dB}}$	$V_{IN} = 10\text{ mV p-p}; R_L = 1\text{ M}\Omega; C_L = 10\text{ pF}; A_V = +1$		250		kHz
Channel Separation	CS	$f = 10\text{ kHz}; R_L = 1\text{ M}\Omega$		105		dB
EMI Rejection Ratio of +IN x	EMIRR	$V_{IN} = 100\text{ mV p-p}; f = 400\text{ MHz}, 900\text{ MHz}, 1800\text{ MHz}, 2400\text{ MHz}$		90		dB
NOISE PERFORMANCE						
Voltage Noise	e_n p-p	$f = 0.1\text{ Hz to }10\text{ Hz}$		6		$\mu\text{V p-p}$
Voltage Noise Density	e_n	$f = 1\text{ kHz}$ $f = 10\text{ kHz}$		60 56		$\text{nV}/\sqrt{\text{Hz}}$ $\text{nV}/\sqrt{\text{Hz}}$
Current Noise Density	i_n	$f = 1\text{ kHz}$		0.1		$\text{pA}/\sqrt{\text{Hz}}$

ABSOLUTE MAXIMUM RATINGS

Table 5.

Parameter	Rating
Supply Voltage	20.5 V
Input Voltage	(V ₋) – 300 mV to (V ₊) + 300 mV
Input Current ¹	±10 mA
Differential Input Voltage	±V _{SY}
Output Short-Circuit Duration to GND	Indefinite
Storage Temperature Range	–65°C to +150°C
Operating Temperature Range	–40°C to +125°C
Junction Temperature Range	–65°C to +150°C
Lead Temperature (Soldering, 60 sec)	300°C

¹ The input pins have clamp diodes to the power supply pins. Limit the input current to 10 mA or less whenever input signals exceed the power supply rail by 0.3 V.

Stresses above those listed under Absolute Maximum Ratings may cause permanent damage to the device. This is a stress rating only; functional operation of the device at these or any other conditions above those indicated in the operational section of this specification is not implied. Exposure to absolute maximum rating conditions for extended periods may affect device reliability.

THERMAL RESISTANCE

θ_{JA} is specified for the worst-case conditions, that is, a device soldered in a circuit board for surface-mount packages using a standard 4-layer board.

Table 6. Thermal Resistance

Package Type	θ_{JA}	θ_{JC}	Unit
8-Lead MSOP (RM-8)	142	45	°C/W
14-Lead SOIC_N (R-14)	115	36	°C/W

ESD CAUTION



ESD (electrostatic discharge) sensitive device. Charged devices and circuit boards can discharge without detection. Although this product features patented or proprietary protection circuitry, damage may occur on devices subjected to high energy ESD. Therefore, proper ESD precautions should be taken to avoid performance degradation or loss of functionality.

TYPICAL PERFORMANCE CHARACTERISTICS

$T_A = 25^\circ\text{C}$, unless otherwise noted.

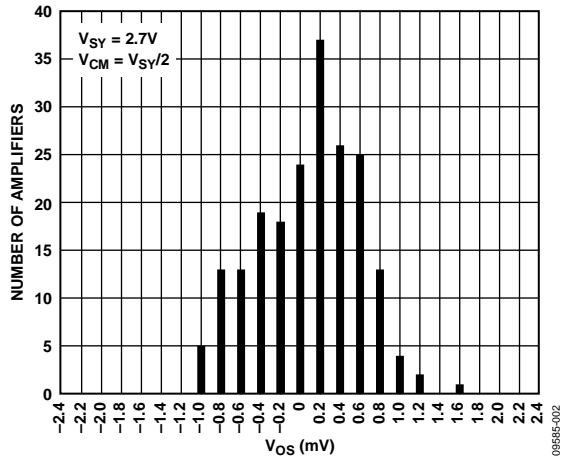

Figure 3. Input Offset Voltage Distribution

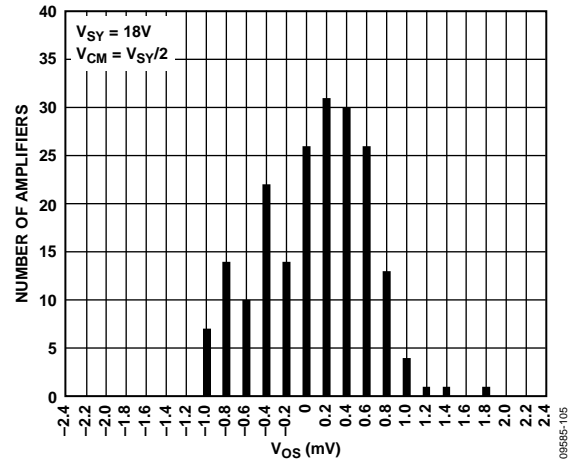

Figure 6. Input Offset Voltage Distribution

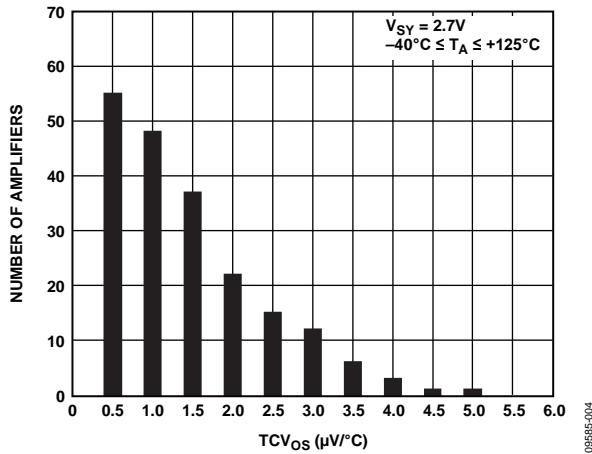

Figure 4. Input Offset Voltage Drift Distribution

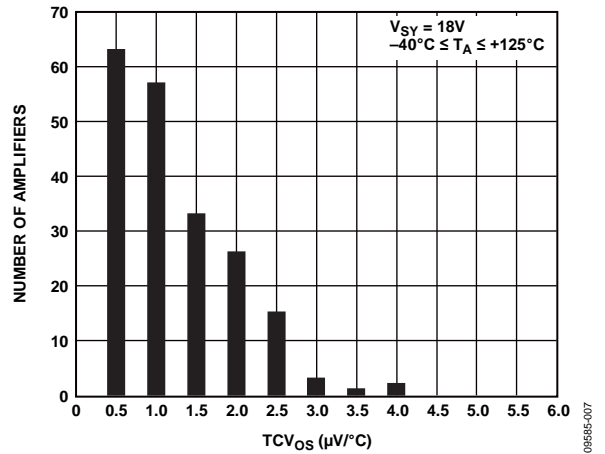

Figure 7. Input Offset Voltage Drift Distribution



Figure 5. Input Offset Voltage vs. Common-Mode Voltage

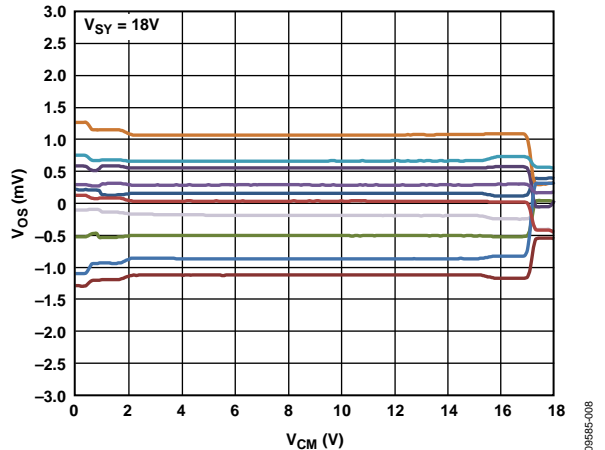

Figure 8. Input Offset Voltage vs. Common-Mode Voltage



Figure 9. Input Offset Voltage vs. Common-Mode Voltage



Figure 12. Input Offset Voltage vs. Common-Mode Voltage



Figure 10. Input Bias Current vs. Temperature



Figure 13. Input Bias Current vs. Temperature

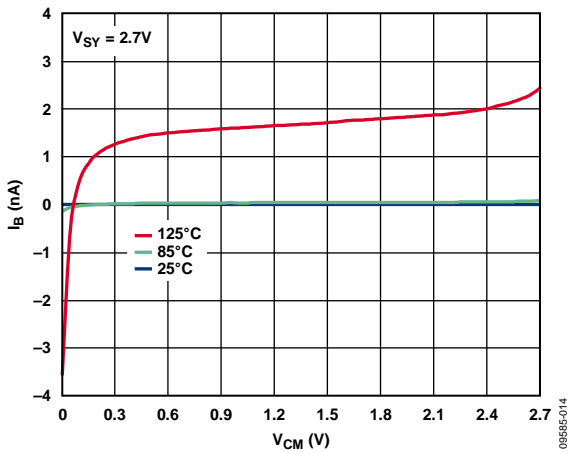

Figure 11. Input Bias Current vs. Common-Mode Voltage

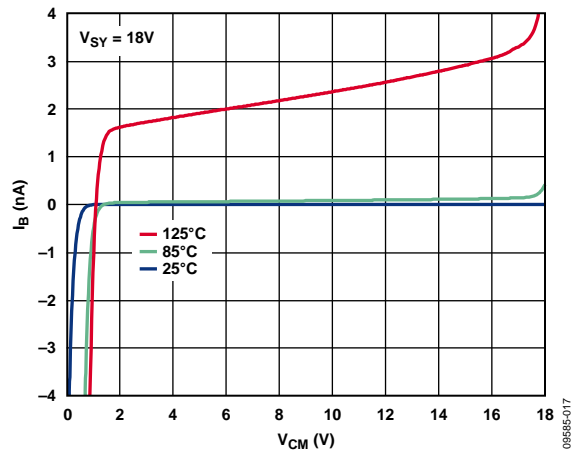

Figure 14. Input Bias Current vs. Common-Mode Voltage



Figure 15. Output Voltage (V_{OH}) to Supply Rail vs. Load Current

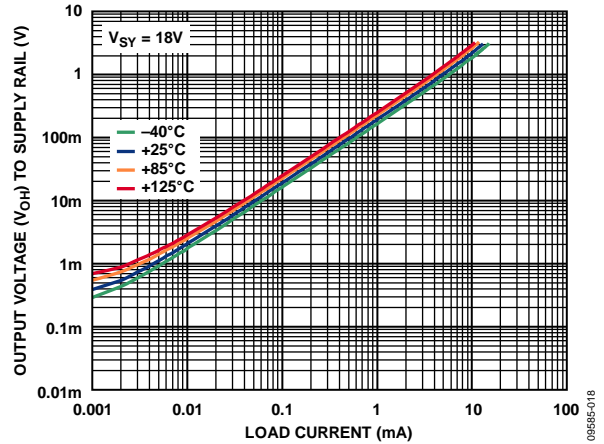

Figure 18. Output Voltage (V_{OH}) to Supply Rail vs. Load Current

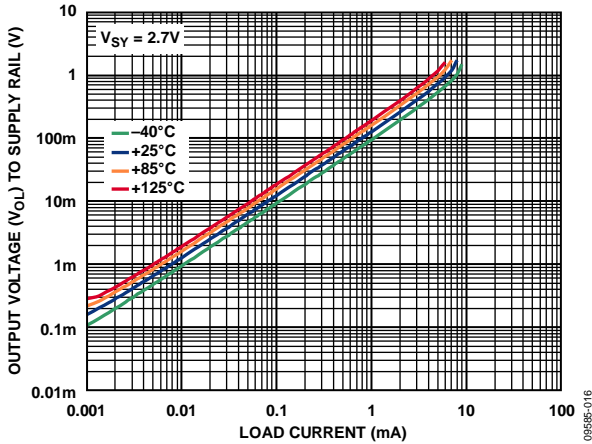

Figure 16. Output Voltage (V_{OI}) to Supply Rail vs. Load Current

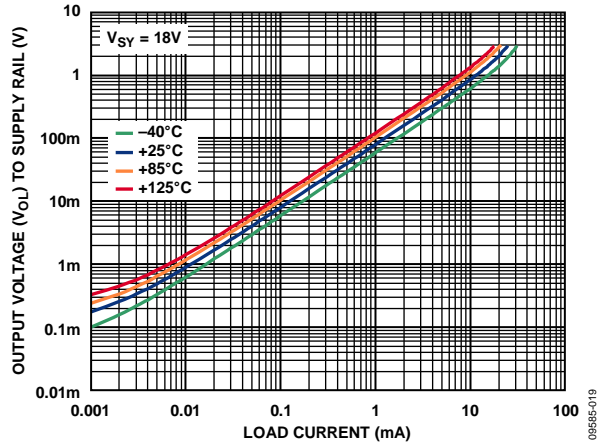

Figure 19. Output Voltage (V_{OI}) to Supply Rail vs. Load Current



Figure 17. Output Voltage (V_{OH}) vs. Temperature

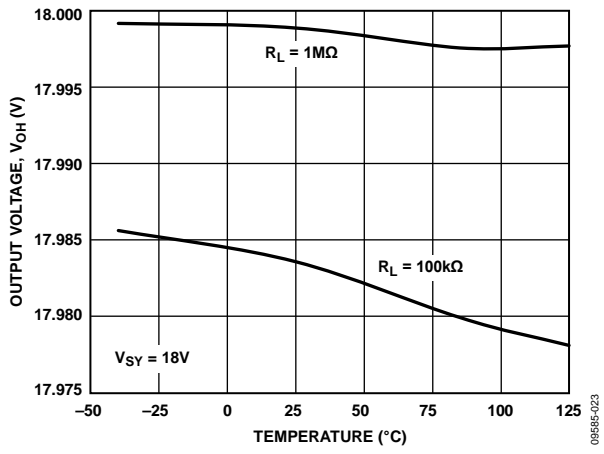

Figure 20. Output Voltage (V_{OH}) vs. Temperature



Figure 21. Output Voltage (V_{O}) vs. Temperature

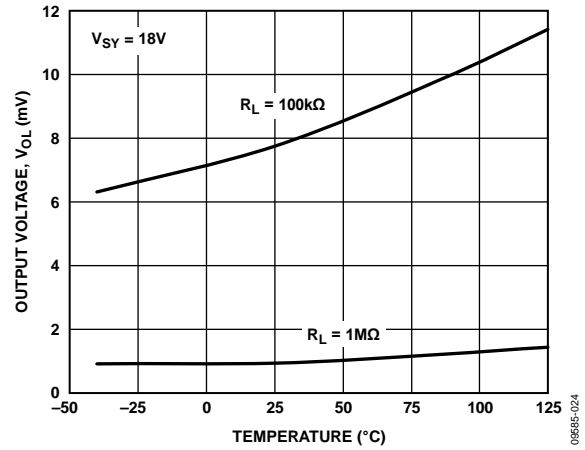

Figure 24. Output Voltage (V_{O}) vs. Temperature

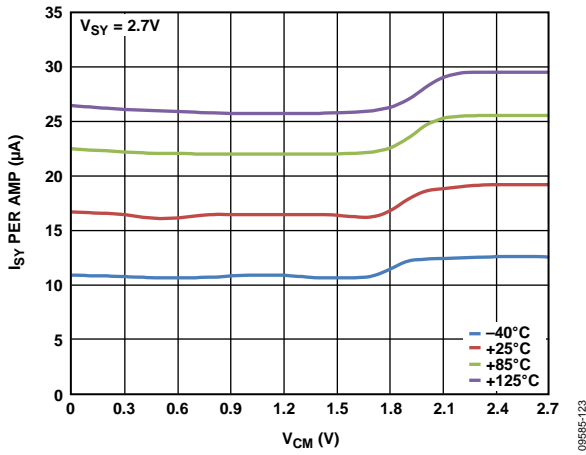

Figure 22. Supply Current per Amplifier vs. Common-Mode Voltage

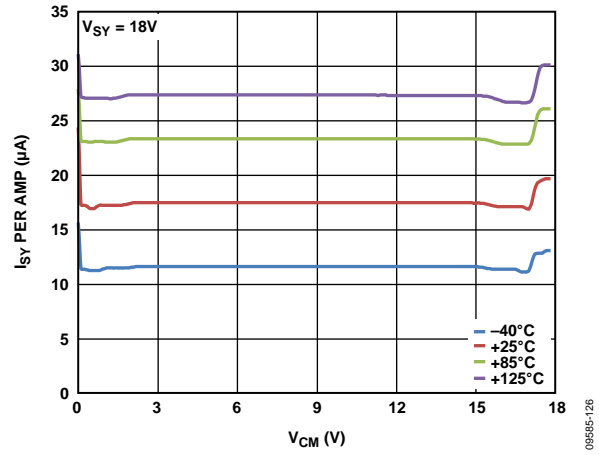

Figure 25. Supply Current per Amplifier vs. Common-Mode Voltage

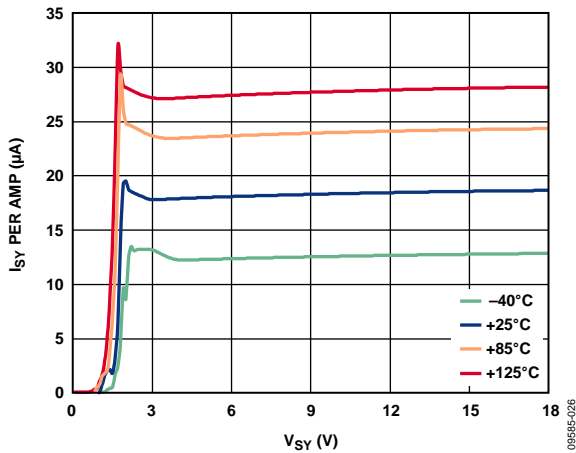

Figure 23. Supply Current per Amplifier vs. Supply Voltage

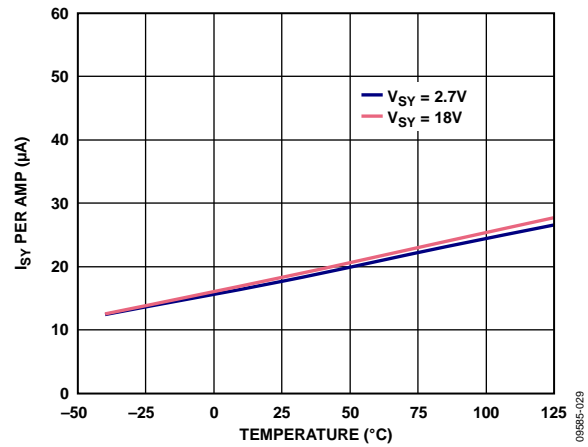

Figure 26. Supply Current per Amplifier vs. Temperature

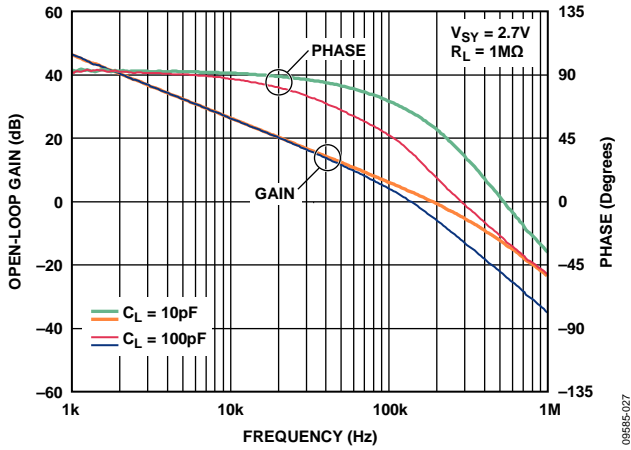

Figure 27. Open-Loop Gain and Phase vs. Frequency

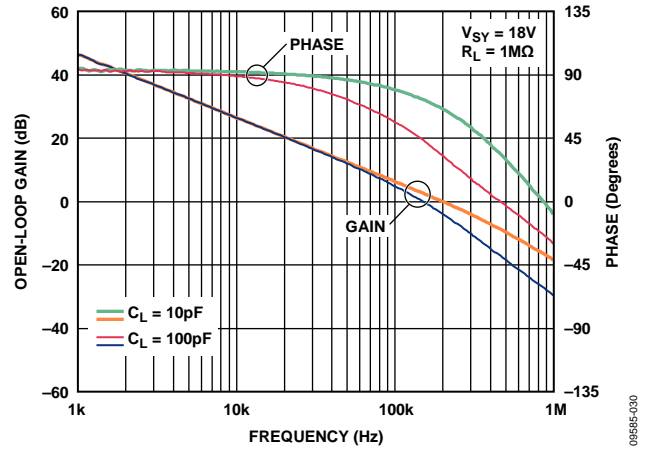

Figure 30. Open-Loop Gain and Phase vs. Frequency

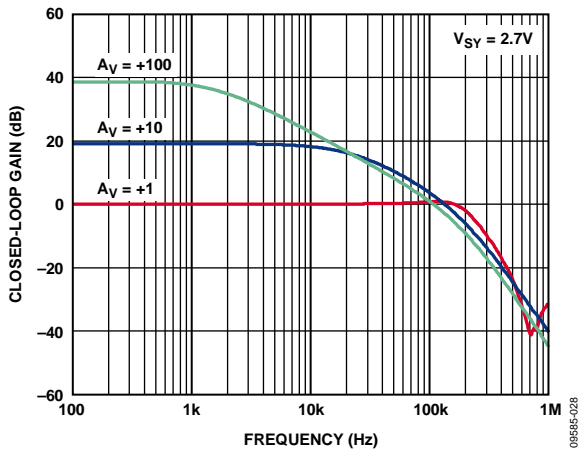

Figure 28. Closed-Loop Gain vs. Frequency

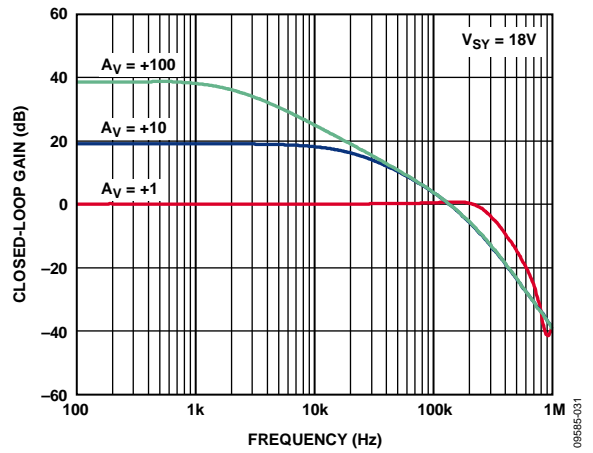

Figure 31. Closed-Loop Gain vs. Frequency

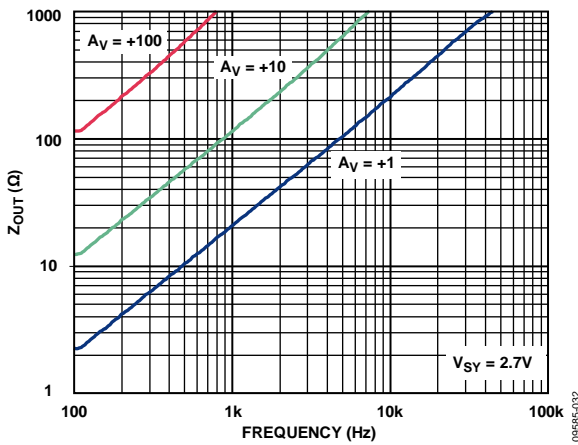

Figure 29. Output Impedance vs. Frequency

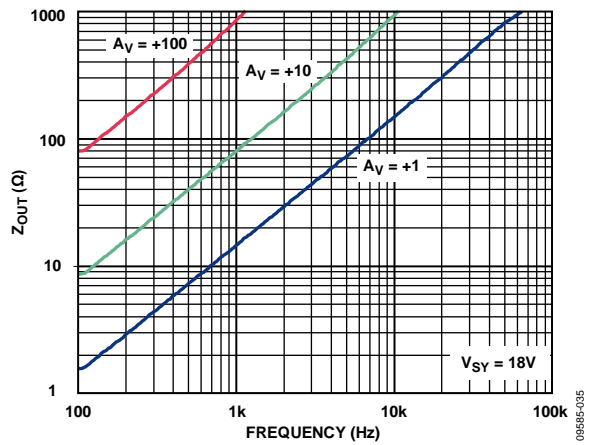

Figure 32. Output Impedance vs. Frequency



Figure 33. CMRR vs. Frequency

09585-134

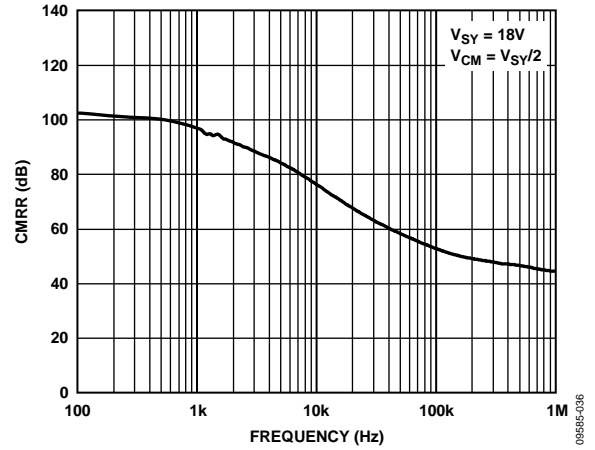

Figure 36. CMRR vs. Frequency

09585-036

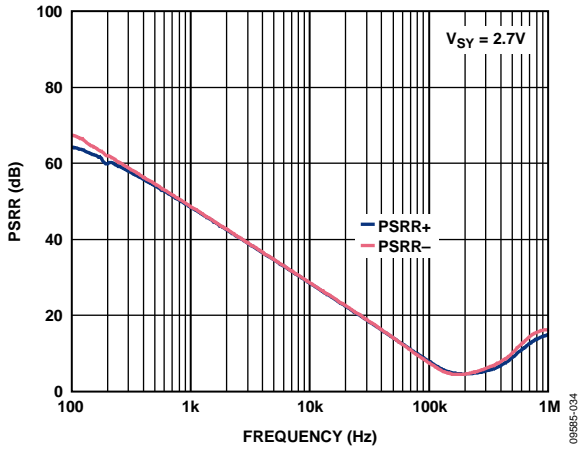

Figure 34. PSRR vs. Frequency

09585-034

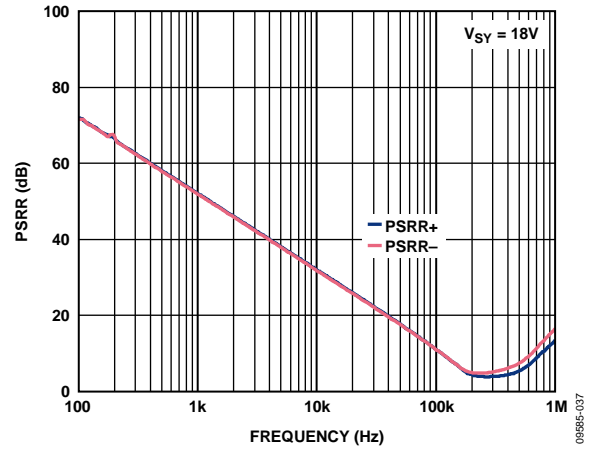

Figure 37. PSRR vs. Frequency

09585-037

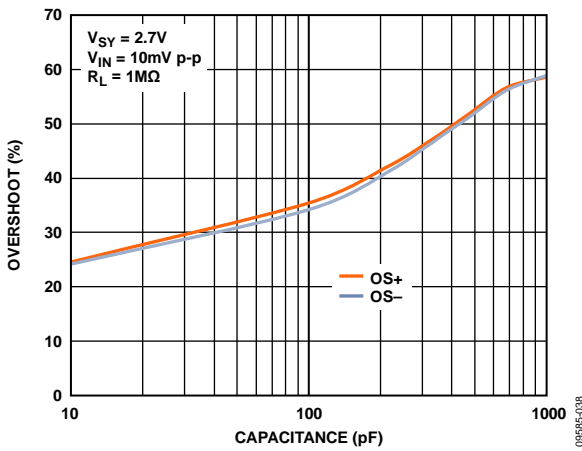

Figure 35. Small Signal Overshoot vs. Load Capacitance

09585-038

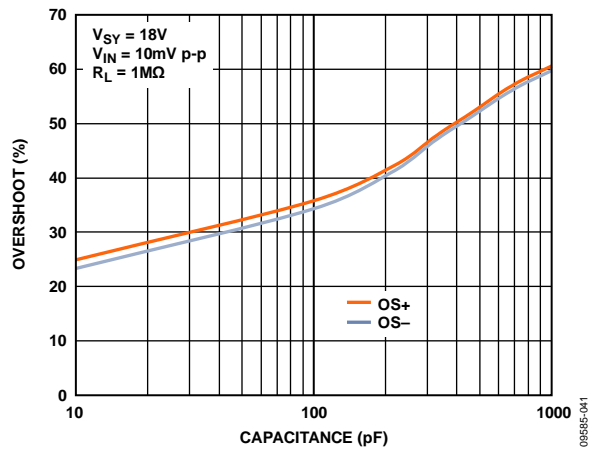

Figure 38. Small Signal Overshoot vs. Load Capacitance

09585-041

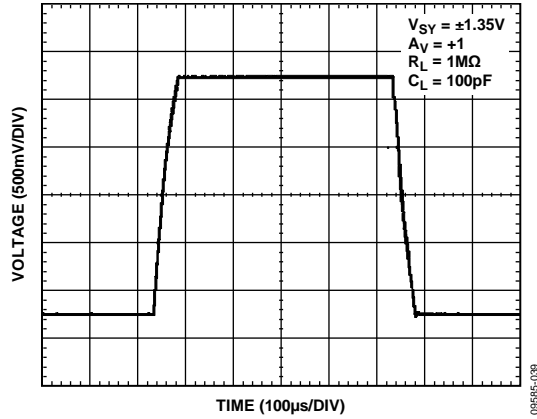

Figure 39. Large Signal Transient Response

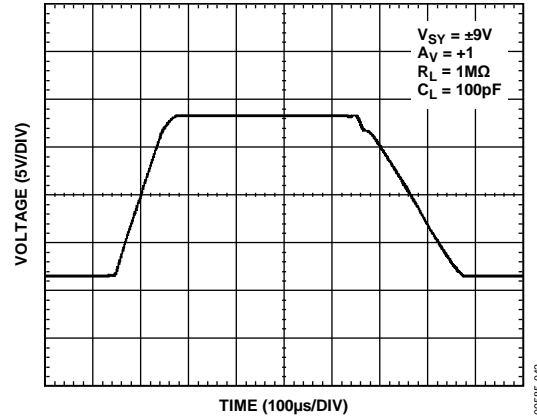

Figure 42. Large Signal Transient Response

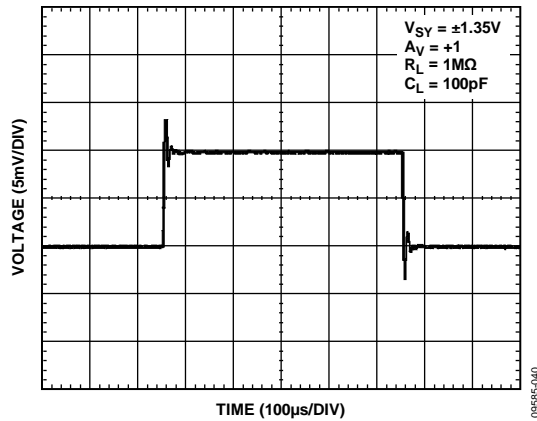

Figure 40. Small Signal Transient Response

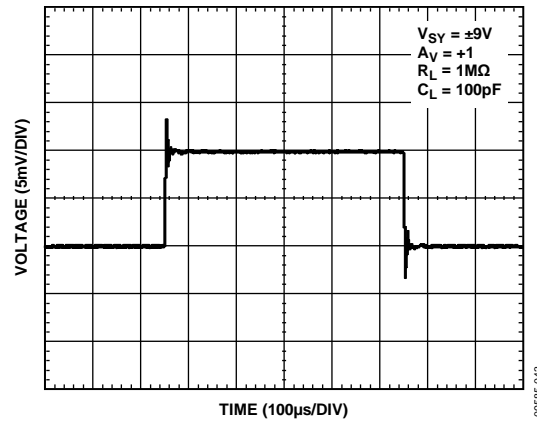

Figure 43. Small Signal Transient Response

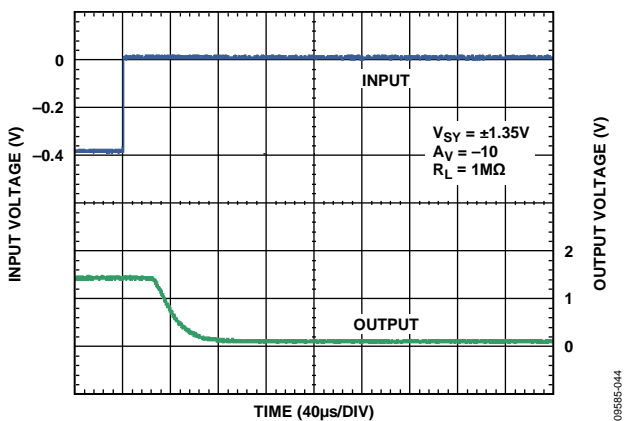

Figure 41. Positive Overload Recovery

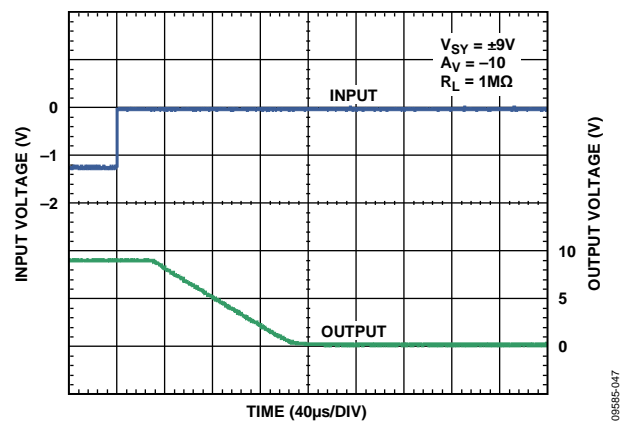

Figure 44. Positive Overload Recovery

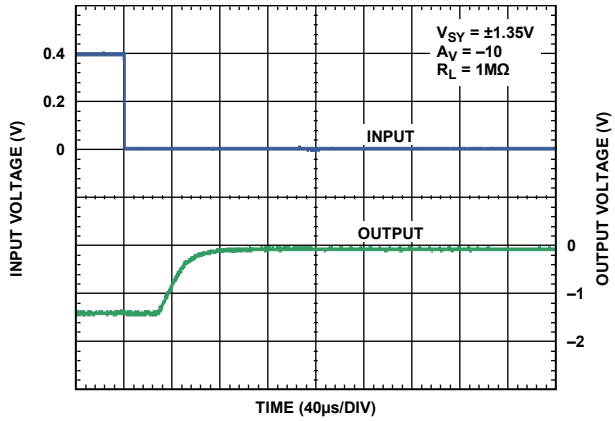

Figure 45. Negative Overload Recovery

09585-045

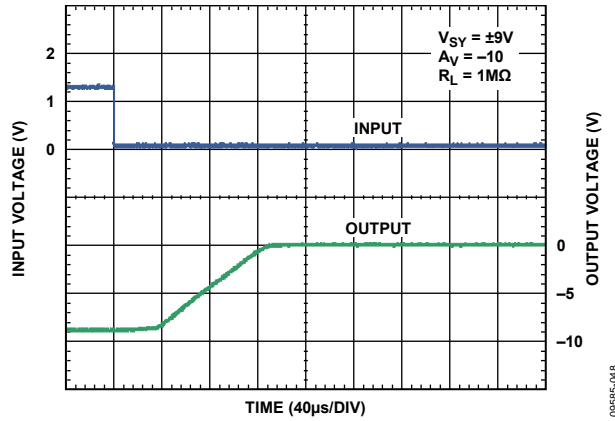

Figure 48. Negative Overload Recovery

09585-048

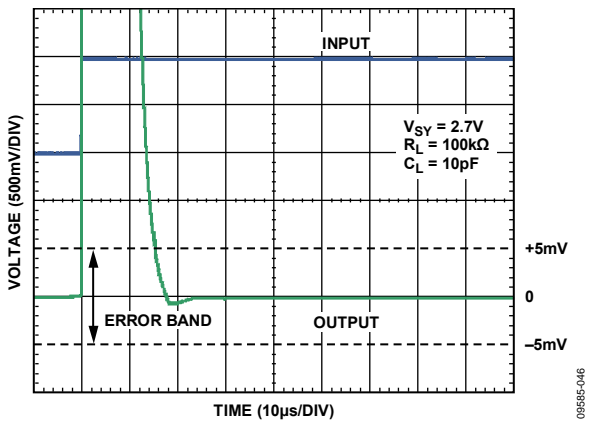

Figure 46. Positive Settling Time to 0.1%

09585-046

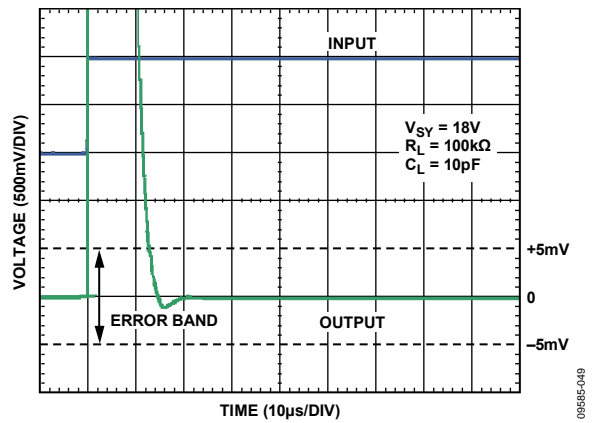

Figure 49. Positive Settling Time to 0.1%

09585-049

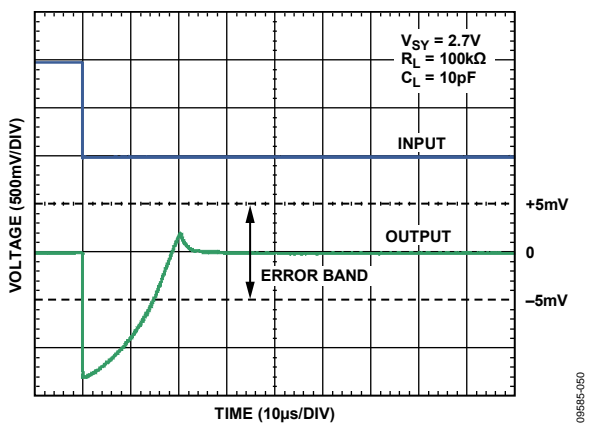

Figure 47. Negative Settling Time to 0.1%

09585-050

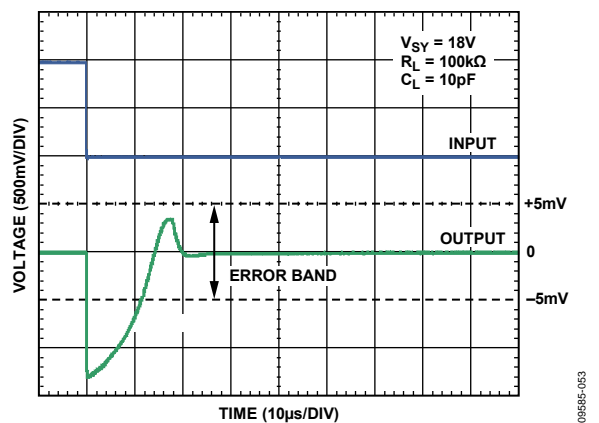

Figure 50. Negative Settling Time to 0.1%

09585-053

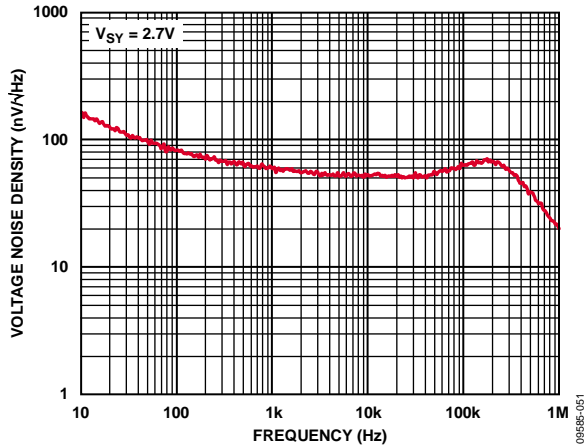

Figure 51. Voltage Noise Density vs. Frequency

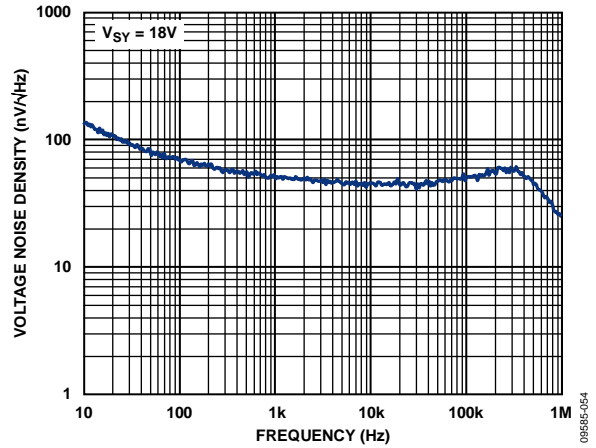

Figure 54. Voltage Noise Density vs. Frequency

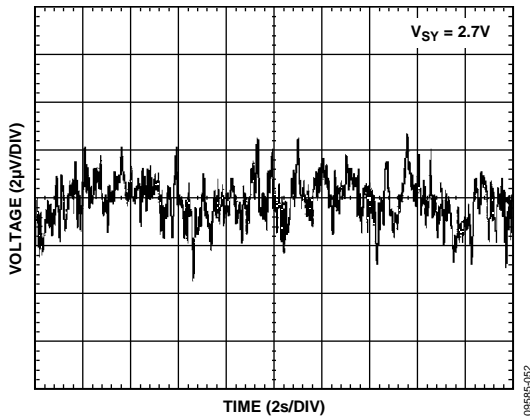

Figure 52. 0.1 Hz to 10 Hz Noise

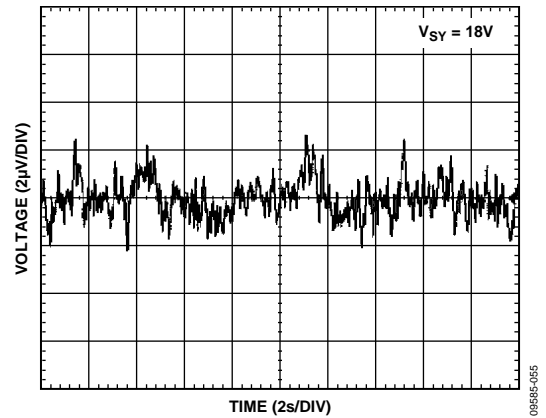

Figure 55. 0.1 Hz to 10 Hz Noise

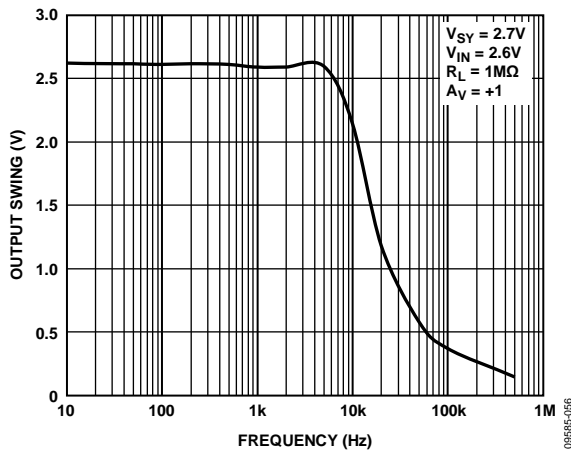

Figure 53. Output Swing vs. Frequency

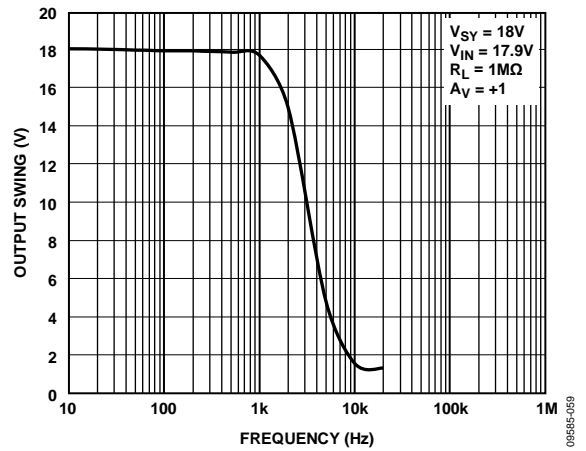

Figure 56. Output Swing vs. Frequency



Figure 57. THD + N vs. Frequency

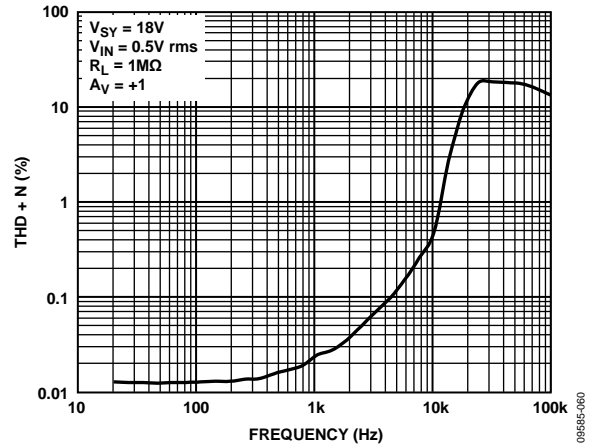

Figure 59. THD + N vs. Frequency

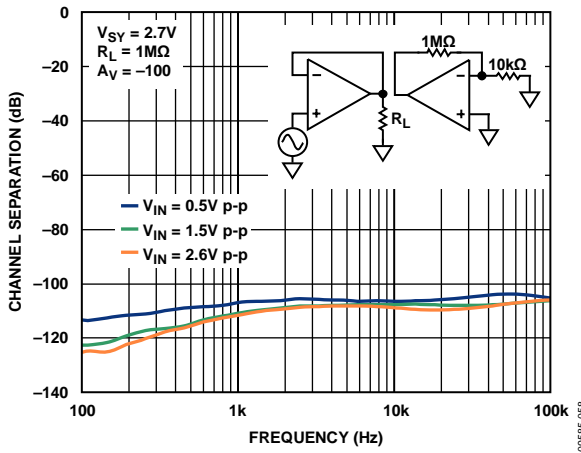

Figure 58. Channel Separation vs. Frequency

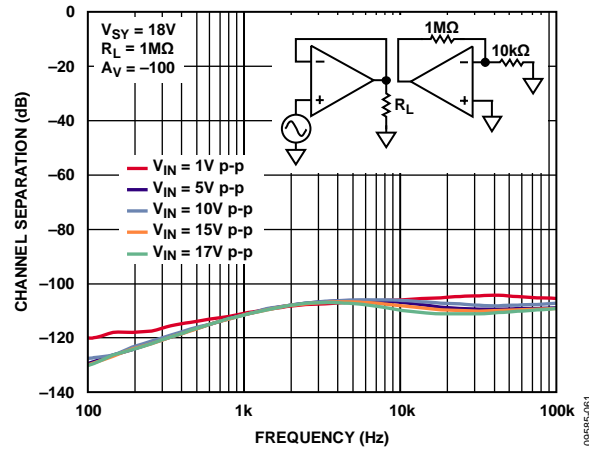

Figure 60. Channel Separation vs. Frequency

APPLICATIONS INFORMATION

The AD8546/AD8548 are low input bias current, micropower CMOS amplifiers that operate over a wide supply voltage range of 2.7 V to 18 V. The AD8546/AD8548 also employ unique input and output stages to achieve rail-to-rail input and output ranges with very low supply current.

INPUT STAGE

Figure 61 shows the simplified schematic of the AD8546/AD8548. The input stage comprises two differential transistor pairs: an NMOS pair (M1, M2) and a PMOS pair (M3, M4). The input common-mode voltage determines which differential pair turns on and is more active than the other.

The PMOS differential pair is active when the input voltage approaches and reaches the lower supply rail. The NMOS differential pair is needed for input voltages up to and including the upper supply rail. This topology allows the amplifier to maintain a wide dynamic input voltage range and maximize signal swing to both supply rails. For the greater part of the input common-mode voltage range, the PMOS differential pair is active.

Differential pairs commonly exhibit different offset voltages. The handoff from one pair to the other creates a step-like characteristic that is visible in the V_{OS} vs. V_{CM} graphs (see Figure 5 and Figure 8). This characteristic is inherent in all rail-to-rail amplifiers that use the dual differential pair topology. Therefore, always choose a common-mode voltage that does not include the region of handoff from one input differential pair to the other.

Additional steps in the V_{OS} vs. V_{CM} graphs are also visible as the input common-mode voltage approaches the power supply rails. These changes are a result of the load transistors (M8, M9, M14, and M15) running out of headroom. As the load transistors are forced into the triode region of operation, the mismatch of their

drain impedances contributes to the offset voltage of the amplifier. This problem is exacerbated at high temperatures due to the decrease in the threshold voltage of the input transistors. See Figure 9 and Figure 12 for typical performance data.

Current Source I1 drives the PMOS transistor pair. As the input common-mode voltage approaches the upper rail, I1 is steered away from the PMOS differential pair through the M5 transistor. The bias voltage, VB1, controls the point where this transfer occurs.

M5 diverts the tail current into a current mirror consisting of the M6 and M7 transistors. The output of the current mirror then drives the NMOS transistor pair. Note that the activation of this current mirror causes a slight increase in supply current at high common-mode voltages (see Figure 22 and Figure 25).

The AD8546/AD8548 achieve their high performance by using low voltage MOS devices for their differential inputs. These low voltage MOS devices offer excellent noise and bandwidth per unit of current. Each differential input pair is protected by proprietary regulation circuitry (not shown in Figure 61). The regulation circuitry consists of a combination of active devices, which maintain the proper voltages across the input pairs during normal operation, and passive clamping devices, which protect the amplifier during fast transients. However, these passive clamping devices begin to forward-bias as the common-mode voltage approaches either power supply rail. This causes an increase in the input bias current (see Figure 11 and Figure 14).

The input devices are also protected from large differential input voltages by clamp diodes (D1 and D2). These diodes are buffered from the inputs with two 10 k Ω resistors (R1 and R2). The differential diodes turn on when the differential input voltage exceeds approximately 600 mV; in this condition, the differential input resistance drops to 20 k Ω .

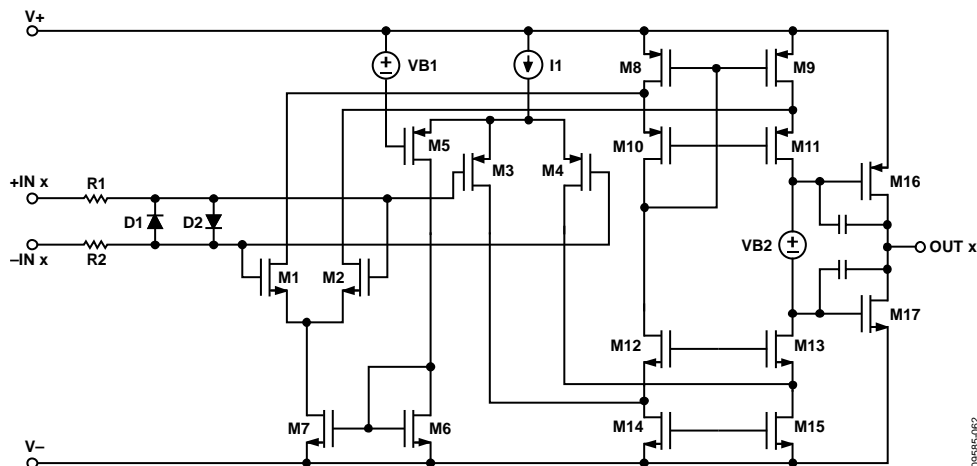

Figure 61. Simplified Schematic

09585-082

OUTPUT STAGE

The AD8546/AD8548 feature a complementary output stage consisting of the M16 and M17 transistors (see Figure 61). These transistors are configured in a Class AB topology and are biased by the voltage source, VB2. This topology allows the output voltage to go within millivolts of the supply rails, achieving a rail-to-rail output swing. The output voltage is limited by the output impedance of the transistors, which are low R_{ON} MOS devices. The output voltage swing is a function of the load current and can be estimated using the output voltage to supply rail vs. load current graphs (see Figure 15, Figure 16, Figure 18, and Figure 19).

RAIL-TO-RAIL INPUT AND OUTPUT

The AD8546/AD8548 feature rail-to-rail input and output with a supply voltage from 2.7 V to 18 V. Figure 62 shows the input and output waveforms of the AD8546/AD8548 configured as a unity-gain buffer with a supply voltage of ± 9 V and a resistive load of 1 M Ω . With an input voltage of ± 9 V, the AD8546/AD8548 allow the output to swing very close to both rails. Additionally, the AD8546/AD8548 do not exhibit phase reversal.

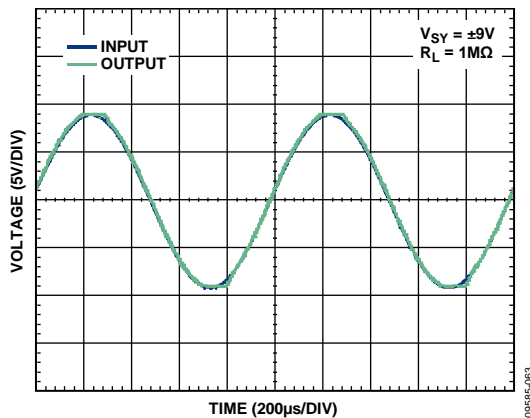

Figure 62. Rail-to-Rail Input and Output

RESISTIVE LOAD

The feedback resistor alters the load resistance that an amplifier sees. Therefore, it is important to carefully select the value of the feedback resistors used with the AD8546/AD8548. The amplifiers are capable of driving resistive loads down to 100 k Ω . The Inverting Op Amp Configuration section and the Noninverting Op Amp Configuration section show how the feedback resistor changes the actual load resistance seen at the output of the amplifier.

Inverting Op Amp Configuration

Figure 63 shows the AD8546/AD8548 in an inverting configuration with a resistive load, R_L , at the output. The actual load seen by the amplifier is the parallel combination of the feedback resistor, R_2 , and the load, R_L . For example, the combination of a feedback resistor of 1 k Ω and a load of 1 M Ω results in an equivalent load resistance of 999 Ω at the output. Because the AD8546/AD8548 are incapable of driving such a heavy load, performance degrades greatly.

To avoid loading the output, use a larger feedback resistor, but consider the effect of resistor thermal noise on the overall circuit.

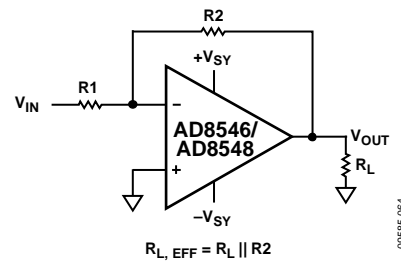

Figure 63. Inverting Op Amp Configuration

Noninverting Op Amp Configuration

Figure 64 shows the AD8546/AD8548 in a noninverting configuration with a resistive load, R_L , at the output. The actual load seen by the amplifier is the parallel combination of $R_1 + R_2$ and R_L .

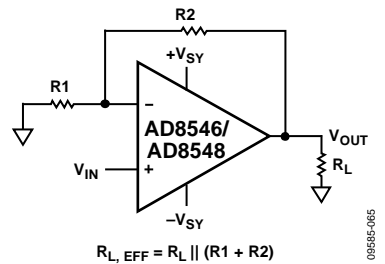

Figure 64. Noninverting Op Amp Configuration

COMPARATOR OPERATION

An op amp is designed to operate in a closed-loop configuration with feedback from its output to its inverting input. Figure 65 shows the AD8546 configured as a voltage follower with an input voltage that is always kept at the midpoint of the power supplies. The same configuration is applied to the unused channel. A1 and A2 indicate the placement of ammeters to measure supply current. I_{SY+} refers to the current flowing from the upper supply rail to the op amp, and I_{SY-} refers to the current flowing from the op amp to the lower supply rail.

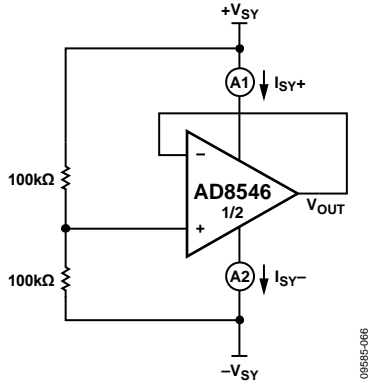

Figure 65. Voltage Follower Configuration

As expected, Figure 66 shows that in normal operating condition, the total current flowing into the op amp is equivalent to the total current flowing out of the op amp, where $I_{SY+} = I_{SY-} = 36 \mu A$ at the AD8546 at $V_{SY} = 18 V$.

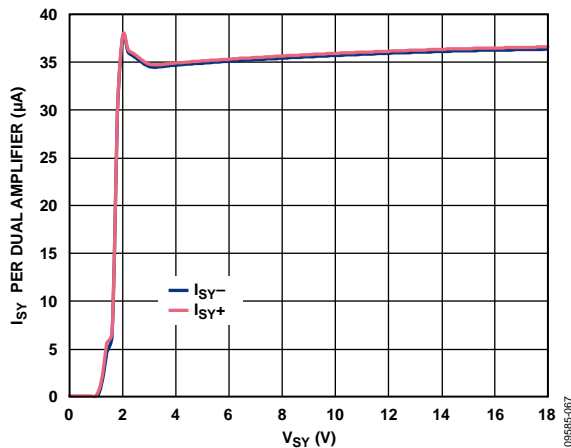

Figure 66. Supply Current vs. Supply Voltage (Voltage Follower)

In contrast to op amps, comparators are designed to work in an open-loop configuration and to drive logic circuits. Although op amps are different from comparators, occasionally an unused section of a dual or quad op amp is used as a comparator to save board space and cost; however, this is not recommended.

Figure 67 and Figure 68 show the AD8546 configured as a comparator, with 100 kΩ resistors in series with the input pins. The unused channel is configured as a buffer with the input voltage kept at the midpoint of the power supplies.

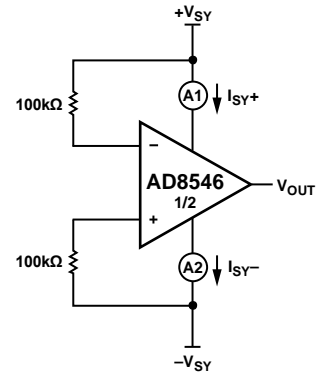

Figure 67. Comparator Configuration A

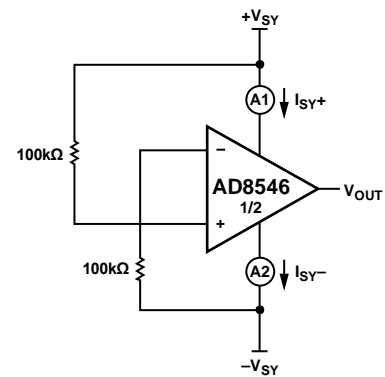

Figure 68. Comparator Configuration B

The AD8546/AD8548 have input devices that are protected from large differential input voltages by Diode D1 and Diode D2 (see Figure 61). These diodes consist of substrate PNP bipolar transistors and turn on when the differential input voltage exceeds approximately 600 mV; however, these diodes also allow a current path from the input to the lower supply rail, resulting in an increase in the total supply current of the system. As shown in Figure 69, both configurations yield the same result. At 18 V of power supply, I_{SY+} remains at 36 μA per dual amplifier, but I_{SY-} increases to 140 μA in magnitude per dual amplifier.

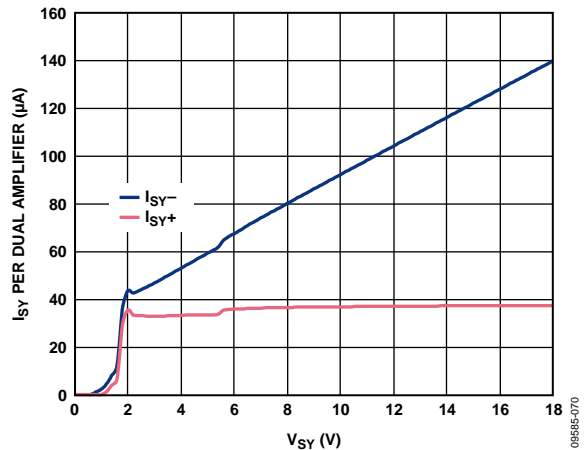

Figure 69. Supply Current vs. Supply Voltage (AD8546 as a Comparator)

Note that 100 kΩ resistors are used in series with the input of the op amp. If smaller resistor values are used, the supply current of the system increases much more. For more information about using op amps as comparators, see the [AN-849 Application Note, Using Op Amps as Comparators](#).

EMI REJECTION RATIO

Circuit performance is often adversely affected by high frequency electromagnetic interference (EMI). In the event where signal strength is low and transmission lines are long, an op amp must accurately amplify the input signals. However, all op amp pins—the noninverting input, inverting input, positive supply, negative supply, and output pins—are susceptible to EMI signals. These high frequency signals are coupled into an op amp by various means such as conduction, near field radiation, or far field radiation. For instance, wires and PCB traces can act as antennas and pick up high frequency EMI signals.

Op amps, such as the [AD8546](#) and [AD8548](#), do not amplify EMI or RF signals because of their relatively low bandwidth. However, due to the nonlinearities of the input devices, op amps can rectify these out-of-band signals. When these high frequency signals are rectified, they appear as a dc offset at the output.

To describe the ability of the [AD8546/AD8548](#) to perform as intended in the presence of an electromagnetic energy, the electromagnetic interference rejection ratio (EMIRR) of the noninverting pin is specified in Table 2, Table 3, and Table 4 of the Specifications section. A mathematical method of measuring EMIRR is defined as follows:

$$EMIRR = 20 \log (V_{IN_PEAK} / \Delta V_{OS})$$

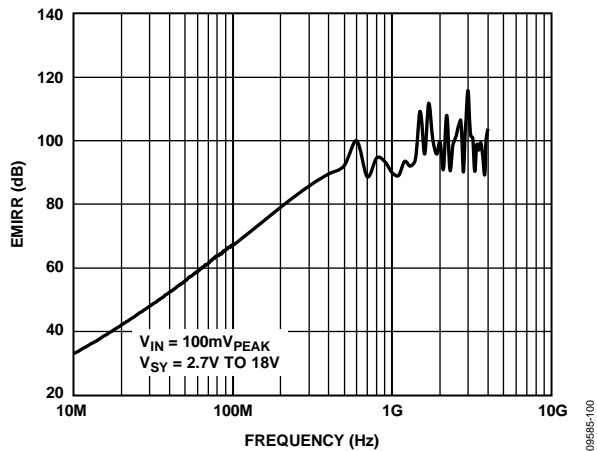
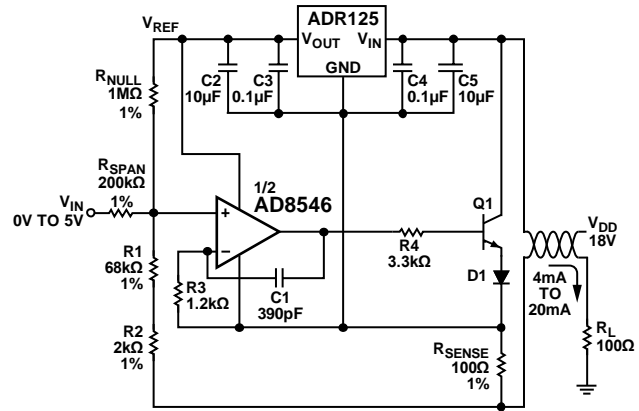

Figure 70. EMIRR vs. Frequency

4 mA TO 20 mA PROCESS CONTROL CURRENT LOOP TRANSMITTER

A 2-wire current transmitter is often used in distributed control systems and process control applications to transmit analog signals between sensors and process controllers. Figure 71 shows a 4 mA to 20 mA current loop transmitter.



NOTES
1. $R_1 + R_2 = R'$.

Figure 71. 4 mA to 20 mA Current Loop Transmitter

The transmitter is powered directly from the control loop power supply, and the current in the loop carries signal from 4 mA to 20 mA. Thus, 4 mA establishes the baseline current budget within which the circuit must operate.

The [AD8546](#) is an excellent choice due to its low supply current of 33 μA per amplifier over temperature and supply voltage. The current transmitter controls the current flowing in the loop, where a zero-scale input signal is represented by 4 mA of current and a full-scale input signal is represented by 20 mA. The transmitter also floats from the control loop power supply, V_{DD} , whereas signal ground is in the receiver. The loop current is measured at the load resistor, R_L , at the receiver side.

With a zero-scale input, a current of V_{REF}/R_{NULL} flows through R' . This creates a current, I_{SENSE} , that flows through the sense resistor, as determined by the following equation:

$$I_{SENSE, MIN} = (V_{REF} \times R') / (R_{NULL} \times R_{SENSE})$$

With a full-scale input voltage, current flowing through R' is increased by the full-scale change in V_{IN}/R_{SPAN} . This creates an increase in the current flowing through the sense resistor.

$$I_{SENSE, DELTA} = (Full\text{-Scale Change in } V_{IN} \times R') / (R_{SPAN} \times R_{SENSE})$$

Therefore,

$$I_{SENSE, MAX} = I_{SENSE, MIN} + I_{SENSE, DELTA}$$

When $R' \gg R_{SENSE}$, the current through the load resistor at the receiver side is almost equivalent to I_{SENSE} .

Figure 71 shows a design for a full-scale input voltage of 5 V. At 0 V of input, the loop current is 3.5 mA, and at a full-scale input of 5 V, the loop current is 21 mA. This allows software calibration to fine-tune the current loop to the 4 mA to 20 mA range.

Together, the [AD8546](#) and the [ADR125](#) consume quiescent current of only 160 μA, making 3.34 mA current available to power additional signal conditioning circuitry or to power a bridge circuit.

OUTLINE DIMENSIONS

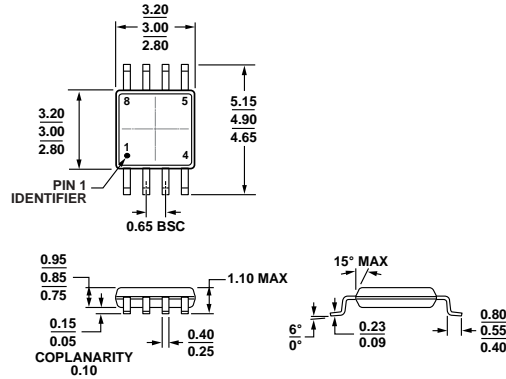

COMPLIANT TO JEDEC STANDARDS MO-187-AA

Figure 72. 8-Lead Mini Small Outline Package [MSOP] (RM-8)

Dimensions shown in millimeters

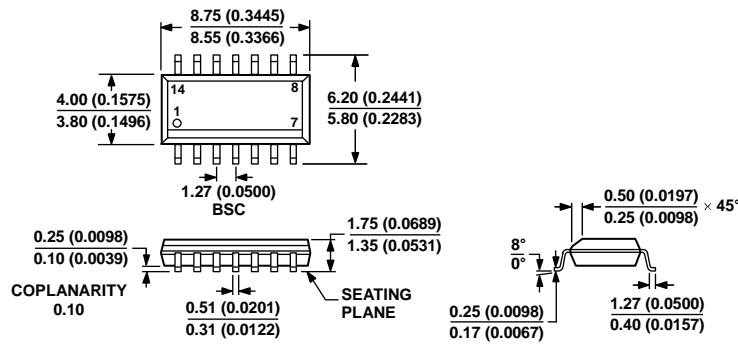

COMPLIANT TO JEDEC STANDARDS MS-012-AB

CONTROLLING DIMENSIONS ARE IN MILLIMETERS; INCH DIMENSIONS (IN PARENTHESES) ARE ROUNDED-OFF MILLIMETER EQUIVALENTS FOR REFERENCE ONLY AND ARE NOT APPROPRIATE FOR USE IN DESIGN.

Figure 73. 14-Lead Standard Small Outline Package [SOIC_N] Narrow Body (R-14)

Dimensions shown in millimeters and (inches)

ORDERING GUIDE

Model ¹	Temperature Range	Package Description	Package Option	Branding
AD8546ARMZ	-40°C to +125°C	8-Lead Mini Small Outline Package [MSOP]	RM-8	A2V
AD8546ARMZ-RL	-40°C to +125°C	8-Lead Mini Small Outline Package [MSOP]	RM-8	A2V
AD8546ARMZ-R7	-40°C to +125°C	8-Lead Mini Small Outline Package [MSOP]	RM-8	A2V
AD8548ARZ	-40°C to +125°C	14-Lead Standard Small Outline Package [SOIC_N]	R-14	
AD8548ARZ-RL	-40°C to +125°C	14-Lead Standard Small Outline Package [SOIC_N]	R-14	
AD8548ARZ-R7	-40°C to +125°C	14-Lead Standard Small Outline Package [SOIC_N]	R-14	

¹ Z = RoHS Compliant Part.

NOTES

NOTES