

Octal, 14-Bit, 40/65 MSPS Serial LVDS 1.8 V Analog-to-Digital Converter

FEATURES

- ▶ Low power: 55 mW per channel at 65 MSPS with scalable power options
- ▶ SNR = 75.5 dB (to Nyquist)
- ▶ SFDR = 91.6 dBc (to Nyquist)
- ▶ DNL = ±0.6 LSB (typical), INL = ±1.1 LSB (typical)
- ▶ Serial LVDS (ANSI-644, default)
  - ▶ Low power, reduced signal option (similar to IEEE 1596.3)
- ▶ Data and frame clock outputs
- ▶ 650 MHz full power analog bandwidth
- ▶ 2 V p-p input voltage range
- ▶ 1.8 V supply operation
- ▶ Serial port control
  - ▶ Full chip and individual channel power-down modes
  - ▶ Flexible bit orientation
  - ▶ Built-in and custom digital test pattern generation
  - ▶ Programmable clock and data alignment
  - ▶ Programmable output resolution
  - ▶ Standby mode

APPLICATIONS

- ▶ Medical imaging and nondestructive ultrasound
- ▶ Portable ultrasound and digital beam-forming systems
- ▶ Quadrature and diversity radio receivers
- ▶ Optical networking
- ▶ Test equipment

GENERAL DESCRIPTION

The AD9257 is an octal, 14-bit, 40 MSPS and 65 MSPS analog-to-digital converter (ADC) with an on-chip sample-and-hold circuit designed for low cost, low power, small size, and ease of use. The product operates at a conversion rate of up to 65 MSPS and is optimized for outstanding dynamic performance and low power in applications where a small package size is critical.

The ADC requires a single 1.8 V power supply and LVPECL-/CMOS-/LVDS-compatible sample rate clock for full performance operation. No external reference or driver components are required for many applications.

The ADC automatically multiplies the sample rate clock for the appropriate LVDS serial data rate. A data clock output (DCO) for capturing data on the output and a frame clock output (FCO) for signaling a new output byte are provided. Individual channel power-down is supported and typically consumes less than 2 mW when all channels are disabled.

FUNCTIONAL BLOCK DIAGRAM

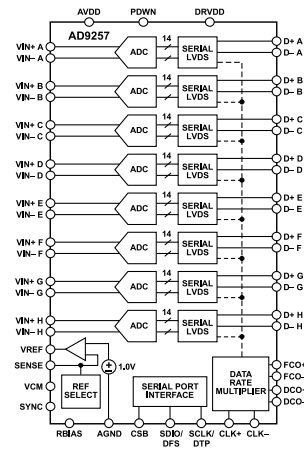

Figure 1.

PRODUCT HIGHLIGHTS

1. Small Footprint. Eight ADCs are contained in a small, space-saving package.
2. Low Power of 55 mW/Channel at 65 MSPS with Scalable Power Options.
3. Ease of Use. A data clock output (DCO) is provided that operates at frequencies of up to 455 MHz and supports double data rate (DDR) operation.
4. User Flexibility. The SPI control offers a wide range of flexible features to meet specific system requirements.
5. Pin Compatible with the AD9637 (12-Bit Octal ADC).

The ADC contains several features designed to maximize flexibility and minimize system cost, such as programmable clock and data alignment and programmable digital test pattern generation. The available digital test patterns include built-in deterministic and pseudorandom patterns, along with custom user-defined test patterns entered via the serial port interface (SPI).

The AD9257 is available in an RoHS-compliant, 64-lead LFCSP. It is specified over the industrial temperature range of -40°C to +85°C. This product is protected by a U.S. patent.

**TABLE OF CONTENTS**

Features.....	1	Digital Outputs and Timing.....	23
Applications.....	1	Built-In Output Test Modes.....	28
Functional Block Diagram.....	1	Output Test Modes.....	28
Product Highlights.....	1	Serial Port Interface (SPI).....	29
General Description.....	1	Configuration Using the SPI.....	29
Specifications.....	3	Hardware Interface.....	30
DC Specifications.....	3	Configuration Without the SPI.....	30
AC Specifications.....	4	SPI Accessible Features.....	30
Digital Specifications.....	5	Memory Map.....	31
Switching Specifications.....	6	Reading the Memory Map Register Table.....	31
Timing Specifications.....	7	Memory Map Register Table.....	31
Timing Diagrams.....	7	Memory Map Register Descriptions.....	34
Absolute Maximum Ratings.....	9	Applications Information.....	37
Thermal Characteristics.....	9	Design Guidelines.....	37
ESD Caution.....	9	Power and Ground Recommendations.....	37
Pin Configuration and Function Descriptions.....	10	Clock Stability Considerations.....	37
Typical Performance Characteristics.....	12	Exposed Pad Thermal Heat Slug	
AD9257-65.....	12	Recommendations.....	37
AD9257-40.....	15	VCM.....	37
Equivalent Circuits.....	18	Reference Decoupling.....	37
Theory of Operation.....	19	SPI Port.....	37
Analog Input Considerations.....	19	Outline Dimensions.....	38
Voltage Reference.....	20	Ordering Guide.....	38
Clock Input Considerations.....	21	Evaluation Boards.....	38
Power Dissipation and Power-Down Mode.....	23		

**REVISION HISTORY****1/2023—Rev. A to Rev. B**

Changes to Figure 5.....	10
Changes to Digital Outputs and Timing Section.....	23
Changes to Table 11.....	26
Changes to Table 12.....	27
Changes to Output Test Modes Section.....	28
Changes to Table 17.....	31
Updated Outline Dimensions.....	38

## SPECIFICATIONS

## DC SPECIFICATIONS

AVDD = 1.8 V, DRVDD = 1.8 V, 2 V p-p differential input, 1.0 V internal reference, AIN = -1.0 dBFS, unless otherwise noted.

Table 1.

Parameter <sup>1</sup>	Temp	AD9257-40			AD9257-65			Unit
		Min	Typ	Max	Min	Typ	Max	
RESOLUTION		14			14			Bits
ACCURACY								
No Missing Codes	Full		Guaranteed			Guaranteed		
Offset Error	Full	-0.6	-0.3	+0.1	-0.7	-0.3	+0.1	% FSR
Offset Matching	Full	0	0.2	0.6	0	0.23	0.6	% FSR
Gain Error	Full	-6.0	-2.1	+2.0	-6.0	-2.9	+1.0	% FSR
Gain Matching	Full	-1.0	+1.7	+5.0	-1.0	+1.6	+5.0	% FSR
Differential Nonlinearity (DNL)	Full	-1.0	-0.5/+0.8	+1.7	-1.0	±0.6	+1.6	LSB
Integral Nonlinearity (INL)	Full	-3.1	±1.1	+3.1	-4.0	±1.1	+4.0	LSB
TEMPERATURE DRIFT								
Offset Error	Full		±2			±2		ppm/°C
INTERNAL VOLTAGE REFERENCE								
Output Voltage (1 V Mode)	Full	0.98	0.99	1.01	0.98	0.99	1.01	V
Load Regulation at 1.0 mA (V <sub>REF</sub> = 1 V)	Full		2			2		mV
Input Resistance	Full		7.5			7.5		kΩ
INPUT-REFERRED NOISE								
V <sub>REF</sub> = 1.0 V	25°C		0.91			0.94		LSB rms
ANALOG INPUTS								
Differential Input Voltage (V <sub>REF</sub> = 1 V)	Full		2			2		V p-p
Common-Mode Voltage	Full		0.9			0.9		V
Common-Mode Range	Full	0.5		1.3	0.5		1.3	V
Differential Input Resistance			5.2			5.2		kΩ
Differential Input Capacitance	Full		3.5			3.5		pF
POWER SUPPLY								
AVDD	Full	1.7	1.8	1.9	1.7	1.8	1.9	V
DRVDD	Full	1.7	1.8	1.9	1.7	1.8	1.9	V
I <sub>AVDD</sub>	Full		147	156		198	211	mA
I <sub>DRVDD</sub> (ANSI-644 Mode)	Full		53	85		60	93	mA
I <sub>DRVDD</sub> (Reduced Range Mode)	25°C		38			45		mA
TOTAL POWER CONSUMPTION								
Total Power Dissipation (Eight Channels, ANSI-644 Mode)	Full		360	434		464	547	mW
Total Power Dissipation (Eight Channels, Reduced Range Mode)	25°C		333			437		mW
Power-Down Dissipation	25°C		1			1		mW
Standby Dissipation <sup>2</sup>	25°C		74			92		mW

<sup>1</sup> See the AN-835 Application Note, *Understanding High Speed ADC Testing and Evaluation*, for definitions and for details on how these tests were completed.

<sup>2</sup> Can be controlled via the SPI.

## SPECIFICATIONS

## AC SPECIFICATIONS

AVDD = 1.8 V, DRVDD = 1.8 V, 2 V p-p differential input, 1.0 V internal reference, AIN = -1.0 dBFS, unless otherwise noted. CLK divider = 8 used for typical characteristics at input frequency  $\geq 19.7$  MHz.

Table 2.

Parameter <sup>1</sup>	Temp	AD9257-40			AD9257-65			Unit
		Min	Typ	Max	Min	Typ	Max	
SIGNAL-TO-NOISE RATIO (SNR)								
$f_{IN} = 9.7$ MHz	25°C		75.9			75.7		dBFS
$f_{IN} = 19.7$ MHz	Full	73.5	75.8		73.3	75.6		dBFS
$f_{IN} = 30.5$ MHz	25°C		75.7			75.5		dBFS
$f_{IN} = 63.5$ MHz	25°C					74.9		dBFS
$f_{IN} = 69.5$ MHz	25°C		74.7					dBFS
$f_{IN} = 123.4$ MHz	25°C					73.2		dBFS
SIGNAL-TO-NOISE AND DISTORTION RATIO (SINAD)								
$f_{IN} = 9.7$ MHz	25°C		75.8			75.6		dBFS
$f_{IN} = 19.7$ MHz	Full	72.5	75.7		72.0	75.6		dBFS
$f_{IN} = 30.5$ MHz	25°C		75.6			75.4		dBFS
$f_{IN} = 63.5$ MHz	25°C					74.8		dBFS
$f_{IN} = 69.5$ MHz	25°C		74.5					dBFS
$f_{IN} = 123.4$ MHz	25°C					72.8		dBFS
EFFECTIVE NUMBER OF BITS (ENOB)								
$f_{IN} = 9.7$ MHz	25°C		12.3			12.3		Bits
$f_{IN} = 19.7$ MHz	Full	11.7	12.3		11.7	12.3		Bits
$f_{IN} = 30.5$ MHz	25°C		12.3			12.2		Bits
$f_{IN} = 63.5$ MHz	25°C					12.1		Bits
$f_{IN} = 69.5$ MHz	25°C		12.1					Bits
$f_{IN} = 123.4$ MHz	25°C					11.8		Bits
SPURIOUS-FREE DYNAMIC RANGE (SFDR)								
$f_{IN} = 9.7$ MHz	25°C		96			96		dBc
$f_{IN} = 19.7$ MHz	Full	80	96		79	96		dBc
$f_{IN} = 30.5$ MHz	25°C		97			91		dBc
$f_{IN} = 63.5$ MHz	25°C					95		dBc
$f_{IN} = 69.5$ MHz	25°C		87					dBc
$f_{IN} = 123.4$ MHz	25°C					83		dBc
WORST HARMONIC (SECOND OR THIRD)								
$f_{IN} = 9.7$ MHz	25°C		-99			-99		dBc
$f_{IN} = 19.7$ MHz	Full		-96	-80		-98	-79	dBc
$f_{IN} = 30.5$ MHz	25°C		-100			-91		dBc
$f_{IN} = 63.5$ MHz	25°C					-98		dBc
$f_{IN} = 69.5$ MHz	25°C		-87					dBc
$f_{IN} = 123.4$ MHz	25°C					-83		dBc
WORST OTHER (EXCLUDING SECOND OR THIRD)								
$f_{IN} = 9.7$ MHz	25°C		-96			-96		dBc
$f_{IN} = 19.7$ MHz	Full		-99	-86		-96	-88	dBc
$f_{IN} = 30.5$ MHz	25°C		-97			-98		dBc
$f_{IN} = 63.5$ MHz	25°C					-95		dBc
$f_{IN} = 69.5$ MHz	25°C		-98					dBc
$f_{IN} = 123.4$ MHz	25°C					-94		dBc

## SPECIFICATIONS

Table 2. (Continued)

Parameter <sup>1</sup>	Temp	AD9257-40			AD9257-65			Unit
		Min	Typ	Max	Min	Typ	Max	
TWO-TONE INTERMODULATION DISTORTION (IMD)—AIN1 AND AIN2 = -7.0 dBFS								
$f_{IN1} = 8 \text{ MHz}$ , $f_{IN2} = 10 \text{ MHz}$	25°C		95					dBc
$f_{IN1} = 30 \text{ MHz}$ , $f_{IN2} = 32 \text{ MHz}$	25°C					92		dBc
CROSSTALK <sup>2</sup>	25°C		-100			-98		dB
Crosstalk (Ovrange Condition) <sup>3</sup>	25°C		-92			-94		dB
POWER SUPPLY REJECTION RATIO (PSRR) <sup>4</sup>	25°C							
AVDD			52			52		dB
DRVDD			73			71		dB
ANALOG INPUT BANDWIDTH, FULL POWER	25°C		650			650		MHz

<sup>1</sup> See the AN-835 Application Note, *Understanding High Speed ADC Testing and Evaluation*, for definitions and for details on how these tests were completed.

<sup>2</sup> Crosstalk is measured at 10 MHz with -1.0 dBFS analog input on one channel and no input on the adjacent channel.

<sup>3</sup> Ovrange condition is 3 dB above the full-scale input range.

<sup>4</sup> PSRR is measured by injecting a sinusoidal signal at 10 MHz to the power supply pin and measuring the output spur on the FFT. PSRR is calculated as the ratio of the amplitudes of the spur voltage over the pin voltage, expressed in decibels.

## DIGITAL SPECIFICATIONS

AVDD = 1.8 V, DRVDD = 1.8 V, 2 V p-p differential input, 1.0 V internal reference, AIN = -1.0 dBFS, unless otherwise noted.

Table 3.

Parameter <sup>1</sup>	Temp	Min	Typ	Max	Unit
CLOCK INPUTS (CLK+, CLK-)					
Logic Compliance			CMOS/LVDS/LVPECL		
Differential Input Voltage <sup>2</sup>	Full	0.2		3.6	V p-p
Input Voltage Range	Full	AGND - 0.2		AVDD + 0.2	V
Input Common-Mode Voltage	Full		0.9		V
Input Resistance (Differential)	25°C		15		kΩ
Input Capacitance	25°C		4		pF
LOGIC INPUTS (PDWN, SYNC, SCLK)					
Logic 1 Voltage	Full	1.2		AVDD + 0.2	V
Logic 0 Voltage	Full	0		0.8	V
Input Resistance	25°C		30		kΩ
Input Capacitance	25°C		2		pF
LOGIC INPUT (CSB)					
Logic 1 Voltage	Full	1.2		AVDD + 0.2	V
Logic 0 Voltage	Full	0		0.8	V
Input Resistance	25°C		26		kΩ
Input Capacitance	25°C		2		pF
LOGIC INPUT (SDIO)					
Logic 1 Voltage	Full	1.2		AVDD + 0.2	V
Logic 0 Voltage	Full	0		0.8	V
Input Resistance	25°C		26		kΩ
Input Capacitance	25°C		5		pF
LOGIC OUTPUT (SDIO) <sup>3</sup>					
Logic 1 Voltage ( $I_{OH} = 800 \mu\text{A}$ )	Full		1.79		V
Logic 0 Voltage ( $I_{OL} = 50 \mu\text{A}$ )	Full			0.05	V

## SPECIFICATIONS

Table 3. (Continued)

Parameter <sup>1</sup>	Temp	Min	Typ	Max	Unit
DIGITAL OUTPUTS (D± x), ANSI-644					
Logic Compliance			LVDS		
Differential Output Voltage (V <sub>OD</sub> )	Full	247	350	454	mV
Output Offset Voltage (V <sub>OS</sub> )	Full	1.13	1.21	1.38	V
Output Coding (Default)			Twos complement		
DIGITAL OUTPUTS (D± x), LOW POWER, REDUCED SIGNAL OPTION					
Logic Compliance			LVDS		
Differential Output Voltage (V <sub>OD</sub> )	Full	150	200	250	mV
Output Offset Voltage (V <sub>OS</sub> )	Full	1.13	1.21	1.38	V
Output Coding (Default)			Twos complement		

<sup>1</sup> See the AN-835 Application Note, *Understanding High Speed ADC Testing and Evaluation*, for definitions and for details on how these tests were completed.

<sup>2</sup> This is specified for LVDS and LVPECL only.

<sup>3</sup> This is specified for 13 SDIO/DFS pins sharing the same connection.

## SWITCHING SPECIFICATIONS

AVDD = 1.8 V, DRVDD = 1.8 V, 2 V p-p differential input, 1.0 V internal reference, AIN = -1.0 dBFS, unless otherwise noted.

Table 4.

Parameter <sup>1, 2</sup>	Temp	Min	Typ	Max	Unit
CLOCK <sup>3</sup>					
Input Clock Rate	Full	10		520	MHz
Conversion Rate	Full	10		40/65	MSPS
Clock Pulse Width High (t <sub>EH</sub> )	Full		12.5/7.69		ns
Clock Pulse Width Low (t <sub>EL</sub> )	Full		12.5/7.69		ns
OUTPUT PARAMETERS <sup>3</sup>					
Propagation Delay (t <sub>PD</sub> )	Full	1.5	2.3	3.1	ns
Rise Time (t <sub>R</sub> ) (20% to 80%)	Full		300		ps
Fall Time (t <sub>F</sub> ) (20% to 80%)	Full		300		ps
FCO Propagation Delay (t <sub>FCO</sub> )	Full	1.5	2.3	3.1	ns
DCO Propagation Delay (t <sub>CPD</sub> ) <sup>4</sup>	Full		t <sub>FCO</sub> + (t <sub>SAMPLE</sub> /28)		ns
DCO to Data Delay (t <sub>DATA</sub> ) <sup>4</sup>	Full	(t <sub>SAMPLE</sub> /28) - 300	(t <sub>SAMPLE</sub> /28)	(t <sub>SAMPLE</sub> /28) + 300	ps
DCO to FCO Delay (t <sub>FRAME</sub> ) <sup>4</sup>	Full	(t <sub>SAMPLE</sub> /28) - 300	(t <sub>SAMPLE</sub> /28)	(t <sub>SAMPLE</sub> /28) + 300	ps
Data to Data Skew (t <sub>DATA-MAX</sub> - t <sub>DATA-MIN</sub> )	Full		±50	±200	ps
Wake-Up Time (Standby)	25°C		35		µs
Wake-Up Time (Power-Down) <sup>5</sup>	25°C		375		µs
Pipeline Latency	Full		16		Clock cycles
APERTURE					
Aperture Delay (t <sub>A</sub> )	25°C		1		ns
Aperture Uncertainty (Jitter)	25°C		0.1		ps rms
Out-of-Range Recovery Time	25°C		1		Clock cycles

<sup>1</sup> See the AN-835 Application Note, *Understanding High Speed ADC Testing and Evaluation*, for definitions and for details on how these tests were completed.

<sup>2</sup> Measured on standard FR-4 material.

<sup>3</sup> Can be adjusted via the SPI.

<sup>4</sup> t<sub>SAMPLE</sub>/28 is based on the number of bits divided by 2 because the delays are based on half duty cycles. t<sub>SAMPLE</sub> = 1/f<sub>S</sub>.

<sup>5</sup> Wake-up time is defined as the time required to return to normal operation from power-down mode.

SPECIFICATIONS

TIMING SPECIFICATIONS

Table 5.

Parameter	Description	Limit	Unit
<b>SYNC TIMING REQUIREMENTS</b>			
$t_{SSYNC}$	SYNC to rising edge of CLK+ setup time	0.24	ns typ
$t_{HSYNC}$	SYNC to rising edge of CLK+ hold time	0.40	ns typ
<b>SPI TIMING REQUIREMENTS</b>			
	See <a href="#">Figure 61</a>		
$t_{DS}$	Setup time between the data and the rising edge of SCLK	2	ns min
$t_{DH}$	Hold time between the data and the rising edge of SCLK	2	ns min
$t_{CLK}$	Period of the SCLK	40	ns min
$t_S$	Setup time between CSB and SCLK	2	ns min
$t_H$	Hold time between CSB and SCLK	2	ns min
$t_{HIGH}$	SCLK pulse width high	10	ns min
$t_{LOW}$	SCLK pulse width low	10	ns min
$t_{EN\_SDIO}$	Time required for the SDIO pin to switch from an input to an output relative to the SCLK falling edge (not shown in <a href="#">Figure 61</a> )	10	ns min
$t_{DIS\_SDIO}$	Time required for the SDIO pin to switch from an output to an input relative to the SCLK rising edge (not shown in <a href="#">Figure 61</a> )	10	ns min

TIMING DIAGRAMS

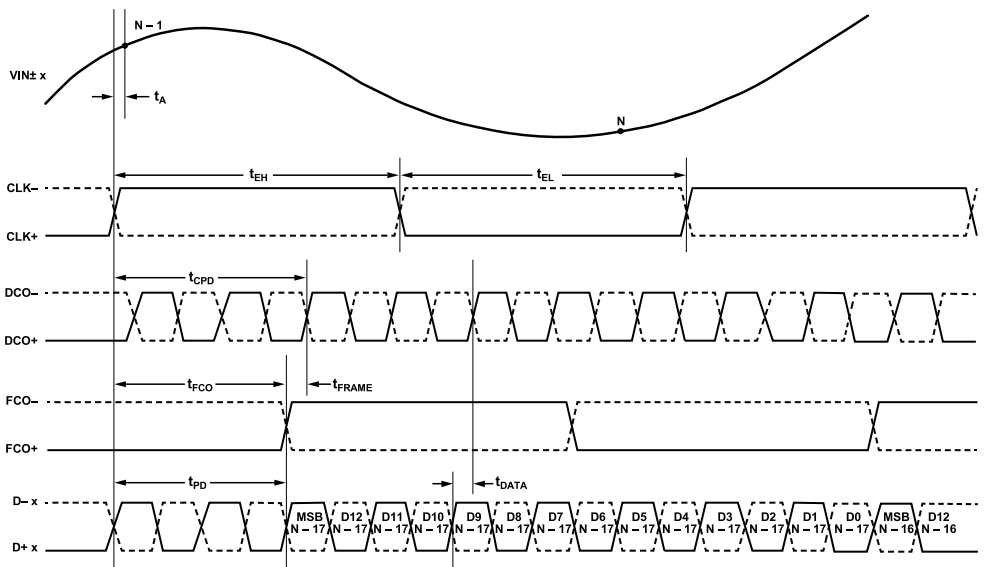

Figure 2. Word-Wise DDR, 1x Frame, 14-Bit Output Mode (Default)

SPECIFICATIONS

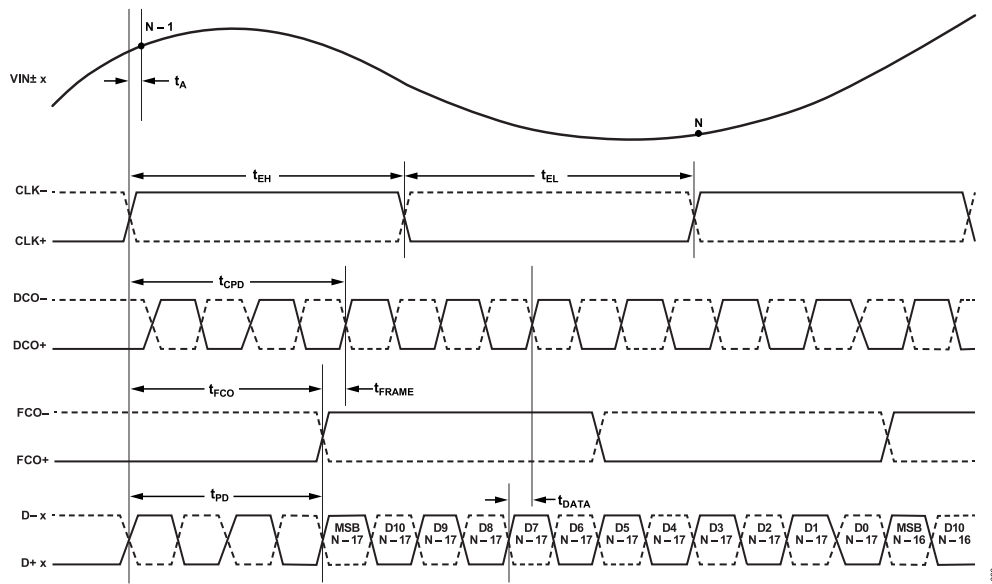

Figure 3. Word-Wise DDR, 1x Frame, 12-Bit Output Mode

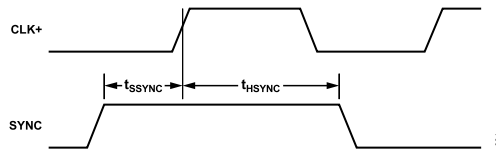

Figure 4. SYNC Input Timing Requirements



## ABSOLUTE MAXIMUM RATINGS

**Table 6.**

Parameter	Rating
Electrical	
AVDD to AGND	-0.3 V to +2.0 V
DRVDD to AGND	-0.3 V to +2.0 V
Digital Outputs (D± x, DCO+, DCO-, FCO+, FCO-) to AGND	-0.3 V to +2.0 V
CLK+, CLK- to AGND	-0.3 V to +2.0 V
VIN+ x, VIN- x to AGND	-0.3 V to +2.0 V
SCLK/DTP, SDIO/DFS, CSB to AGND	-0.3 V to +2.0 V
SYNC, PDWN to AGND	-0.3 V to +2.0 V
RBIAS to AGND	-0.3 V to +2.0 V
VREF, SENSE to AGND	-0.3 V to +2.0 V
Environmental	
Operating Temperature Range (Ambient)	-40°C to +85°C
Maximum Junction Temperature	150°C
Lead Temperature (Soldering, 10 sec)	300°C
Storage Temperature Range (Ambient)	-65°C to +150°C

Stresses at or above those listed under Absolute Maximum Ratings may cause permanent damage to the product. This is a stress rating only; functional operation of the product at these or any other conditions above those indicated in the operational section of this specification is not implied. Operation beyond the maximum operating conditions for extended periods may affect product reliability.

## THERMAL CHARACTERISTICS

The exposed paddle must be soldered to the ground plane for the LFCSP package. Soldering the exposed paddle to the PCB

increases the reliability of the solder joints and maximizes the thermal capability of the package.

**Table 7. Thermal Resistance**

Package Type	Airflow Velocity (m/sec)	$\theta_{JA}^{1,2}$	$\theta_{JC}^{1,3}$	$\theta_{JB}^{1,4}$	$\Psi_{JT}^{1,2}$	Unit
64-Lead LFCSP 9 mm × 9 mm (CP-64-17)	0	22.3	1.4	N/A	0.1	°C/W
	1.0	19.5	N/A	11.8	0.2	°C/W
	2.5	17.5	N/A	N/A	0.2	°C/W

<sup>1</sup> Per JEDEC 51-7, plus JEDEC 25-5 2S2P test board.

<sup>2</sup> Per JEDEC JESD51-2 (still air) or JEDEC JESD51-6 (moving air).

<sup>3</sup> Per MIL-Std 883, Method 1012.1.

<sup>4</sup> Per JEDEC JESD51-8 (still air).

Typical  $\theta_{JA}$  is specified for a 4-layer PCB with a solid ground plane. As shown in Table 7, airflow improves heat dissipation, which reduces  $\theta_{JA}$ . In addition, metal in direct contact with the package leads from metal traces, through holes, ground, and power planes reduces  $\theta_{JA}$ .

## ESD CAUTION



**ESD (electrostatic discharge) sensitive device.** Charged devices and circuit boards can discharge without detection. Although this product features patented or proprietary protection circuitry, damage may occur on devices subjected to high energy ESD. Therefore, proper ESD precautions should be taken to avoid performance degradation or loss of functionality.

PIN CONFIGURATION AND FUNCTION DESCRIPTIONS

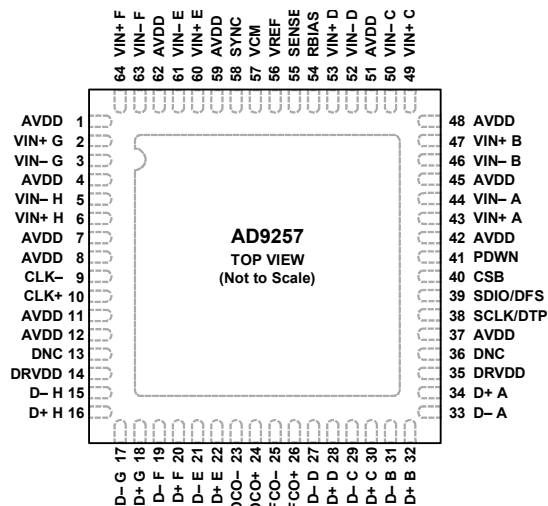

NOTES  
 1. DNC = DO NOT CONNECT. DO NOT CONNECT TO THIS PIN.  
 2. THE EXPOSED PAD MUST BE CONNECTED TO ANALOG GROUND.

Figure 5. Pin Configuration, Top View

Table 8. Pin Function Descriptions

Pin No.	Mnemonic	Description
0, EP	AGND, Exposed Pad	Analog Ground, Exposed Pad. The exposed thermal pad on the bottom of the package provides the analog ground for the part. This exposed pad must be connected to ground for proper operation.
1, 4, 7, 8, 11, 12, 37, 42, 45, 48, 51, 59, 62	AVDD	1.8 V Analog Supply.
13, 36	DNC	Do Not Connect.
14, 35	DRVDD	1.8 V Digital Output Driver Supply.
2, 3	VIN+ G, VIN- G	ADC G Analog Input True, ADC G Analog Input Complement.
5, 6	VIN- H, VIN+ H	ADC H Analog Input Complement, ADC H Analog Input True.
9, 10	CLK-, CLK+	Input Clock Complement, Input Clock True.
15, 16	D- H, D+ H	ADC H Digital Output Complement, ADC H Digital Output True.
17, 18	D- G, D+ G	ADC G Digital Output Complement, ADC G Digital Output True.
19, 20	D- F, D+ F	ADC F Digital Output Complement, ADC F Digital Output True.
21, 22	D- E, D+ E	ADC E Digital Output Complement, ADC E Digital Output True.
23, 24	DCO-, DCO+	Data Clock Digital Output Complement, Data Clock Digital Output True.
25, 26	FCO-, FCO+	Frame Clock Digital Output Complement, Frame Clock Digital Output True.
27, 28	D- D, D+ D	ADC D Digital Output Complement, ADC D Digital Output True.
29, 30	D- C, D+ C	ADC C Digital Output Complement, ADC C Digital Output True.
31, 32	D- B, D+ B	ADC B Digital Output Complement, ADC B Digital Output True.
33, 34	D- A, D+ A	ADC A Digital Output Complement, ADC A Digital Output True.
38	SCLK/DTP	Serial Clock (SCLK)/Digital Test Pattern (DTP).
39	SDIO/DFS	Serial Data Input/Output (SDIO)/Data Format Select (DFS).
40	CSB	Chip Select Bar.
41	PDWN	Power-Down.
43, 44	VIN+ A, VIN- A	ADC A Analog Input True, ADC A Analog Input Complement.
46, 47	VIN- B, VIN+ B	ADC B Analog Input Complement, ADC B Analog Input True.
49, 50	VIN+ C, VIN- C	ADC C Analog Input True, ADC C Analog Input Complement.
52, 53	VIN- D, VIN+ D	ADC D Analog Input Complement, ADC D Analog Input True.
54	RBIAS	Sets analog current bias. Connect to 10 kΩ (1% tolerance) resistor to ground.

**PIN CONFIGURATION AND FUNCTION DESCRIPTIONS****Table 8. Pin Function Descriptions (Continued)**

Pin No.	Mnemonic	Description
55	SENSE	Reference Mode Selection.
56	VREF	Voltage Reference Input/Output.
57	VCM	Analog Output Voltage at Midsupply. Sets common mode of the analog inputs.
58	SYNC	Digital Input. SYNC input to clock divider. 30 k $\Omega$ internal pull-down.
60, 61	VIN+ E, VIN- E	ADC E Analog Input True, ADC E Analog Input Complement.
63, 64	VIN- F, VIN+ F	ADC F Analog Input Complement, ADC F Analog Input True.

TYPICAL PERFORMANCE CHARACTERISTICS

AD9257-65

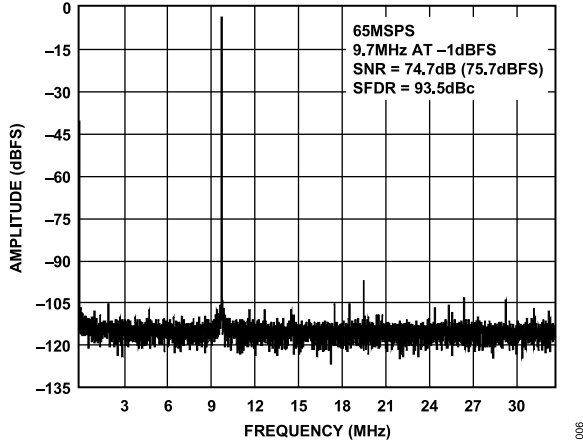

Figure 6. Single-Tone 16k FFT with  $f_{IN} = 9.7$  MHz,  $f_{SAMPLE} = 65$  MSPS

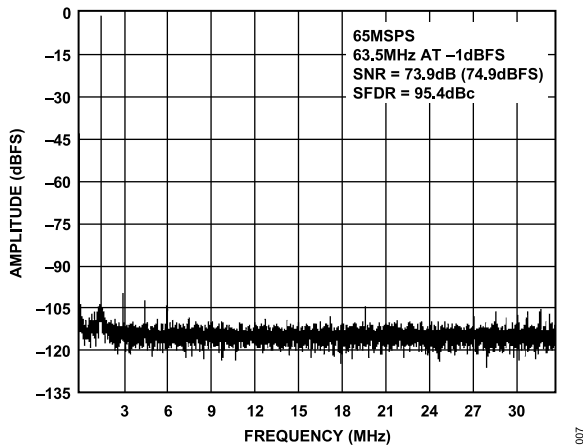

Figure 7. Single-Tone 16k FFT with  $f_{IN} = 63.5$  MHz,  $f_{SAMPLE} = 65$  MSPS, CLK Divider = 8

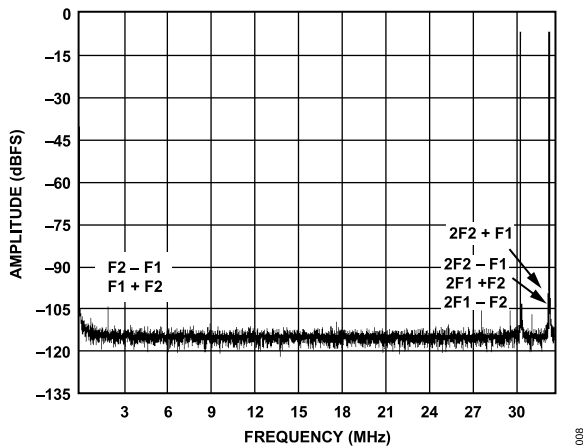

Figure 8. Two-Tone 16k FFT with  $f_{IN1} = 30$  MHz and  $f_{IN2} = 32$  MHz,  $f_{SAMPLE} = 65$  MSPS

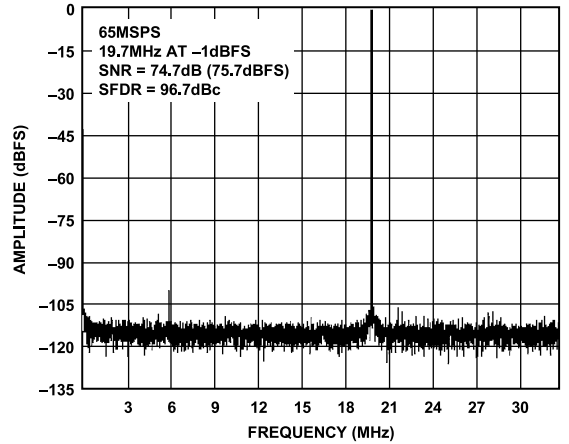

Figure 9. Single-Tone 16k FFT with  $f_{IN} = 19.7$  MHz,  $f_{SAMPLE} = 65$  MSPS, CLK Divider = 8

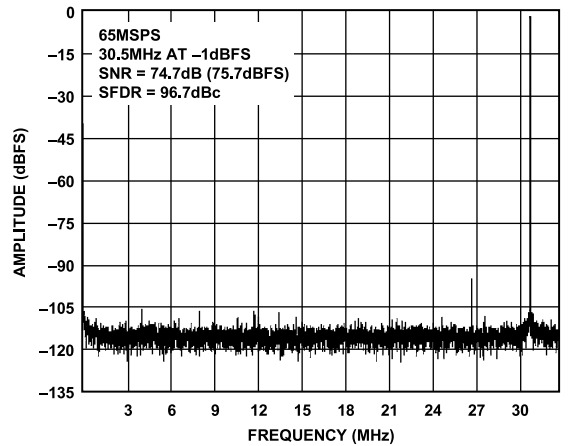

Figure 10. Single-Tone 16k FFT with  $f_{IN} = 30.5$  MHz,  $f_{SAMPLE} = 65$  MSPS, CLK Divider = 8

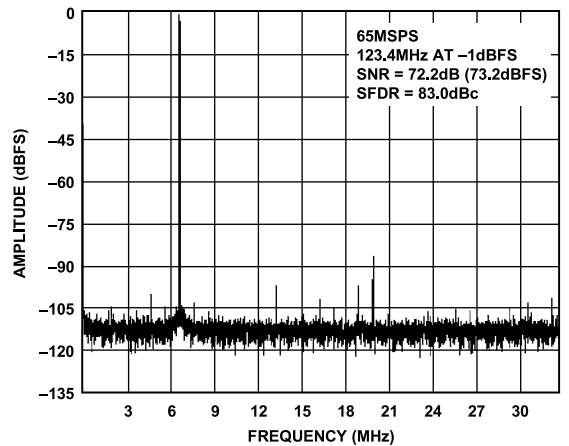

Figure 11. Single-Tone 16k FFT with  $f_{IN} = 123.4$  MHz,  $f_{SAMPLE} = 65$  MSPS, CLK Divider = 8

TYPICAL PERFORMANCE CHARACTERISTICS

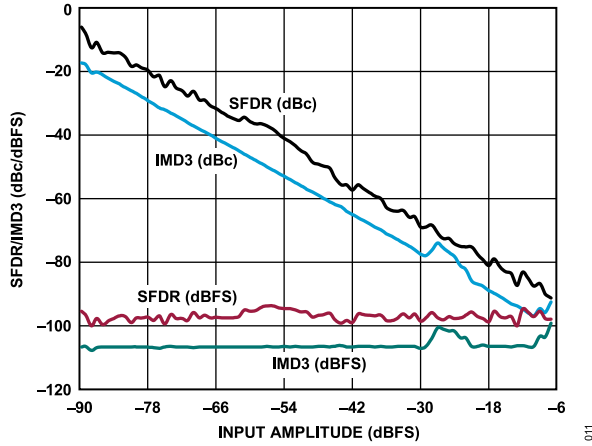

Figure 12. Two-Tone SFDR/IMD3 vs. Input Amplitude (AIN) with  $f_{IN1} = 30$  MHz and  $f_{IN2} = 32$  MHz,  $f_{SAMPLE} = 65$  MSPS

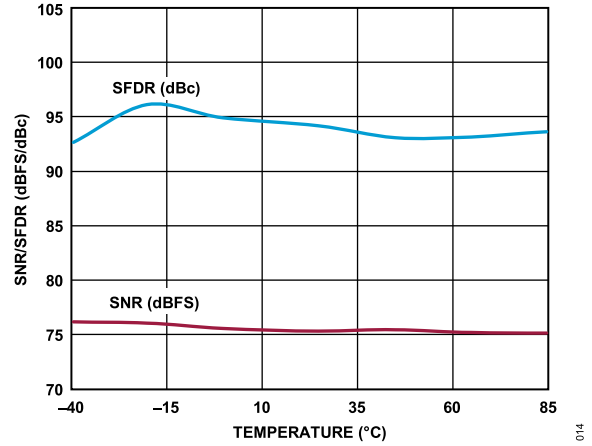

Figure 15. SNR/SFDR vs. Temperature,  $f_{IN} = 9.7$  MHz,  $f_{SAMPLE} = 65$  MSPS

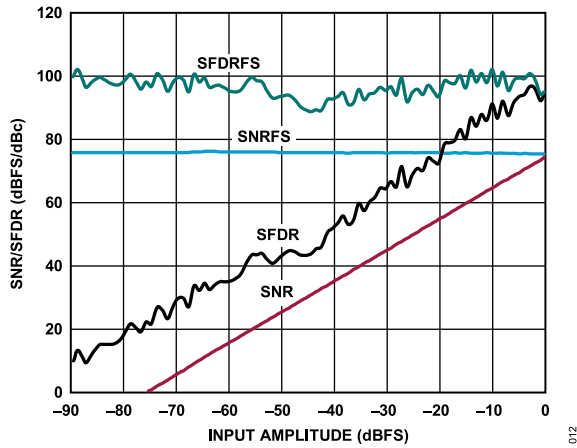

Figure 13. SNR/SFDR vs. Analog Input Level,  $f_{IN} = 9.7$  MHz,  $f_{SAMPLE} = 65$  MSPS

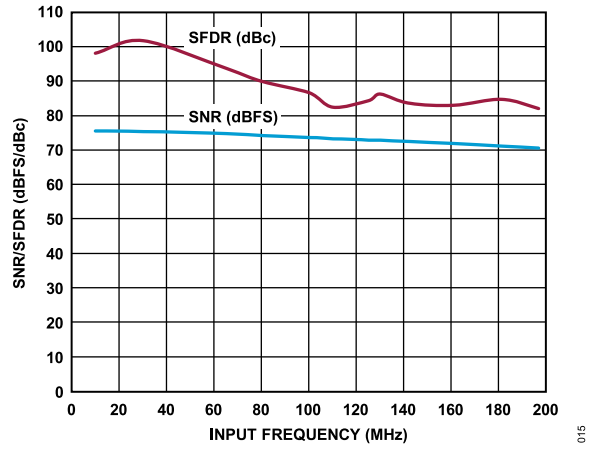

Figure 16. SNR/SFDR vs.  $f_{IN}$ ,  $f_{SAMPLE} = 65$  MSPS

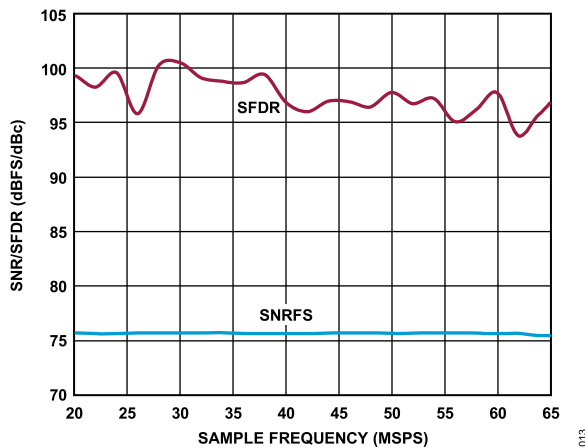

Figure 14. SNR/SFDR vs. Encode,  $f_{IN} = 19.7$  MHz, CLK Divider = 4

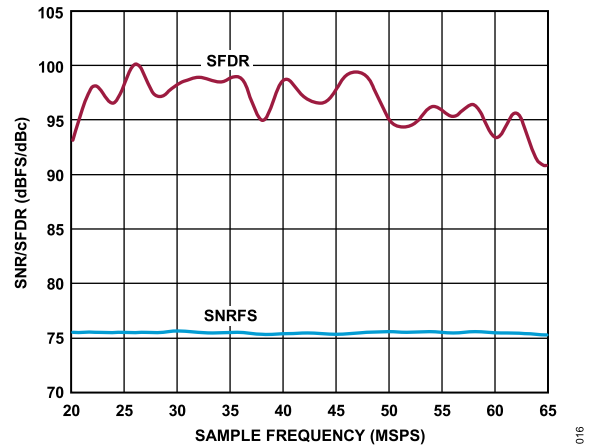

Figure 17. SNR/SFDR vs. Encode,  $f_{IN} = 30.5$  MHz, CLK Divider = 4

TYPICAL PERFORMANCE CHARACTERISTICS

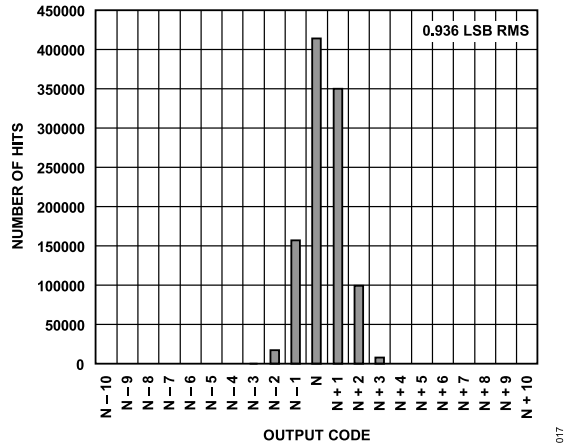

Figure 18. Input-Referred Noise Histogram,  $f_{\text{SAMPLE}} = 65 \text{ MSPS}$

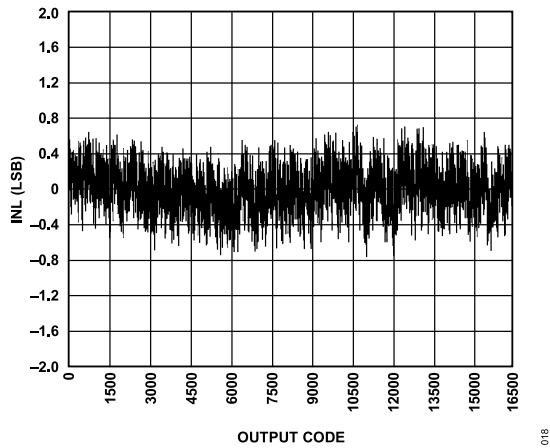

Figure 19. INL,  $f_{\text{IN}} = 9.7 \text{ MHz}$ ,  $f_{\text{SAMPLE}} = 65 \text{ MSPS}$

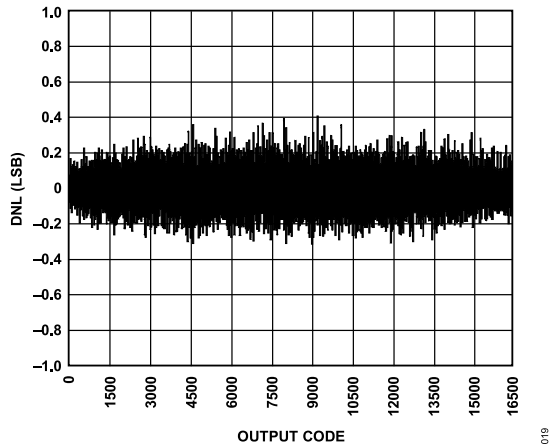

Figure 20. DNL,  $f_{\text{IN}} = 9.7 \text{ MHz}$ ,  $f_{\text{SAMPLE}} = 65 \text{ MSPS}$

TYPICAL PERFORMANCE CHARACTERISTICS

AD9257-40

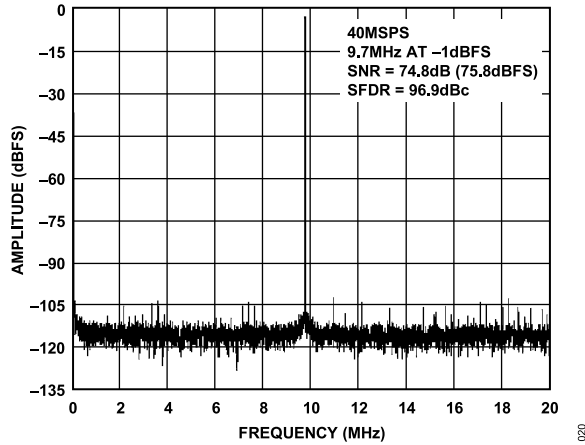

Figure 21. Single-Tone 16k FFT with  $f_{IN} = 9.7$  MHz,  $f_{SAMPLE} = 40$  MSPS

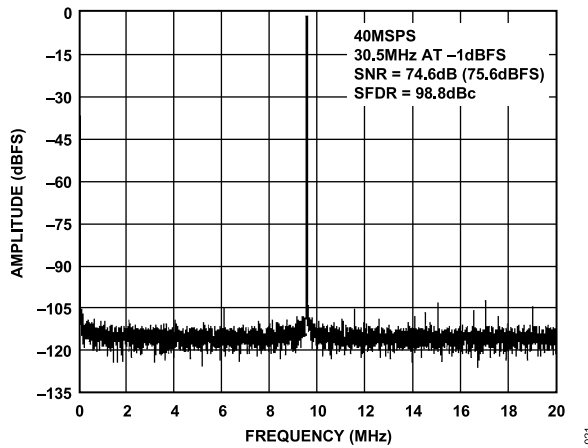

Figure 22. Single-Tone 16k FFT with  $f_{IN} = 30.5$  MHz,  $f_{SAMPLE} = 40$  MSPS, CLK Divider = 8

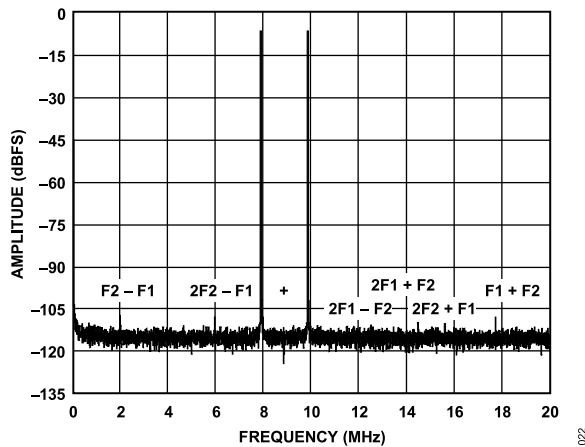

Figure 23. Two-Tone 16k FFT with  $f_{IN1} = 8$  MHz and  $f_{IN2} = 10$  MHz,  $f_{SAMPLE} = 40$  MSPS

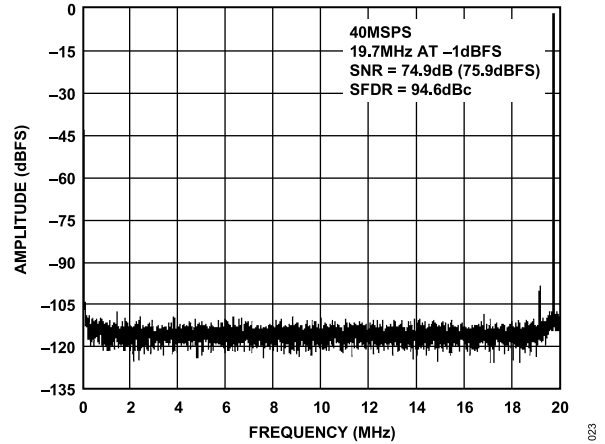

Figure 24. Single-Tone 16k FFT with  $f_{IN} = 19.7$  MHz,  $f_{SAMPLE} = 40$  MSPS, CLK Divider = 8

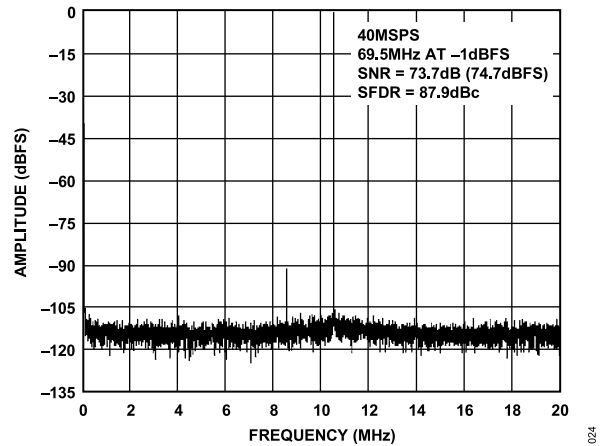

Figure 25. Single-Tone 16k FFT with  $f_{IN} = 69.5$  MHz,  $f_{SAMPLE} = 40$  MSPS, CLK Divider = 8

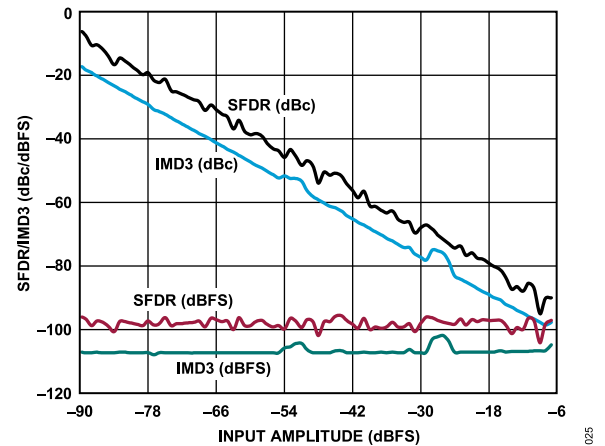

Figure 26. Two-Tone SFDR/IMD3 vs. Input Amplitude ( $A_{IN}$ ) with  $f_{IN1} = 30$  MHz and  $f_{IN2} = 32$  MHz,  $f_{SAMPLE} = 40$  MSPS

TYPICAL PERFORMANCE CHARACTERISTICS

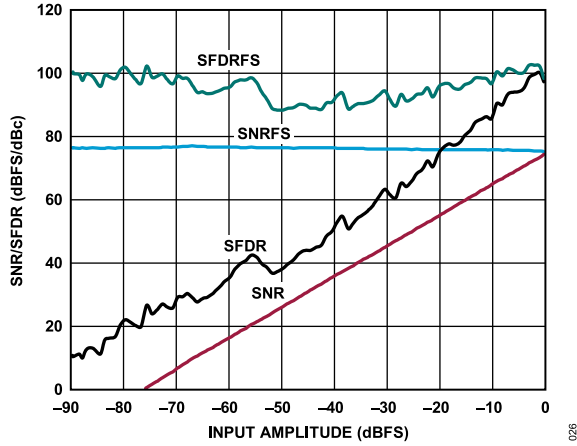

Figure 27. SNR/SFDR vs. Analog Input Level,  $f_{IN} = 9.7$  MHz,  $f_{SAMPLE} = 40$  MSPS

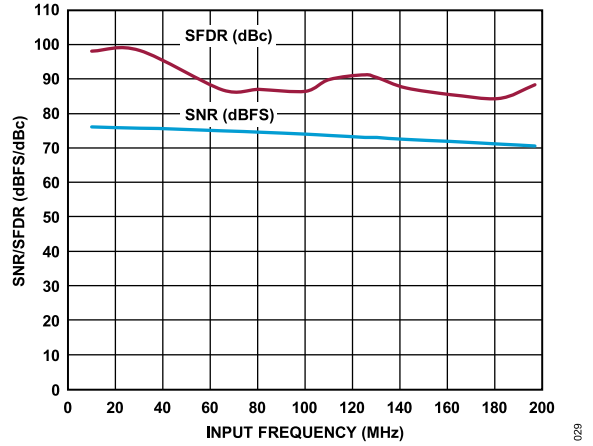

Figure 30. SNR/SFDR vs.  $f_{IN}$ ,  $f_{SAMPLE} = 40$  MSPS

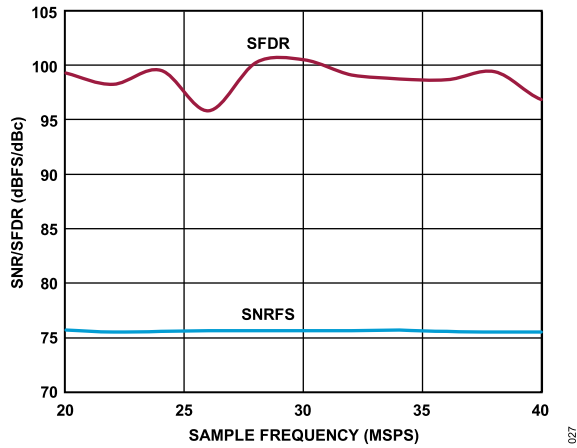

Figure 28. SNR/SFDR vs. Encode,  $f_{IN} = 19.7$  MHz, CLK Divider = 4

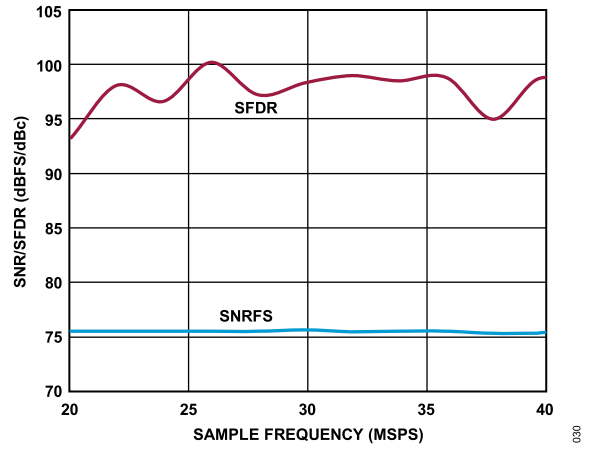

Figure 31. SNR/SFDR vs. Encode,  $f_{IN} = 30.5$  MHz, CLK Divider = 4

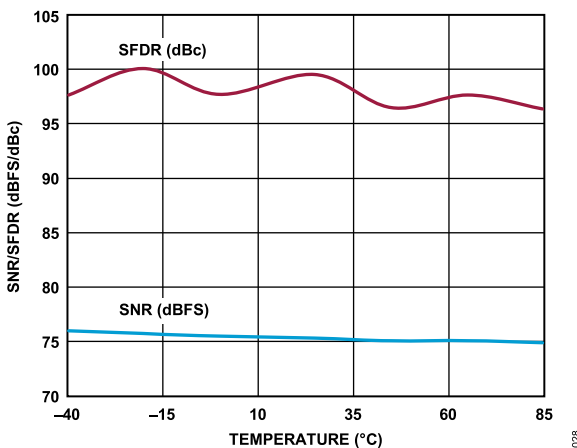

Figure 29. SNR/SFDR vs. Temperature,  $f_{IN} = 9.7$  MHz,  $f_{SAMPLE} = 40$  MSPS

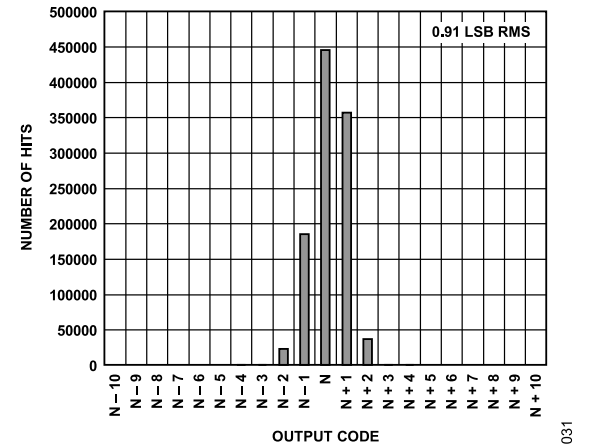

Figure 32. Input-Referred Noise Histogram,  $f_{SAMPLE} = 40$  MSPS



## TYPICAL PERFORMANCE CHARACTERISTICS

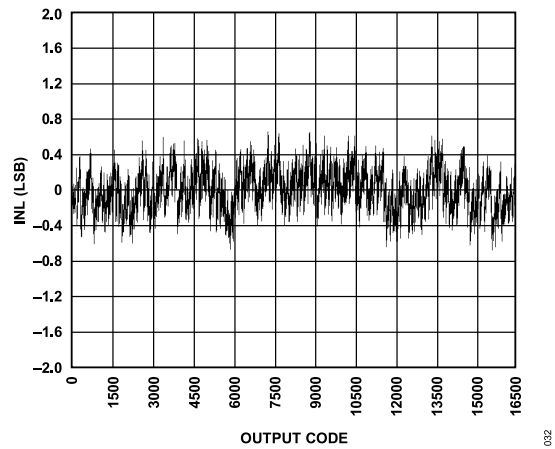

Figure 33. INL,  $f_{IN} = 9.7 \text{ MHz}$ ,  $f_{SAMPLE} = 40 \text{ MSPS}$

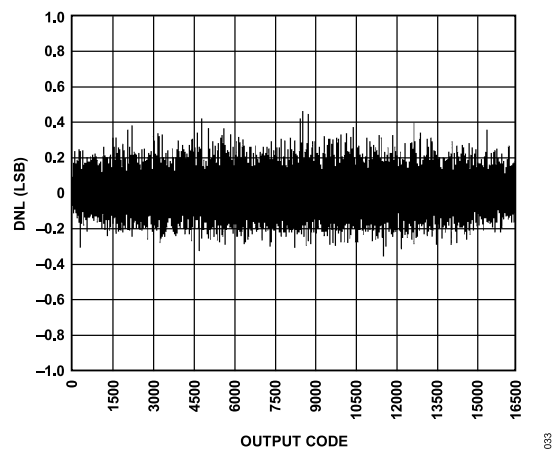

Figure 34. DNL,  $f_{IN} = 9.7 \text{ MHz}$ ,  $f_{SAMPLE} = 40 \text{ MSPS}$

EQUIVALENT CIRCUITS

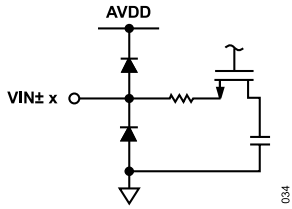

Figure 35. Equivalent Analog Input Circuit

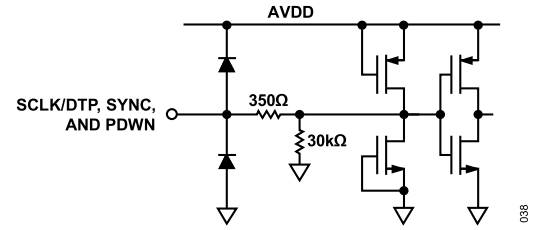

Figure 39. Equivalent SCLK/DTP, SYNC, and PDWN Input Circuit

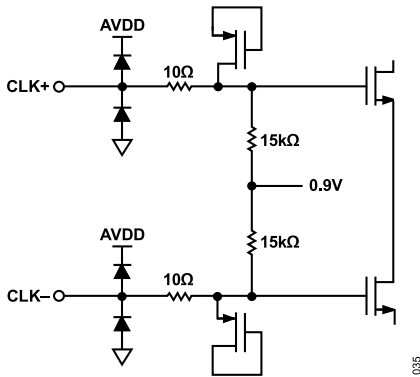

Figure 36. Equivalent Clock Input Circuit

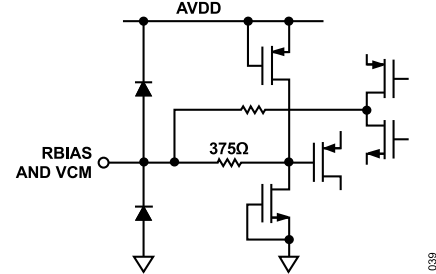

Figure 40. Equivalent RBIAS, VCM Circuit

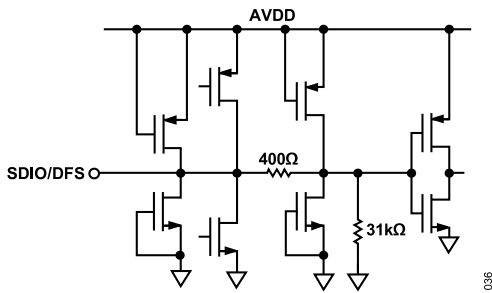

Figure 37. Equivalent SDIO/DFS Input Circuit

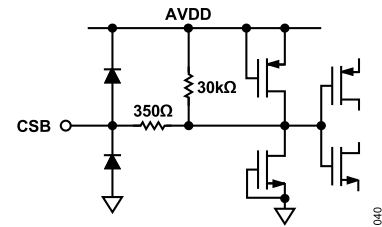

Figure 41. Equivalent CSB Input Circuit

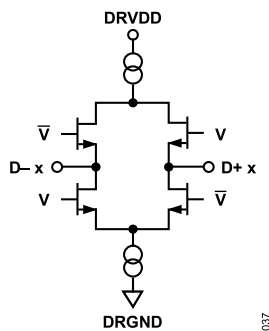

Figure 38. Equivalent Digital Output Circuit

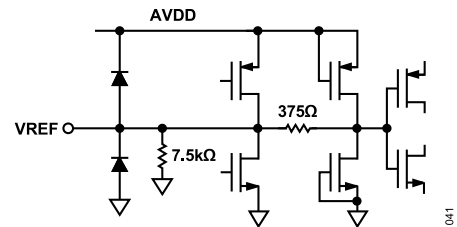

Figure 42. Equivalent VREF Circuit

## THEORY OF OPERATION

The AD9257 is a multistage, pipelined ADC. Each stage provides sufficient overlap to correct for flash errors in the preceding stage. The quantized outputs from each stage are combined into a final 14-bit result in the digital correction logic. The serializer transmits this converted data in a 14-bit output. The pipelined architecture permits the first stage to operate with a new input sample while the remaining stages operate with preceding samples. Sampling occurs on the rising edge of the clock.

Each stage of the pipeline, excluding the last, consists of a low resolution flash ADC connected to a switched-capacitor DAC and an interstage residue amplifier (for example, a multiplying digital-to-analog converter (MDAC)). The residue amplifier magnifies the difference between the reconstructed DAC output and the flash input for the next stage in the pipeline. One bit of redundancy is used in each stage to facilitate digital correction of flash errors. The last stage simply consists of a flash ADC.

The output staging block aligns the data, corrects errors, and passes the data to the output buffers. The data is then serialized and aligned to the frame and data clocks.

## ANALOG INPUT CONSIDERATIONS

The analog input to the AD9257 is a differential switched-capacitor circuit designed for processing differential input signals. This circuit can support a wide common-mode range while maintaining excellent performance. By using an input common-mode voltage of midsupply, users can minimize signal-dependent errors and achieve optimum performance.

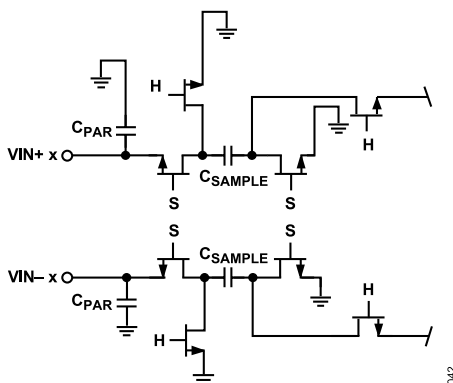

Figure 43. Switched-Capacitor Input Circuit

The clock signal alternately switches the input circuit between sample mode and hold mode (see Figure 43). When the input circuit is switched to sample mode, the signal source must be capable of charging the sample capacitors and settling within one-half of a clock cycle. A small resistor in series with each input can help reduce the peak transient current injected from the output stage of the driving source. In addition, low Q inductors or ferrite beads can be placed on each leg of the input to reduce high differential capacitance at the analog inputs and, therefore, achieve the maximum bandwidth of the ADC. Such use of low Q inductors or ferrite beads is required when driving the converter

front end at high IF frequencies. Either a differential capacitor or two single-ended capacitors can be placed on the inputs to provide a matching passive network. This ultimately creates a low-pass filter at the input to limit unwanted broadband noise. See the [AN-742 Application Note](#), the [AN-827 Application Note](#), and the *Analog Dialogue* article “Transformer-Coupled Front-End for Wideband A/D Converters” (Volume 39, April 2005) for more information. In general, the precise values depend on the application.

## Input Common Mode

The analog inputs of the AD9257 are not internally dc-biased. Therefore, in ac-coupled applications, the user must provide this bias externally. Setting the device so that  $V_{CM} = AVDD/2$  is recommended for optimum performance, but the device can function over a wider range with reasonable performance, as shown in Figure 44.

An on-board, common-mode voltage reference is included in the design and is available from the VCM pin. The VCM pin must be decoupled to ground by a 0.1  $\mu$ F capacitor, as described in the [Applications Information](#) section.

Maximum SNR performance is achieved by setting the ADC to the largest span in a differential configuration. In the case of the AD9257, the largest input span available is 2 V p-p.

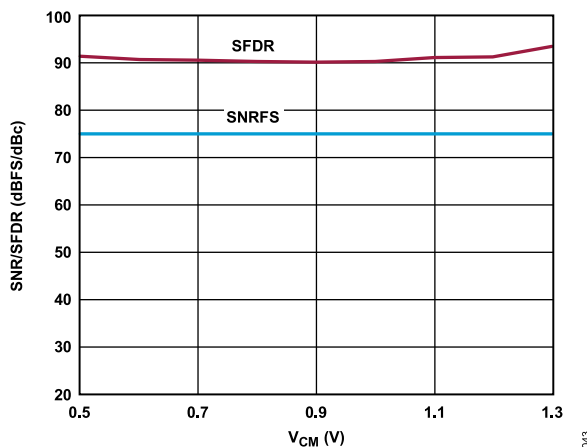

Figure 44. SNR/SFDR vs. Common-Mode Voltage,  $f_{IN} = 9.7$  MHz,  $f_{SAMPLE} = 65$  MSPS

## Differential Input Configurations

There are several ways to drive the AD9257 either actively or passively. However, optimum performance is achieved by driving the analog input differentially. Using a differential double balun configuration to drive the AD9257 provides excellent performance and a flexible interface to the ADC (see Figure 46) for baseband applications.

For applications where SNR is a key parameter, differential transformer coupling is the recommended input configuration (see Figure 47), because the noise performance of most amplifiers is not adequate to achieve the true performance of the AD9257.

**THEORY OF OPERATION**

Regardless of the configuration, the value of the shunt capacitor, C, is dependent on the input frequency and may need to be reduced or removed.

It is not recommended to drive the AD9257 input single-ended.

**VOLTAGE REFERENCE**

A stable and accurate 1.0 V voltage reference is built into the AD9257. VREF can be configured using either the internal 1.0 V reference or an externally applied 1.0 V reference voltage. The various reference modes are summarized in the sections that follow. The VREF pin should be externally decoupled to ground with a low ESR, 1.0  $\mu$ F capacitor in parallel with a low ESR, 0.1  $\mu$ F ceramic capacitor.

**Internal Reference Connection**

A comparator within the AD9257 detects the potential at the SENSE pin and configures the reference into two possible modes, which are summarized in Table 9. If SENSE is grounded, the reference amplifier switch is connected to the internal resistor divider (see Figure 45), setting VREF to 1.0 V.

**Table 9. Reference Configuration Summary**

Selected Mode	SENSE Voltage (V)	Resulting VREF (V)	Resulting Differential Span (V p-p)
Fixed Internal Reference	AGND to 0.2	1.0 internal	2.0
Fixed External Reference	AVDD	1.0 applied to external VREF pin	2.0

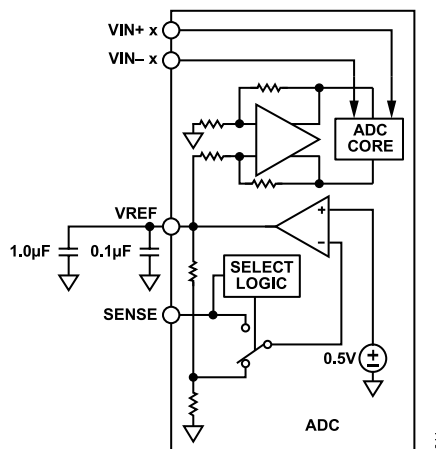

**Figure 45. Internal Reference Configuration**

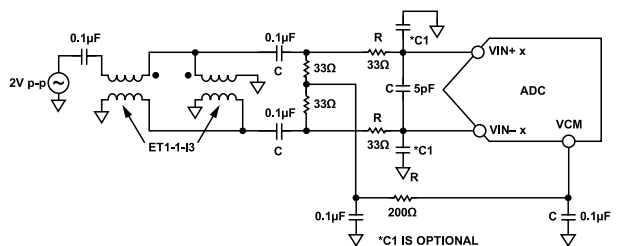

**Figure 46. Differential Double Balun Input Configuration for Baseband Applications**

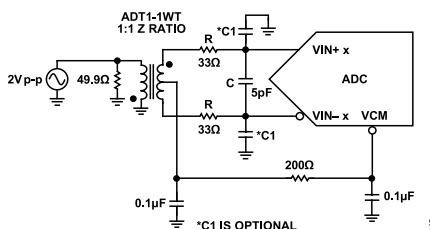

**Figure 47. Differential Transformer-Coupled Configuration for Baseband Applications**

## THEORY OF OPERATION

If the internal reference of the AD9257 is used to drive multiple converters to improve gain matching, the loading of the reference by the other converters must be considered. Figure 48 shows how the internal reference voltage is affected by loading.

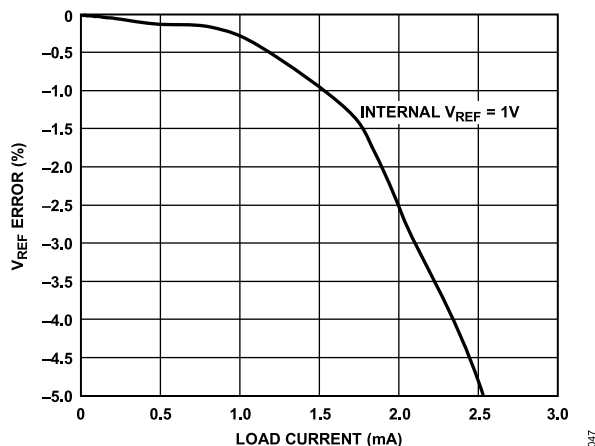

Figure 48.  $V_{REF}$  Error vs. Load Current

## External Reference Operation

The use of an external reference may be necessary to enhance the gain accuracy of the ADC or improve thermal drift characteristics. Figure 49 shows the typical drift characteristics of the internal reference in 1.0 V mode.

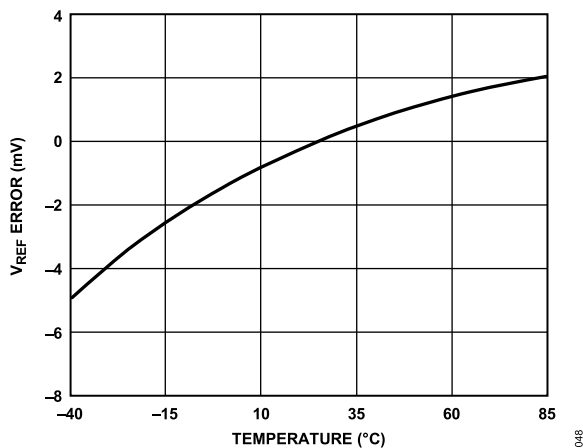

Figure 49. Typical  $V_{REF}$  Drift

When the SENSE pin is tied to AVDD, the internal reference is disabled, allowing the use of an external reference. An internal reference buffer loads the external reference with an equivalent 7.5 k $\Omega$  load (see Figure 42). The internal buffer generates the positive and negative full-scale references for the ADC core. Therefore, the external reference must be limited to a maximum of 1.0 V. It is not recommended to leave the SENSE pin floating.

## CLOCK INPUT CONSIDERATIONS

For optimum performance, clock the AD9257 sample clock inputs, CLK+ and CLK-, with a differential signal. The signal is typically ac-coupled into the CLK+ and CLK- pins via a transformer or capacitors. These pins are biased internally (see Figure 36) and require no external bias.

### Clock Input Options

The AD9257 has a very flexible clock input structure. The clock input can be a CMOS, LVDS, LVPECL, or sine wave signal. Regardless of the type of signal being used, clock source jitter is of the utmost concern, as described in the [Jitter Considerations](#) section.

Figure 50 and Figure 51 show two preferred methods for clocking the AD9257 (at clock rates of up to 520 MHz prior to the internal CLK divider). A low jitter clock source is converted from a single-ended signal to a differential signal using either an RF transformer or an RF balun.

The RF balun configuration is recommended for clock frequencies between 65 MHz and 520 MHz, and the RF transformer is recommended for clock frequencies from 10 MHz to 200 MHz. The back-to-back Schottky diodes across the transformer/balun secondary winding limit clock excursions into the AD9257 to approximately 0.8 V p-p differential.

This limit helps prevent the large voltage swings of the clock from feeding through to other portions of the AD9257 while preserving the fast rise and fall times of the signal that are critical to a low jitter performance. However, the diode capacitance comes into play at frequencies above 500 MHz. Care must be taken in choosing the appropriate signal limiting diode.

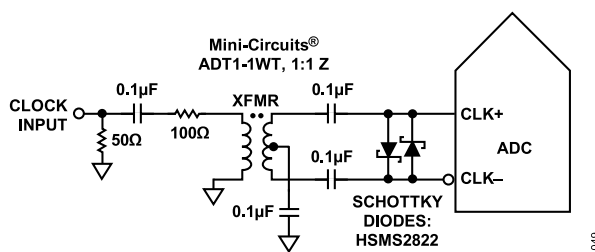

Figure 50. Transformer-Coupled Differential Clock (Up to 200 MHz)

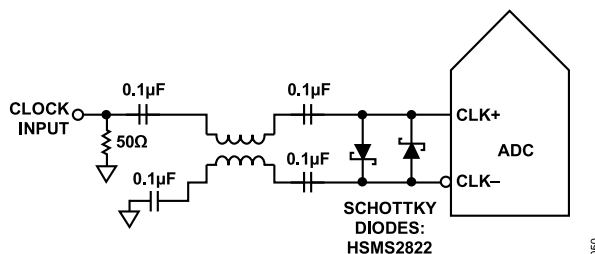

Figure 51. Balun-Coupled Differential Clock (65 MHz to 520 MHz)

## THEORY OF OPERATION

If a low jitter clock source is not available, another option is to ac couple a differential PECL signal to the sample clock input pins, as shown in Figure 52. The AD9510/AD9511/AD9512/AD9513/AD9514/AD9515/AD9516/AD9517 clock drivers offer excellent jitter performance.

A third option is to ac couple a differential LVDS signal to the sample clock input pins, as shown in Figure 53. The AD9510/AD9511/AD9512/AD9513/AD9514/AD9515/AD9516/AD9517 clock drivers offer excellent jitter performance.

In some applications, it may be acceptable to drive the sample clock inputs with a single-ended 1.8 V CMOS signal. In such applications, drive the CLK+ pin directly from a CMOS gate, and bypass the CLK- pin to ground with a 0.1  $\mu$ F capacitor (see Figure 54).

### Input Clock Divider

The AD9257 contains an input clock divider with the ability to divide the input clock by integer values between 1 and 8.

The AD9257 clock divider can be synchronized using the external SYNC input. Bit 0 and Bit 1 of Register 0x109 allow the clock divider to be resynchronized on every SYNC signal or only on the first SYNC signal after the register is written. A valid SYNC causes the clock divider to reset to its initial state. This synchronization

feature allows multiple parts to have their clock dividers aligned to guarantee simultaneous input sampling.

### Clock Duty Cycle

Typical high speed ADCs use both clock edges to generate a variety of internal timing signals and, as a result, may be sensitive to clock duty cycle. Commonly, a  $\pm 5\%$  tolerance is required on the clock duty cycle to maintain dynamic performance characteristics.

The AD9257 contains a duty cycle stabilizer (DCS) that retimes the nonsampling (falling) edge, providing an internal clock signal with a nominal 50% duty cycle. This allows the user to provide a wide range of clock input duty cycles without affecting the performance of the AD9257. Noise and distortion performance are nearly flat for a wide range of duty cycles with the DCS on.

Jitter in the rising edge of the input is still of concern and is not easily reduced by the internal stabilization circuit. The duty cycle control loop does not function for clock rates less than 20 MHz, nominally. The loop has a time constant associated with it that must be considered in applications in which the clock rate can change dynamically. A wait time of 1.5  $\mu$ s to 5  $\mu$ s is required after a dynamic clock frequency increase or decrease before the DCS loop is relocked to the input signal.

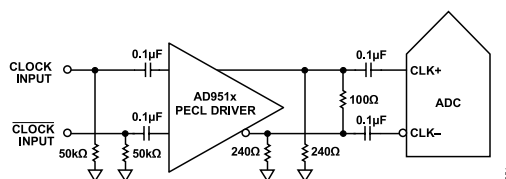

Figure 52. Differential PECL Sample Clock (Up to 520 MHz)

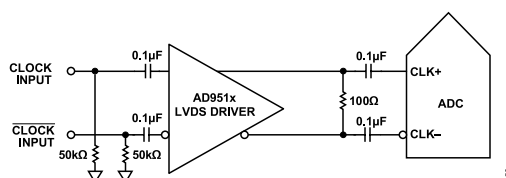

Figure 53. Differential LVDS Sample Clock (Up to 520 MHz)

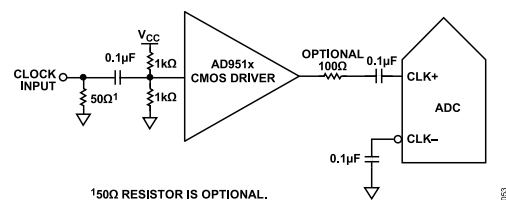

Figure 54. Single-Ended 1.8 V CMOS Input Clock (Up to 200 MHz)

## THEORY OF OPERATION

### Jitter Considerations

High speed, high resolution ADCs are sensitive to the quality of the clock input. The degradation in SNR at a given input frequency ( $f_A$ ) due only to aperture jitter ( $t_j$ ) can be calculated by

$$\text{SNR Degradation} = 20 \log_{10} \left( \frac{1}{2\pi \times f_A \times t_j} \right)$$

In this equation, the rms aperture jitter represents the root mean square of all jitter sources, including the clock input, analog input signal, and ADC aperture jitter specifications. IF undersampling applications are particularly sensitive to jitter (see [Figure 55](#)).

The clock input should be treated as an analog signal in cases where aperture jitter may affect the dynamic range of the AD9257. Power supplies for clock drivers should be separated from the ADC output driver supplies to avoid modulating the clock signal with digital noise. Low jitter, crystal-controlled oscillators make the best clock sources. If the clock is generated from another type of source (by gating, dividing, or other methods), it should be retimed by the original clock at the last step.

Refer to the [AN-501 Application Note](#) and the [AN-756 Application Note](#) for more in-depth information about jitter performance as it relates to ADCs.

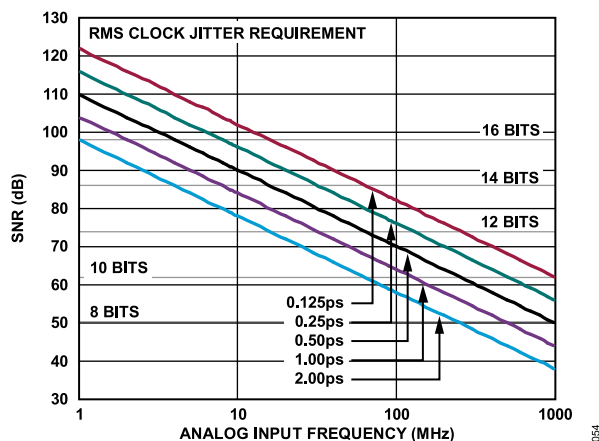

Figure 55. Ideal SNR vs. Input Frequency and Jitter

### POWER DISSIPATION AND POWER-DOWN MODE

As shown in [Figure 56](#), the power dissipated by the AD9257 is proportional to its sample rate. The digital power dissipation does not vary significantly because it is determined primarily by the DRVDD supply and bias current of the LVDS output drivers.

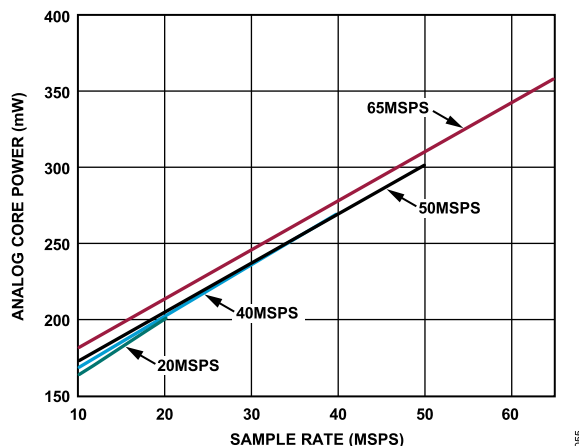

Figure 56. Analog Core Power vs.  $f_{\text{SAMPLE}}$  for  $f_{\text{IN}} = 9.7 \text{ MHz}$

The AD9257 is placed in power-down mode either by the SPI port or by asserting the PDWN pin high. In this state, the ADC typically dissipates 1 mW. During power-down, the output drivers are placed in a high impedance state. Asserting the PDWN pin low returns the AD9257 to its normal operating mode. Note that PDWN is referenced to the digital output driver supply (DRVDD) and should not exceed that supply voltage.

Low power dissipation in power-down mode is achieved by shutting down the reference, reference buffer, biasing networks, and clock. Internal capacitors are discharged when entering power-down mode and then must be recharged when returning to normal operation. As a result, wake-up time is related to the time spent in power-down mode, and shorter power-down cycles result in proportionally shorter wake-up times. When using the SPI port interface, the user can place the ADC in power-down mode or standby mode. Standby mode allows the user to keep the internal reference circuitry powered when faster wake-up times are required. See the [Memory Map](#) section for more details on using these features.

### DIGITAL OUTPUTS AND TIMING

The AD9257 differential outputs conform to the ANSI-644 LVDS standard on default power-up. This can be changed to a low power, reduced signal option (similar to the IEEE 1596.3 standard) via the SPI. The LVDS driver current is derived on chip and sets the output current at each output equal to a nominal 3.5 mA. A 100  $\Omega$  differential termination resistor placed at the LVDS receiver inputs results in a nominal 350 mV swing (or 700 mV p-p differential) at the receiver.

When operating in reduced range mode, the output current is reduced to 2 mA. This results in a 200 mV swing (or 400 mV p-p differential) across a 100  $\Omega$  termination at the receiver.

The AD9257 LVDS outputs facilitate interfacing with LVDS receivers in custom ASICs and FPGAs for superior switching performance in noisy environments. Single point-to-point net topologies are recommended with a 100  $\Omega$  termination resistor placed as close to the receiver as possible. If there is no far-end receiver termination or

**THEORY OF OPERATION**

there is poor differential trace routing, timing errors may result. To avoid such timing errors, it is recommended that the trace length be less than 24 inches and the differential output traces be close together and at equal lengths. An example of the FCO and data stream with proper trace length and position is shown in Figure 57. An example of LVDS output timing in reduced range mode is shown in Figure 58.

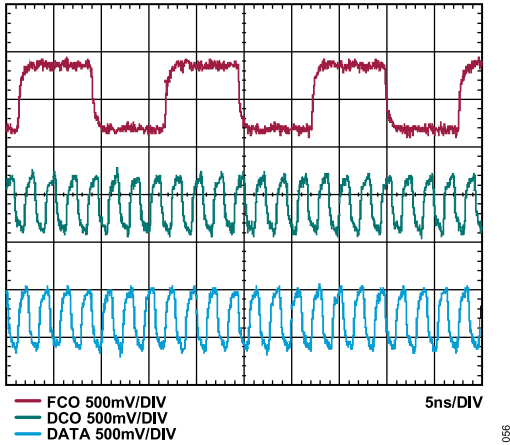

Figure 57. LVDS Output Timing Example in ANSI-644 Mode (Default)

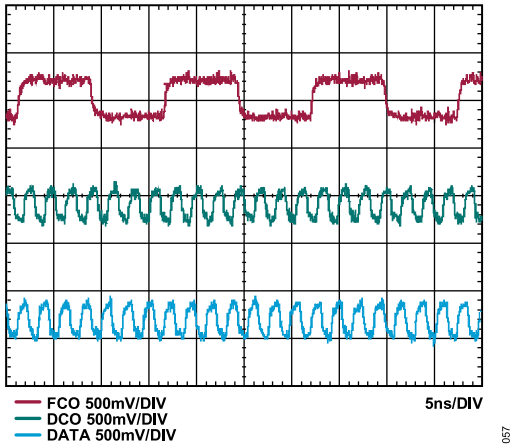

Figure 58. LVDS Output Timing Example in Reduced Range Mode

Figure 59 shows an example of the LVDS output using the ANSI-644 standard (default) data eye and a time interval error (TIE) jitter histogram with trace lengths of less than 24 inches on standard FR-4 material.

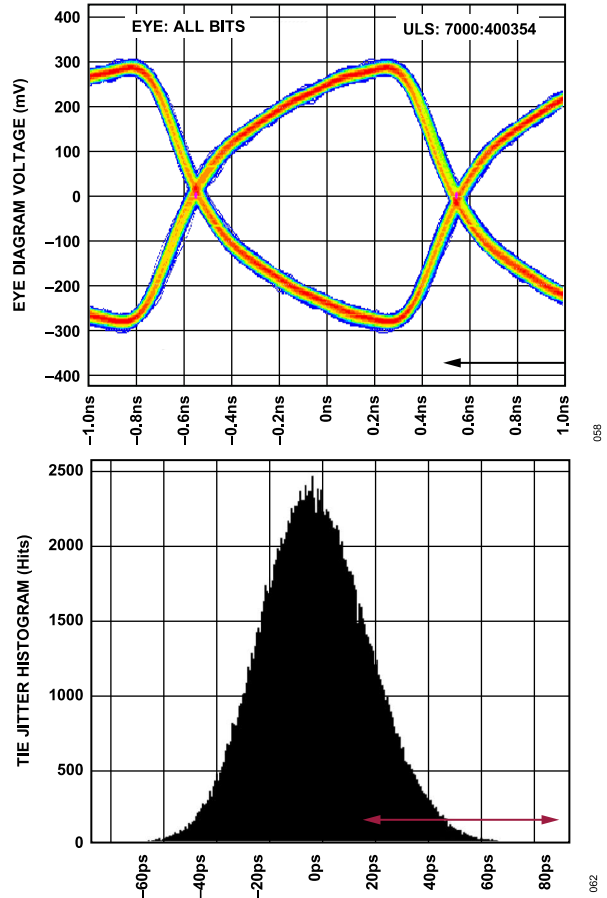

Figure 59. Data Eye for LVDS Outputs in ANSI-644 Mode with Trace Lengths Less Than 24 Inches on Standard FR-4, External 100 Ω Far Termination Only

Figure 60 shows an example of trace lengths exceeding 24 inches on standard FR-4 material. Note that the TIE jitter histogram reflects the decrease of the data eye opening as the edge deviates from the ideal position.

It is the responsibility of the user to determine if the waveforms meet the timing budget of the design when the trace lengths exceed 24 inches. Additional SPI options allow the user to further increase the internal termination (increasing the current) of all eight outputs to drive longer trace lengths, which can be achieved by programming Register 0x15. Even though this option produces sharper rise and fall times on the data edges and is less prone to bit errors, it also increases the power dissipation of the DRVDD supply.



THEORY OF OPERATION

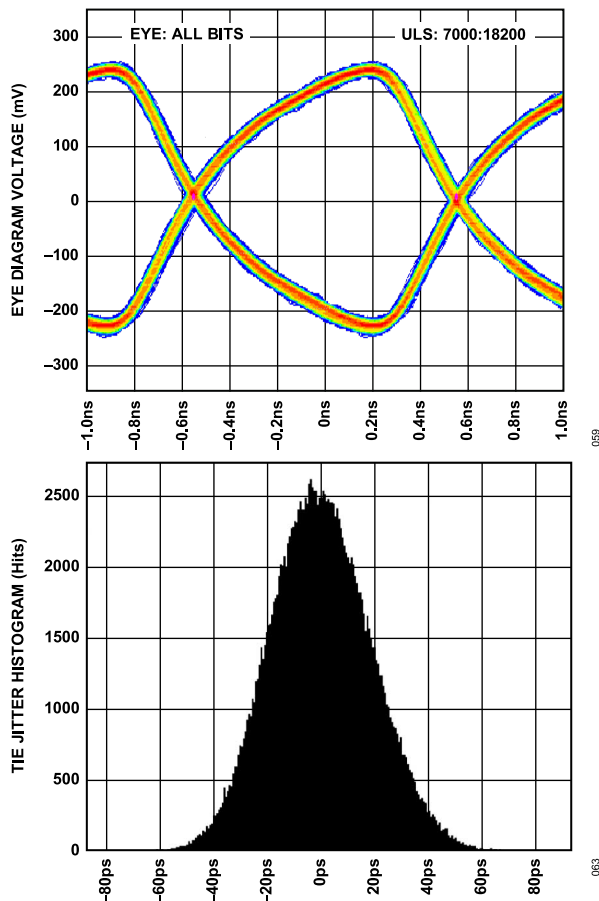

Figure 60. Data Eye for LVDS Outputs in ANSI-644 Mode with Trace Lengths Greater Than 24 Inches on Standard FR-4, External 100 Ω Far Termination Only

Table 10. Digital Output Coding

Input (V)	Condition (V)	Offset Binary Output Mode	Twos Complement Mode
VIN+ - VIN-	< -VREF - 0.5 LSB	00 0000 0000 0000	10 0000 0000 0000
VIN+ - VIN-	= -VREF	00 0000 0000 0000	10 0000 0000 0000
VIN+ - VIN-	= 0	10 0000 0000 0000	00 0000 0000 0000
VIN+ - VIN-	= +VREF - 1.0 LSB	11 1111 1111 1111	01 1111 1111 1111
VIN+ - VIN-	> +VREF - 0.5 LSB	11 1111 1111 1111	01 1111 1111 1111

The default format of the output data is twos complement. Table 10 shows an example of the output coding format. To change the output data format to offset binary, see the Memory Map section.

Data from each ADC is serialized and provided on a separate channel in DDR mode. The data rate for each serial stream is equal to 14 bits times the sample clock rate, with a maximum of 910 Mbps (14 bits × 65 MSPS) = 910 Mbps. The lowest typical conversion rate is 10 MSPS. See the Memory Map section for details on enabling this feature.

## THEORY OF OPERATION

Two output clocks are provided to assist in capturing data from the AD9257. The DCO is used to clock the output data and is equal to  $7\times$  the sample clock (CLK) rate for the default mode of operation. Data is clocked out of the AD9257 and must be captured on the rising and falling edges of the DCO that supports double data rate (DDR) capturing. The FCO is used to signal the start of a new output byte and is equal to the sample clock rate (see the [Timing Diagrams](#) section).

When the SPI is used, the DCO phase can be adjusted in  $60^\circ$  increments relative to the data edge. This enables the user to refine system timing margins if required. The default DCO+ and DCO- timing, as shown in [Figure 2](#), is  $180^\circ$  relative to the output data edge.

A 12-bit serial stream can also be initiated from the SPI. This allows the user to implement and test compatibility to lower resolution

systems. When changing the resolution to a 12-bit serial stream, the data stream is shortened. See [Figure 3](#) for the 12-bit example.

In default mode, as shown in [Figure 2](#), the MSB is first in the data output serial stream. This can be inverted so that the LSB is first in the data output serial stream by using the SPI.

There are 11 digital output test pattern options available that can be initiated through the SPI. This is a useful feature when validating receiver capture and timing (see [Table 11](#) for the output bit sequencing options that are available). Some test patterns have two serial sequential words and can be alternated in various ways, depending on the test pattern chosen. Note that some patterns do not adhere to the data format select option. In addition, custom user-defined test patterns can be assigned in Register 0x19, Register 0x1A, Register 0x1B, and Register 0x1C.

**Table 11. Flexible Output Test Modes**

Output Test Mode Bit Sequence	Pattern Name	Digital Output Word 1	Digital Output Word 2	Subject to Data Format Select	Notes
0000	Off (default)	N/A	N/A	N/A	
0001	Midscale short	1000 0000 0000 (12-bit) 10 0000 0000 0000 (14-bit)	N/A	Yes	Offset binary code shown
0010	+Full-scale short	1111 1111 1111 (12-bit) 11 1111 1111 1111 (14-bit)	N/A	Yes	Offset binary code shown
0011	-Full-scale short	0000 0000 0000 (12-bit) 00 0000 0000 0000 (14-bit)	N/A	Yes	Offset binary code shown
0100	Checkerboard	1010 1010 1010 (12-bit) 10 1010 1010 1010 (14-bit)	0101 0101 0101 (12-bit) 01 0101 0101 (14-bit)	No	
0110	PN sequence short <sup>1</sup>	N/A	N/A	Yes	$PN9ITU\ 0.150X^9 + X^5 + 1$
0111	One-/zero-word toggle	1111 1111 1111 (12-bit) 11 1111 1111 1111 (14-bit)	0000 0000 0000 (12-bit) 00 0000 0000 0000 (14-bit)	No	
1000	User input	Register 0x19 to Register 0x1A	Register 0x1B to Register 0x1C	No	
1001	1-/0-bit toggle	1010 1010 1010 (12-bit) 10 1010 1010 1010 (14-bit)	N/A	No	
1010	1 $\times$ sync	0000 0011 1111 (12-bit) 00 0000 0111 1111 (14-bit)	N/A	No	
1011	One bit high	1000 0000 0000 (12-bit) 10 0000 0000 0000 (14-bit)	N/A	No	Pattern associated with the external pin
1100	Mixed frequency	1010 0011 0011 (12-bit) 10 1000 0110 0111 (14-bit)	N/A	No	

<sup>1</sup> All test mode options except PN sequence short can support 12-bit to 14-bit word lengths to verify data capture to the receiver.

## THEORY OF OPERATION

The PN sequence short pattern produces a pseudorandom bit sequence that repeats itself every  $2^9 - 1$  or 511 bits. A description of the PN sequence and how it is generated can be found in Section 5.1 of the ITU-T 0.150 (05/96) standard. The seed value is all 1s (see [Table 12](#) for the initial values). The output is a parallel representation of the serial PN9 sequence in MSB-first format. The first output word is the first 14 bits of the PN9 sequence in MSB aligned form.

**Table 12. PN Sequence**

Sequence	Initial Value	First Three Output Samples (MSB First) Twos Complement
PN Sequence Short	0x1FE0	0x1DF1, 0x3CC8, 0x294E

Consult the [Memory Map](#) section for information on how to change these additional digital output timing features through the SPI.

### SDIO/DFS Pin

For applications that do not require SPI mode operation, the CSB pin is tied to AVDD, and the SDIO/DFS pin controls the output data format select according to [Table 13](#).

**Table 13. Output Data Format Select Pin Settings**

DFS Pin Voltage	Output Mode
AVDD	Twos complement
GND (Default)	Offset binary

### SCLK/DTP Pin

The SCLK/DTP pin is for use in applications that do not require SPI mode operation. This pin can enable a single digital test pattern if it

and the CSB pin are both held high during device power-up. When SCLK/DTP is tied to AVDD, the ADC channel outputs shift out the following pattern: 10 0000 0000 0000. The FCO and DCO function normally while all channels shift out the repeatable test pattern. This pattern allows the user to perform timing

alignment adjustments among the FCO, DCO, and output data. This pin has an internal 30 kΩ resistor to GND. It can be left unconnected for normal operation.

**Table 14. Digital Test Pattern Pin Settings**

Selected DTP	DTP Voltage	Resulting D± x
Normal Operation	No connect	Normal operation
DTP	AVDD	10 0000 0000 0000

Additional and custom test patterns can also be observed when commanded from the SPI port. Consult the [Memory Map](#) section for information about the options available.

### CSB Pin

The CSB pin should be tied to AVDD for applications that do not require SPI mode operation. Tying CSB high causes all SCLK and SDIO information to be ignored.

### RBIAS Pin

To set the internal core bias current of the ADC, place a 10.0 kΩ, 1% tolerance resistor to ground at the RBIAS pin.

## BUILT-IN OUTPUT TEST MODES

The AD9257 includes a built-in test feature designed to enable verification of the integrity of each data output channel, as well as to facilitate board level debugging. Various output test options are provided to place predictable values on the outputs of the AD9257.

### OUTPUT TEST MODES

The output test options are described in [Table 17](#) at Address 0x0D. When an output test mode is enabled, the analog section of the ADC is disconnected from the digital back-end blocks and the test pattern is run through the output formatting block. Some of the test patterns are subject to output formatting, and some are not. The PN generator from the PN sequence test can be reset by setting Bit

4 of Register 0x0D. These tests can be performed with or without an analog signal (if present, the analog signal is ignored), but they do require an encode clock. For more information, see the [AN-877 Application Note](#), *Interfacing to High Speed ADCs via SPI*.

Data from the output test modes are not necessarily time aligned from channel to channel. In cases where the output test mode data are not aligned across all channels, data alignment is restored when the output test mode bits are disabled and data from the ADC cores are transmitted in normal functional mode (Register 0x0D = 0x00).

## SERIAL PORT INTERFACE (SPI)

The AD9257 serial port interface (SPI) allows the user to configure the converter for specific functions or operations through a structured register space provided inside the ADC. The SPI gives the user added flexibility and customization, depending on the application. Addresses are accessed via the serial port and can be written to or read from via the port. Memory is organized into bytes that can be further divided into fields, which are documented in the [Memory Map](#) section. For detailed operational information, see the [AN-877 Application Note, Interfacing to High Speed ADCs via SPI](#).

### CONFIGURATION USING THE SPI

Three pins define the SPI of this ADC: the SCLK/DTP pin, the SDIO/DFS pin, and the CSB pin (see [Table 15](#)). The SCLK (a serial clock) is used to synchronize the read and write data presented from and to the ADC. The SDIO (serial data input/output) is a dual-purpose pin that allows data to be sent to and read from the internal ADC memory map registers. The CSB (chip select bar) is an active low control that enables or disables the read and write cycles.

**Table 15. Serial Port Interface Pins**

Pin	Function
SCLK	Serial clock. The serial shift clock input, which is used to synchronize serial interface reads and writes.
SDIO	Serial data input/output. A dual-purpose pin that typically serves as an input or an output, depending on the instruction being sent and the relative position in the timing frame.
CSB	Chip select bar. An active low control that gates the read and write cycles.

The falling edge of the CSB, in conjunction with the rising edge of the SCLK, determines the start of the framing. An example of the serial timing and its definitions can be found in [Figure 61](#) and [Table 5](#).

Other modes involving the CSB are available. The CSB can be held low indefinitely, which permanently enables the device; this is called streaming. The CSB can stall high between bytes to allow for additional external timing. When CSB is tied high, SPI functions are placed in high impedance mode. This mode turns on any SPI pin secondary functions.

During an instruction phase, a 16-bit instruction is transmitted. Data follows the instruction phase, and its length is determined by the W0 and W1 bits.

In addition to word length, the instruction phase determines whether the serial frame is a read or write operation, allowing the serial port to be used both to program the chip and to read the contents of the on-chip memory. The first bit of the first byte in a multibyte serial data transfer frame indicates whether a read command or a write command is issued. If the instruction is a readback operation, performing a readback causes the serial data input/output (SDIO) pin to change direction from an input to an output at the appropriate point in the serial frame.

All data is composed of 8-bit words. Data can be sent in MSB-first mode or in LSB-first mode. MSB first is the default on power-up and can be changed via the SPI port configuration register. For more information about this and other features, see the [AN-877 Application Note, Interfacing to High Speed ADCs via SPI](#).

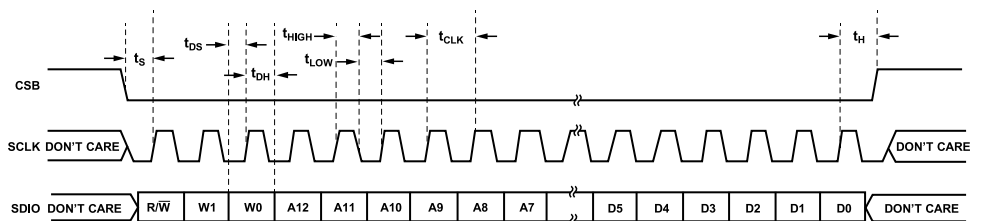

**Figure 61. Serial Port Interface Timing Diagram**

## SERIAL PORT INTERFACE (SPI)

### HARDWARE INTERFACE

The pins described in [Table 15](#) comprise the physical interface between the user programming device and the serial port of the AD9257. The SCLK pin and the CSB pin function as inputs when using the SPI interface. The SDIO pin is bidirectional, functioning as an input during write phases and as an output during readback.

The SPI interface is flexible enough to be controlled by either FPGAs or microcontrollers. One method for SPI configuration is described in detail in the [AN-812 Application Note, Micro-controller-Based Serial Port Interface \(SPI\) Boot Circuit](#).

The SPI port should not be active during periods when the full dynamic performance of the converter is required. Because the SCLK signal, the CSB signal, and the SDIO signal are typically asynchronous to the ADC clock, noise from these signals can degrade converter performance. If the on-board SPI bus is used for other devices, it may be necessary to provide buffers between this bus and the AD9257 to prevent these signals from transitioning at the converter inputs during critical sampling periods.

Some pins serve a dual function when the SPI interface is not being used. When the pins are strapped to DRVDD or ground during device power-on, they are associated with a specific function. [Table 13](#) and [Table 14](#) describe the strappable functions supported on the AD9257.

### CONFIGURATION WITHOUT THE SPI

In applications that do not interface to the SPI control registers, the SDIO/DFS pin, the SCLK/DTP pin, and the PDWN pin serve as standalone CMOS-compatible control pins. When the device is powered up, it is assumed that the user intends to use the

pins as static control lines for the output data format, output digital test pattern, and power-down feature control. In this mode, CSB should be connected to AVDD, which disables the serial port interface.

When the device is in SPI mode, the PDWN pin (if enabled) remains active. For SPI control of power-down, the PDWN pin should be set to its default state.

### SPI ACCESSIBLE FEATURES

[Table 16](#) provides a brief description of the general features that are accessible via the SPI. These features are described in detail in the [AN-877 Application Note, Interfacing to High Speed ADCs via SPI](#). The AD9257 part-specific features are described in detail in the [Memory Map Register Descriptions](#) section following [Table 17](#), the external memory map register table.

**Table 16. Features Accessible Using the SPI**

Feature Name	Description
Mode	Allows the user to set either power-down mode or standby mode
Clock	Allows the user to access the DCS, set the clock divider, set the clock divider phase, and enable the sync

**Table 16. Features Accessible Using the SPI (Continued)**

Feature Name	Description
Offset	Allows the user to digitally adjust the converter offset
Test I/O	Allows the user to set test modes to have known data on output bits
Output Mode	Allows the user to set the output mode
Output Phase	Allows the user to set the output clock polarity
ADC Resolution and Speed Grade	Scalable power consumption options based on resolution and speed grade selection

## MEMORY MAP

### READING THE MEMORY MAP REGISTER TABLE

Each row in the memory map register table has eight bit locations. The memory map is roughly divided into three sections: the chip configuration registers (Address 0x00 to Address 0x02); the device index and transfer registers (Address 0x05 and Address 0xFF); and the global ADC functions registers, including setup, control, and test (Address 0x08 to Address 0x109).

The memory map register table (see [Table 17](#)) lists the default hexadecimal value for each hexadecimal address shown. The column with the heading Bit 7 (MSB) is the start of the default hexadecimal value given. For example, Address 0x05, the device index register, has a hexadecimal default value of 0x3F. This means that in Address 0x05, Bits[7:6] = 0, and the remaining Bits[5:0] = 1. This setting is the default channel index setting. The default value results in both ADC channels receiving the next write command. For more information on this function and others, see the [AN-877 Application Note, Interfacing to High Speed ADCs via SPI](#). This application note details the functions controlled by Register 0x00 to Register 0xFF. The remaining registers are documented in the [Memory Map Register Descriptions](#) section.

### Open Locations

All address and bit locations that are not included in [Table 17](#) are not currently supported for this device. Unused bits of a valid address location should be written with 0s. Writing to these locations is required only when part of an address location is open (for example, Address 0x05). If the entire address location is open or not listed in [Table 17](#) (for example, Address 0x13) this address location should not be written.

### Default Values

After the AD9257 is reset, critical registers are loaded with default values. The default values for the registers are given in [Table 17](#), the memory map register table.

**Table 17. Memory Map Register Table**

Reg. Addr. (Hex)	Register Name	Bit 7 (MSB)	Bit 6	Bit 5	Bit 4	Bit 3	Bit 2	Bit 1	Bit 0 (LSB)	Default Value (Hex)	Comments
Chip Configuration Registers											
0x00	SPI port configuration	0 = SDO active	LSB first	Soft reset	1 = 16-bit address	1 = 16-bit address	Soft reset	LSB first	0 = SDO active	0x18	The nibbles are mirrored so that LSB or MSB first mode registers correctly. The default for the ADCs is 16-bit mode.
0x01	Chip ID (global)	8-bit chip ID, Bits[7:0] AD9257 0x92 = octal 14-bit, 40 MSPS/65 MSPS serial LVDS								Read only 0x92	Unique chip ID that is used to

### Logic Levels

An explanation of logic level terminology follows:

- ▶ “Bit is set” is synonymous with “bit is set to Logic 1” or “writing Logic 1 for the bit.”
- ▶ “Clear a bit” is synonymous with “bit is set to Logic 0” or “writing Logic 0 for the bit.”

### Channel-Specific Registers

Some channel setup functions can be programmed differently for each channel. In these cases, channel address locations are internally duplicated for each channel. These registers and bits are designated in [Table 17](#) as local. These local registers and bits can be accessed by setting the appropriate data channel bits (A through H) and the clock channel DCO/FCO bits (Bits[5:4]) in Registers 0x04 and 0x05. If all the bits are set, the subsequent write affects the registers of all channels and the DCO/FCO clock channels. In a read cycle, only one of the channels should be set to read one of the four local registers. If all the bits are set during a SPI read cycle, the part returns the value for Channel A. Registers and bits designated as global in [Table 17](#) affect the entire part or the channel features for which independent settings are not allowed between channels. The settings in Register 0x04 and Register 0x05 do not affect the global registers and bits.

### MEMORY MAP REGISTER TABLE

The AD9257 uses a 3-wire interface and 16-bit addressing and, therefore, Bit 0 and Bit 7 in Register 0x00 are set to 0, and Bit 3 and Bit 4 are set to 1. When Register 0x00, Bit 5 is set high, the SPI enters a soft reset, where all of the user registers revert to their default values and Bit 2 is automatically cleared.

## MEMORY MAP

Table 17. Memory Map Register Table (Continued)

Reg. Addr. (Hex)	Register Name	Bit 7 (MSB)	Bit 6	Bit 5	Bit 4	Bit 3	Bit 2	Bit 1	Bit 0 (LSB)	Default Value (Hex)	Comments
											differentiate devices; read only.
0x02	Chip grade (global)	Open		Speed grade ID, Bits[6:4] 001 = 40 MSPS 011 = 65 MSPS	Open	Open	Open	Open	Open	Read only	Unique speed grade ID used to differentiate graded devices. Read only.
Device Index and Transfer Registers											
0x04	Device Index 2	Open	Open	Open	Open	Data Channel H	Data Channel G	Data Channel F	Data Channel E	0xF	Bits are set to determine which device on chip receives the next write command. The default is all devices on chip.
0x05	Device Index 1	Open	Open	Clock Channel DCO	Clock Channel FCO	Data Channel D	Data Channel C	Data Channel B	Data Channel A	0x3F	Bits are set to determine which device on chip receives the next write command. The default is all devices on chip.
0xFF	Transfer	Open	Open	Open	Open	Open	Open	Open	Initiate override	0x00	Set resolution/sample rate override.
Global ADC Functions											
0x08	Power modes (global)	Open	Open	External power-down pin function0 = full power-down1 = standby	Open	Open	Open	Open	Internal power-down mode 00 = chip run 01 = full power-down 10 = standby 11 = reset	0x00	Determines various generic modes of chip operation.
0x09	Clock (global)	Open	Open	Open	Open	Open	Open	Open	Duty cycle stabilize 0 = off 1 = on	0x01	Turns duty cycle stabilizer on or off.
0x0B	Clock divide(global)	Open	Open	Open	Open	Open	Clock divide ratio, Bits[2:0] 000 = divide by 1 001 = divide by 2 010 = divide by 3 011 = divide by 4 100 = divide by 5 101 = divide by 6 110 = divide by 7 111 = divide by 8		0x00	The divide ratio is the value plus 1.	
0x0C	Enhancement control	Open	Open	Open	Open	Open	Chop mode 0 = off 1 = on	Open	Open	0x00	Enables/disables chop mode.
0x0D	Test mode (local except for PN sequence resets)	User input test mode 00 = single 01 = alternate		Open	Reset PN short gen	Output test mode, Bits[3:0] (local) 0000 = off (default) 0001 = midscale short			0x00	When set, the test data is placed on the	



## MEMORY MAP

Table 17. Memory Map Register Table (Continued)

Reg. Addr. (Hex)	Register Name	Bit 7 (MSB)	Bit 6	Bit 5	Bit 4	Bit 3	Bit 2	Bit 1	Bit 0 (LSB)	Default Value (Hex)	Comments
		10 = single once 11 = alternate once (affects user input test mode only, Bits[3:0] = 1000)					0010 = positive FS 0011 = negative FS 0100 = alternating checkerboard 0101 = Open 0110 = PN 9 sequence 0111 = one/zero word toggle 1000 = user input 1001 = 1-/0-bit toggle 1010 = 1× sync 1011 = one bit high 1100 = mixed bit frequency				output pins in place of normal data.
0x10	Offset adjust (local)	8-bit device offset adjustment, Bits[7:0] (local) Offset adjust in LSBs from +127 to -128 (twos complement format)								0x00	Device offset trim.
0x14	Output mode	Open	LVDS-ANSI/ LVDS-IEEE option 0 = LVDS-ANSI1 = LVDS-IEEE reduced range link (global); (see Table 18)	Open	Open	Open	Output invert(local)	Open	Output format 0 = offset binary1 = twos complement (global)	0x01	Configures the outputs and the format of the data.
0x15	Output adjust	Open	Open	Output driver termination, Bits[1:0] 00 = none 01 = 200 Ω 10 = 100 Ω 11 = 100 Ω		Open	Open	Open	Output drive 0 = 1× drive 1 = 2× drive	0x00	Determines LVDS or other output properties.
0x16	Output phase	Open	Input clock phase adjust, Bits[6:4] (value is number of input clock cycles of phase delay) (see Table 19)			Output clock phase adjust, Bits[3:0] (Setting = 0000 through 1011) (see Table 20)				0x03	On devices that use global clock divide, determines which phase of the divider output is used to supply the output clock. Internal latching is unaffected.
0x18	V <sub>REF</sub>	Open	Open	Open	Open	Open	Internal V <sub>REF</sub> adjustment digital scheme, Bits[2:0] 000 = 1.0 V p-p 001 = 1.14 V p-p 010 = 1.33 V p-p 011 = 1.6 V p-p 100 = 2.0 V p-p		0x04	Selects and/or adjusts the V <sub>REF</sub> .	
0x19	USER_PATT1_LSB (global)	B7	B6	B5	B4	B3	B2	B1	B0	0x00	User Defined Pattern 1 LSB.
0x1A	USER_PATT1_MSB (global)	B15	B14	B13	B12	B11	B10	B9	B8	0x00	User Defined Pattern 1 MSB.
0x1B	USER_PATT2_LSB (global)	B7	B6	B5	B4	B3	B2	B1	B0	0x00	User Defined Pattern 2 LSB.
0x1C	USER_PATT2_MSB (global)	B15	B14	B13	B12	B11	B10	B9	B8	0x00	User Defined Pattern 2 MSB.

## MEMORY MAP

Table 17. Memory Map Register Table (Continued)

Reg. Addr. (Hex)	Register Name	Bit 7 (MSB)	Bit 6	Bit 5	Bit 4	Bit 3	Bit 2	Bit 1	Bit 0 (LSB)	Default Value (Hex)	Comments
0x21	Serial control (global)	LVDS output LSB first	Word-wise DDR, 1-lane, Bits[6:4] 100 = DDR 1-lane		PLL low encode rate mode	Open	Serial output number of bits 01 = 14 bits 10 = 12 bits		0x41	Serial stream control. Default causes MSB first and the native bit stream.	
0x22	Serial channel status (local)	Open	Open	Open	Open	Open	Open	Channel output reset	Channel power-down	0x00	Used to power down individual sections of a converter.
0x100	Resolution/ sample rate override	Open	Resolution/ sample-rate override enable	Resolution 01 = 14 bits 10 = 12 bits		Open	Sample rate 000 = 20 MSPS 001 = 40 MSPS 010 = 50 MSPS 011 = 65 MSPS		0x00	Resolution/ sample rate override (requires transfer bit, 0xFF).	
0x101	User I/O Control 2	Open	Open	Open	Open	Open	Open	Open	SDIO pull-down	0x00	Disables SDIO pull-down.
0x102	User I/O Control 3	Open	Open	Open	Open	VCM power-down	Open	Open	Open	0x00	VCM control.
0x109	Sync	Open	Open	Open	Open	Open	Open	Sync next only	Enable sync	0x00	

## MEMORY MAP REGISTER DESCRIPTIONS

For additional information about functions controlled in Register 0x00 to Register 0xFF, see the [AN-877 Application Note, Interfacing to High Speed ADCs via SPI](#).

## Device Index (Register 0x04 and Register 0x05)

There are certain features in the map that can be set independently for each channel, whereas other features apply globally to all channels (depending on context), regardless of which are selected. The first four bits in Register 0x04 and Register 0x05 can be used to select which individual data channels are affected. The output clock channels can be selected in Register 0x05, as well. A smaller subset of the independent feature list can be applied to those devices.

## Transfer (Register 0xFF)

All registers except Register 0x100 are updated the moment they are written. Setting Bit 0 of this transfer register high initializes the settings in the ADC sample rate override register (Address 0x100).

## Power Modes (Register 0x08)

## Bits[7:6]—Open

## Bit 5—External Power-Down Pin Function

If set, the external PDWN pin initiates standby mode. If cleared, the external PDWN pin initiates power-down mode.

## Bits[4:2]—Open

## Bits[1:0]—Internal Power-Down Mode

In normal operation (Bits[1:0] = 00), all ADC channels are active.

In power-down mode (Bits[1:0] = 01), the digital data path clocks are disabled while the digital data path is reset. Outputs are disabled.

In standby mode (Bits[1:0] = 10), the digital data path clocks and the outputs are disabled.

During a digital reset (Bits[1:0] = 11), all the digital data path clocks and the outputs (where applicable) on the chip are reset, except the SPI port. Note that the SPI is always left under control of the user, that is, it is never automatically disabled or in reset (except by power-on reset).

## Enhancement Control (Register 0x0C)

## Bits[7:3]—Open

## Bit 2—Chop Mode

For applications that are sensitive to offset voltages and other low frequency noise, such as homodyne or direct conversion receivers, chopping in the first stage of the [AD9257](#) is a feature that can be enabled by setting Bit 2. In the frequency domain, chopping translates offsets and other low frequency noise to  $f_{CLK}/2$ , where they can be filtered.

**MEMORY MAP****Bits[1:0]—Open****Output Mode (Register 0x14)****Bit 7—Open****Bit 6—LVDS-ANSI/LVDS-IEEE Option**

Setting this bit chooses the LVDS-IEEE (reduced range) option. The default setting is LVDS-ANSI. As described in Table 18, when LVDS-ANSI or LVDS-IEEE reduced range link is selected, the user can select the driver termination. The driver current is automatically selected to give the proper output swing.

**Table 18. LVDS-ANSI/LVDS-IEEE Options**

Output Mode, Bit[6]	Output Mode	Output Driver Termination	Output Driver Current
0	LVDS-ANSI	User selectable	Automatically selected to give proper swing
1	LVDS-IEEE reduced range link	User selectable	Automatically selected to give proper swing

**Bits[5:3]—Open****Bit 2—Output Invert**

Setting this bit inverts the output bit stream.

**Bit 1—Open****Bit 0—Output Format**

By default, this bit is set to send the data output in twos complement format. Resetting this bit changes the output mode to offset binary.

**Output Adjust (Register 0x15)****Bits[7:6]—Open****Bits[5:4]—Output Termination**

These bits allow the user to select the internal termination resistor.

**Bits[3:1]—Open****Bit 0—Output Drive**

Bit 0 of the output adjust register controls the drive strength on the LVDS driver of the FCO and DCO outputs only. The default values set the drive to 1 $\times$ . The drive can be increased to 2 $\times$  by setting the appropriate channel bit in Register 0x05 and then setting Bit 0. These features cannot be used with the output driver termination select. The termination selection takes precedence over the 2 $\times$  driver strength on FCO and DCO when both the output driver termination and output drive are selected.

**Output Phase (Register 0x16)****Bit 7—Open****Bits[6:4]—Input Clock Phase Adjust**

When the clock divider (Register 0x0B) is used, the applied clock is at a higher frequency than the internal sampling clock. Bits[6:4] determine at which phase of the external clock sampling occurs. This is only applicable when the clock divider is used. Selecting Bits[6:4] greater than Register 0x0B Bits[2:0] is prohibited.

**Table 19. Input Clock Phase Adjust Options**

Input Clock Phase Adjust, Bits[6:4]	Number of Input Clock Cycles of Phase Delay
000 (Default)	0
001	1
010	2
011	3
100	4
101	5
110	6
111	7

**Bits[3:0]—Output Clock Phase Adjust****Table 20. Output Clock Phase Adjust Options**

Output Clock (DCO), Phase Adjust, Bits[3:0]	DCO Phase Adjustment (Degrees Relative to $D\pm$ x Edge)
0000	0
0001	60
0010	120
0011 (Default)	180
0100	240
0101	300
0110	360
0111	420
1000	480
1001	540
1010	600
1011	660

**Resolution/Sample Rate Override (Register 0x100)**

This register is designed to allow the user to downgrade the device. Any attempt to upgrade the default speed grade results in a chip power-down. Settings in this register are not initialized until Bit 0 of the transfer register (Register 0xFF) is written high.

**MEMORY MAP****User I/O Control 2 (Register 0x101)****Bits[7:1]—Open****Bit 0—SDIO Pull-Down**

Bit 0 can be set to disable the internal 30 k $\Omega$  pull-down on the SDIO pin, which can be used to limit loading when many devices are connected to the SPI bus.

**User I/O Control 3 (Register 0x102)****Bits[7:4]—Open****Bit 3—VCM Power-Down**

Bit 3 can be set high to power down the internal VCM generator. This feature is used when applying an external reference.

**Bits[2:0]—Open**

## APPLICATIONS INFORMATION

### DESIGN GUIDELINES

Before starting design and layout of the AD9257 as a system, it is recommended that the designer become familiar with these guidelines, which describes the special circuit connections and layout requirements that are needed for certain pins.

### POWER AND GROUND RECOMMENDATIONS

When connecting power to the AD9257, it is recommended that two separate 1.8 V supplies be used. Use one supply for analog (AVDD); use a separate supply for the digital outputs (DRVDD). For both AVDD and DRVDD, several different decoupling capacitors should be used to cover both high and low frequencies. Place these capacitors close to the point of entry at the PCB level and close to the pins of the part, with minimal trace length.

A single PCB ground plane should be sufficient when using the AD9257. With proper decoupling and smart partitioning of the PCB analog, digital, and clock sections, optimum performance is easily achieved.

### CLOCK STABILITY CONSIDERATIONS

When powered on, the AD9257 goes into an initialization phase where an internal state machine sets up the biases and the registers for proper operation. During the initialization process, the AD9257 needs a stable clock. If the ADC clock source is not present or not stable during ADC power-up, it will disrupt the state machine and cause the ADC to start up in an unknown state. To correct this, an initialization sequence needs to be re-invoked after the ADC clock is stable. This is done by issuing a digital reset via Register 0x08. In the default configuration (internal  $V_{REF}$ , ac-coupled input) where  $V_{REF}$  and  $V_{CM}$  are supplied by the ADC itself, a stable clock during power-up is sufficient. In the case where  $V_{REF}$  and/or  $V_{CM}$  are supplied by an external source, these too should be stable at power up; otherwise, a subsequent digital reset via Register 0x08 will be needed. The pseudo-code sequence for a digital reset is as follows:

```
SPI_Write (0x08, 0x03); # Digital Reset
```

```
SPI_Write (0x08, 0x00); # Normal Operation
```

### EXPOSED PAD THERMAL HEAT SLUG RECOMMENDATIONS

It is required that the exposed pad on the underside of the ADC be connected to analog ground (AGND) to achieve the best electrical and thermal performance of the AD9257. An exposed continuous copper plane on the PCB should mate to the AD9257 exposed pad, Pin 0. The copper plane should have several vias to achieve the lowest possible resistive thermal path for heat dissipation to flow through the bottom of the PCB. These vias should be solder-filled or plugged.

To maximize the coverage and adhesion between the ADC and PCB, partition the continuous copper plane by overlaying a silk-screen on the PCB into several uniform sections. This provides

several tie points between the ADC and PCB during the reflow process, whereas using one continuous plane with no partitions guarantees only one tie point. For detailed information on packaging and the PCB layout of chip scale packages, see the [AN-772 Application Note, A Design and Manufacturing Guide for the Lead Frame Chip Scale Package \(LFCSP\)](#), at [www.analog.com](http://www.analog.com).

### VCM

The VCM pin should be decoupled to ground with a 0.1  $\mu$ F capacitor.

### REFERENCE DECOUPLING

The VREF pin should be externally decoupled to ground with a low ESR, 1.0  $\mu$ F capacitor in parallel with a low ESR, 0.1  $\mu$ F ceramic capacitor.

### SPI PORT

The SPI port should not be active during periods when the full dynamic performance of the converter is required. Because the SCLK, CSB, and SDIO signals are typically asynchronous to the ADC clock, noise from these signals can degrade converter performance. If the on-board SPI bus is used for other devices, it may be necessary to provide buffers between this bus and the AD9257 to keep these signals from transitioning at the converter inputs during critical sampling periods.