

FEATURES

Low offset voltage

B grade: 0.4 mV maximum (ADA4610-1/ADA4610-2 only)

A grade: 1 mV maximum

Low offset voltage drift

B grade: 2 $\mu\text{V}/^\circ\text{C}$ maximum (ADA4610-1/ADA4610-2 only)

A grade: 8 $\mu\text{V}/^\circ\text{C}$ maximum (SOIC, MSOP, LFCSP packages)

Low input bias current: 5 pA typical

Dual-supply operation: $\pm 5\text{ V}$ to $\pm 15\text{ V}$

Low voltage noise: 0.45 μV p-p at 0.1 Hz to 10 Hz

Voltage noise density: 7.30 nV/ $\sqrt{\text{Hz}}$ at f = 1 kHz

Low THD + N: 0.00025%

No phase reversal

Rail-to-rail output

Unity-gain stable

Long-term offset voltage drift (10,000 hours): 5 μV typical

Temperature hysteresis: 8 μV typical

APPLICATIONS

Instrumentation

Medical instruments

Multipole filters

Precision current measurement

Photodiode amplifiers

Sensors

Audio

GENERAL DESCRIPTION

The ADA4610-1/ADA4610-2/ADA4610-4 are precision junction field effect transistor (JFET) amplifiers that feature low input noise voltage, current noise, offset voltage, input bias current, and rail-to-rail output. The ADA4610-1 is a single amplifier, the ADA4610-2 is a dual amplifier, and the ADA4610-4 is a quad amplifier.

The combination of low offset, noise, and very low input bias current makes these amplifiers especially suitable for high impedance sensor amplification and precise current measurements using shunts. With excellent dc precision, low noise, and fast settling time, the ADA4610-1/ADA4610-2/ADA4610-4 provide superior accuracy in medical instruments, electronic measurement, and automated test equipment. Unlike many competitive amplifiers, the ADA4610-1/ADA4610-2/ADA4610-4 maintain fast settling performance with substantial capacitive loads. Unlike many older JFET amplifiers, the ADA4610-1/ADA4610-2/ADA4610-4 do not suffer from output phase reversal when input voltages exceed the maximum common-mode voltage range.

The fast slew rate and great stability with capacitive loads make the ADA4610-1/ADA4610-2/ADA4610-4 ideal for high

performance filters. Low input bias currents, low offset, and low noise result in a wide dynamic range for photodiode amplifier circuits. Low noise and distortion, high output current, and excellent speed make the ADA4610-1/ADA4610-2/ADA4610-4 great choices for audio applications.

The ADA4610-1/ADA4610-2/ADA4610-4 are specified over the -40°C to $+125^\circ\text{C}$ extended industrial temperature range.

The ADA4610-1 is available in an 8-lead SOIC package and in a 5-lead SOT-23 package. The ADA4610-2 is available in 8-lead SOIC, 8-lead MSOP, and 8-lead LFCSP packages. The ADA4610-4 is available in a 14-lead SOIC package and in a 16-lead LFCSP.

PIN CONFIGURATION

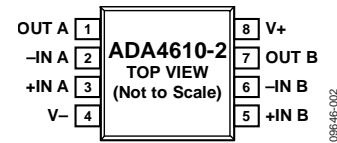

Figure 1. ADA4610-2 8-Lead SOIC (R Suffix); for Additional Packages and Models, See the Pin Configurations and Function Descriptions Section

Table 1. Related Precision JFET Operational Amplifiers

| Single | Dual | Quad |
|---------------------|----------------|----------------|
| AD8510 | AD8512 | AD8513 |
| AD8610 | AD8620 | Not applicable |
| AD820 | AD822 | AD824 |
| ADA4627-1/ADA4637-1 | Not applicable | Not applicable |
| Not applicable | ADA4001-2 | Not applicable |

Rev. I

Document Feedback

Information furnished by Analog Devices is believed to be accurate and reliable. However, no responsibility is assumed by Analog Devices for its use, nor for any infringements of patents or other rights of third parties that may result from its use. Specifications subject to change without notice. No license is granted by implication or otherwise under any patent or patent rights of Analog Devices. Trademarks and registered trademarks are the property of their respective owners.

TABLE OF CONTENTS

| | | | |
|--|----|---|----|
| Features | 1 | Comparative Voltage and Variable Voltage Graphs..... | 17 |
| Applications..... | 1 | Theory of Operation | 20 |
| Pin Configuration..... | 1 | Applications Information | 21 |
| General Description | 1 | Input Overvoltage Protection | 21 |
| Revision History | 3 | Peak Detector..... | 21 |
| Specifications..... | 4 | Current to Voltage (I to V) Conversion Applications | 21 |
| Electrical Characteristics | 5 | Comparator Operation..... | 22 |
| Absolute Maximum Ratings..... | 7 | Long-Term Drift..... | 23 |
| Thermal Resistance | 7 | Temperature Hysteresis | 23 |
| ESD Caution..... | 7 | Outline Dimensions | 24 |
| Pin Configurations and Function Descriptions | 8 | Ordering Guide | 27 |
| Typical Performance Characteristics | 11 | | |

REVISION HISTORY**6/2019—Rev. H to Rev. I**

| | |
|--|----|
| Change to Features Section..... | 1 |
| Change to Offset Voltage Drift, B Grade (ADA4610-1/ ADA4610-2) Parameter, Table 2 | 4 |
| Change to Offset Voltage Drift, B Grade (ADA4610-1/ ADA4610-2) Parameter, Table 3 | 5 |
| Replaced Figure 10 and Figure 13 | 11 |
| Change to Theory of Operation Section | 20 |

5/2017—Rev. G to Rev. H

| | |
|--|------------|
| Changed CP-8-21 to CP-8-11 | Throughout |
| Changes to Features Section | 1 |
| Changes to Figure 15 Caption, Figure 16 Caption, Figure 18 Caption, and Figure 19 Caption | 12 |
| Changed Functional Description Section to Theory of Operation Section | 20 |
| Added Long-Term Drift Section, Temperature Hysteresis Section, Figure 61, Figure 62, and Figure 63; Renumbered Sequentially | 23 |
| Updated Outline Dimensions..... | 24 |
| Changes to Ordering Guide..... | 27 |

5/2016—Rev. F to Rev. G

| | |
|--|------------|
| Changed CP-8-20 to CP-8-21 | Throughout |
| Changes to Figure 23 Caption and Figure 26 Caption | 13 |
| Updated Outline Dimensions..... | 24 |
| Changes to Ordering Guide..... | 25 |

1/2016—Rev. E to Rev. F

| | |
|---|------------|
| Added 5-Lead SOT-23 | Universal |
| Changed CP-8-9 to CP-8-20 | Throughout |
| Change to Features Section..... | 1 |
| Added Figure 3 and Table 7; Renumbered Sequentially | 8 |
| Updated Outline Dimensions..... | 23 |
| Changes to Ordering Guide..... | 25 |

4/2015—Rev. D to Rev. E

| | |
|--|-----------|
| Added ADA4610-1 | Universal |
| Added 16-Lead LFCSP_WQ..... | Universal |
| Deleted Figure 1 and Figure 3; Renumbered Sequentially | 1 |
| Changes to Features Section | 1 |
| Changes to Table 2 | 4 |
| Changes to Table 3 | 5 |
| Added Figure 2 and Table 6; Renumbered Sequentially | 7 |
| Added Figure 4 | 8 |
| Added Figure 7 | 9 |
| Changes to Table 8 | 9 |
| Changes to Figure 10 Caption and Figure 13 Caption | 10 |
| Changes to Figure 14 Caption, Figure 15, Figure 17 Caption, and Figure 18 | 11 |
| Changes to Figure 22 and Figure 25 | 12 |
| Changes to Figure 26 to Figure 31 | 13 |

| | |
|---|----|
| Changes to Figure 32 and Figure 35 | 14 |
| Changes to Figure 38 and Figure 40 | 15 |
| Changes to Figure 42 to Figure 46 | 16 |
| Changes to Figure 48, Figure 50, and Figure 53..... | 17 |
| Changes to Figure 54 and Figure 55 | 18 |
| Changes to Figure 57 and Figure 58 | 20 |
| Updated Outline Dimensions..... | 22 |
| Added Figure 64 | 23 |
| Changes to Ordering Guide..... | 24 |

11/2014—Rev. C to Rev. D

| | |
|--------------------------|----|
| Change to Figure 56..... | 19 |
|--------------------------|----|

5/2014—Rev. B to Rev. C

| | |
|--|-----------|
| Added ADA4610-4 and 14-Lead SOIC..... | Universal |
| Added Voltage Noise Density to Features Section, Figure 3, and Table 1; Renumbered Sequentially..... | 1 |
| Changes to Table 2 | 3 |
| Changes to Table 3 | 4 |
| Changes to Table 4 | 6 |
| Added Pin Configurations and Function Descriptions Section, Figure 4 to Figure 6, Table 6, and Table 7 | 7 |
| Changes to Typical Performance Characteristics Section | 8 |
| Added Functional Description Section..... | 17 |
| Added Input Overvoltage Protection Section, Peak Detector Section, I to V Conversion Applications Section, and Photodiode Circuits Section | 18 |
| Change to Figure 56..... | 18 |
| Added Figure 62, Outline Dimensions | 20 |
| Changes to Ordering Guide..... | 20 |

8/2012—Rev. A to Rev. B

| | |
|---------------------------|---|
| Changes to Figure 9 | 8 |
|---------------------------|---|

5/2012—Rev. 0 to Rev. A

| | |
|--|----|
| Changes to Data Sheet Title and General Description Section .. | 1 |
| Changed Input Impedance Parameter, Differential to Input Capacitance Parameter, and Differential Parameter, Table 1 | 3 |
| Added Input Resistance in Table 1..... | 3 |
| Changed Input Impedance, Differential Parameter to Input Capacitance, Differential Parameter, Table 2 | 4 |
| Added Input Resistance Parameter, Table 2 | 4 |
| Added Figure 9, Figure 10, and Figure 14; Renumbered Sequentially..... | 8 |
| Added Figure 15 | 9 |
| Updated Outline Dimensions..... | 16 |
| Changes to Ordering Guide..... | 17 |

12/2011—Revision 0: Initial Version

| Parameter | Symbol | Test Conditions/Comments | Min | Typ | Max | Unit |
|-----------------------------------|-----------|---|-----------------|---------|-----|------------------------|
| DYNAMIC PERFORMANCE | | | | | | |
| Slew Rate | \pm SR | $R_L = 2\text{ k}\Omega$, $A_V = 1$ | | | | |
| Rising | | | 15 ¹ | 21 | | V/ μ s |
| Falling | | | 15 ¹ | 46 | | V/ μ s |
| Gain Bandwidth Product | GBP | $V_{IN} = 5\text{ mV p-p}$, $R_L = 2\text{ k}\Omega$, $A_V = 100$ | | 15.4 | | MHz |
| Unity-Gain Crossover | UGC | $V_{IN} = 5\text{ mV p-p}$, $R_L = 2\text{ k}\Omega$, $A_V = 1$ | | 9.3 | | MHz |
| Phase Margin | ϕ_M | | | 61 | | Degrees |
| –3 dB Closed-Loop Bandwidth | –3 dB | $A_V = 1$, $V_{IN} = 5\text{ mV p-p}$ | | 10.6 | | MHz |
| Total Harmonic Distortion + Noise | THD + N | 1 kHz, $A_V = 1$, $R_L = 2\text{ k}\Omega$, $V_{IN} = 1\text{ V rms}$ | | 0.00025 | | % |
| NOISE PERFORMANCE | | | | | | |
| Voltage Noise | e_n p-p | 0.1 Hz to 10 Hz | | 0.45 | | μ V p-p |
| Voltage Noise Density | e_n | f = 10 Hz | | 14 | | nV/ $\sqrt{\text{Hz}}$ |
| | | f = 100 Hz | | 8.20 | | nV/ $\sqrt{\text{Hz}}$ |
| | | f = 1 kHz | | 7.30 | | nV/ $\sqrt{\text{Hz}}$ |
| | | f = 10 kHz | | 7.30 | | nV/ $\sqrt{\text{Hz}}$ |

¹ Guaranteed by design and characterization.

ELECTRICAL CHARACTERISTICS

$V_{SY} = \pm 15\text{ V}$, $V_{CM} = 0\text{ V}$, $T_A = 25^\circ\text{C}$, unless otherwise noted.

Table 3.

| Parameter | Symbol | Test Conditions/Comments | Min | Typ | Max | Unit |
|--|--------------------------|--|-------|------------|-------|------------------------------|
| INPUT CHARACTERISTICS | | | | | | |
| Offset Voltage | V_{OS} | | | | | |
| B Grade (ADA4610-1/ADA4610-2) | | $-40^\circ\text{C} < T_A < +125^\circ\text{C}$ | | 0.2 | 0.4 | mV |
| A Grade | | $-40^\circ\text{C} < T_A < +125^\circ\text{C}$ | | 0.4 | 1 | mV |
| Offset Voltage Drift | $\Delta V_{OS}/\Delta T$ | | | | | |
| B Grade (ADA4610-1/ADA4610-2) ¹ | | $-40^\circ\text{C} < T_A < +125^\circ\text{C}$ | | 0.5 | 2 | $\mu\text{V}/^\circ\text{C}$ |
| A Grade ¹ (SOIC, MSOP, LFCSP) | | $-40^\circ\text{C} < T_A < +125^\circ\text{C}$ | | 1 | 8 | $\mu\text{V}/^\circ\text{C}$ |
| A Grade ¹ (SOT-23) | | $-40^\circ\text{C} < T_A < +125^\circ\text{C}$ | | 1 | 12 | $\mu\text{V}/^\circ\text{C}$ |
| Input Bias Current | I_B | | | | | |
| | | $-40^\circ\text{C} < T_A < +125^\circ\text{C}$ | | 5 | 25 | pA |
| Input Offset Current | I_{OS} | | | | | |
| | | $-40^\circ\text{C} < T_A < +125^\circ\text{C}$ | | 2 | 20 | pA |
| Input Voltage Range | | | –12.5 | | +12.5 | V |
| Common-Mode Rejection Ratio | CMRR | $V_{CM} = -12.5\text{ V to }+12.5\text{ V}$ | 100 | 115 | | dB |
| | | $-40^\circ\text{C} < T_A < +125^\circ\text{C}$ | 96 | | | dB |
| Large Signal Voltage Gain | A_{VO} | $R_L = 2\text{ k}\Omega$, $V_{OUT} = \pm 13.5\text{ V}$ | | | | |
| ADA4610-2 | | $-40^\circ\text{C} < T_A < +125^\circ\text{C}$ | 104 | 107 | | dB |
| ADA4610-1/ADA4610-4 | | $-40^\circ\text{C} < T_A < +125^\circ\text{C}$ | 91 | | | dB |
| | | $-40^\circ\text{C} < T_A < +125^\circ\text{C}$ | 102 | 104 | | dB |
| | | $-40^\circ\text{C} < T_A < +125^\circ\text{C}$ | 86 | | | dB |
| Input Capacitance | | $V_{CM} = 0\text{ V}$ | | | | |
| Differential | | | | 3.1 | | pF |
| Common-Mode | | | | 4.8 | | pF |
| Input Resistance | | $V_{CM} = 0\text{ V}$ | | $>10^{13}$ | | Ω |

| Parameter | Symbol | Test Conditions/Comments | Min | Typ | Max | Unit |
|--|--------------------|---|-----------------|---------|-------------|----------|
| OUTPUT CHARACTERISTICS | | | | | | |
| Output Voltage High | V _{OH} | R _L = 2 kΩ | 14.80 | 14.90 | | V |
| | | -40°C < T _A < +125°C | 14.65 | | | V |
| | | R _L = 600 Ω | 14.25 | 14.47 | | V |
| | | -40°C < T _A < +125°C | 13.35 | | | V |
| Output Voltage Low | V _{OL} | R _L = 2 kΩ | | -14.90 | -14.85 | V |
| | | -40°C < T _A < +125°C | | | -14.75 | V |
| | | R _L = 600 Ω | | -14.68 | -14.60 | V |
| | | -40°C < T _A < +125°C | | | -14.30 | V |
| Short-Circuit Current | I _{SC} | | ±79 | | | mA |
| POWER SUPPLY | | | | | | |
| Power Supply Rejection Ratio ADA4610-2 ADA4610-1/ADA4610-4 | PSRR | V _{SY} = ±4.5 V to ±18 V | 106 | 125 | | dB |
| | | -40°C < T _A < +125°C | 103 | | | dB |
| | | -40°C < T _A < +125°C | 104 | 117 | | dB |
| | | -40°C < T _A < +125°C | 100 | | | dB |
| Supply Current per Amplifier | I _{SY} | I _{OUT} = 0 mA -40°C < T _A < +125°C | | 1.60 | 1.85 2.0 | mA mA |
| DYNAMIC PERFORMANCE | | | | | | |
| Slew Rate | ±SR | R _L = 2 kΩ, A _v = +1 | 17 ¹ | 25 | | V/μs |
| | | | | 61 | | V/μs |
| Gain Bandwidth Product | GBP | V _{IN} = 5 mV p-p, R _L = 2 kΩ, A _v = 100 | | 16.3 | | MHz |
| Unity-Gain Crossover | UGC | V _{IN} = 5 mV p-p, R _L = 2 kΩ, A _v = 1 | | 9.3 | | MHz |
| Phase Margin | φ _M | | | 66 | | Degrees |
| -3 dB Closed-Loop Bandwidth | -3 dB | A _v = 1, V _{IN} = 5 mV p-p | | 9.5 | | MHz |
| Total Harmonic Distortion + Noise | THD + N | 1 kHz, A _v = 1, R _L = 2 kΩ, V _{IN} = 5 V rms | | 0.00025 | | % |
| NOISE PERFORMANCE | | | | | | |
| Peak-to-Peak Voltage Noise | e _n p-p | 0.1 Hz to 10 Hz bandwidth | | 0.45 | | μV p-p |
| Voltage Noise Density | e _n | f = 10 Hz | | 14 | | nV/√Hz |
| | | f = 100 Hz | | 8.50 | | nV/√Hz |
| | | f = 1 kHz | | 7.30 | | nV/√Hz |
| | | f = 10 kHz | | 7.30 | | nV/√Hz |

¹ Guaranteed by design and characterization.

ABSOLUTE MAXIMUM RATINGS

Table 4.

| Parameter | Rating |
|--|---|
| Supply Voltage | ± 18 V |
| Input Voltage | $\pm V_S$ |
| Input Current ¹ | ± 10 mA |
| Storage Temperature Range | -65°C to $+150^\circ\text{C}$ |
| Operating Temperature Range | -40°C to $+125^\circ\text{C}$ |
| Junction Temperature Range | -65°C to $+150^\circ\text{C}$ |
| Lead Temperature (Soldering, 10 sec) | 300°C |
| Electrostatic Discharge (ESD) | |
| Human Body Model (HBM) ² | 2500 V |
| Field Induced Charge Device Model (FICDM) ³ | 1250 V |

¹ The input pins have clamp diodes connected to the power supply pins. Limit the input current to 10 mA or less whenever input signals exceed the power supply rail by 0.3 V.

² ESDA/JEDEC JS-001-2011 applicable standard.

³ JESD22-C101 (ESD FICDM standard of JEDEC) applicable standard.

Stresses at or above those listed under Absolute Maximum Ratings may cause permanent damage to the product. This is a stress rating only; functional operation of the product at these or any other conditions above those indicated in the operational section of this specification is not implied. Operation beyond the maximum operating conditions for extended periods may affect product reliability.

THERMAL RESISTANCE

Table 5. Thermal Resistance

| Package Type | θ_{JA} ¹ | θ_{JC} | Unit |
|---------------|----------------------------|---------------|---------------------------|
| 5-Lead SOT-23 | 219.4 | 155.6 | $^\circ\text{C}/\text{W}$ |
| 8-Lead SOIC | 120 | 43 | $^\circ\text{C}/\text{W}$ |
| 8-Lead LFCSP | 57 | 12 | $^\circ\text{C}/\text{W}$ |
| 8-Lead MSOP | 142 | 45 | $^\circ\text{C}/\text{W}$ |
| 14-Lead SOIC | 115 | 36 | $^\circ\text{C}/\text{W}$ |
| 16-Lead LFCSP | 65 | 3.2 | $^\circ\text{C}/\text{W}$ |

¹ θ_{JA} is specified for worst-case conditions, that is, θ_{JA} is specified for a device soldered in a circuit board for surface-mount packages.

ESD CAUTION



ESD (electrostatic discharge) sensitive device. Charged devices and circuit boards can discharge without detection. Although this product features patented or proprietary protection circuitry, damage may occur on devices subjected to high energy ESD. Therefore, proper ESD precautions should be taken to avoid performance degradation or loss of functionality.

PIN CONFIGURATIONS AND FUNCTION DESCRIPTIONS

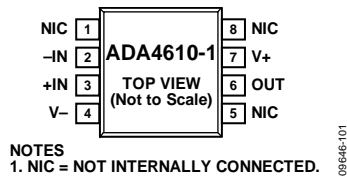

Figure 2. ADA4610-1 Pin Configuration, 8-Lead SOIC (R Suffix)

Table 6. ADA4610-1 Pin Function Descriptions, 8-Lead SOIC

| Pin No. | Mnemonic | Description |
|---------|----------|---------------------------|
| 1, 5, 8 | NIC | Not Internally Connected. |
| 2 | -IN | Inverting Input. |
| 3 | +IN | Noninverting Input. |
| 4 | V- | Negative Supply Voltage. |
| 6 | OUT | Output. |
| 7 | V+ | Positive Supply Voltage. |

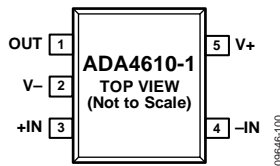

Figure 3. ADA4610-1 Pin Configuration, 5-Lead SOT-23 (RJ Suffix)

Table 7. ADA4610-1 Pin Function Descriptions, 5-Lead SOT-23

| Pin No. | Mnemonic | Description |
|---------|----------|--------------------------|
| 1 | OUT | Output. |
| 2 | V- | Negative Supply Voltage. |
| 3 | +IN | Noninverting Input. |
| 4 | -IN | Inverting Input. |
| 5 | V+ | Positive Supply Voltage. |

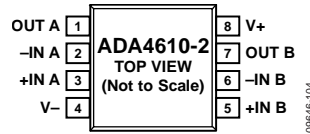

Figure 4. ADA4610-2 Pin Configuration, 8-Lead SOIC (R Suffix)



Figure 5. ADA4610-2 Pin Configuration, 8-Lead MSOP (RM Suffix)

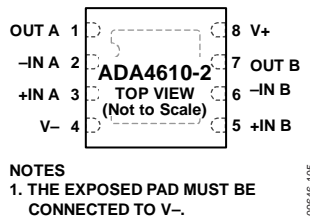

Figure 6. ADA4610-2 Pin Configuration, 8-Lead LFCSP (CP Suffix)

Table 8. ADA4610-2 Pin Function Descriptions, 8-Lead SOIC, 8-Lead MSOP, and 8-Lead LFCSP

| Pin No. | Mnemonic | Description |
|---------|----------|--|
| 1 | OUT A | Output Channel A. |
| 2 | -IN A | Inverting Input Channel A. |
| 3 | +IN A | Noninverting Input Channel A. |
| 4 | V- | Negative Supply Voltage. |
| 5 | +IN B | Noninverting Input Channel B. |
| 6 | -IN B | Inverting Input Channel B. |
| 7 | OUT B | Output Channel B. |
| 8 | V+ | Positive Supply Voltage. |
| | EPAD | Exposed Pad for the 8-Lead LFCSP (CP Suffix). The exposed pad must be connected to V-. |

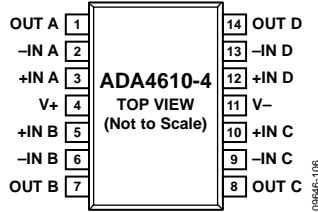
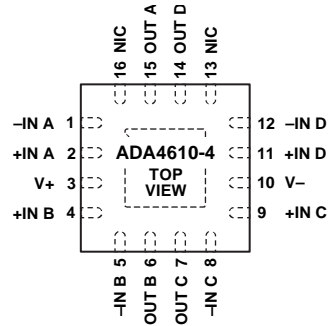

Figure 7. ADA4610-4 Pin Configuration, 14-Lead SOIC (R Suffix)



NOTES
 1. NIC = NOT INTERNALLY CONNECTED.
 2. THE EXPOSED PAD MUST BE CONNECTED TO V-.

Figure 8. ADA4610-4 Pin Configuration, 16-Lead LFCSP (CP Suffix)

Table 9. ADA4610-4 Pin Function Descriptions, 14-Lead SOIC and 16-Lead LFCSP

| Pin No. | | Mnemonic | Description |
|----------------|---------------|----------|---|
| 14-Lead SOIC | 16-Lead LFCSP | | |
| 1 | 15 | OUT A | Output Channel A. |
| 2 | 1 | -IN A | Inverting Input Channel A. |
| 3 | 2 | +IN A | Noninverting Input Channel A. |
| 4 | 3 | V+ | Positive Supply Voltage. |
| 5 | 4 | +IN B | Noninverting Input Channel B. |
| 6 | 5 | -IN B | Inverting Input Channel B. |
| 7 | 6 | OUT B | Output Channel B. |
| 8 | 7 | OUT C | Output Channel C. |
| 9 | 8 | -IN C | Inverting Input Channel C. |
| 10 | 9 | +IN C | Noninverting Input Channel C. |
| 11 | 10 | V- | Negative Supply Voltage. |
| 12 | 11 | +IN D | Noninverting Input Channel D. |
| 13 | 12 | -IN D | Inverting Input Channel D. |
| 14 | 14 | OUT D | Output Channel D. |
| Not applicable | 13, 16 | NIC | Not Internally Connected. |
| Not applicable | | EPAD | Exposed Pad. The exposed pad must be connected to V-. |

TYPICAL PERFORMANCE CHARACTERISTICS

T_A = 25°C, unless otherwise noted.

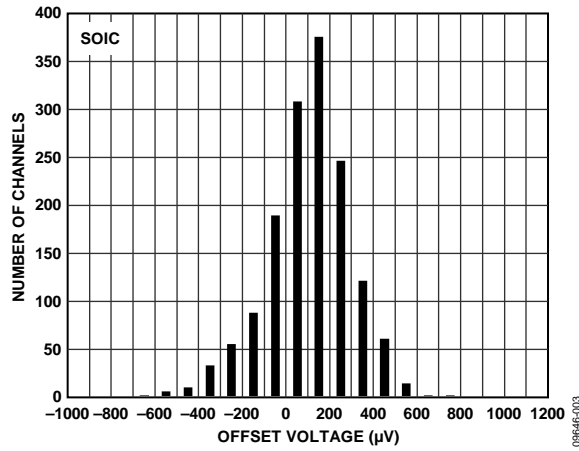

Figure 9. Input Offset Voltage Distribution, V_{SY} = ±5 V

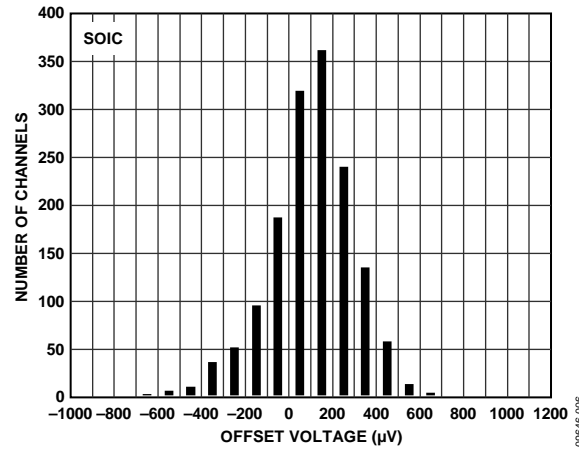

Figure 12. Input Offset Voltage Distribution, V_{SY} = ±15 V

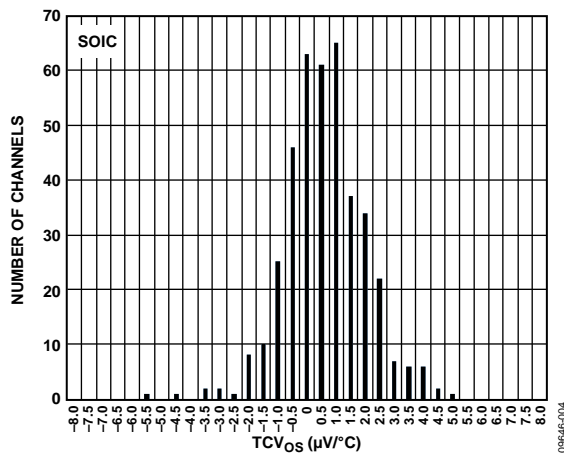

Figure 10. Input Offset Voltage Drift (TCV_{OS}) Distribution, V_{SY} = ±5 V

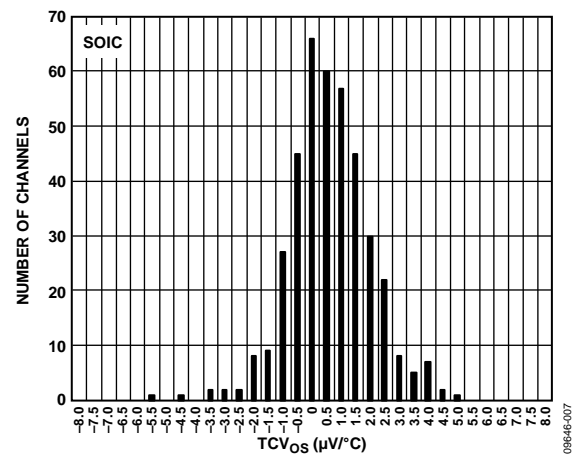

Figure 13. TCV_{OS} Distribution, V_{SY} = ±15 V

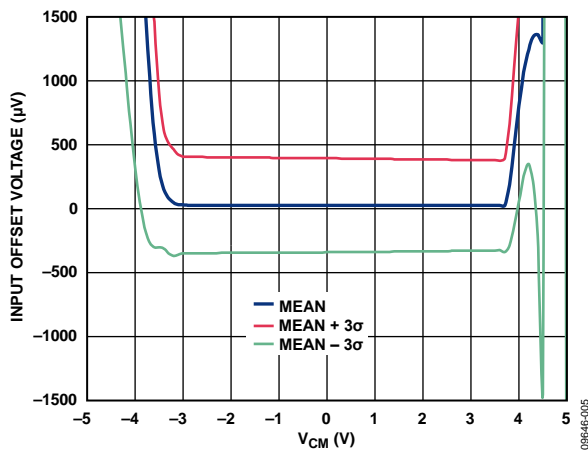

Figure 11. Input Offset Voltage vs. Common-Mode Input Voltage (V_{CM}), V_{SY} = ±5 V, R_L = ∞

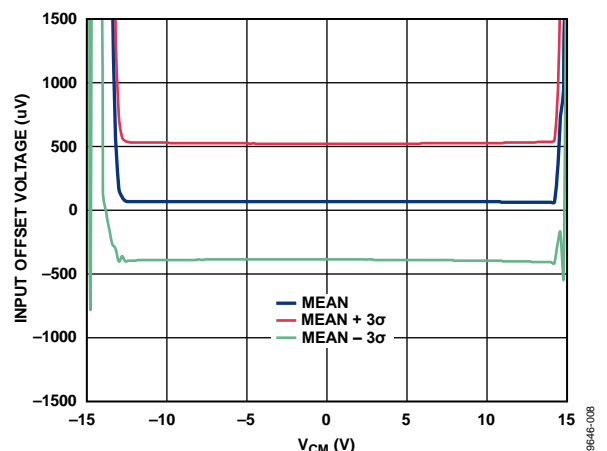

Figure 14. Input Offset Voltage vs. Input Common-Mode Voltage (V_{CM}), V_{SY} = ±15 V, R_L = ∞

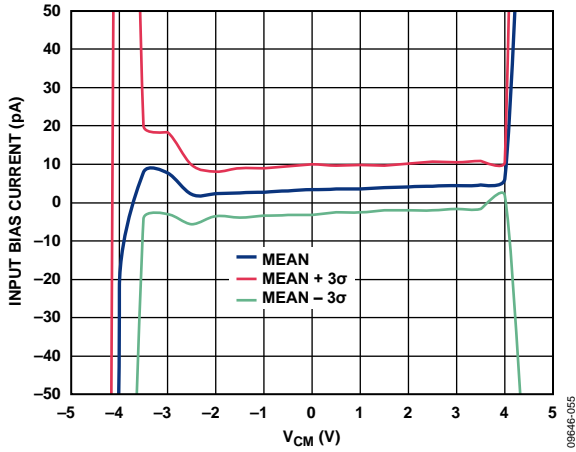

Figure 15. Input Bias Current vs. Common-Mode Input Voltage (V_{CM}), Mean and Three Standard Deviations, $V_{SV} = \pm 5 V, R_L = \infty$

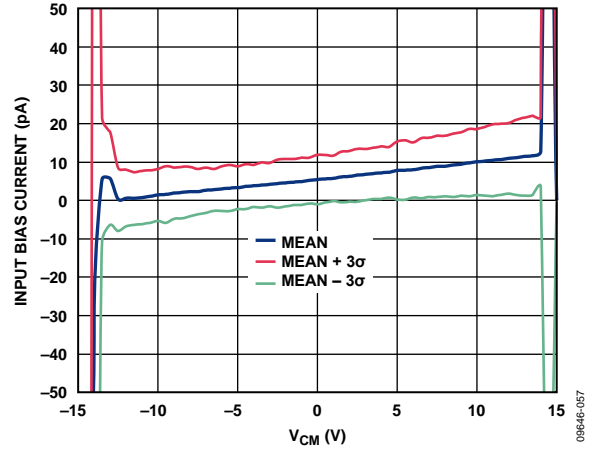

Figure 18. Input Bias Current vs. Common-Mode Input Voltage (V_{CM}), Mean and Three Standard Deviations, $V_{SV} = \pm 15 V, R_L = \infty$

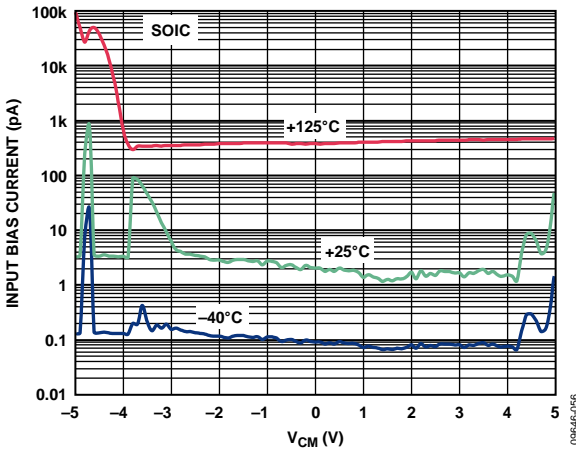

Figure 16. Input Bias Current vs. Common-Mode Input Voltage (V_{CM}), Three Temperatures, $V_{SV} = \pm 5 V, R_L = \infty$

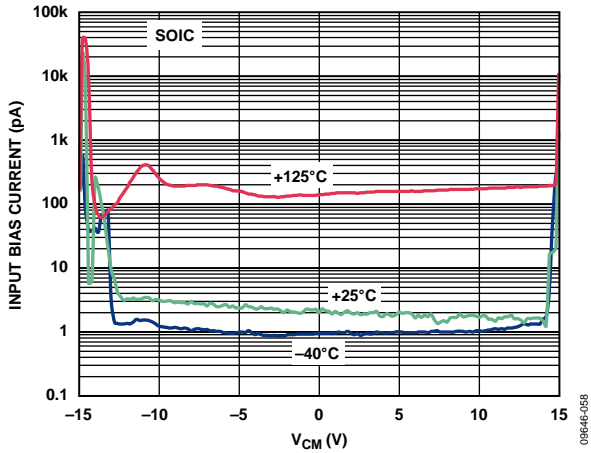

Figure 19. Input Bias Current vs. Common-Mode Input Voltage (V_{CM}), Three Temperatures, $V_{SV} = \pm 15 V, R_L = \infty$

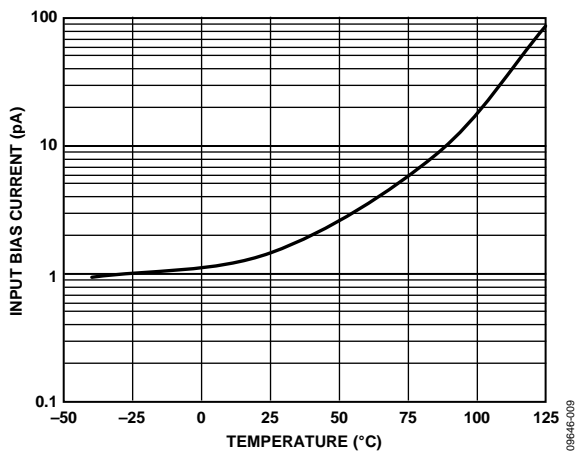

Figure 17. Input Bias Current vs. Temperature, $V_{SV} = \pm 5 V$

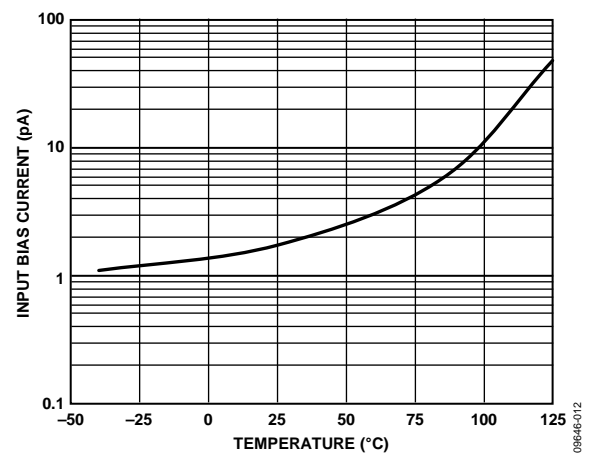

Figure 20. Input Bias Current vs. Temperature, $V_{SV} = \pm 15 V$

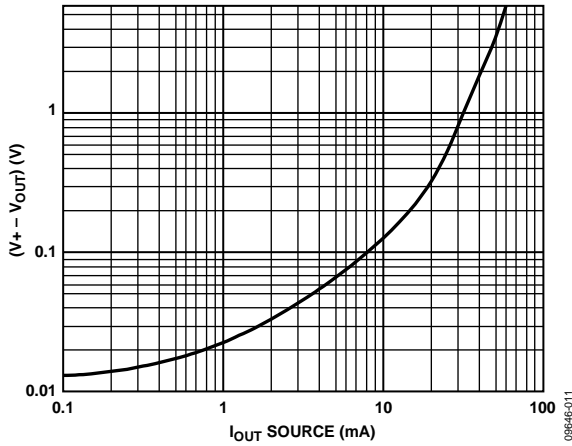

Figure 21. Dropout Voltage ($V+ - V_{out}$) vs. I_{out} Source, $V_{SY} = \pm 5 V$

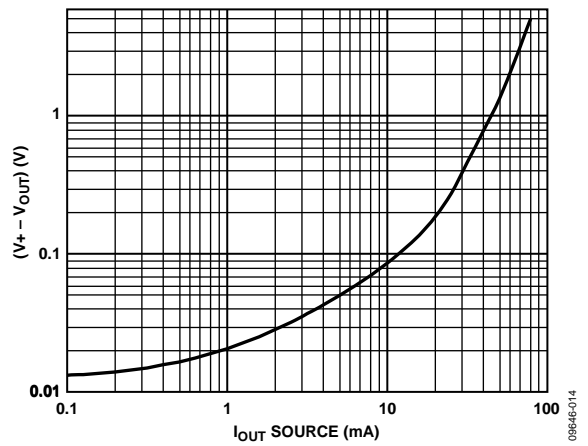

Figure 24. Dropout Voltage ($V+ - V_{out}$) vs. I_{out} Source, $V_{SY} = \pm 15 V$

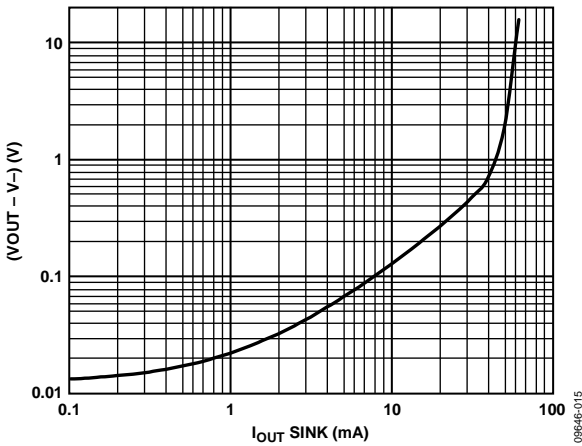

Figure 22. Dropout Voltage ($V_{out} - V-$) vs. I_{out} Sink, $V_{SY} = \pm 5 V$

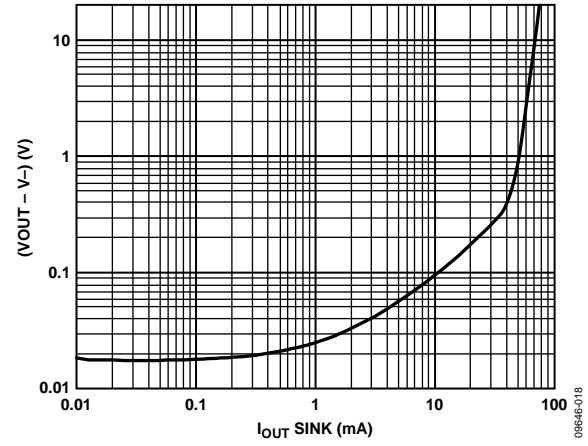

Figure 25. Dropout Voltage ($V_{out} - V-$) vs. I_{out} Sink, $V_{SY} = \pm 15 V$

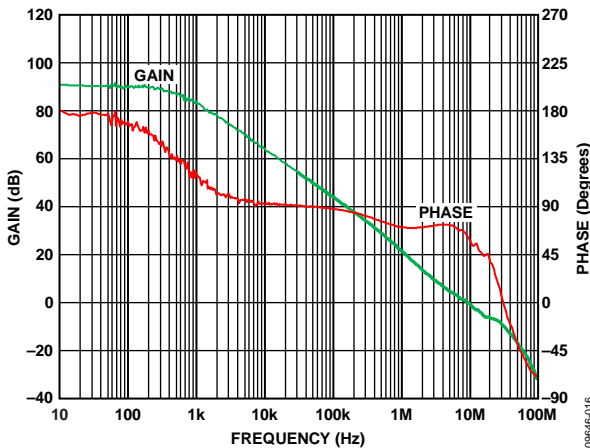

Figure 23. Open-Loop Gain and Phase Margin vs. Frequency, $V_{SY} = \pm 5 V$, $R_L = 2 k\Omega$, $V_{IN} = 5 mV$

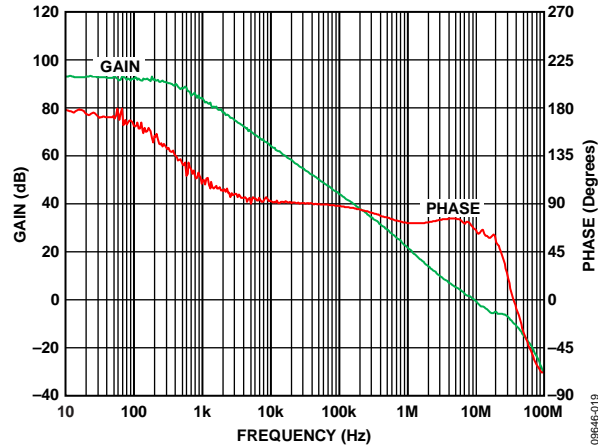

Figure 26. Open-Loop Gain and Phase Margin vs. Frequency, $V_{SY} = \pm 15 V$, $R_L = 2 k\Omega$, $V_{IN} = 5 mV$

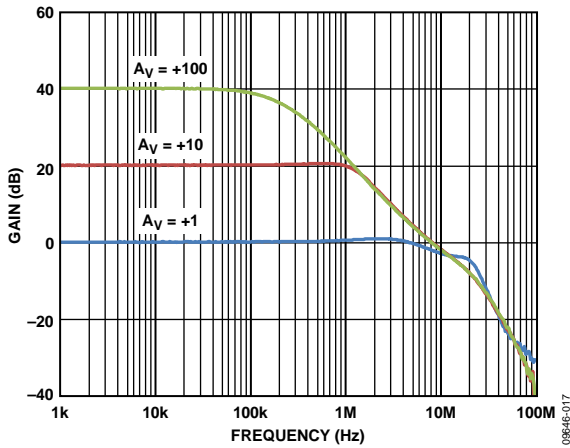

Figure 27. Closed-Loop Gain vs. Frequency, $V_{SV} = \pm 5 V$

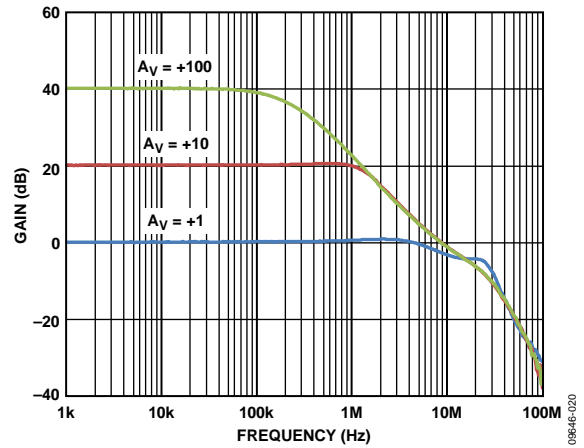

Figure 30. Closed-Loop Gain vs. Frequency, $V_{SV} = \pm 15 V$

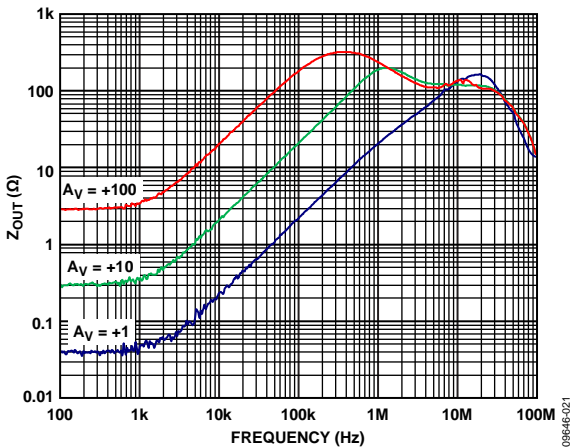

Figure 28. Closed-Loop Output Impedance (Z_{OUT}) vs. Frequency, $V_{SV} = \pm 5 V$

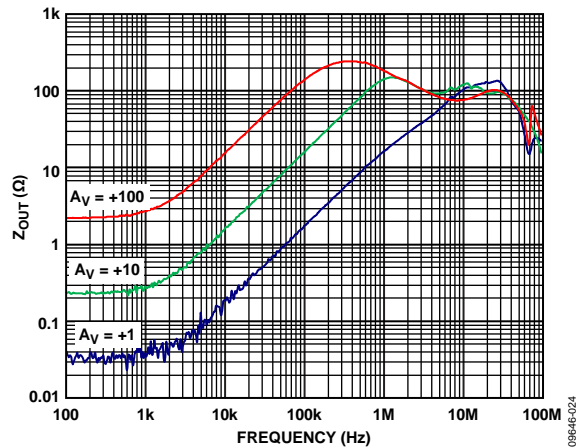

Figure 31. Closed-Loop Output Impedance (Z_{OUT}) vs. Frequency, $V_{SV} = \pm 15 V$

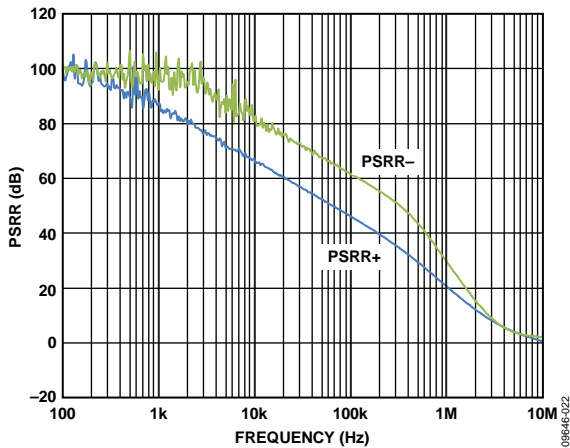

Figure 29. PSRR vs. Frequency, $V_{SV} = \pm 5 V$

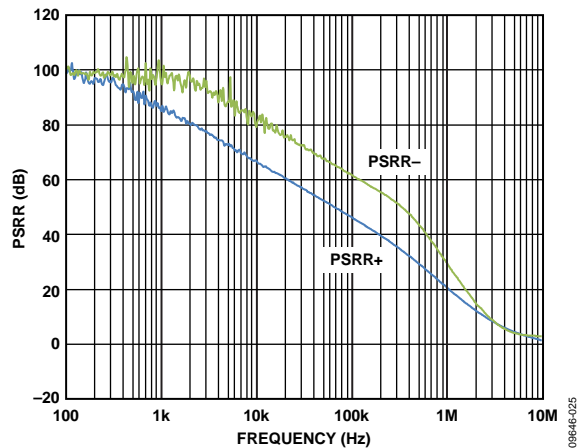

Figure 32. PSRR vs. Frequency, $V_{SV} = \pm 15 V$

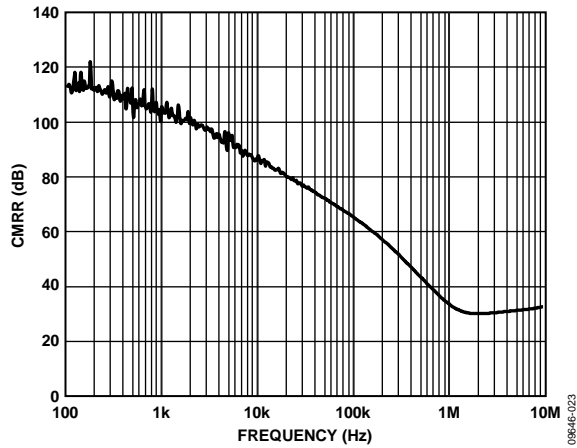

Figure 33. CMRR vs. Frequency, $V_{SY} = \pm 5 V$

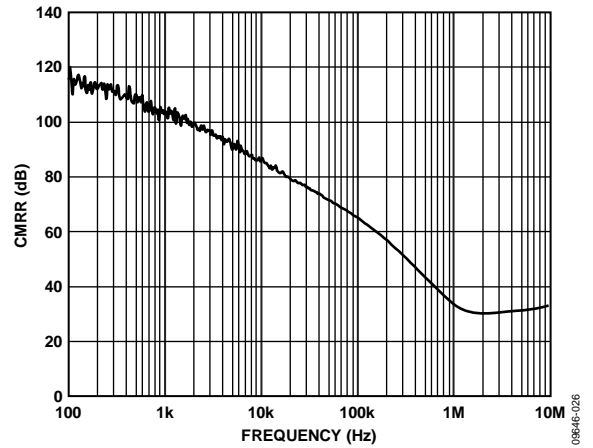

Figure 36. CMRR vs. Frequency, $V_{SY} = \pm 15 V$

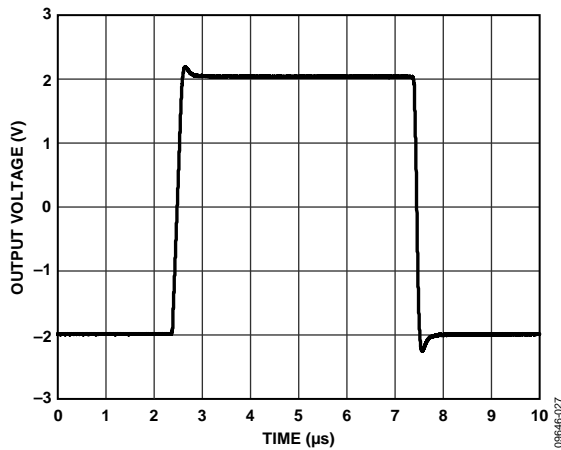

Figure 34. Large Signal Transient Response, $V_{SY} = \pm 5 V$, $A_v = 1$, $R_L = 2 k\Omega$, $C_L = 100 pF$

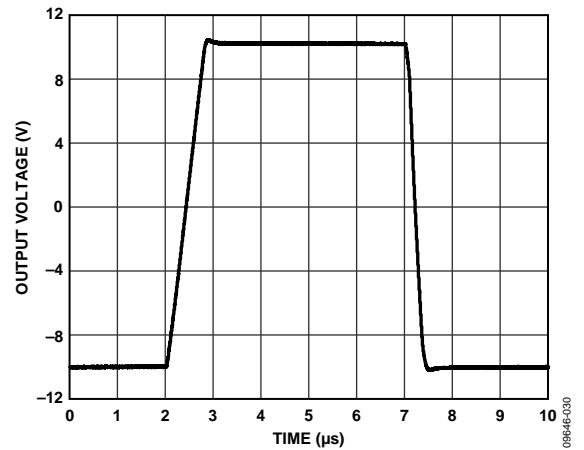

Figure 37. Large Signal Transient Response, $V_{SY} = \pm 15 V$, $A_v = 1$, $R_L = 2 k\Omega$, $C_L = 100 pF$

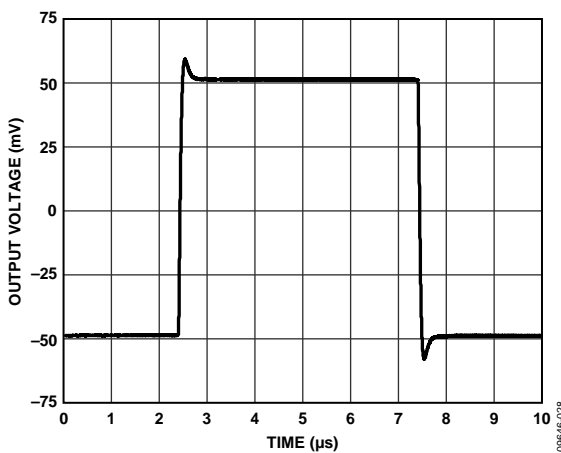

Figure 35. Small Signal Transient Response, $V_{SY} = \pm 5 V$, $A_v = 1$, $R_L = 2 k\Omega$, $C_L = 100 pF$

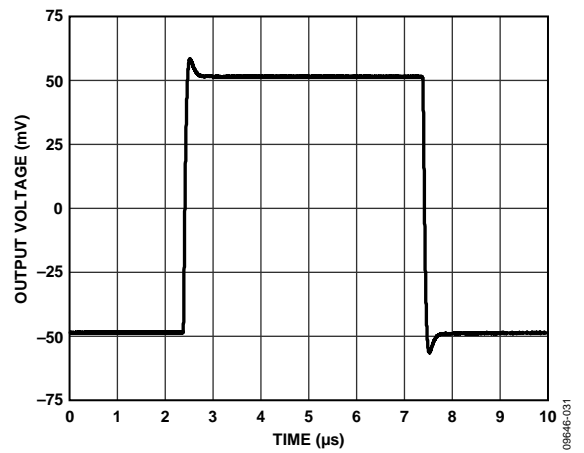

Figure 38. Small Signal Transient Response, $V_{SY} = \pm 15 V$, $A_v = 1$, $R_L = 2 k\Omega$, $C_L = 100 pF$

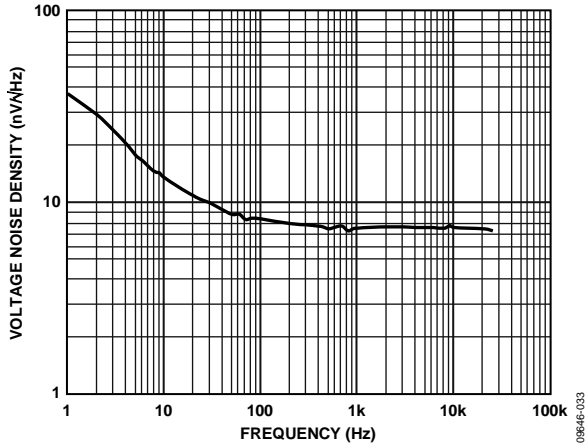

Figure 39. Voltage Noise Density vs. Frequency, $V_{SY} = \pm 5 V$

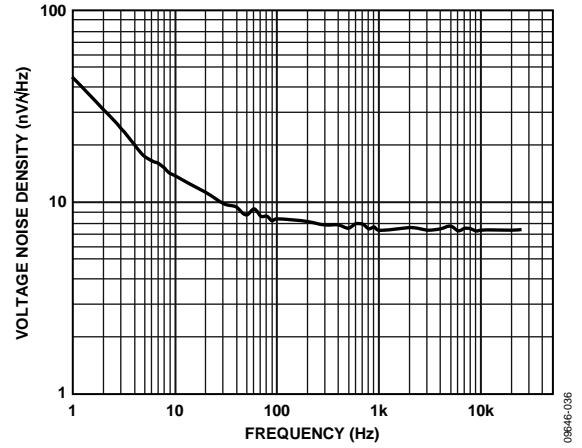

Figure 41. Voltage Noise Density vs. Frequency, $V_{SY} = \pm 15 V$

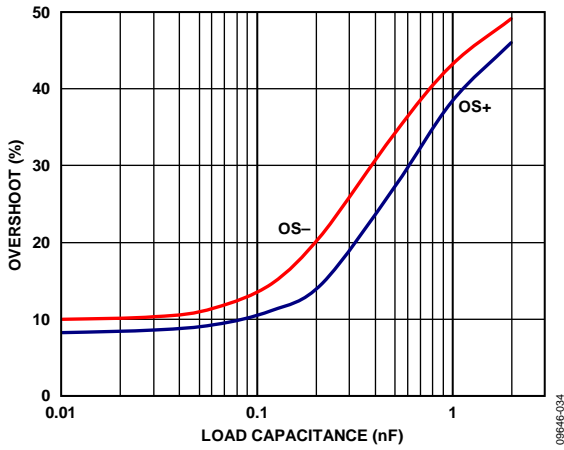

Figure 40. Overshoot vs. Load Capacitance, $V_{SY} = \pm 5 V$, $A_V = 1$, $R_L = 2 k\Omega$, $V_{IN} = 100 mV p-p$

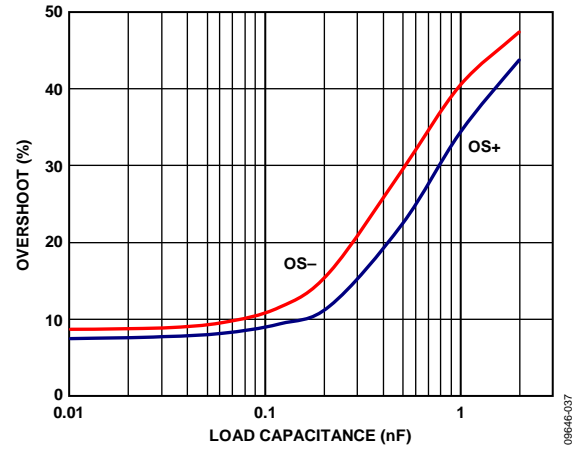

Figure 42. Overshoot vs. Load Capacitance, $V_{SY} = \pm 15 V$, $A_V = 1$, $R_L = 2 k\Omega$, $V_{IN} = 100 mV p-p$

COMPARATIVE VOLTAGE AND VARIABLE VOLTAGE GRAPHS

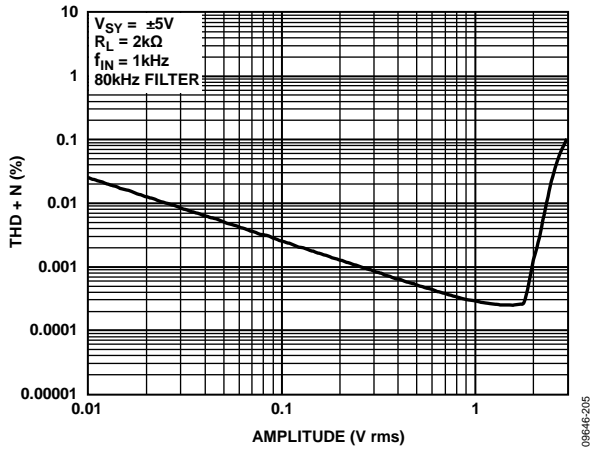

Figure 43. THD + N vs. Amplitude, $V_{SY} = \pm 5V$

09646-205

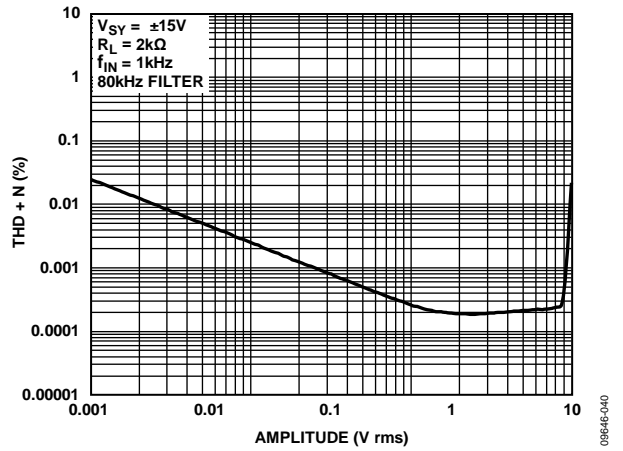

Figure 46. THD + N vs. Amplitude, $V_{SY} = \pm 15V$

09646-040

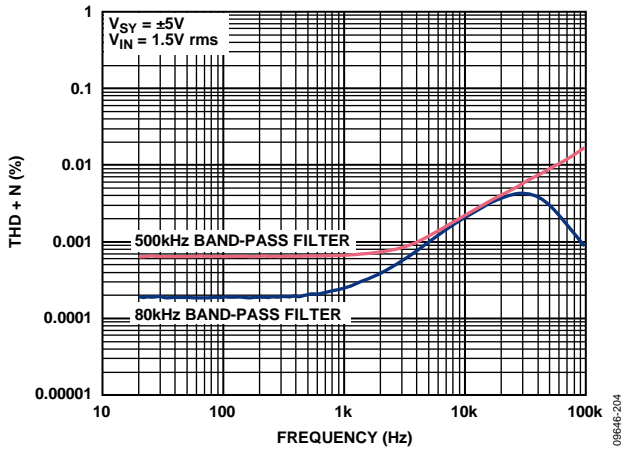

Figure 44. THD + N vs. Frequency, $V_{SY} = \pm 5V$

09646-204

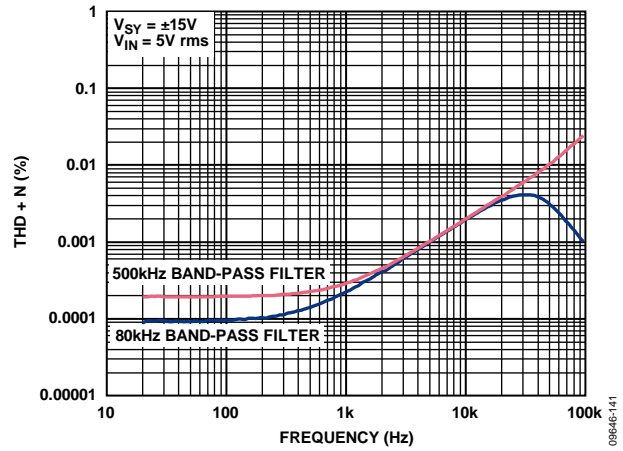

Figure 47. THD + N vs. Frequency, $V_{SY} = \pm 15V$

09646-141

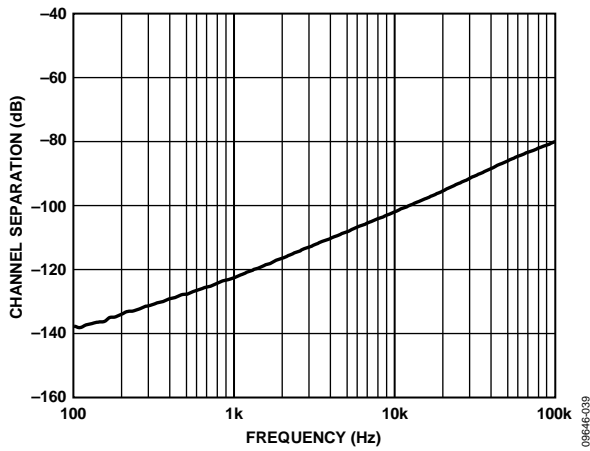

Figure 45. Channel Separation vs. Frequency

09646-039

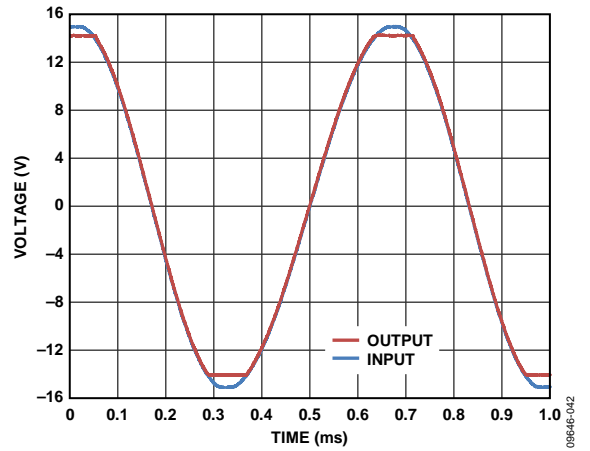

Figure 48. No Phase Reversal, $V_{SY} = \pm 15V$, $A_V = +1$, $R_L = 2k\Omega$, $C_L = 100pF$

09646-042

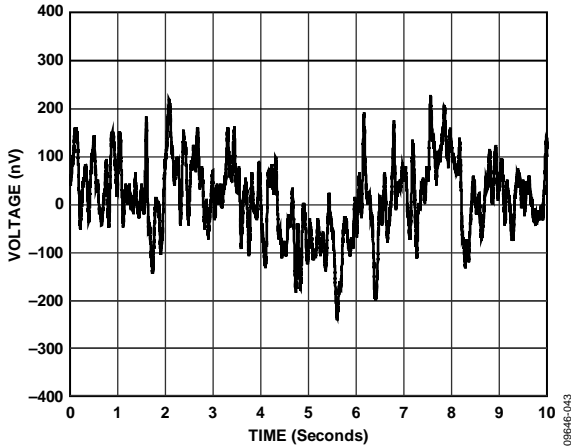

Figure 49. Voltage Noise, 0.1 Hz to 10 Hz

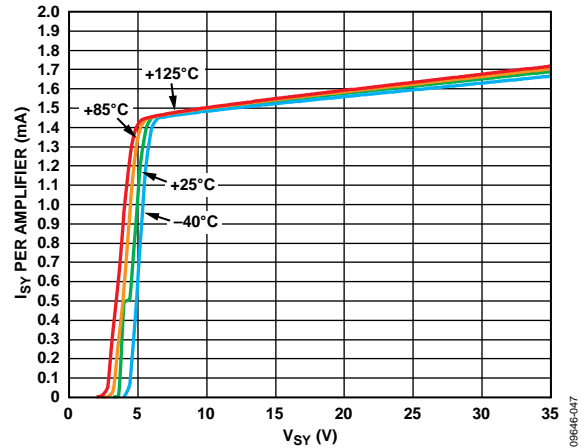

Figure 52. Supply Current (I_{SV}) per Amplifier vs. Supply Voltage (V_{SV}) at Various Temperatures

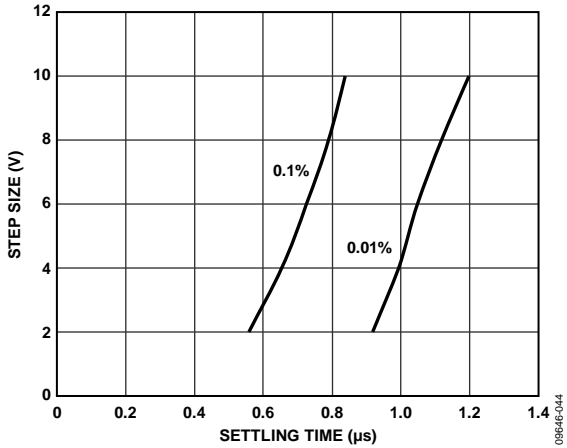

Figure 50. Positive Step Settling Time

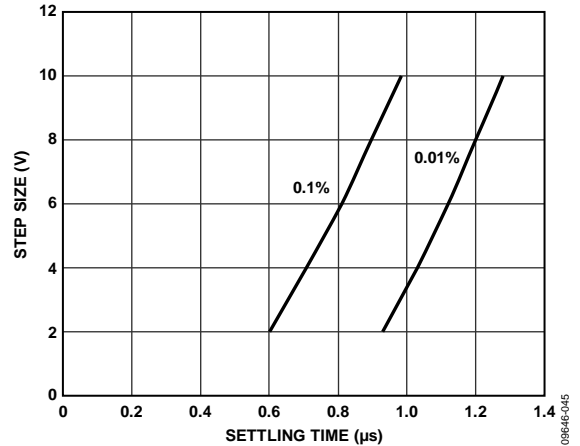

Figure 53. Negative Step Settling Time

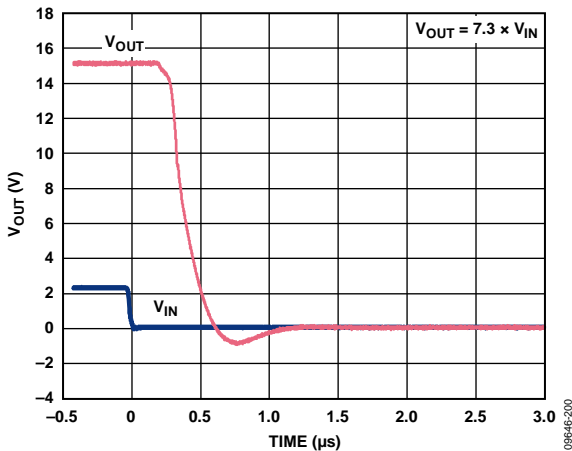

Figure 51. Positive Overload Recovery

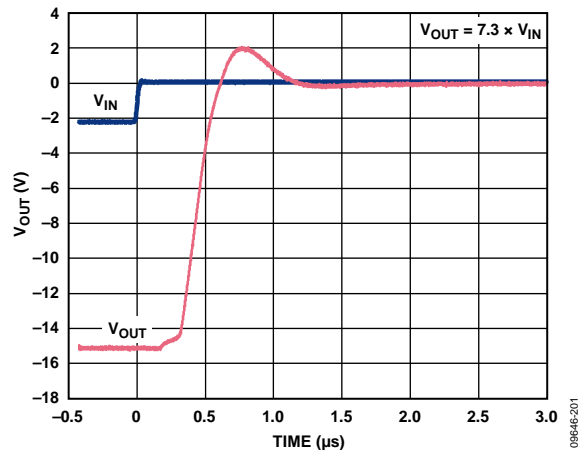

Figure 54. Negative Overload Recovery

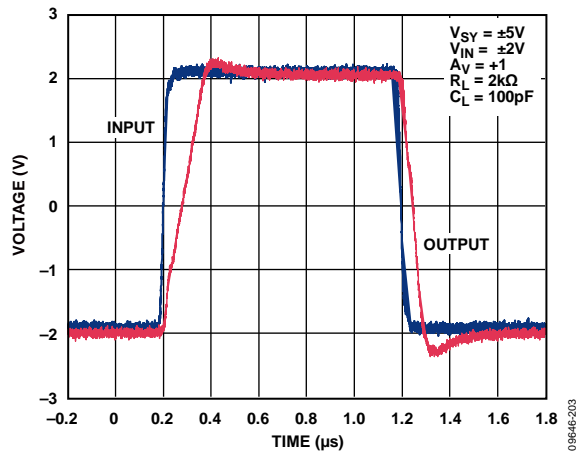

Figure 55. Positive and Negative Slew Rate ($V_{SY} = \pm 5V$, $A_V = 1$, $R_L = 2k\Omega$)

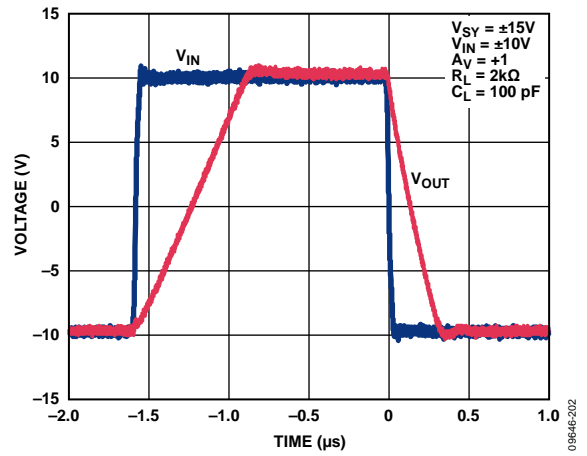

Figure 56. Positive and Negative Slew Rate ($V_{SY} = \pm 15V$, $A_V = 1$, $R_L = 2k\Omega$)

THEORY OF OPERATION

The ADA4610-1/ADA4610-2/ADA4610-4 are manufactured using the Analog Devices, Inc., *iPolar*® process, a 36 V dielectrically isolated (DI) process with P-channel JFET technology. The unique architecture of the ADA4610-1/ADA4610-2/ADA4610-4 makes it possible to combine high precision and high speed characteristics into a high voltage, low power op amp. A simplified schematic for the ADA4610-1/ADA4610-2/ADA4610-4 is shown in Figure 57. The JFET input stage architecture offers advantages of low input bias current, high bandwidth, high gain, low noise, and no phase reversal when the applied input signal exceeds the common-mode voltage range. The output stage is rail-to-rail with high drive characteristics and low dropout voltage for both sinking and sourcing currents.

The ADA4610-1/ADA4610-2/ADA4610-4 are unconditionally stable for all gain configurations, even with capacitive loads well in excess of 1 nF. The devices have internal protective circuitry that allows voltages as high as 0.3 V beyond the supplies to be applied at the input of either terminal without causing damage (for higher input voltages, refer to the Input Overvoltage Protection section).

The ADA4610-1/ADA4610-2 B grades achieve less than 0.4 mV of offset and 2 $\mu\text{V}/^\circ\text{C}$ of offset drift; these characteristics are usually associated with very high precision bipolar input amplifiers. The gate current of a typical JFET doubles every 10°C, resulting in a similar increase in input bias current over temperature. The low power consumption characteristic of the ADA4610-1/ADA4610-2/ADA4610-4 minimizes the die temperature, which warrants low input bias currents even at elevated ambient temperatures, making the amplifiers ideal for applications that require low leakage specifications without active cooling. Ensure proper printed circuit board (PCB) layout to minimize leakage currents between PCB traces. Improper layout and board handling can generate leakage currents exceeding the bias currents of the operational amplifier.

The ADA4610-1/ADA4610-2/ADA4610-4 are fully specified with supply voltages from $\pm 5\text{ V}$ to $\pm 15\text{ V}$ over the extended industrial temperature range of -40°C to $+125^\circ\text{C}$. The ADA4610-1 is available in an 8-lead SOIC. The ADA4610-2 is available in an 8-lead MSOP, an 8-lead SOIC, and an 8-lead LFCSP. The ADA4610-4 is available in a 14-lead SOIC and a 16-lead LFCSP. All these packages are surface-mount type.

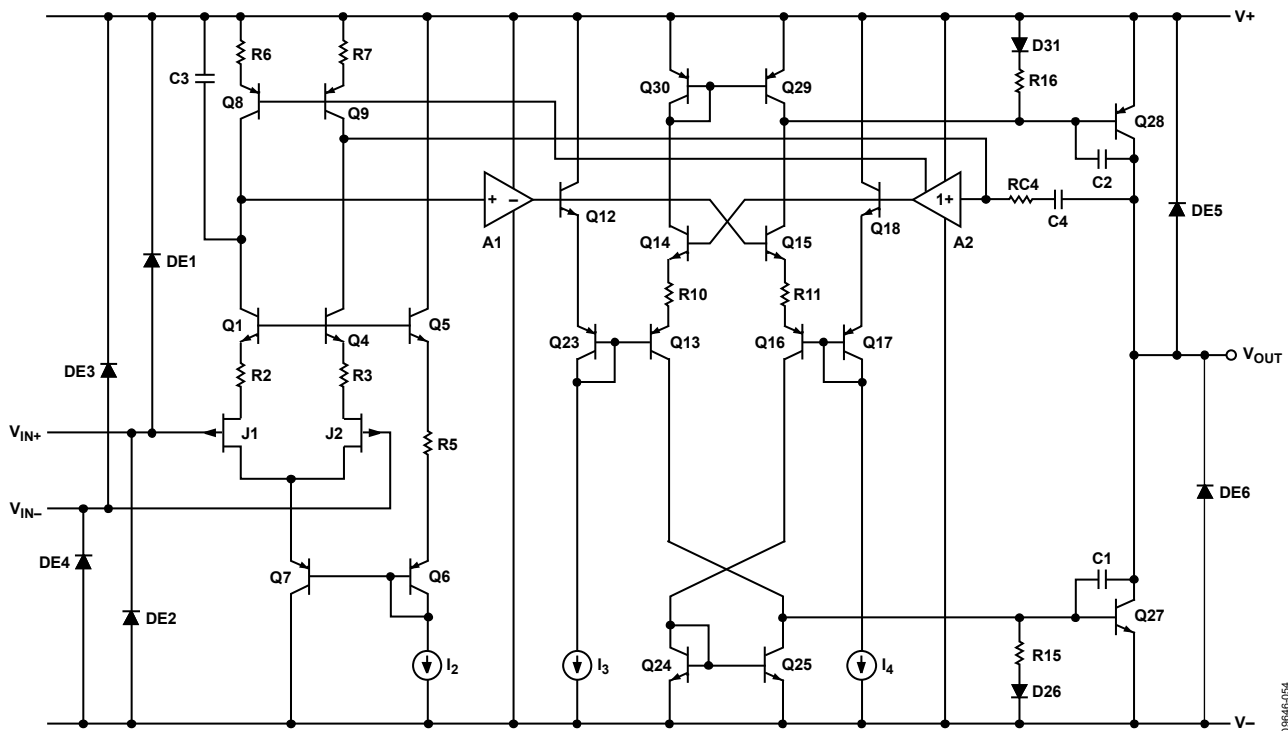

Figure 57. Simplified Schematic

0966c-054

APPLICATIONS INFORMATION

INPUT OVERVOLTAGE PROTECTION

The ADA4610-1/ADA4610-2/ADA4610-4 have internal protective circuitry that allows voltages as high as 0.3 V beyond the supplies to be applied at the input of either terminal without causing damage. For higher input voltages, a series resistor is necessary to limit the input current. Determine the resistor value by

$$\frac{V_{IN} - V_S}{R_S} \leq 10 \text{ mA}$$

where:

V_{IN} is the input voltage.

V_S is the voltage of either V_+ or V_- .

R_S is the series resistor.

With a very low bias current of <1.5 nA up to 125°C, higher resistor values can be used in series with the inputs. A 5 kΩ resistor protects the inputs from voltages as high as 25 V beyond the supplies and adds less than 10 μV to the offset.

PEAK DETECTOR

The function of a peak detector is to capture the peak value of a signal and produce an output equal to it. By taking advantage of the dc precision and super low input bias current of the JFET input amplifiers, such as the ADA4610-1/ADA4610-2/ADA4610-4, a highly accurate peak detector can be built, as shown in Figure 58.

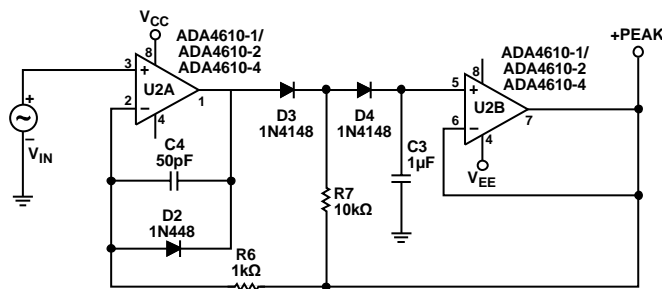

Figure 58. Positive Peak Detector

In this application, Diode D3 and Diode D4 act as unidirectional current switches that open up when the output is kept constant (in hold mode). To detect a positive peak, U2A drives C3 through D3 and D4 until C3 is charged to a voltage equal to the input peak value. Feedback from the output of the U2B + peak through R6 limits the output voltage of U2A. After detecting the peak, the output of U2A swings low but is clamped by D2. Diode D3 reverses bias and the common node of D3, D4, and R7 is held to a voltage equal to + peak by R7. The voltage across D4 is 0 V; therefore, its leakage is small. The bias current of U2B is also small. With almost no leakage, C3 has a long hold time.

The ADA4610-1/ADA4610-2/ADA4610-4, shown in Figure 58, are ideal for building a peak detector because U2A requires dc precision and high output current during fast peaks, and U2B requires low input bias current (I_B) to minimize capacitance discharge between peaks. A low leakage and low dielectric absorption capacitor, such as polystyrene or polypropylene, is required for C3. Reversing the diode directions causes the circuit to detect negative peaks.

CURRENT TO VOLTAGE (I TO V) CONVERSION APPLICATIONS

Photodiode Circuits

Common applications for I to V conversion include photodiode circuits where the amplifier converts a current emitted by a diode placed at the negative input terminal into an output voltage.

The low input bias current, wide bandwidth, and low noise of the ADA4610-1/ADA4610-2/ADA4610-4 make them excellent choices for various photodiode applications, including fax machines, fiber optic controls, motion sensors, and barcode readers.

The circuit shown in Figure 59 uses a silicon diode with zero bias voltage. This setup is a photovoltaic mode, which uses many large photodiodes. This configuration limits the overall noise and is suitable for instrumentation applications.

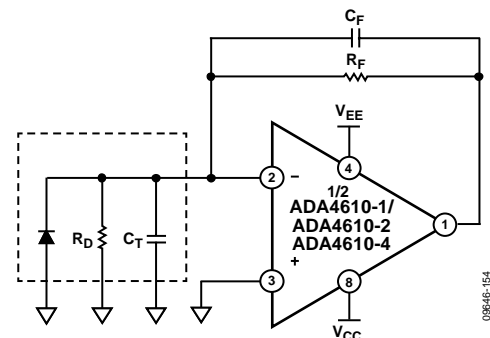

Figure 59. Equivalent Preamplifier Photodiode Circuit

A larger signal bandwidth can be attained at the expense of additional output noise. The total input capacitance (C_T) consists of the sum of the diode capacitance (typically 30 pF to 40 pF) and the amplifier input capacitance (<10 pF), which includes external parasitic capacitance. C_T creates a zero in the frequency response that can lead to an unstable system. To ensure stability and optimize the bandwidth of the signal, place a capacitor in the feedback loop of the circuit shown in Figure 59. The capacitor creates a pole and yields a bandwidth with a corner frequency of

$$1/(2\pi(R_F C_F))$$

where:

R_F is the feedback resistor.

C_F is the feedback capacitor

Determine the R_F value by the following ratio:

$$V/I_D$$

where:

V is the desired output voltage of the op amp.

I_D is the diode current.

For example, if I_D is 100 μA and a 10 V output voltage is needed, R_F must be 100 k Ω . The resistance of the photodiode (R_D) is a junction resistance (see Figure 59).

A typical value for R_D is 1000 M Ω . Because $R_D \gg R_F$, the circuit behavior is not impacted by the effect of the junction resistance. The maximum signal bandwidth (f_{MAX}) is

$$f_{MAX} = \sqrt{\frac{ft}{2\pi R_F C_T}}$$

where ft is the unity-gain frequency of the op amp.

Calculate C_F by

$$C_F = \sqrt{\frac{C_T}{2\pi R_F ft}}$$

where ft is the unity-gain frequency of the op amp, and achieves a phase margin, ϕ_M , of approximately 45°.

Increase the C_F value to obtain a higher phase margin. Setting C_F to twice the previous value yields approximately $\phi_M = 65^\circ$ and a maximal flat frequency response, but it reduces the maximum signal bandwidth by 50%.

Using the previous parameters with a $C_F \approx 7$ pF, the signal bandwidth is approximately 250 kHz.

COMPARATOR OPERATION

Although op amps are quite different from comparators, occasionally an unused section of a dual or a quad op amp can be used as a comparator; however, this is not recommended for rail-to-rail output op amps. For rail-to-rail output op amps, the output stage is generally a ratioed current mirror with bipolar or MOSFET transistors. With the device operating in open-loop mode, the second stage increases the current drive to the ratioed mirror to close the loop. However, the second stage cannot close the loop, which results in an increase in supply current. With the ADA4610-1/ADA4610-2/ADA4610-4 op amps configured as comparators, the supply current can be significantly higher (see Figure 60 for the supply current vs. the supply voltage for the ADA4610-4). Configuring an unused section as a voltage follower with the noninverting input connected to a voltage within the input voltage range is recommended. The ADA4610-1/ADA4610-2/ADA4610-4 have a unique output stage design that reduces the excess supply current but does not entirely eliminate this effect when the op amp is operating in open-loop mode.

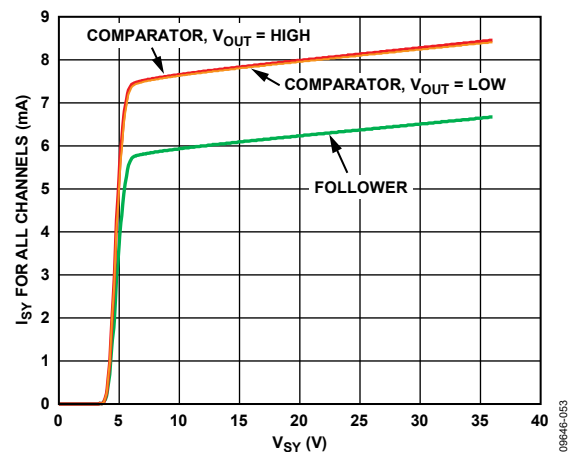

Figure 60. Supply Current (I_{SV}) vs. Supply Voltage (V_{SV}) for the ADA4610-4 Only

LONG-TERM DRIFT

The stability of a precision signal path over its lifetime or between calibration procedures is dependent on the long-term stability of the analog components in the path, such as op amps, references, and data converters. To help system designers predict the long-term drift of circuits that use the ADA4610-1/ADA4610-2/ADA4610-4, Analog Devices measured the offset voltage of multiple units for 10,000 hours (more than 13 months) using a high precision measurement system, including an ultrastable oil bath. To replicate real-world system performance, the devices under test (DUTs) were soldered onto an FR4 PCB using a standard reflow profile (as defined in the JEDEC J-STD-020D standard), as opposed to testing them in sockets. This manner of testing is important because expansion and contraction of the PCB can apply stress to the integrated circuit (IC) package and contribute to shifts in the offset voltage.

The ADA4610-1/ADA4610-2/ADA4610-4 have extremely low long-term drift, as shown in Figure 61. The red, blue, and green traces show sample units. Note that the ADA4610-1/ADA4610-2/ADA4610-4 (B-grade) have a mean drift over 10,000 hours of approximately 5 μV , or less than 2% of their maximum specified offset voltage of 400 μV at room temperature.

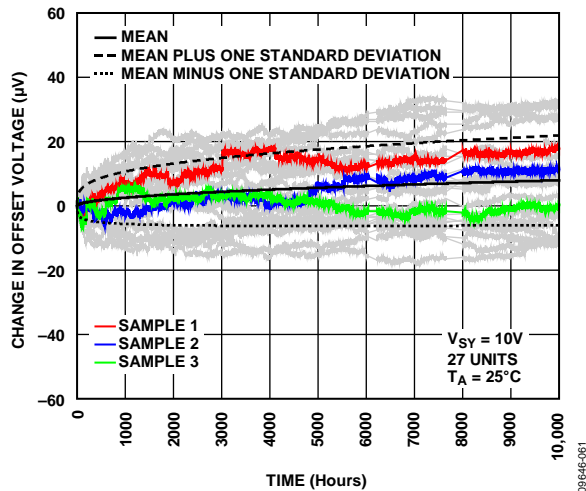

Figure 61. Measured Long-Term Drift of the ADA4610-1/ADA4610-2/ADA4610-4 Offset Voltage over 10,000 Hours

TEMPERATURE HYSTERESIS

In addition to stability over time as described in the Long-Term Drift section, it is useful to know the temperature hysteresis, that is, the stability vs. cycling of temperature. Hysteresis is an important parameter because it tells the system designer how closely the signal returns to its starting amplitude after the ambient temperature changes and subsequent return to room temperature. Figure 62 shows the change in input offset voltage as the temperature cycles three times from room temperature to $+125^\circ\text{C}$ to -40°C and back to room temperature. The dotted line is an initial preconditioning cycle to eliminate the original temperature-induced offset shift from exposure to production solder reflow temperatures. In the three full cycles, the offset hysteresis is typically only 8 μV , or 1% of its 800 μV maximum offset voltage over the full operating temperature range. The histogram in Figure 63 shows that the hysteresis is larger when the device is cycled through only a half cycle, from room temperature to 125°C and back to room temperature.

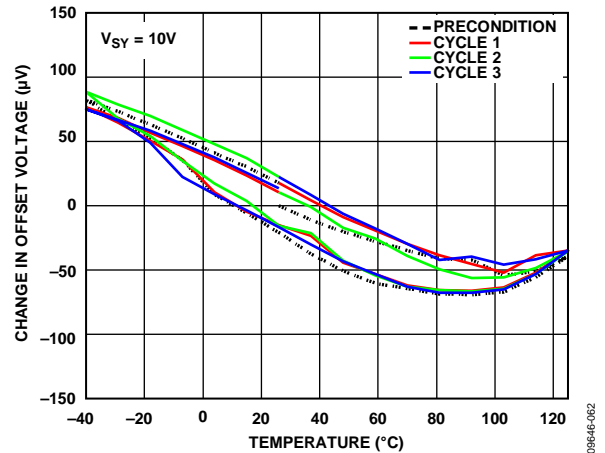

Figure 62. Change in Offset Voltage over Three Full Temperature Cycles

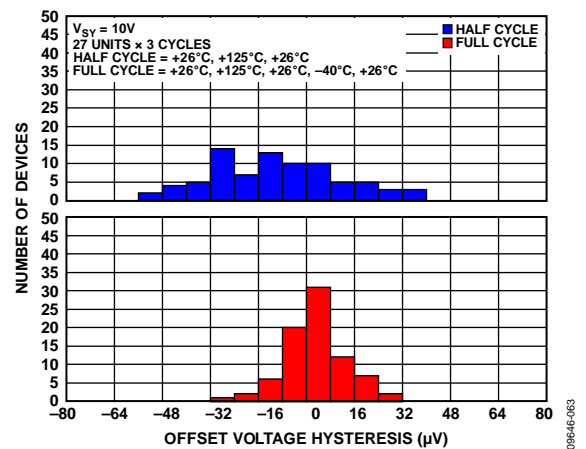
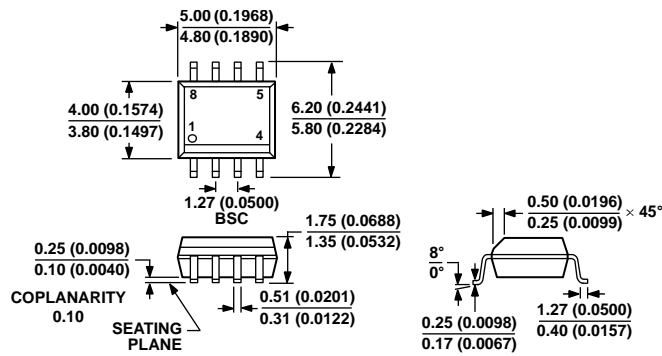

Figure 63. Histogram Showing the Temperature Hysteresis of the Offset Voltage over Three Full Cycles and over Three Half Cycles

OUTLINE DIMENSIONS



COMPLIANT TO JEDEC STANDARDS MS-012-AA
 CONTROLLING DIMENSIONS ARE IN MILLIMETERS; INCH DIMENSIONS
 (IN PARENTHESES) ARE ROUNDED-OFF MILLIMETER EQUIVALENTS FOR
 REFERENCE ONLY AND ARE NOT APPROPRIATE FOR USE IN DESIGN.

Figure 64. 8-Lead Standard Small Outline Package [SOIC_N]
 Narrow Body
 (R-8)

Dimensions shown in millimeters and (inches)

012407-A

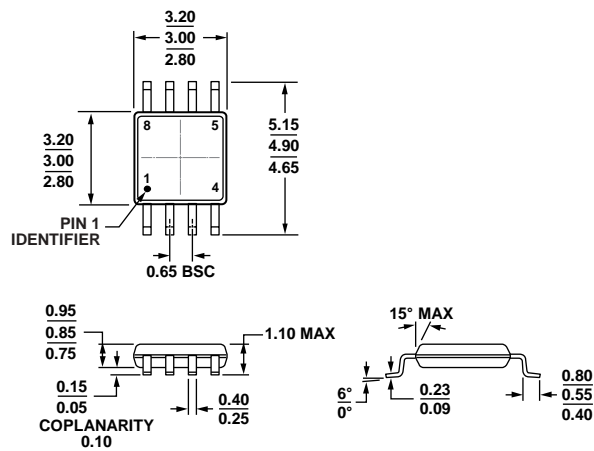

COMPLIANT TO JEDEC STANDARDS MO-187-AA

Figure 65. 8-Lead Mini Small Outline Package [MSOP]
 (RM-8)

Dimensions shown in millimeters

10-07-2009-B

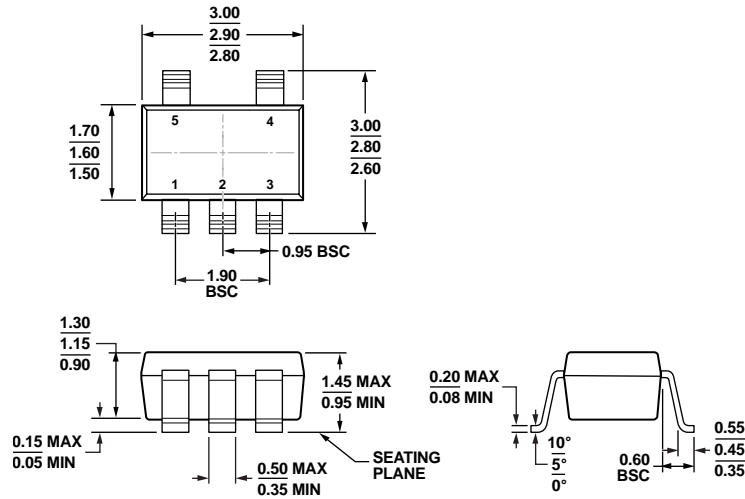

11-01-2016-A

COMPLIANT TO JEDEC STANDARDS MO-178-AA
 Figure 66. 5-Lead Small Outline Transistor Package [SOT-23]
 (RJ-5)
 Dimensions shown in millimeters

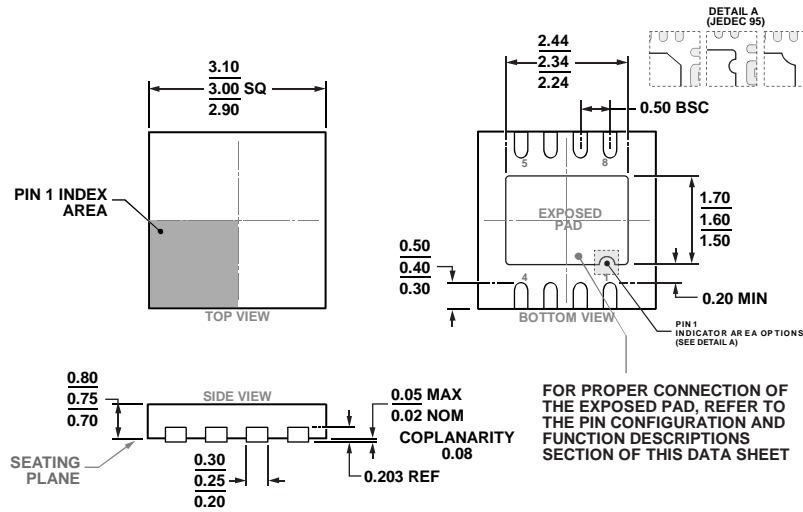

08-17-2018-C

COMPLIANT TO JEDEC STANDARDS MO-229-W3030D-4
 Figure 67. 8-Lead Lead Frame Chip Scale Package [LFCSP]
 3 mm x 3 mm Body and 0.75 mm Package Height
 (CP-8-11)
 Dimensions shown in millimeters

FOR PROPER CONNECTION OF THE EXPOSED PAD, REFER TO THE PIN CONFIGURATION AND FUNCTION DESCRIPTIONS SECTION OF THIS DATA SHEET

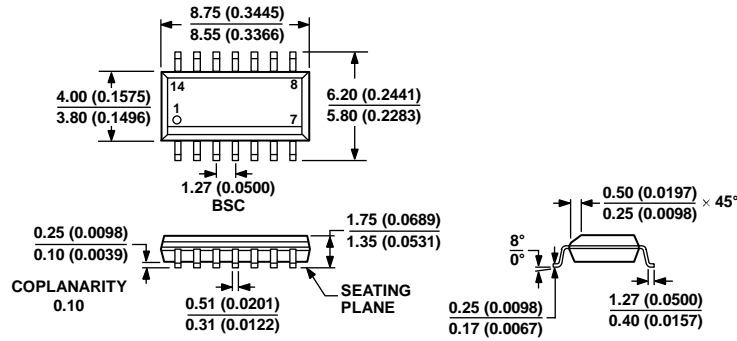

COMPLIANT TO JEDEC STANDARDS MS-012-AB
 CONTROLLING DIMENSIONS ARE IN MILLIMETERS; INCH DIMENSIONS (IN PARENTHESES) ARE ROUNDED-OFF MILLIMETER EQUIVALENTS FOR REFERENCE ONLY AND ARE NOT APPROPRIATE FOR USE IN DESIGN.

060606-A

Figure 68. 14-Lead Standard Small Outline Package [SOIC_N] Narrow Body (R-14)
 Dimensions shown in millimeters and (inches)

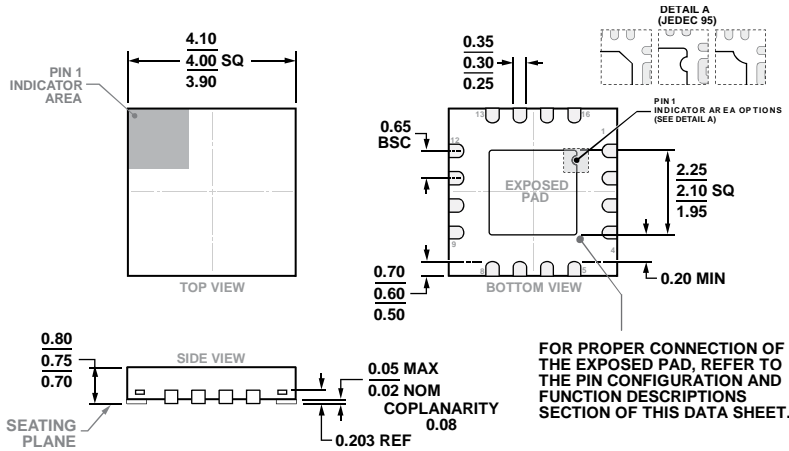

COMPLIANT TO JEDEC STANDARDS MO-220-WGGC.

Figure 69. 16-Lead Lead Frame Chip Scale Package [LFCSF] 4 mm x 4 mm Body and 0.75 mm Package Height (CP-16-23)
 Dimensions shown in millimeters

PKG-000025B112

08-24-2018-B