

# ADA4622-1/ADA4622-2/ADA4622-4

30 V, 8 MHz, Low Bias Current, Single Supply, RRO, Precision Op Amp

## FEATURES

- ▶ Next generation of the [AD820/AD822/AD824](#)
- ▶ Wide gain bandwidth product: 8 MHz typical
- ▶ High slew rate
  - ▶ 23 V/ $\mu$ s typical (low to high)
  - ▶ -18 V/ $\mu$ s typical (high to low)
- ▶ Low input bias current:  $\pm 10$  pA maximum at  $T_A = 25^\circ\text{C}$
- ▶ Low offset voltage
  - ▶ A grade:  $\pm 0.8$  mV maximum at  $T_A = 25^\circ\text{C}$
  - ▶ B grade:  $\pm 0.35$  mV maximum at  $T_A = 25^\circ\text{C}$
- ▶ Low offset voltage drift
  - ▶ A grade:  $\pm 4$   $\mu\text{V}/^\circ\text{C}$  maximum
  - ▶ B grade:  $\pm 2$   $\mu\text{V}/^\circ\text{C}$  maximum (ADA4622-2 only)
  - ▶ B grade:  $\pm 1$   $\mu\text{V}/^\circ\text{C}$  maximum (ADA4622-1 only)
- ▶ Input voltage range includes Pin V-
- ▶ Rail-to-rail output
- ▶ Electromagnetic interference rejection ratio (EMIRR)
  - ▶ 90 dB typical at  $f = 1000$  MHz and  $f = 2400$  MHz
- ▶ Industry-standard package and pinouts

## APPLICATIONS

- ▶ High output impedance sensor interfaces
- ▶ Photodiode sensor interfaces
- ▶ Transimpedance amplifiers
- ▶ ADC drivers
- ▶ Precision filters and signal conditioning

## PIN CONFIGURATION

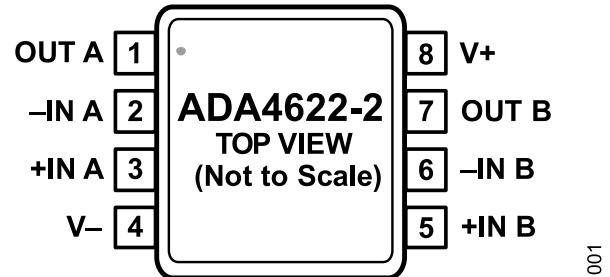


Figure 1. 8-Lead Mini Small Outline Package [MSOP] Pin Configuration (See the [Pin Configurations and Function Descriptions](#) Section for Additional Pin Configurations)

## GENERAL DESCRIPTION

The ADA4622-1/ADA4622-2/ADA4622-4 are the next generation of the [AD820/AD822/AD824](#) single-supply, rail-to-rail output (RRO), precision junction field effect transistors (JFET) input op amps. The ADA4622-1/ADA4622-2/ADA4622-4 include many improvements that make them desirable as upgrades without compromising the flexibility and ease of use that makes the AD820/AD822/AD824 useful for a wide variety of applications.

The input voltage range includes the negative supply and the output swings rail-to-rail. Input EMI filters increase the signal robustness in the face of closely located switching noise sources.

The speed, in terms of bandwidth and slew rate, increases along with a strong output drive to improve settling time performance and enables the devices to drive the inputs of modern single-ended, successive approximation register (SAR) analog-to-digital converters (ADCs).

Voltage noise is reduced; although the supply current remains the same as the AD820/AD822/AD824, broadband noise is reduced by 25%, and 1/f is reduced by half. DC precision in the ADA4622-1/ADA4622-2/ADA4622-4 improved from the AD820/AD822/AD824 with half the offset and a maximum thermal drift specification added to the ADA4622-1/ADA4622-2/ADA4622-4. The common-mode rejection ratio (CMRR) is improved from the AD820/AD822/AD824 to make the ADA4622-1/ADA4622-2/ADA4622-4 more suitable when used in noninverting gain and difference amplifier configurations.

The ADA4622-1/ADA4622-2/ADA4622-4 are specified for operation over the extended industrial temperature range of  $-40^\circ\text{C}$  to  $+125^\circ\text{C}$ , and operate from 5 V to 30 V, with specifications at +5 V,  $\pm 5$  V, and  $\pm 15$  V. The ADA4622-1 is available in a [5-lead SOT-23 package](#) and an [8-lead LFCSP package](#). The ADA4622-2 is available in an [8-lead SOIC\\_N package](#), an [8-lead MSOP package](#), and an 8-lead LFCSP package. The ADA4622-4 is available in a [14-lead SOIC\\_N](#) and a [16-lead, 4 x 4 mm LFCSP](#).

**TABLE OF CONTENTS**

Features.....	1	Input Characteristics.....	26
Applications.....	1	Output Characteristics.....	27
Pin Configuration.....	1	Shutdown Operation.....	28
General Description.....	1	Applications Information.....	29
Specifications.....	3	Recommended Power Solution.....	29
Electrical Characteristics, $V_{SY} = \pm 15\text{ V}$ .....	3	Maximum Power Dissipation.....	29
Electrical Characteristics, $V_{SY} = \pm 5\text{ V}$ .....	5	Second-Order Low-Pass Filter.....	29
Electrical Characteristics, $V_{SY} = 5\text{ V}$ .....	7	Wideband Photodiode Preamplifier.....	29
Absolute Maximum Ratings.....	10	Peak Detector.....	32
Thermal Resistance.....	10	Multiplexing Inputs.....	32
ESD Caution.....	10	Full Wave Rectifier.....	32
Pin Configurations and Function Descriptions.....	11	Outline Dimensions.....	34
Typical Performance Characteristics.....	14	Ordering Guide.....	36
Theory Of Operation.....	26		

**REVISION HISTORY****9/2022—Rev. E to Rev. F**

Changes to Features Section.....	1
Changes to Offset Voltage Drift, B Grade Parameter, Table 1.....	3
Changes to Offset Voltage Drift, B Grade Parameter, Table 2.....	5
Changes to Offset Voltage Drift, B Grade Parameter, Table 3.....	7
Changes to Figure 12 to Figure 14.....	14

## SPECIFICATIONS

ELECTRICAL CHARACTERISTICS,  $V_{SY} = \pm 15\text{ V}$ 

Supply voltage ( $V_{SY}$ ) =  $\pm 15\text{ V}$ , common-mode voltage ( $V_{CM}$ ) = output voltage ( $V_{OUT}$ ) =  $0\text{ V}$ ,  $T_A = 25^\circ\text{C}$ , unless otherwise noted.

Table 1.

Parameter	Symbol	Test Conditions/Comments	Min	Typ	Max	Unit					
INPUT CHARACTERISTICS											
Offset Voltage	$V_{OS}$	$-40^\circ\text{C} < T_A < +125^\circ\text{C}$									
A Grade								+0.04	$\pm 0.8$	mV	
B Grade								+0.04	$\pm 2$	mV	
ADA4622-1									$\pm 0.35$	mV	
ADA4622-2									$\pm 1$	mV	
Offset Voltage Match					$\pm 0.8$	mV					
Offset Voltage Drift	$\Delta V_{OS}/\Delta T$	$-40^\circ\text{C} < T_A < +125^\circ\text{C}$									
A Grade									$\pm 4$	$\mu\text{V}/^\circ\text{C}$	
B Grade										$\pm 1$	$\mu\text{V}/^\circ\text{C}$
ADA4622-1										$\pm 2$	$\mu\text{V}/^\circ\text{C}$
ADA4622-2											$\mu\text{V}/^\circ\text{C}$
Input Bias Current	$I_B$	$-40^\circ\text{C} < T_A < +125^\circ\text{C}$ $V_{CM} = -15\text{ V}$									
							+2	$\pm 10$	pA		
								$\pm 1.5$	nA		
Input Offset Current	$I_{OS}$	$-40^\circ\text{C} < T_A < +125^\circ\text{C}$									
								$\pm 10$	pA		
								$\pm 0.5$	nA		
Input Voltage Range	IVR		-15.2		+14	V					
Common-Mode Rejection Ratio	CMRR	$V_{CM} = -15\text{ V to } +12\text{ V}$ $-40^\circ\text{C} < T_A < +125^\circ\text{C}$									
A Grade							84	100	dB		
B Grade							81		dB		
							87	100	dB		
Open-Loop Voltage Gain	$A_{VO}$	$R_L = 10\text{ k}\Omega$ , $V_{OUT} = -14.5\text{ V to } +14.5\text{ V}$ $-40^\circ\text{C} < T_A < +125^\circ\text{C}$									
							117	122	dB		
							109		dB		
							102	110	dB		
Input Capacitance	$C_{INDM}$ $C_{INCM}$	Differential mode Common mode									
							0.4	3.6	pF		
Input Resistance	$R_{DIFF}$ $R_{CM}$	Differential mode Common mode									
							$10^{13}$	$10^{13}$	$\Omega$		
OUTPUT CHARACTERISTICS											
Output Voltage	$V_{OH}$	$I_{SOURCE} = 1\text{ mA}$ $-40^\circ\text{C} < T_A < +125^\circ\text{C}$									
High							14.95	14.97	V		
							14.9		V		
							14.3	14.5	V		
							14.1		V		
Low	$V_{OL}$	$I_{SINK} = 1\text{ mA}$ $-40^\circ\text{C} < T_A < +125^\circ\text{C}$									
								-14.955	-14.935	V	
									-14.88	V	
		$I_{SINK} = 15\text{ mA}$									
					-14.685	-14.55	V				

## SPECIFICATIONS

Table 1.

Parameter	Symbol	Test Conditions/Comments	Min	Typ	Max	Unit
Output Current	$I_{OUT}$	$-40^{\circ}\text{C} < T_A < +125^{\circ}\text{C}$ $V_{DROPOUT} < 1\text{ V}$		20	-14.25	V mA
Short-Circuit Current	$I_{SC}$	Sourcing		42		mA
		Sinking		-51		mA
Closed-Loop Output Impedance	$Z_{OUT}$	$f = 1\text{ kHz}$ , gain ( $A_V$ ) = 1		0.1		$\Omega$
		$A_V = 10$		0.4		$\Omega$
		$A_V = 100$		3		$\Omega$
POWER SUPPLY						
Power Supply Rejection Ratio	PSRR	$V_{SY} = \pm 4\text{ V}$ to $\pm 18\text{ V}$ $-40^{\circ}\text{C} < T_A < +125^{\circ}\text{C}$	87 81	103		dB dB
Supply Current per Amplifier	$I_{SY}$	$-40^{\circ}\text{C} < T_A < +125^{\circ}\text{C}$		715	750	$\mu\text{A}$
ADA4622-1/ADA4622-4					775	$\mu\text{A}$
ADA4622-2				665	700	$\mu\text{A}$
Shutdown Current			ADA4622-1 only	60	725	$\mu\text{A}$
DYNAMIC PERFORMANCE						
Slew Rate	SR	$V_{OUT} = \pm 12.5\text{ V}$ , $R_L = 2\text{ k}\Omega$ , load capacitor ( $C_L$ ) = 100 pF, $A_V = 1$ Low to high transition High to low transition		23 -18		V/ $\mu\text{s}$ V/ $\mu\text{s}$
Gain Bandwidth Product	GBP	$A_V = 100$ , $C_L = 35\text{ pF}$		8		MHz
Unity-Gain Crossover	UGC	$A_V = 1$		7		MHz
-3 dB Bandwidth	-3 dB	$A_V = 1$		15.5		MHz
Phase Margin	$\Phi_M$			53		Degrees
Settling Time	$t_S$	Input voltage ( $V_{IN}$ ) = 10 V step, $R_L = 2\text{ k}\Omega$ , $C_L =$ 15 pF, $A_V = -1$		1.5 2		$\mu\text{s}$ $\mu\text{s}$
To 0.1%						
To 0.01%						
EMI REJECTION RATIO						
$f = 1000\text{ MHz}$	EMIRR	$V_{IN} = 100\text{ mV p-p}$		90		dB
$f = 2400\text{ MHz}$				90		dB
NOISE PERFORMANCE						
Voltage Noise	$e_N$ p-p	0.1 Hz to 10 Hz		0.75		$\mu\text{V p-p}$
Voltage Noise Density	$e_N$	$f = 10\text{ Hz}$		30		nV/ $\sqrt{\text{Hz}}$
		$f = 100\text{ Hz}$		15		nV/ $\sqrt{\text{Hz}}$
		$f = 1\text{ kHz}$		12.5		nV/ $\sqrt{\text{Hz}}$
		$f = 10\text{ kHz}$		12		nV/ $\sqrt{\text{Hz}}$
		$f = 1\text{ kHz}$		0.8		fA/ $\sqrt{\text{Hz}}$
Current Noise Density	$i_N$	$f = 1\text{ kHz}$		0.8		fA/ $\sqrt{\text{Hz}}$
Total Harmonic Distortion + Noise	THD + N	$A_V = 1$ , $f = 10\text{ Hz}$ to $20\text{ kHz}$ , $V_{IN} = 7\text{ V rms}$ at 1 kHz				
Bandwidth (BW) = 80 kHz				0.0003		%
BW = 500 kHz				0.00035		%
MATCHING SPECIFICATIONS						
Maximum Offset Voltage over Temperature				0.5		mV

## SPECIFICATIONS

Table 1.

Parameter	Symbol	Test Conditions/Comments	Min	Typ	Max	Unit
Offset Voltage Temperature Drift				0.25		$\mu\text{V}/^\circ\text{C}$
Input Bias Current				0.5	5	pA
CROSSTALK	$C_S$	$R_L = 5\text{ k}\Omega$ , $V_{IN} = 20\text{ V p-p}$				
ADA4622-1/ADA4622-2		$f = 1\text{ kHz}$		-112		dB
		$f = 100\text{ kHz}$		-72		dB
ADA4622-4		$f = 1\text{ kHz}$		-106		dB
		$f = 100\text{ kHz}$		-66		dB

ELECTRICAL CHARACTERISTICS,  $V_{SY} = \pm 5\text{ V}$ 

$V_{SY} = \pm 5\text{ V}$ ,  $V_{CM} = V_{OUT} = 0\text{ V}$ ,  $T_A = 25^\circ\text{C}$ , unless otherwise noted.

Table 2.

Parameter	Symbol	Test Conditions/Comments	Min	Typ	Max	Unit
INPUT CHARACTERISTICS						
Offset Voltage	$V_{OS}$					
A Grade				+0.04	$\pm 0.8$	mV
		$-40^\circ\text{C} < T_A < +125^\circ\text{C}$			$\pm 2$	mV
B Grade				+0.04	$\pm 0.35$	mV
ADA4622-1		$-40^\circ\text{C} < T_A < +125^\circ\text{C}$			$\pm 1$	mV
ADA4622-2		$-40^\circ\text{C} < T_A < +125^\circ\text{C}$			$\pm 0.8$	mV
Offset Voltage Match					$\pm 1$	mV
Offset Voltage Drift	$\Delta V_{OS}/\Delta T$					
A Grade		$-40^\circ\text{C} < T_A < +125^\circ\text{C}$			$\pm 4$	$\mu\text{V}/^\circ\text{C}$
B Grade						
ADA4622-1		$-40^\circ\text{C} < T_A < +125^\circ\text{C}$			$\pm 1$	$\mu\text{V}/^\circ\text{C}$
ADA4622-2		$-40^\circ\text{C} < T_A < +125^\circ\text{C}$			$\pm 2$	$\mu\text{V}/^\circ\text{C}$
Input Bias Current	$I_B$			+2	$\pm 10$	pA
		$-40^\circ\text{C} < T_A < +125^\circ\text{C}$			$\pm 1.5$	nA
		$V_{CM} = V^-$		-5		pA
Input Offset Current	$I_{OS}$				$\pm 10$	pA
		$-40^\circ\text{C} < T_A < +125^\circ\text{C}$			$\pm 0.5$	nA
Input Voltage Range	IVR		-5.2		+4	V
Common-Mode Rejection Ratio	CMRR					
A Grade		$V_{CM} = -5\text{ V to }+2\text{ V}$	75	91		dB
		$-40^\circ\text{C} < T_A < +125^\circ\text{C}$	73			dB
B Grade		$V_{CM} = -5\text{ V to }+2\text{ V}$	78	91		dB
		$-40^\circ\text{C} < T_A < +125^\circ\text{C}$	75			dB
Open-Loop Voltage Gain	$A_{VO}$					
		$R_L = 10\text{ k}\Omega$ , $V_{OUT} = -4.4\text{ V to }+4.4\text{ V}$	113	118		dB
		$-40^\circ\text{C} < T_A < +125^\circ\text{C}$	105			dB
		$R_L = 1\text{ k}\Omega$ , $V_{OUT} = -4.4\text{ V to }+4.4\text{ V}$	100	105		dB
		$-40^\circ\text{C} < T_A < +125^\circ\text{C}$	91			dB
Input Capacitance	$C_{INDM}$	Differential mode		0.4		pF
	$C_{INCM}$	Common mode		3.6		pF
Input Resistance	$R_{DIFF}$	Differential mode		$10^{13}$		$\Omega$
	$R_{CM}$	Common mode		$10^{13}$		$\Omega$

## SPECIFICATIONS

Table 2.

Parameter	Symbol	Test Conditions/Comments	Min	Typ	Max	Unit
<b>OUTPUT CHARACTERISTICS</b>						
Output Voltage						
High	$V_{OH}$	$I_{SOURCE} = 1\text{ mA}$ $-40^{\circ}\text{C} < T_A < +125^{\circ}\text{C}$	4.95	4.97		V
		$I_{SOURCE} = 15\text{ mA}$ $-40^{\circ}\text{C} < T_A < +125^{\circ}\text{C}$	4.9			V
			4.3	4.51		V
Low	$V_{OL}$	$I_{SINK} = 1\text{ mA}$ $-40^{\circ}\text{C} < T_A < +125^{\circ}\text{C}$	4.1			V
		$I_{SINK} = 15\text{ mA}$ $-40^{\circ}\text{C} < T_A < +125^{\circ}\text{C}$		-4.955	-4.935	V
					-4.88	V
				-4.685	-4.55	V
					-4.25	V
Output Current	$I_{OUT}$	$V_{DROPOUT} < 1\text{ V}$		20		mA
Short-Circuit Current	$I_{SC}$	Sourcing		31		mA
		Sinking		-40		mA
Closed-Loop Output Impedance	$Z_{OUT}$	$f = 1\text{ kHz}$ , $A_V = 1$ $A_V = 10$ $A_V = 100$		0.1		$\Omega$
				0.4		$\Omega$
				4		$\Omega$
<b>POWER SUPPLY</b>						
Power Supply Rejection Ratio	PSRR	$V_{SY} = \pm 4\text{ V to } \pm 18\text{ V}$ $-40^{\circ}\text{C} < T_A < +125^{\circ}\text{C}$	87	103		dB
			81			dB
Supply Current per Amplifier	$I_{SY}$					
ADA4622-1/ADA4622-4		$-40^{\circ}\text{C} < T_A < +125^{\circ}\text{C}$		660	725	$\mu\text{A}$
					750	$\mu\text{A}$
ADA4622-2		$-40^{\circ}\text{C} < T_A < +125^{\circ}\text{C}$		610	675	$\mu\text{A}$
					700	$\mu\text{A}$
Shutdown Current		ADA4622-1 only		50		$\mu\text{A}$
<b>DYNAMIC PERFORMANCE</b>						
Slew Rate	SR	$V_{OUT} = \pm 3\text{ V}$ , $R_L = 2\text{ k}\Omega$ , $C_L = 100\text{ pF}$ , $A_V = 1$ Low to high transition High to low transition		21 -16		V/ $\mu\text{s}$ V/ $\mu\text{s}$
Gain Bandwidth Product	GBP	$A_V = 100$ , $C_L = 35\text{ pF}$		7.8		MHz
Unity-Gain Crossover	UGC	$A_V = 1$		6.5		MHz
-3 dB Bandwidth	-3 dB	$A_V = 1$		10		MHz
Phase Margin	$\Phi_M$			50		Degrees
Settling Time	$t_s$	$V_{IN} = 8\text{ V step}$ , $R_L = 2\text{ k}\Omega$ , $C_L = 15\text{ pF}$ , $A_V = -1$				
To 0.1%				1.5		$\mu\text{s}$
To 0.01%				2		$\mu\text{s}$
<b>EMI REJECTION RATIO</b>						
$f = 1000\text{ MHz}$	EMIRR	$V_{IN} = 100\text{ mV p-p}$		90		dB
$f = 2400\text{ MHz}$				90		dB
<b>NOISE PERFORMANCE</b>						
Voltage Noise	$e_N\text{ p-p}$	0.1 Hz to 10 Hz		0.75		$\mu\text{V p-p}$
Voltage Noise Density	$e_N$	$f = 10\text{ Hz}$ $f = 100\text{ Hz}$ $f = 1\text{ kHz}$ $f = 10\text{ kHz}$		30 15 12.5 12		nV/ $\sqrt{\text{Hz}}$ nV/ $\sqrt{\text{Hz}}$ nV/ $\sqrt{\text{Hz}}$ nV/ $\sqrt{\text{Hz}}$

## SPECIFICATIONS

Table 2.

Parameter	Symbol	Test Conditions/Comments	Min	Typ	Max	Unit
Current Noise Density	$i_N$	$f = 1 \text{ kHz}$		0.8		$\text{fA}/\sqrt{\text{Hz}}$
Total Harmonic Distortion + Noise	THD + N	$A_V = 1, f = 10 \text{ Hz to } 20 \text{ kHz}, V_{IN} = 1.5 \text{ V rms at } 1 \text{ kHz}$				
BW = 80 kHz				0.0005		%
BW = 500 kHz				0.0008		%
MATCHING SPECIFICATIONS						
Maximum Offset Voltage over Temperature				0.5		mV
Offset Voltage Temperature Drift				0.25		$\mu\text{V}/^\circ\text{C}$
Input Bias Current				0.5	5	pA
CROSSTALK	$C_S$	$R_L = 5 \text{ k}\Omega, V_{IN} = 6 \text{ V p-p}$				
ADA4622-1/ADA4622-2		$f = 1 \text{ kHz}$		-112		dB
		$f = 100 \text{ kHz}$		-72		dB
ADA4622-4		$f = 1 \text{ kHz}$		-106		dB
		$f = 100 \text{ kHz}$		-66		dB

ELECTRICAL CHARACTERISTICS,  $V_{SY} = 5 \text{ V}$ 

$V_{SY} = 5 \text{ V}, V_{CM} = 0 \text{ V}, V_{OUT} = V_{SY}/2, T_A = 25^\circ\text{C}$ , unless otherwise noted.

Table 3.

Parameter	Symbol	Test Conditions/Comments	Min	Typ	Max	Unit
INPUT CHARACTERISTICS						
Offset Voltage	$V_{OS}$					
A Grade		$-40^\circ\text{C} < T_A < +125^\circ\text{C}$		+0.04	$\pm 0.8$	mV
B Grade		$-40^\circ\text{C} < T_A < +125^\circ\text{C}$		+0.04	$\pm 2$	mV
ADA4622-1		$-40^\circ\text{C} < T_A < +125^\circ\text{C}$			$\pm 0.35$	mV
ADA4622-2		$-40^\circ\text{C} < T_A < +125^\circ\text{C}$			$\pm 1$	mV
Offset Voltage Match					$\pm 0.8$	mV
Offset Voltage Drift	$\Delta V_{OS}/\Delta T$				$\pm 1$	mV
A Grade		$-40^\circ\text{C} < T_A < +125^\circ\text{C}$			$\pm 4$	$\mu\text{V}/^\circ\text{C}$
B Grade		$-40^\circ\text{C} < T_A < +125^\circ\text{C}$			$\pm 1$	$\mu\text{V}/^\circ\text{C}$
ADA4622-1		$-40^\circ\text{C} < T_A < +125^\circ\text{C}$			$\pm 2$	$\mu\text{V}/^\circ\text{C}$
ADA4622-2		$-40^\circ\text{C} < T_A < +125^\circ\text{C}$			$\pm 2$	$\mu\text{V}/^\circ\text{C}$
Input Bias Current	$I_B$	$-40^\circ\text{C} < T_A < +125^\circ\text{C}$		2	$\pm 10$	pA
Input Offset Current	$I_{OS}$	$-40^\circ\text{C} < T_A < +125^\circ\text{C}$			$\pm 1.5$	nA
Input Voltage Range	IVR		-0.2		+4	V
Common-Mode Rejection Ratio	CMRR					
A Grade		$V_{CM} = 0 \text{ V to } 2 \text{ V}$	70	87		dB
		$-40^\circ\text{C} < T_A < +125^\circ\text{C}$	67			dB
B Grade		$V_{CM} = 0 \text{ V to } 2 \text{ V}$	73	87		dB
		$-40^\circ\text{C} < T_A < +125^\circ\text{C}$	70			dB
Open-Loop Voltage Gain	$A_{VO}$	$R_L = 10 \text{ k}\Omega \text{ to } V-, V_{OUT} = 0.2 \text{ V to } 4.6 \text{ V}$	110	115		dB
		$-40^\circ\text{C} < T_A < +125^\circ\text{C}$	99			dB

## SPECIFICATIONS

Table 3.

Parameter	Symbol	Test Conditions/Comments	Min	Typ	Max	Unit	
Input Capacitance	$C_{INDM}$	$R_L = 1\text{ k}\Omega$ to $V^-$ , $V_{OUT} = 0.2\text{ V}$ to $4.6\text{ V}$	96	104		dB	
		$-40^\circ\text{C} < T_A < +125^\circ\text{C}$	87			dB	
		Differential mode		0.4		pF	
		Common mode		3.6		pF	
				$10^{13}$			$\Omega$
Input Resistance	$R_{DIFF}$	Differential mode		$10^{13}$		$\Omega$	
	$R_{CM}$	Common mode		$10^{13}$		$\Omega$	
OUTPUT CHARACTERISTICS							
Output Voltage High	$V_{OH}$	$I_{SOURCE} = 1\text{ mA}$	4.95	4.97		V	
		$-40^\circ\text{C} < T_A < +125^\circ\text{C}$	4.9			V	
Low	$V_{OL}$	$I_{SOURCE} = 15\text{ mA}$	4.3	4.5		V	
		$-40^\circ\text{C} < T_A < +125^\circ\text{C}$	4.1			V	
		$I_{SINK} = 1\text{ mA}$		45	65	mV	
		$-40^\circ\text{C} < T_A < +125^\circ\text{C}$			120	mV	
Output Current	$I_{OUT}$	$I_{SINK} = 15\text{ mA}$		310	450	mV	
		$-40^\circ\text{C} < T_A < +125^\circ\text{C}$			750	mV	
Short-Circuit Current	$I_{SC}$	$V_{DROPOUT} < 1\text{ V}$		20		mA	
		Sourcing		27		mA	
Closed-Loop Output Impedance	$Z_{OUT}$	Sinking		-35		mA	
		$f = 1\text{ kHz}$ , $A_V = 1$		0.1		$\Omega$	
		$A_V = 10$		0.6		$\Omega$	
		$A_V = 100$		5		$\Omega$	
POWER SUPPLY							
Power Supply Rejection Ratio	PSRR	$V_{SY} = 4\text{ V}$ to $15\text{ V}$	80	95		dB	
		$-40^\circ\text{C} < T_A < +125^\circ\text{C}$	74			dB	
Supply Current per Amplifier ADA4622-1/ADA4622-4	$I_{SY}$	$-40^\circ\text{C} < T_A < +125^\circ\text{C}$		650	700	$\mu\text{A}$	
						725	$\mu\text{A}$
				600	650	$\mu\text{A}$	
					675	$\mu\text{A}$	
Shutdown Current		ADA4622-1 only		50		$\mu\text{A}$	
DYNAMIC PERFORMANCE							
Slew Rate	SR	$V_{OUT} = 0.5\text{ V}$ to $3.5\text{ V}$ , $R_L = 2\text{ k}\Omega$ , $C_L = 100\text{ pF}$ , $A_V = 1$					
		Low to high transition		20		V/ $\mu\text{s}$	
		High to low transition		-15		V/ $\mu\text{s}$	
Gain Bandwidth Product	GBP	$A_V = 100$ , $C_L = 35\text{ pF}$		7.2		MHz	
Unity-Gain Crossover	UGC	$A_V = 1$		6		MHz	
-3 dB Bandwidth	-3 dB	$A_V = 1$		9		MHz	
Phase Margin	$\Phi_M$			50		Degrees	
Settling Time	$t_S$	$V_{IN} = 4\text{ V}$ step, $R_L = 2\text{ k}\Omega$ , $C_L = 15\text{ pF}$ , $A_V = -1$		1.5		$\mu\text{s}$	
		To 0.01%		2.0		$\mu\text{s}$	
EMI REJECTION RATIO $f = 1000\text{ MHz}$	EMIRR	$V_{IN} = 100\text{ mV}$ p-p		90		dB	



## SPECIFICATIONS

Table 3.

Parameter	Symbol	Test Conditions/Comments	Min	Typ	Max	Unit
f = 2400 MHz				90		dB
<b>NOISE PERFORMANCE</b>						
Voltage Noise	$e_N$ p-p	0.1 Hz to 10 Hz		0.75		$\mu\text{V p-p}$
Voltage Noise Density	$e_N$	f = 10 Hz		30		$\text{nV}/\sqrt{\text{Hz}}$
		f = 100 Hz		15		$\text{nV}/\sqrt{\text{Hz}}$
		f = 1 kHz		12.5		$\text{nV}/\sqrt{\text{Hz}}$
		f = 10 kHz		12		$\text{nV}/\sqrt{\text{Hz}}$
Current Noise Density	$i_N$	f = 1 kHz		0.8		$\text{fA}/\sqrt{\text{Hz}}$
Total Harmonic Distortion + Noise	THD + N	$A_V = 1$ , f = 10 Hz to 20 kHz, $V_{IN} = 0.5 \text{ V rms}$ at 1 kHz				
BW = 80 kHz				0.0025		%
BW = 500 kHz				0.0025		%
<b>MATCHING SPECIFICATIONS</b>						
Maximum Offset Voltage over Temperature				0.5		mV
Offset Voltage Temperature Drift				0.25		$\mu\text{V}/^\circ\text{C}$
Input Bias Current				0.5	5	pA
<b>CROSSTALK</b>						
ADA4622-1/ADA4622-2	$C_S$	$R_L = 5 \text{ k}\Omega$ , $V_{IN} = 3 \text{ V p-p}$				
		f = 1 kHz		-112		dB
		f = 100 kHz		-72		dB
ADA4622-4	$C_S$	f = 1 kHz		-106		dB
		f = 100 kHz		-66		dB

## ABSOLUTE MAXIMUM RATINGS

Table 4.

Parameter	Rating
Supply Voltage	36 V
Input Voltage	(V-) -0.3 V to (V+) +0.2 V
Differential Input Voltage	36 V
Storage Temperature Range	-65°C to +150°C
Operating Temperature Range	-40°C to +125°C
Junction Temperature Range	-65°C to +150°C
Lead Temperature, Soldering (10 sec)	300°C
ESD Rating, Human Body Model (HBM)	4 kV

Stresses at or above those listed under Absolute Maximum Ratings may cause permanent damage to the product. This is a stress rating only; functional operation of the product at these or any other conditions above those indicated in the operational section of this specification is not implied. Operation beyond the maximum operating conditions for extended periods may affect product reliability.

## THERMAL RESISTANCE

Thermal performance is directly linked to printed circuit board (PCB) design and operating environment. Close attention to PCB thermal design is required.

Table 5. Thermal Resistance

Package Type <sup>1, 2</sup>	$\theta_{JA}$	$\theta_{JC}$ <sup>3</sup>	Unit
8-Lead SOIC_N			
1-Layer JEDEC Board	N/A	63	°C/W
2-Layer JEDEC Board	120	N/A	°C/W
8-Lead MSOP			
1-Layer JEDEC Board	N/A	115	°C/W
2-Layer JEDEC Board	185	N/A	°C/W
8-Lead LFCSP			
1-Layer JEDEC Board	N/A	63	°C/W
2-Layer JEDEC Board	145	N/A	°C/W
2-Layer JEDEC Board with 2 × 2 Vias	55	N/A	°C/W
5-Lead SOT-23			
1-Layer JEDEC Board	N/A	82	°C/W
2-Layer JEDEC Board	339	N/A	°C/W
14-Lead SOIC_N			
1-Layer JEDEC Board	N/A	42	°C/W
2-Layer JEDEC Board	72	N/A	°C/W
16-Lead, 4 × 4 mm LFCSP			
1-Layer JEDEC Board	N/A	2.2	°C/W
2-Layer JEDEC Board	48	N/A	°C/W

<sup>1</sup> Thermal impedance simulated values are based on a JEDEC thermal test board. See JEDEC JESD51.

<sup>2</sup> N/A means not applicable.

<sup>3</sup> For  $\theta_{JC}$  test, 100  $\mu\text{m}$  thermal interface material (TIM) is used. TIM is assumed to have 3.6 W/mK.

## ESD CAUTION



**ESD (electrostatic discharge) sensitive device.** Charged devices and circuit boards can discharge without detection. Although this product features patented or proprietary protection circuitry, damage may occur on devices subjected to high energy ESD. Therefore, proper ESD precautions should be taken to avoid performance degradation or loss of functionality.

PIN CONFIGURATIONS AND FUNCTION DESCRIPTIONS

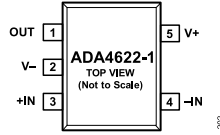
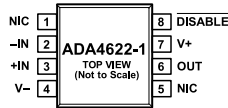


Figure 2. 5-Lead SOT-23 Pin Configuration, ADA4622-1

Table 6. 5-Lead SOT-23 Pin Function Descriptions, ADA4622-1

Pin No.	Mnemonic	Description
1	OUT	Output.
2	V-	Negative Supply Voltage.
3	+IN	Noninverting Input.
4	-IN	Inverting Input.
5	V+	Positive Supply Voltage.



NOTES  
 1. NIC = NOT INTERNALLY CONNECTED.

Figure 3. 8-Lead SOIC\_N Pin Configuration, ADA4622-1

Table 7. 8-Lead SOIC\_N Pin Function Descriptions, ADA4622-1

Pin No.	Mnemonic	Description
1, 5	NIC	Not Internally Connected.
2	-IN	Inverting Input.
3	+IN	Noninverting Input.
4	V-	Negative Supply Voltage.
6	OUT	Output.
7	V+	Positive Supply Voltage.
8	DISABLE	Disable Input (Active Low).

PIN CONFIGURATIONS AND FUNCTION DESCRIPTIONS

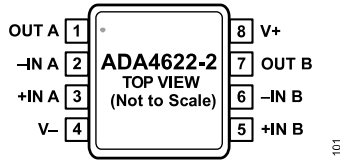


Figure 4. 8-Lead MSOP Pin Configuration, ADA4622-2

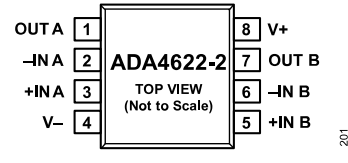


Figure 5. 8-Lead SOIC\_N Pin Configuration, ADA4622-2

Table 8. 8-Lead MSOP and 8-Lead SOIC\_N Pin Function Descriptions, ADA4622-2

Pin No.	Mnemonic	Description
1	OUT A	Output, Channel A.
2	-IN A	Inverting Input, Channel A.
3	+IN A	Noninverting Input, Channel A.
4	V-	Negative Supply Voltage.
5	+IN B	Noninverting Input, Channel B.
6	-IN B	Inverting Input, Channel B.
7	OUT B	Output, Channel B.
8	V+	Positive Supply Voltage.

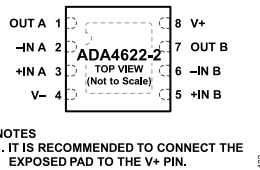
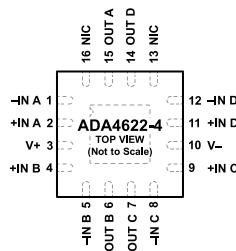


Figure 6. 8-Lead LFCSP Pin Configuration, ADA4622-2

Table 9. 8-Lead LFCSP Pin Function Descriptions, ADA4622-2

Pin No.	Mnemonic	Description
1	OUT A	Output, Channel A.
2	-IN A	Inverting Input, Channel A.
3	+IN A	Noninverting Input, Channel A.
4	V-	Negative Supply Voltage.
5	+IN B	Noninverting Input, Channel B.
6	-IN B	Inverting Input, Channel B.
7	OUT B	Output, Channel B.
8	V+	Positive Supply Voltage.
	EPAD	Exposed Pad. It is recommended to connect the exposed pad to the V+ pin.



NOTES  
1. NIC = NOT INTERNALLY CONNECTED.  
2. THE EXPOSED PAD MUST BE CONNECTED TO V+.

Figure 7. 16-Lead LFCSP Pin Configuration, ADA4622-4

## PIN CONFIGURATIONS AND FUNCTION DESCRIPTIONS

Table 10. 16-Lead LFCSP Pin Function Descriptions, ADA4622-4

Pin No.	Mnemonic	Description
1	-IN A	Inverting Input, Channel A.
2	+IN A	Noninverting Input, Channel A.
3	V+	Positive Supply Voltage.
4	+IN B	Noninverting Input, Channel B.
5	-IN B	Inverting Input, Channel B.
6	OUT B	Output, Channel B.
7	OUT C	Output, Channel C.
8	-IN C	Inverting Input, Channel C.
9	+IN C	Noninverting Input, Channel C.
10	V-	Negative Supply Voltage.
11	+IN D	Noninverting Input, Channel D.
12	-IN D	Inverting Input, Channel D.
13, 16	NIC	Not Internally Connected.
14	OUT D	Output, Channel D.
15	OUT A	Output, Channel A.
	EPAD	Exposed Pad. The exposed pad must be connected to the V+ pin.

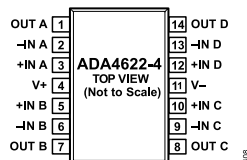


Figure 8. 14-Lead SOIC\_N Pin Configuration, ADA4622-4

Table 11. 14-Lead SOIC\_N Pin Function Descriptions, ADA4622-4

Pin No.	Mnemonic	Description
1	OUT A	Output, Channel A.
2	-IN A	Inverting Input, Channel A.
3	+IN A	Noninverting Input, Channel A.
4	V+	Positive Supply Voltage.
5	+IN B	Noninverting Input, Channel B.
6	-IN B	Inverting Input, Channel B.
7	OUT B	Output, Channel B.
8	OUT C	Output, Channel C.
9	-IN C	Inverting Input, Channel C.
10	+IN C	Noninverting Input, Channel C.
11	V-	Negative Supply Voltage.
12	+IN D	Noninverting Input, Channel D.
13	-IN D	Inverting Input, Channel D.
14	OUT D	Output, Channel D.

TYPICAL PERFORMANCE CHARACTERISTICS

T<sub>A</sub> = 25°C, unless otherwise noted.

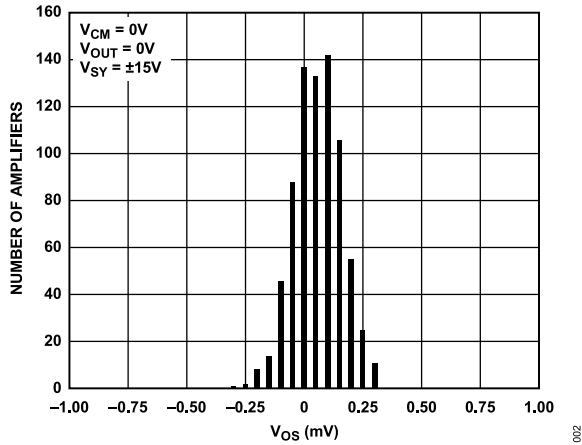


Figure 9. Input Offset Voltage ( $V_{OS}$ ) Distribution,  $V_{SY} = \pm 15V$

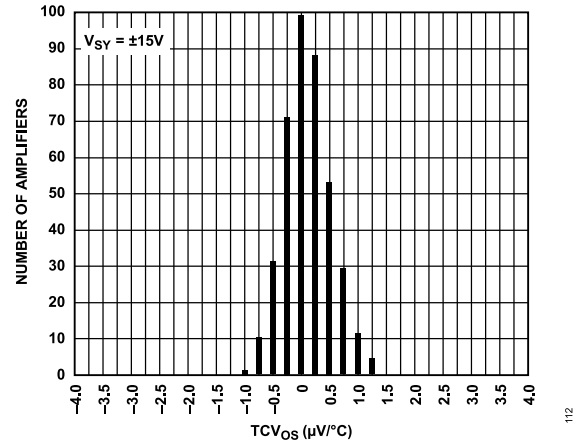


Figure 12. Input Offset Voltage Drift ( $TCV_{OS}$ ) Distribution ( $-40^{\circ}C$  to  $+125^{\circ}C$ ),  $V_{SY} = \pm 15V$

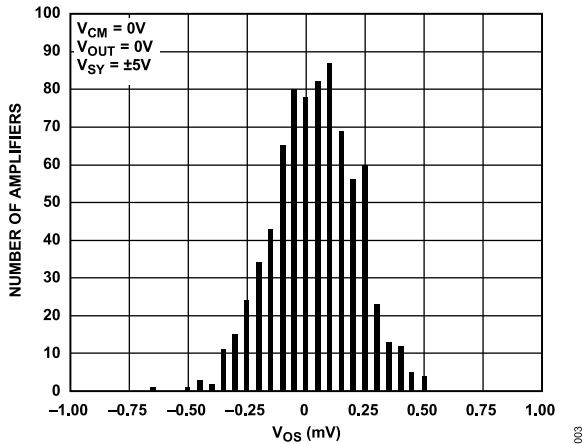


Figure 10. Input Offset Voltage ( $V_{OS}$ ) Distribution,  $V_{SY} = \pm 5V$

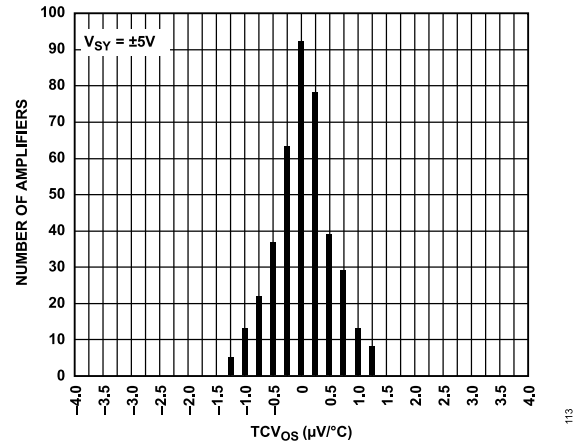


Figure 13. Input Offset Voltage Drift ( $TCV_{OS}$ ) Distribution ( $-40^{\circ}C$  to  $+125^{\circ}C$ ),  $V_{SY} = \pm 5V$

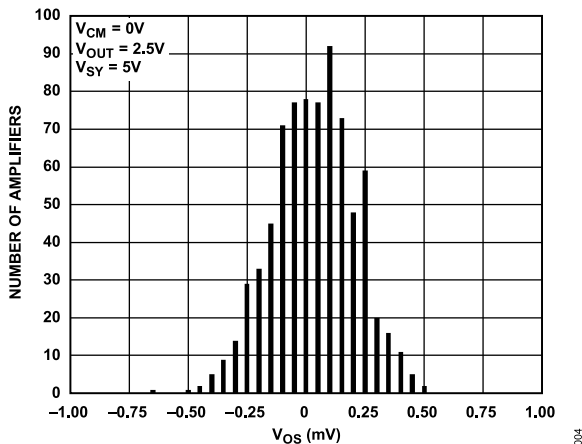


Figure 11. Input Offset Voltage ( $V_{OS}$ ) Distribution,  $V_{SY} = 5V$

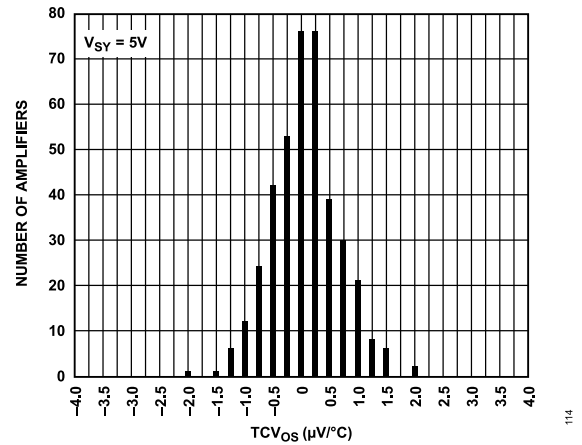


Figure 14. Input Offset Voltage Drift ( $TCV_{OS}$ ) Distribution ( $-40^{\circ}C$  to  $+125^{\circ}C$ ),  $V_{SY} = 5V$

TYPICAL PERFORMANCE CHARACTERISTICS

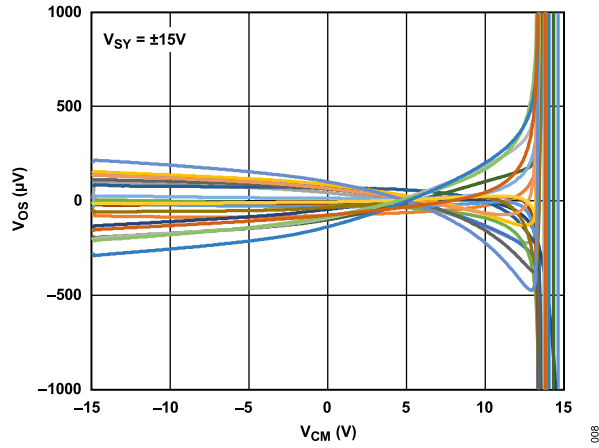


Figure 15. Input Offset Voltage ( $V_{OS}$ ) vs. Common-Mode Voltage ( $V_{CM}$ ),  $V_{SY} = \pm 15\text{ V}$

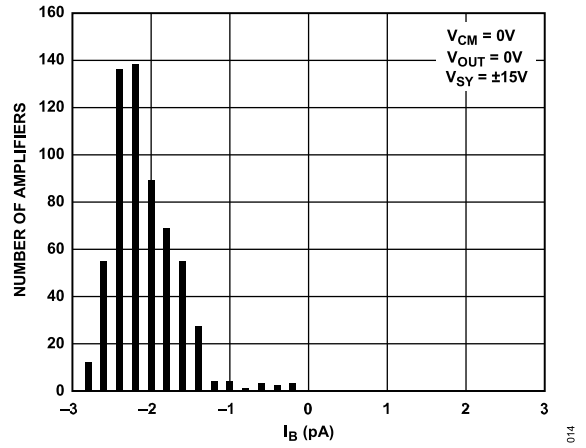


Figure 18. Input Bias Current ( $I_B$ ) Distribution,  $V_{SY} = \pm 15\text{ V}$

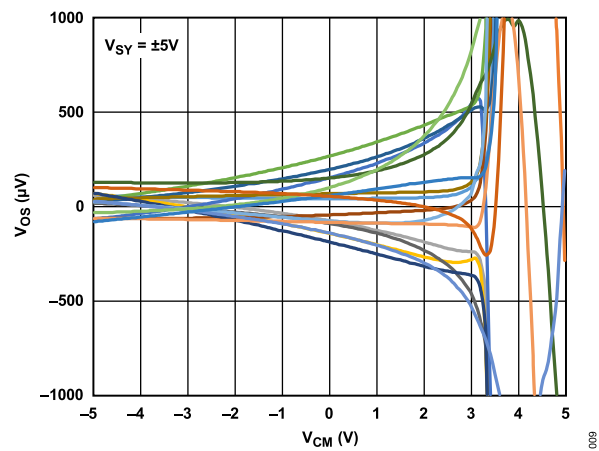


Figure 16. Input Offset Voltage ( $V_{OS}$ ) vs. Common-Mode Voltage ( $V_{CM}$ ),  $V_{SY} = \pm 5\text{ V}$

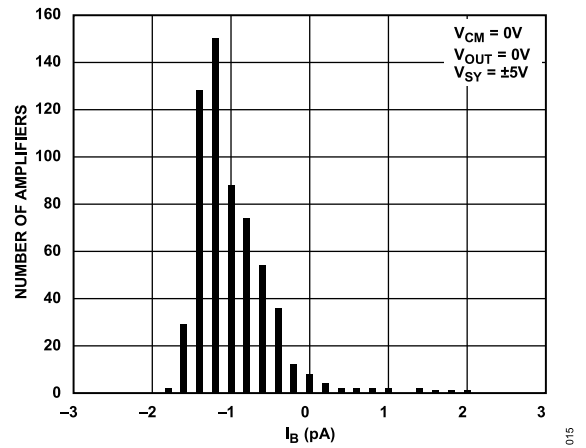


Figure 19. Input Bias Current ( $I_B$ ) Distribution,  $V_{SY} = \pm 5\text{ V}$

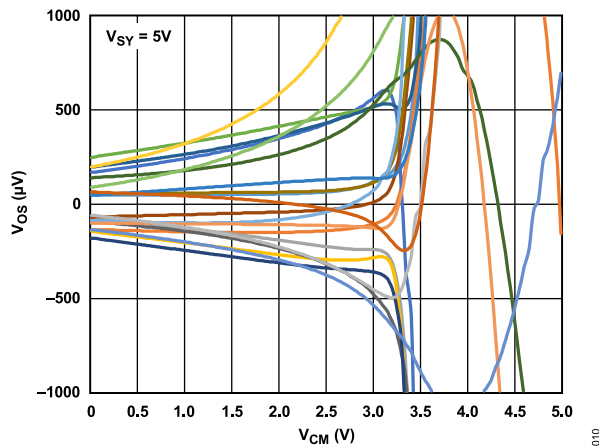


Figure 17. Input Offset Voltage ( $V_{OS}$ ) vs. Common-Mode Voltage ( $V_{CM}$ ),  $V_{SY} = 5\text{ V}$

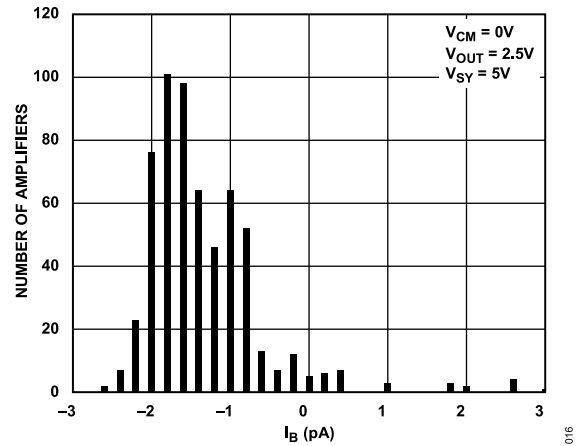


Figure 20. Input Bias Current ( $I_B$ ) Distribution,  $V_{SY} = 5\text{ V}$

TYPICAL PERFORMANCE CHARACTERISTICS

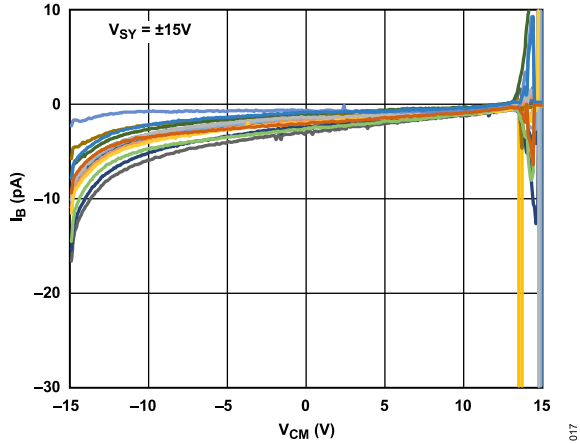


Figure 21. Input Bias Current ( $I_B$ ) vs. Input Common-Mode Voltage ( $V_{CM}$ ),  $V_{SY} = \pm 15\text{ V}$

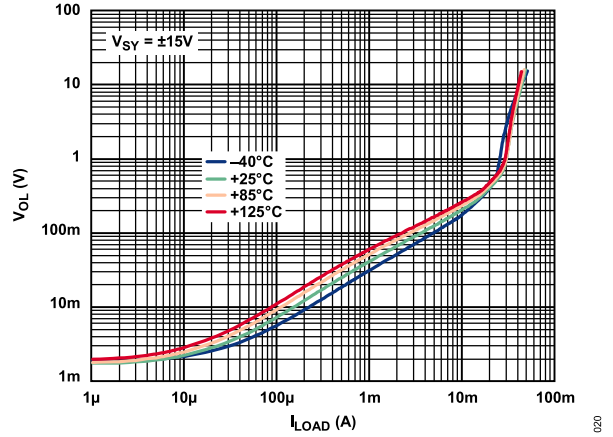


Figure 24. Output Voltage Low ( $V_{OL}$ ) to Supply Rail vs. Load Current ( $I_{LOAD}$ ) over Temperature,  $V_{SY} = \pm 15\text{ V}$

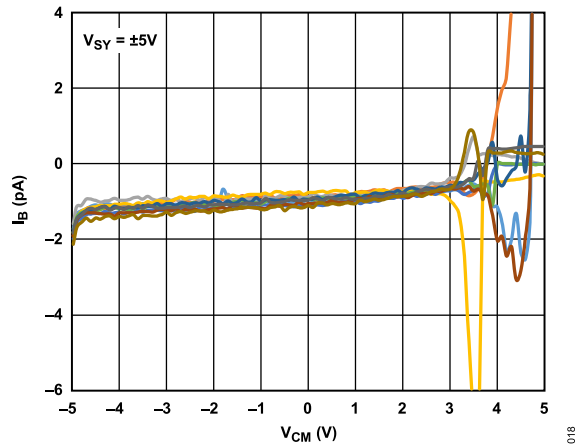


Figure 22. Input Bias Current ( $I_B$ ) vs. Input Common-Mode Voltage ( $V_{CM}$ ),  $V_{SY} = \pm 5\text{ V}$

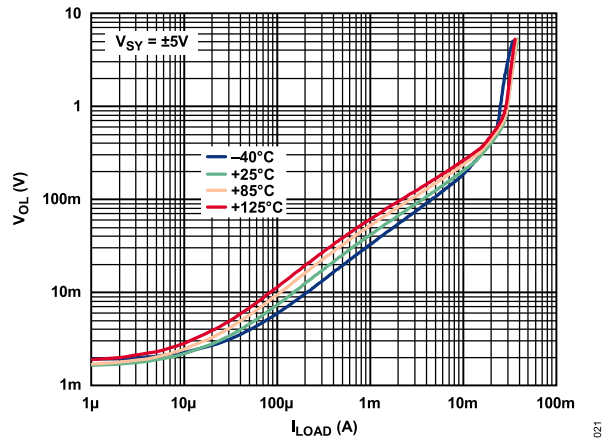


Figure 25. Output Voltage Low ( $V_{OL}$ ) to Supply Rail vs. Load Current ( $I_{LOAD}$ ) over Temperature,  $V_{SY} = \pm 5\text{ V}$

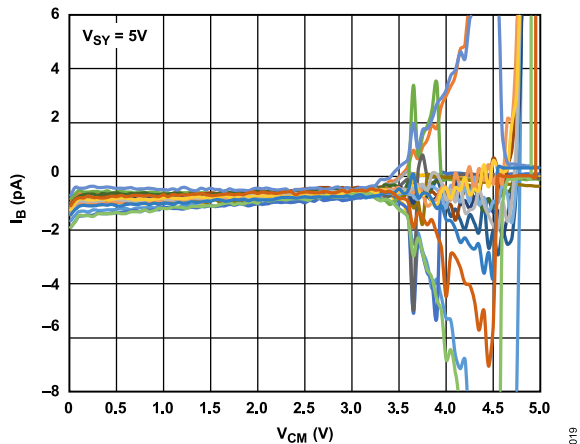


Figure 23. Input Bias Current ( $I_B$ ) vs. Input Common-Mode Voltage ( $V_{CM}$ ),  $V_{SY} = 5\text{ V}$

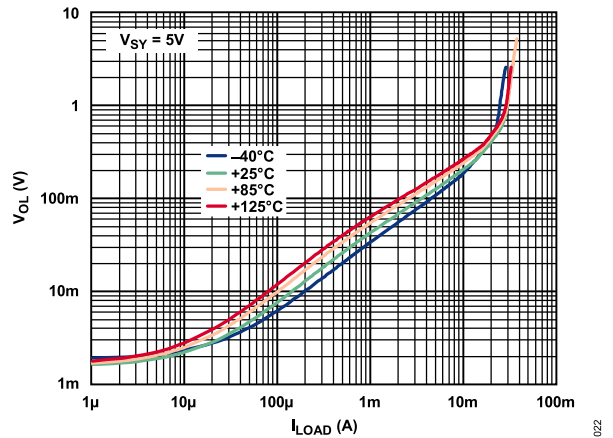


Figure 26. Output Voltage Low ( $V_{OL}$ ) to Supply Rail vs. Load Current ( $I_{LOAD}$ ) over Temperature,  $V_{SY} = 5\text{ V}$



TYPICAL PERFORMANCE CHARACTERISTICS

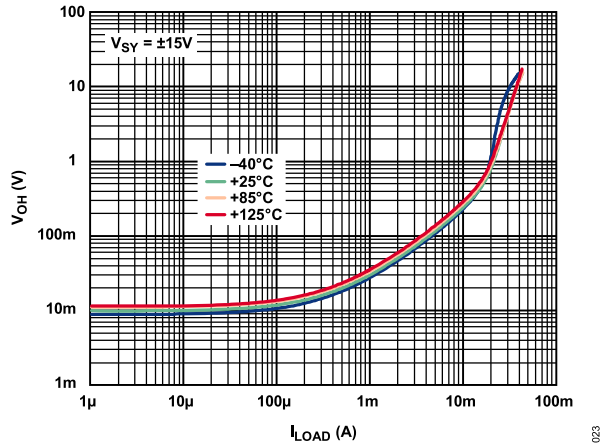


Figure 27. Output Voltage High ( $V_{OH}$ ) to Supply Rail vs. Load Current ( $I_{LOAD}$ ) over Temperature,  $V_{SY} = \pm 15\text{ V}$

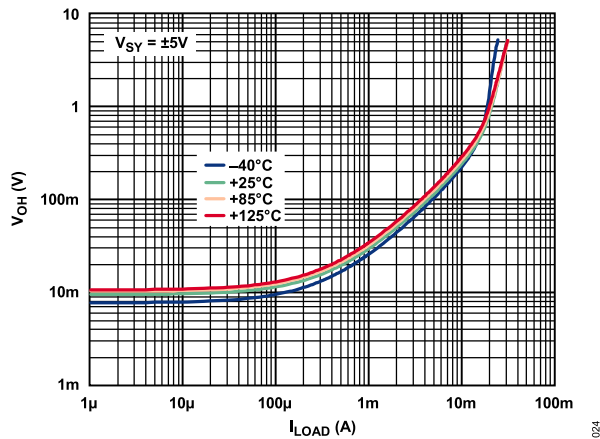


Figure 28. Output Voltage High ( $V_{OH}$ ) to Supply Rail vs. Load Current ( $I_{LOAD}$ ) over Temperature,  $V_{SY} = \pm 5\text{ V}$

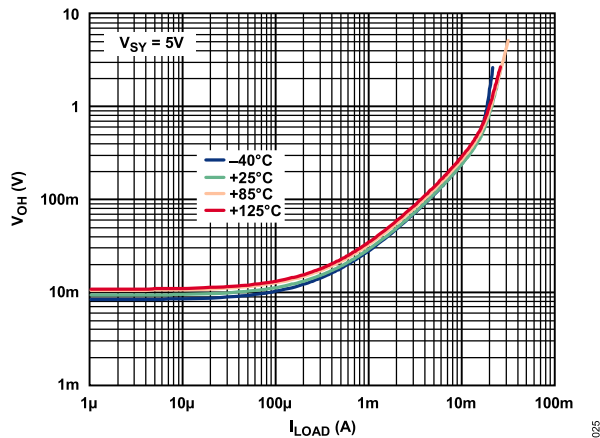


Figure 29. Output Voltage High ( $V_{OH}$ ) to Supply Rail vs. Load Current ( $I_{LOAD}$ ) over Temperature,  $V_{SY} = 5\text{ V}$

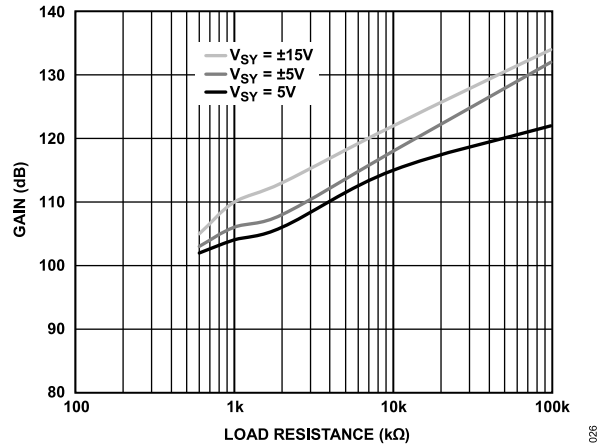


Figure 30. Open-Loop Voltage Gain ( $A_{VO}$ ) vs. Load Resistance

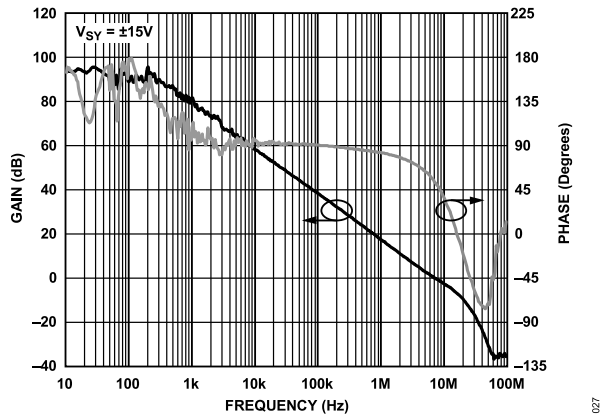


Figure 31. Open-Loop Voltage Gain ( $A_{VO}$ ) and Phase vs. Frequency,  $V_{SY} = \pm 15\text{ V}$

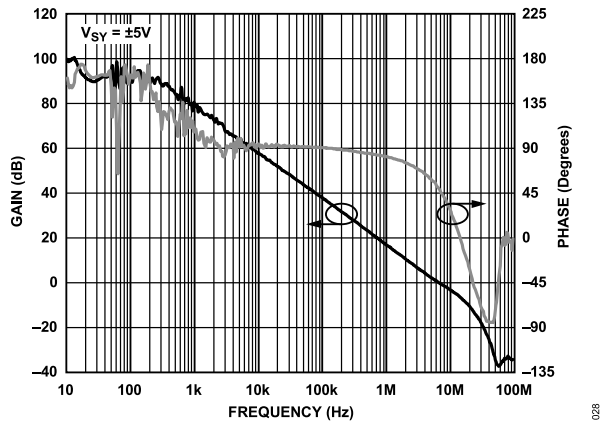


Figure 32. Open-Loop Voltage Gain ( $A_{VO}$ ) and Phase vs. Frequency,  $V_{SY} = \pm 5\text{ V}$

TYPICAL PERFORMANCE CHARACTERISTICS

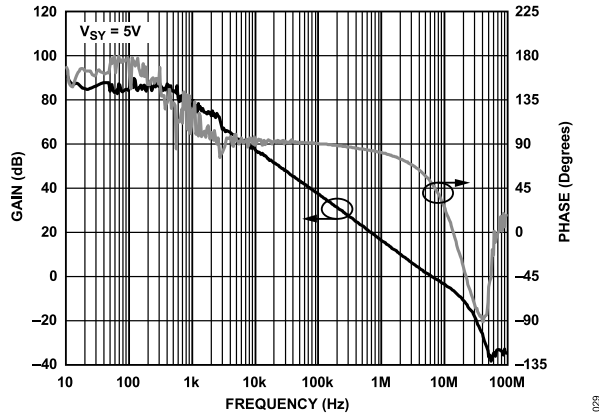


Figure 33. Open-Loop Voltage Gain ( $A_{VO}$ ) and Phase vs. Frequency,  $V_{SY} = 5\text{ V}$

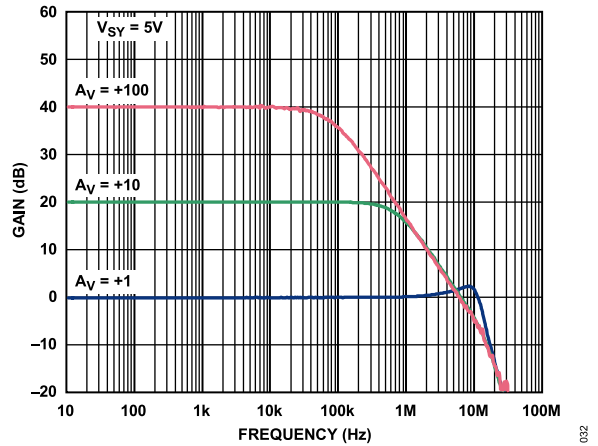


Figure 36. Closed-Loop Gain ( $A_V$ ) vs. Frequency,  $V_{SY} = 5\text{ V}$

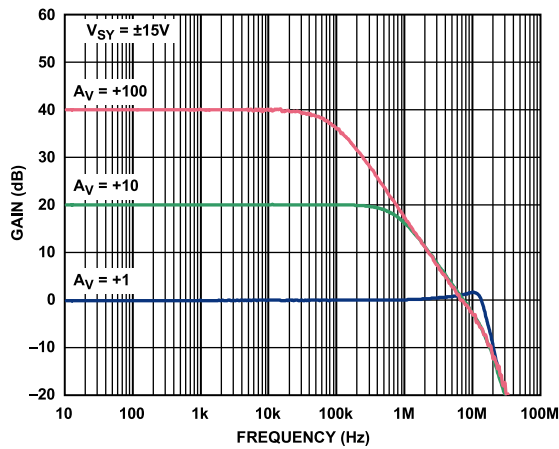


Figure 34. Closed-Loop Gain ( $A_V$ ) vs. Frequency,  $V_{SY} = \pm 15\text{ V}$

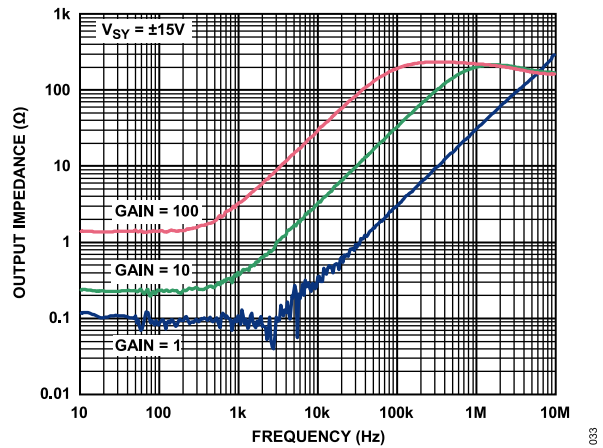


Figure 37. Output Impedance vs. Frequency,  $V_{SY} = \pm 15\text{ V}$

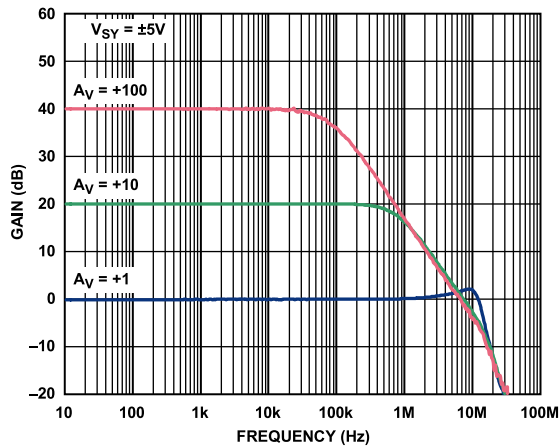


Figure 35. Closed-Loop Gain ( $A_V$ ) vs. Frequency,  $V_{SY} = \pm 5\text{ V}$

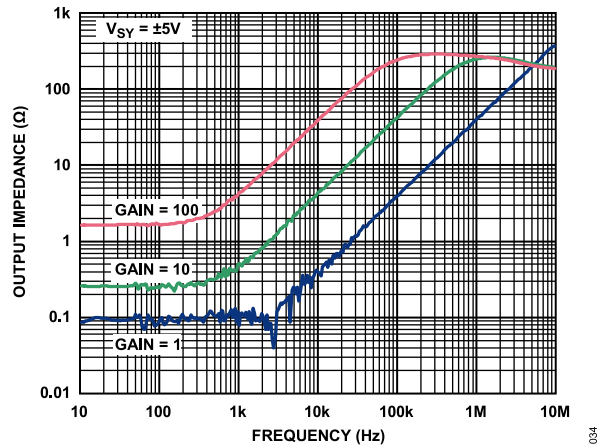


Figure 38. Output Impedance vs. Frequency,  $V_{SY} = \pm 5\text{ V}$

TYPICAL PERFORMANCE CHARACTERISTICS

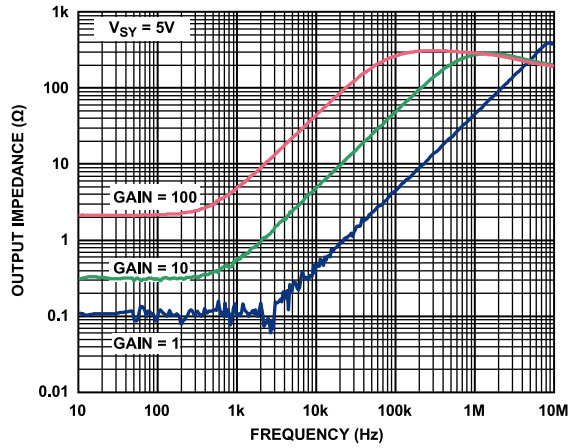


Figure 39. Output Impedance vs. Frequency,  $V_{SY} = 5\text{ V}$

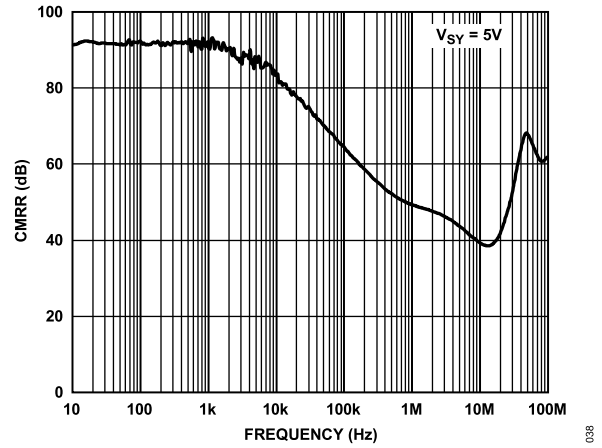


Figure 42. CMRR vs. Frequency,  $V_{SY} = 5\text{ V}$

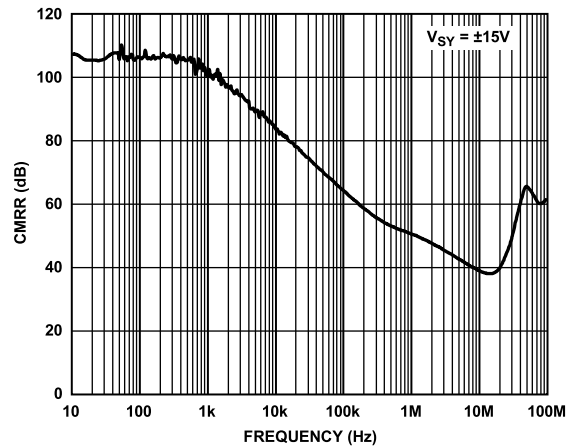


Figure 40. CMRR vs. Frequency,  $V_{SY} = \pm 15\text{ V}$

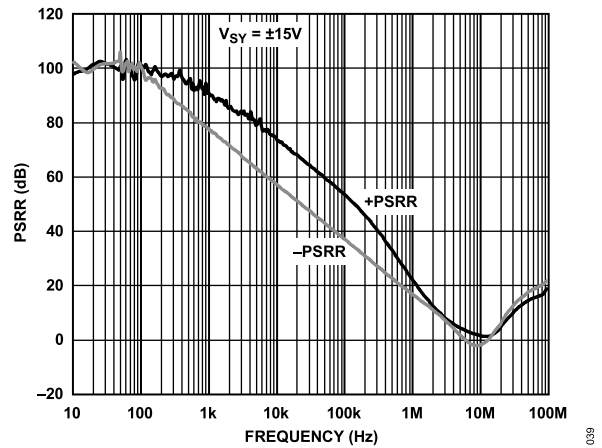


Figure 43. PSRR vs. Frequency,  $V_{SY} = \pm 15\text{ V}$

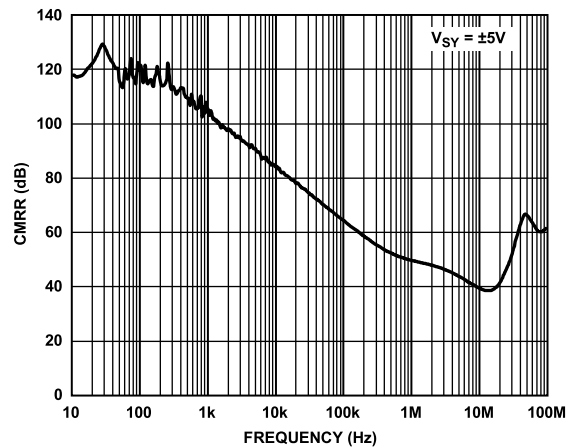


Figure 41. CMRR vs. Frequency,  $V_{SY} = \pm 5\text{ V}$

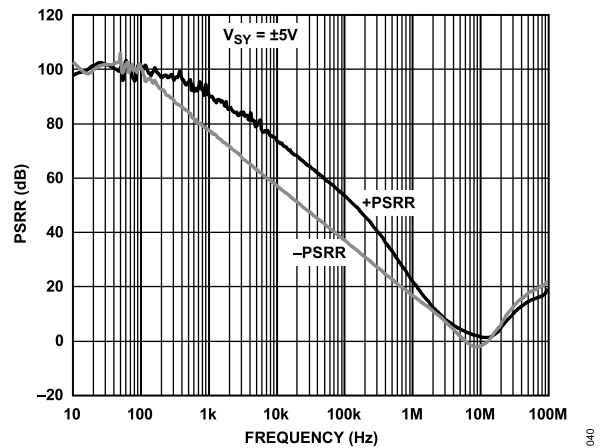


Figure 44. PSRR vs. Frequency,  $V_{SY} = \pm 5\text{ V}$

TYPICAL PERFORMANCE CHARACTERISTICS

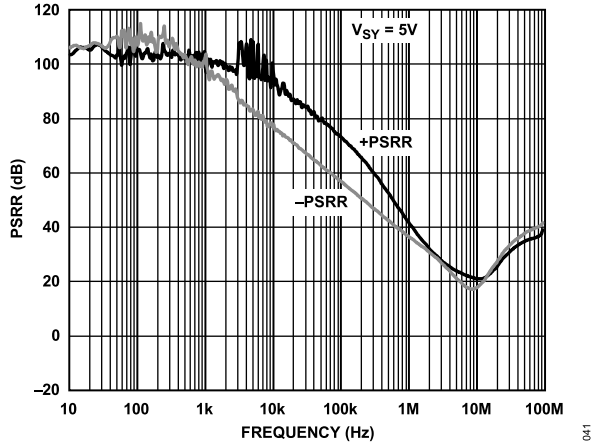


Figure 45. PSRR vs. Frequency,  $V_{SY} = 5\text{ V}$

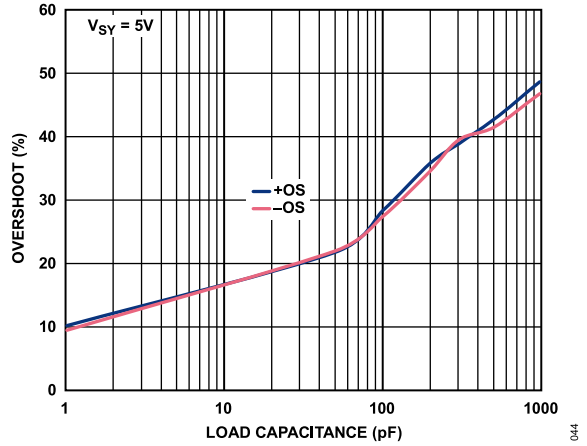


Figure 48. Small Signal Overshoot (OS) vs. Load Capacitance,  $V_{SY} = 5\text{ V}$

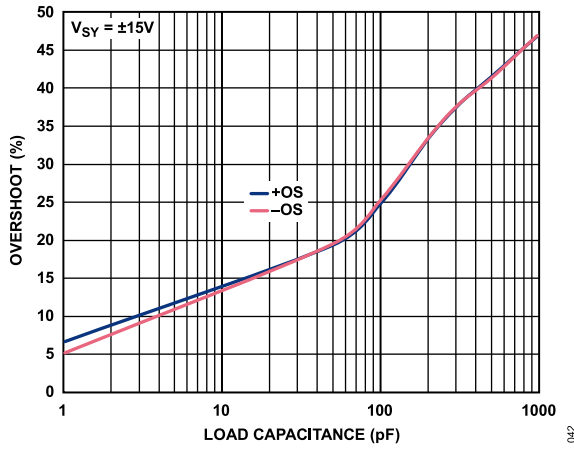


Figure 46. Small Signal Overshoot (OS) vs. Load Capacitance,  $V_{SY} = \pm 15\text{ V}$

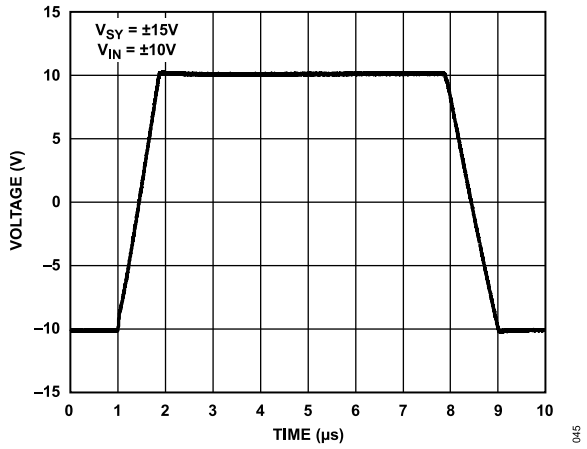


Figure 49. Large Signal Transient Response,  $V_{SY} = \pm 15\text{ V}$

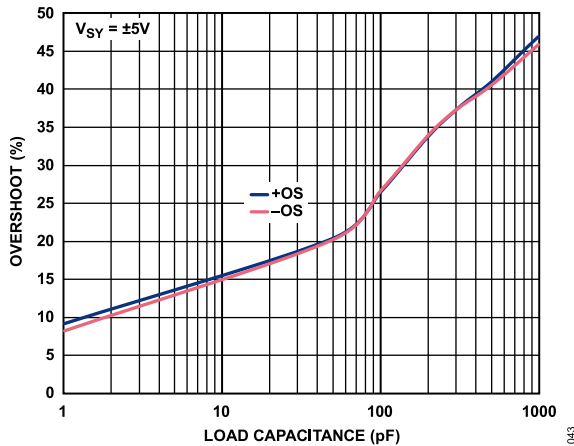


Figure 47. Small Signal Overshoot (OS) vs. Load Capacitance,  $V_{SY} = \pm 5\text{ V}$

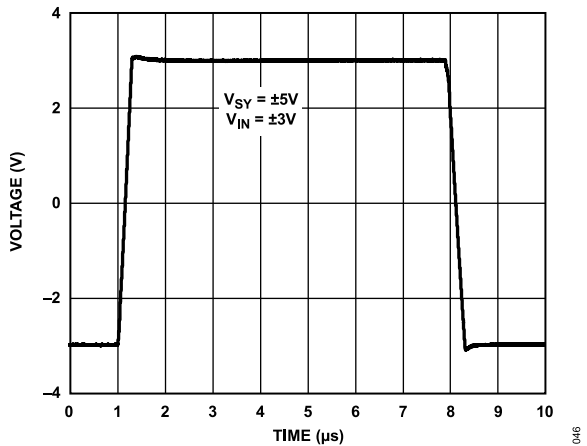


Figure 50. Large Signal Transient Response,  $V_{SY} = \pm 5\text{ V}$

TYPICAL PERFORMANCE CHARACTERISTICS

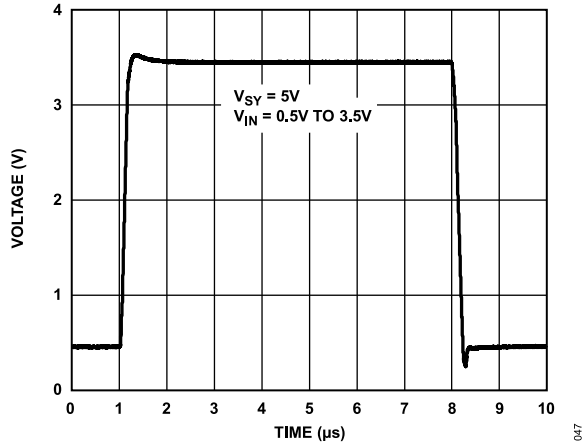


Figure 51. Large Signal Transient Response,  $V_{SY} = 5 V$

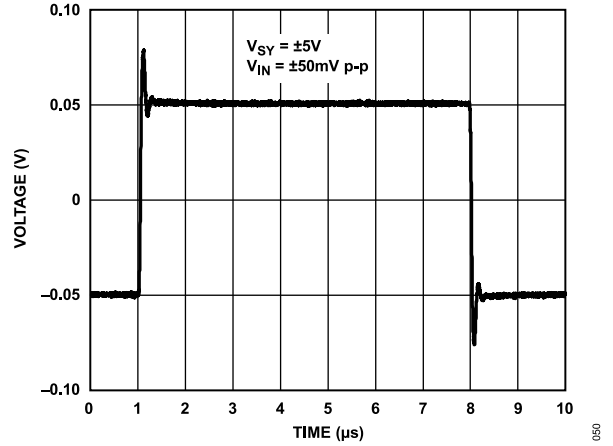


Figure 54. Small Signal Transient Response,  $V_{SY} = \pm 5 V$

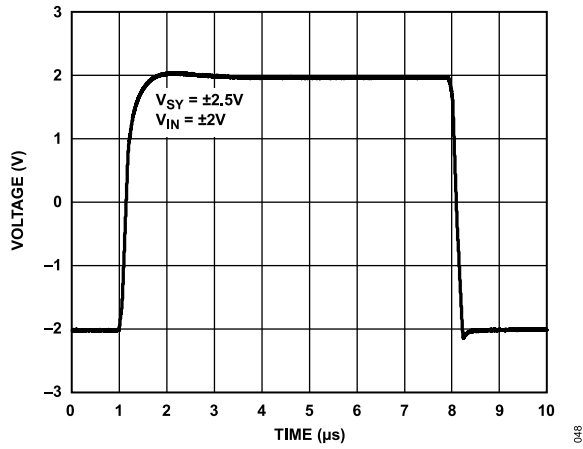


Figure 52. Large Signal Transient Response,  $V_{SY} = \pm 2.5 V$

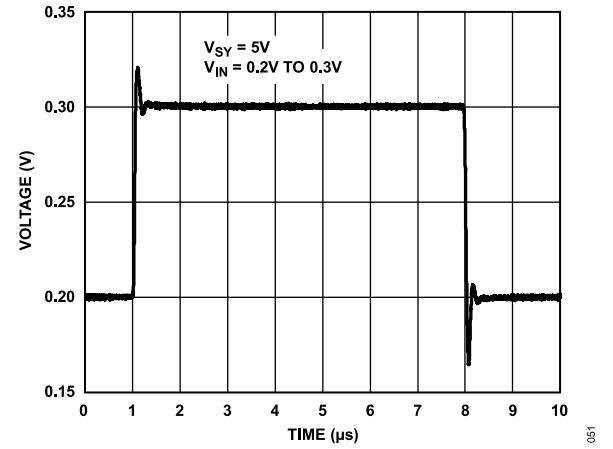


Figure 55. Small Signal Transient Response,  $V_{SY} = 5 V$

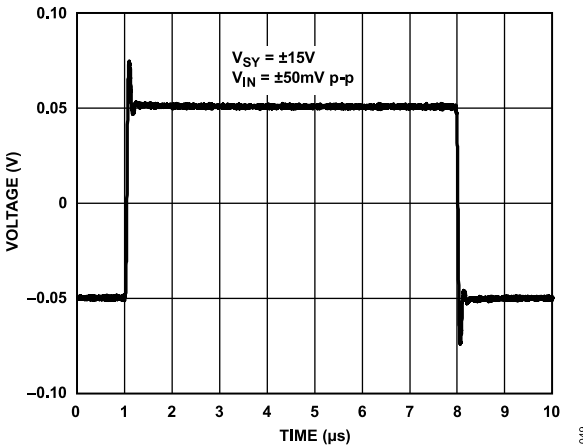


Figure 53. Small Signal Transient Response,  $V_{SY} = \pm 15 V$

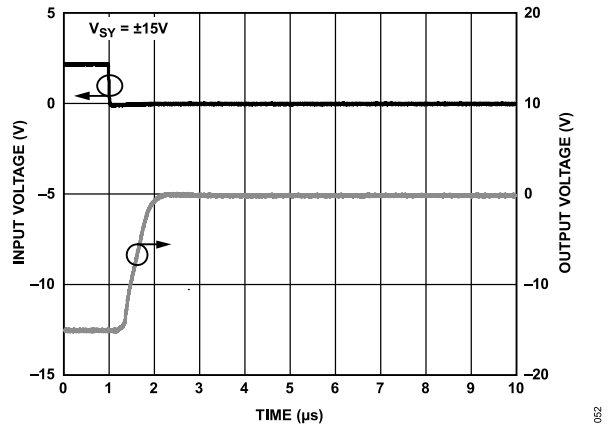


Figure 56. Negative Overload Recovery,  $A_V = -10$ ,  $V_{SY} = \pm 15 V$

TYPICAL PERFORMANCE CHARACTERISTICS

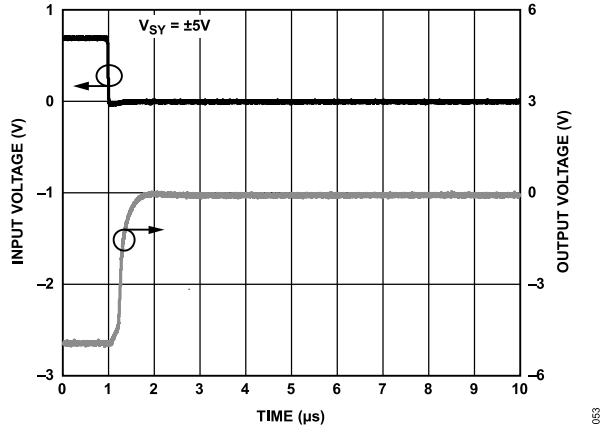


Figure 57. Negative Overload Recovery,  $A_V = -10$ ,  $V_{SV} = \pm 5V$

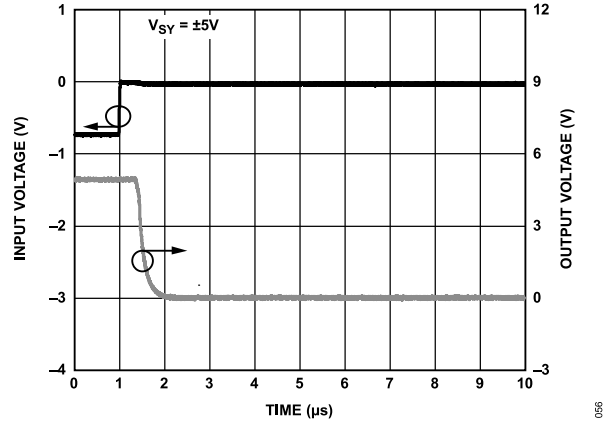


Figure 60. Positive Overload Recovery,  $A_V = -10$ ,  $V_{SV} = \pm 5V$

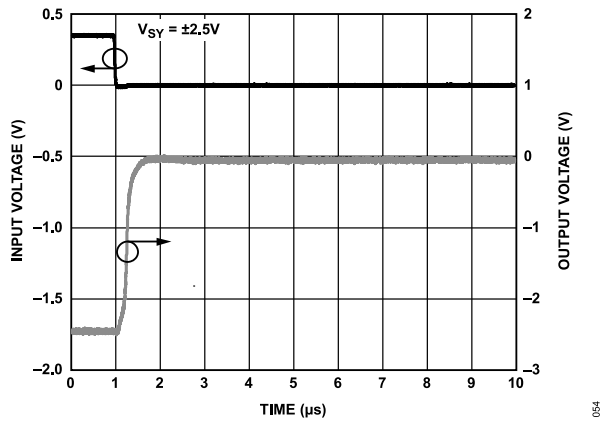


Figure 58. Negative Overload Recovery,  $A_V = -10$ ,  $V_{SV} = \pm 2.5V$

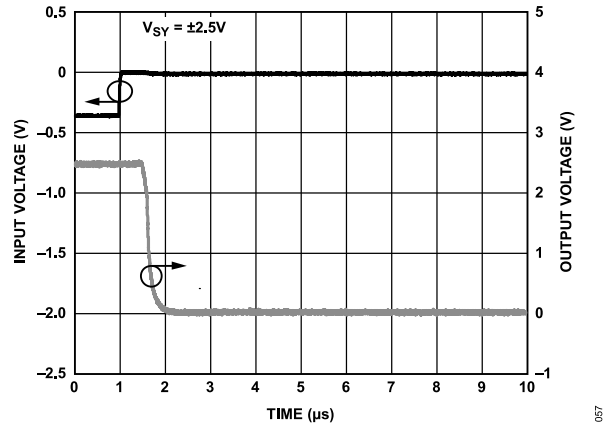


Figure 61. Positive Overload Recovery,  $A_V = -10$ ,  $V_{SV} = \pm 2.5V$

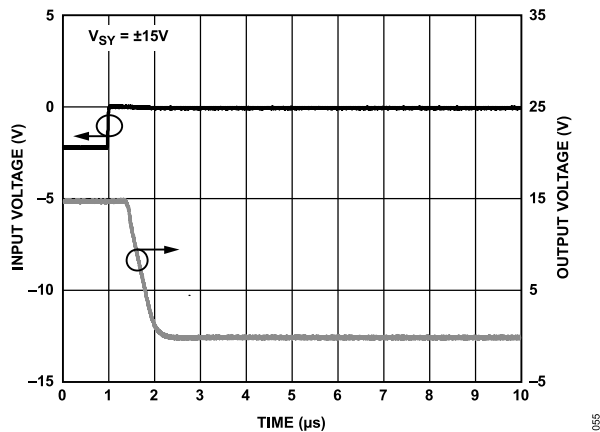


Figure 59. Positive Overload Recovery,  $A_V = -10$ ,  $V_{SV} = \pm 15V$

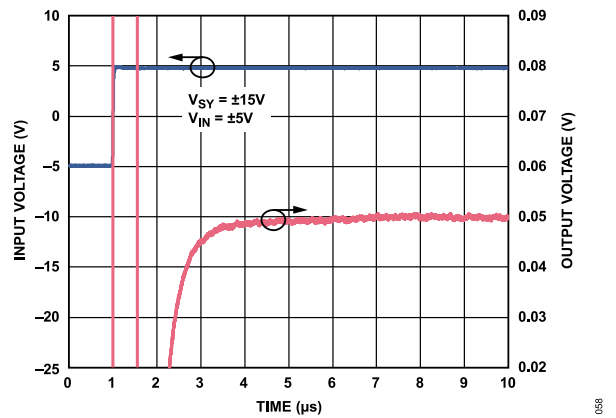


Figure 62. Positive Settling Time,  $A_V = -10$ ,  $V_{SV} = \pm 15V$

TYPICAL PERFORMANCE CHARACTERISTICS

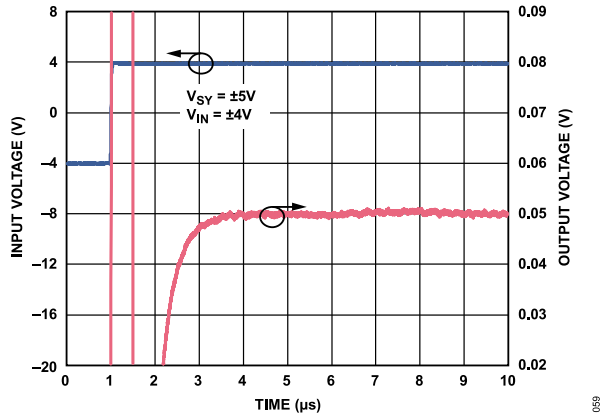


Figure 63. Positive Settling Time,  $A_V = -10$ ,  $V_{SY} = \pm 5 V$

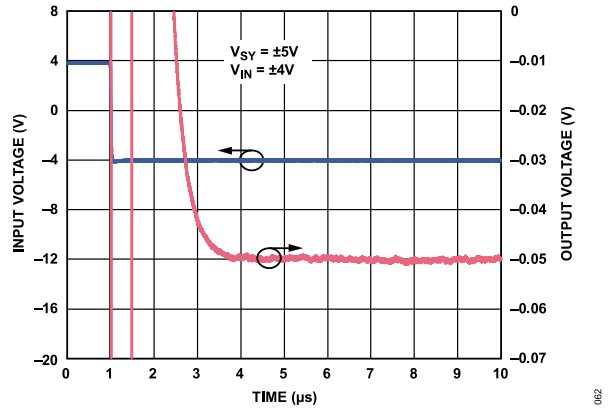


Figure 66. Negative Settling Time,  $A_V = -10$ ,  $V_{SY} = \pm 5 V$

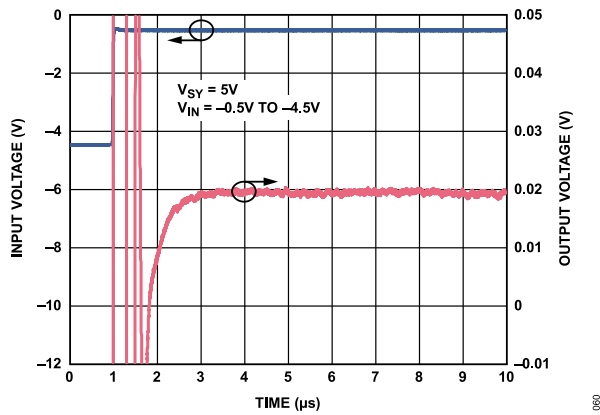


Figure 64. Positive Settling Time,  $A_V = -10$ ,  $V_{SY} = 5 V$

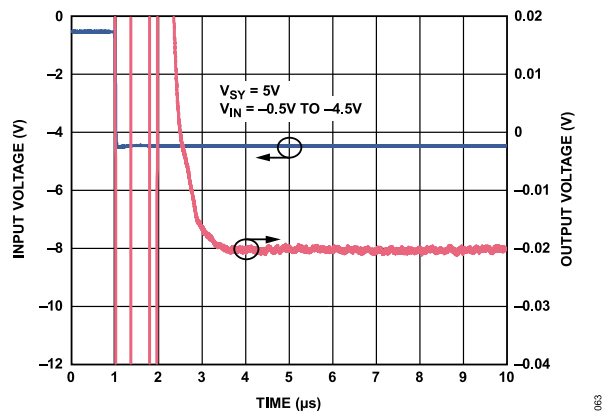


Figure 67. Negative Settling Time,  $A_V = -10$ ,  $V_{SY} = 5 V$

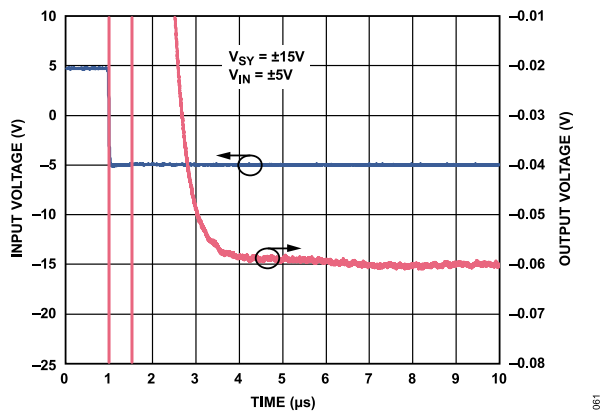


Figure 65. Negative Settling Time,  $A_V = -10$ ,  $V_{SY} = \pm 15 V$

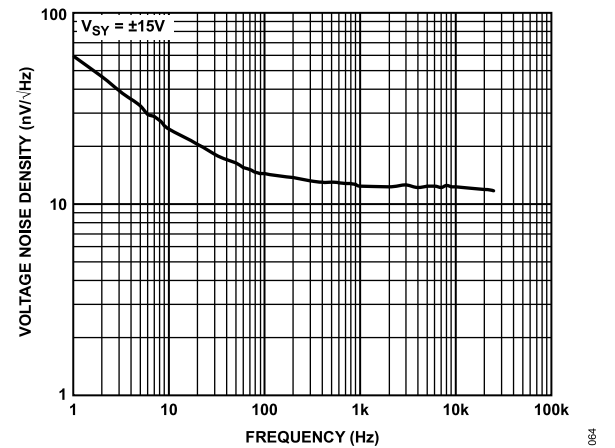


Figure 68. Voltage Noise Density,  $V_{SY} = \pm 15 V$

TYPICAL PERFORMANCE CHARACTERISTICS

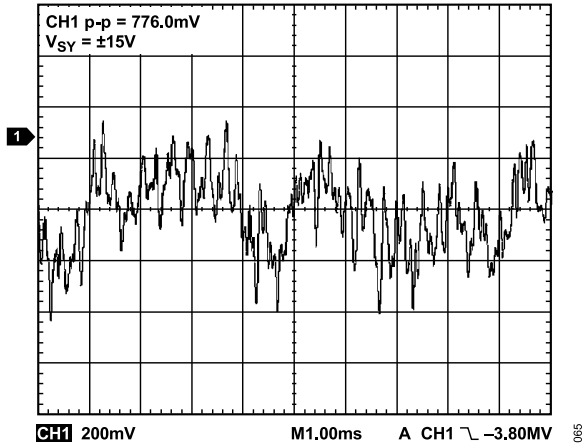


Figure 69. 0.1 Hz to 10 Hz Noise,  $V_{SY} = \pm 15 V$ , Gain = 1 Million

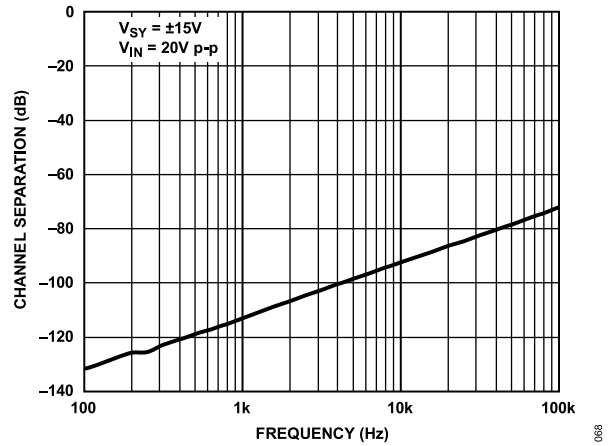


Figure 72. Channel Separation vs. Frequency,  $V_{SY} = \pm 15 V$

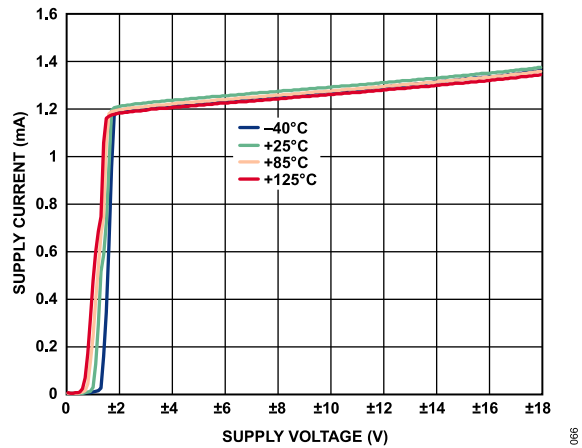


Figure 70. Supply Current ( $I_{SY}$ ) vs. Supply Voltage ( $V_{SY}$ ) for Various Temperatures (ADA4622-2)

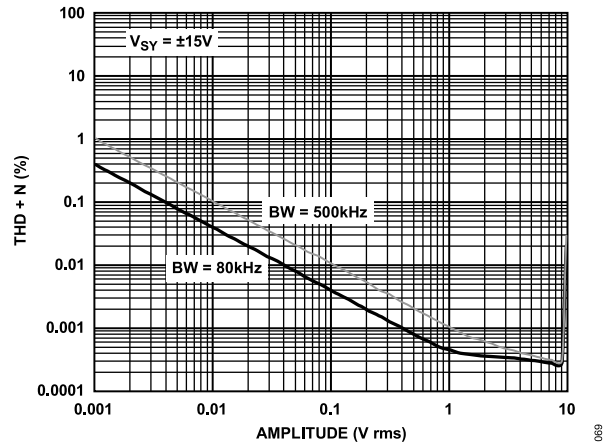


Figure 73. THD + N vs. Amplitude,  $V_{SY} = \pm 15 V$

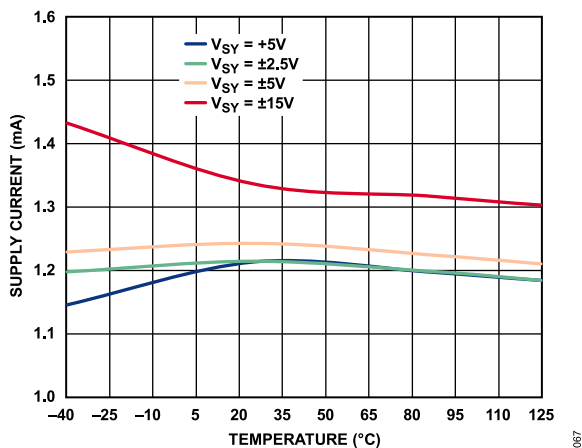


Figure 71. Supply Current ( $I_{SY}$ ) vs. Temperature for Various Supply Voltages (ADA4622-2)

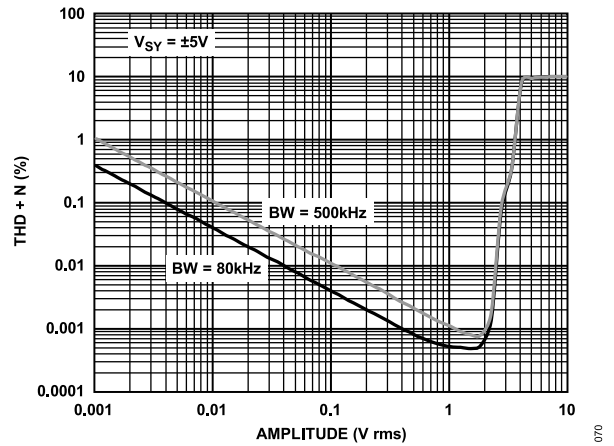


Figure 74. THD + N vs. Amplitude,  $V_{SY} = \pm 5 V$



TYPICAL PERFORMANCE CHARACTERISTICS

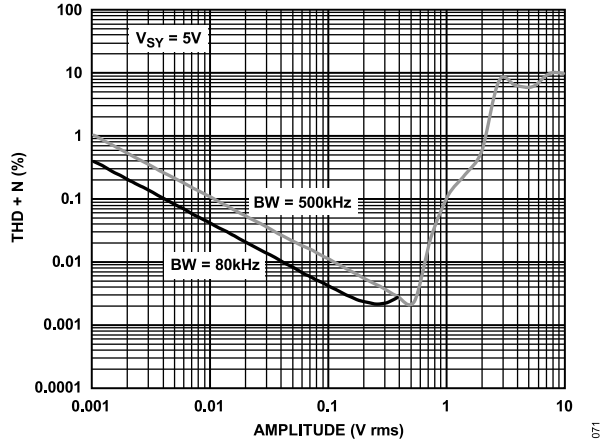


Figure 75. THD + N vs. Amplitude,  $V_{SY} = 5\text{ V}$

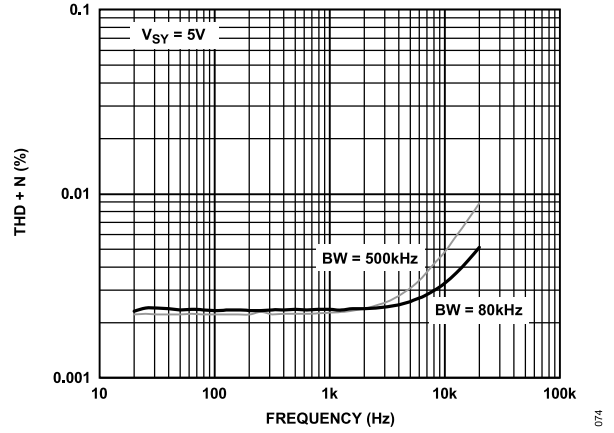


Figure 78. THD + N vs. Frequency,  $V_{SY} = 5\text{ V}$

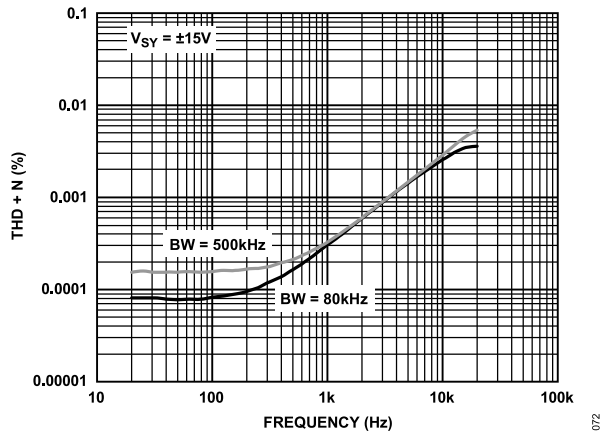


Figure 76. THD + N vs. Frequency,  $V_{SY} = \pm 15\text{ V}$

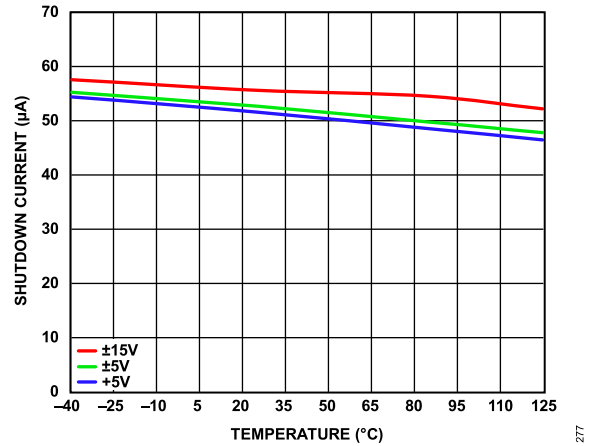


Figure 79. Shutdown Current vs. Temperature

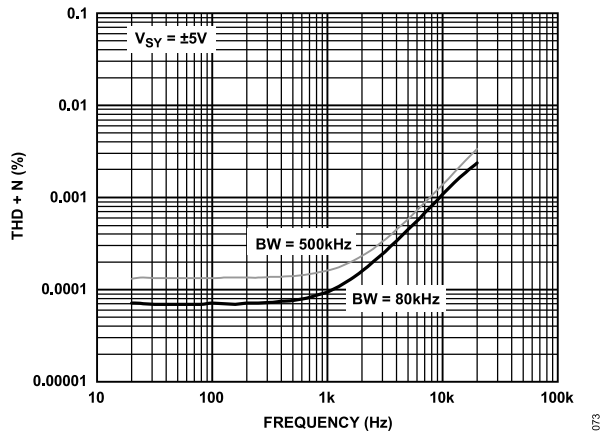


Figure 77. THD + N vs. Frequency,  $V_{SY} = \pm 5\text{ V}$

THEORY OF OPERATION

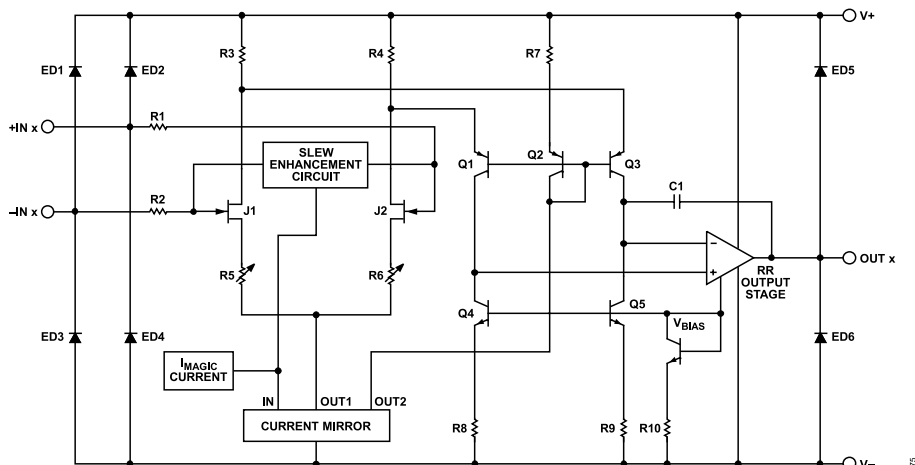


Figure 80. Simplified Circuit Diagram

INPUT CHARACTERISTICS

The ADA4622-1/ADA4622-2/ADA4622-4 input stage consists of N-channel JFETs that provide low offset, low noise, and high impedance. The minimum input common-mode voltage extends from  $-0.2\text{ mV}$  below  $V^-$  to  $1\text{ V}$  less than  $V^+$ . Driving the input closer to the positive rail causes loss of amplifier bandwidth and increased common-mode voltage error. Figure 81 shows the rounding of the output due to the loss of bandwidth. The input and output are superimposed.

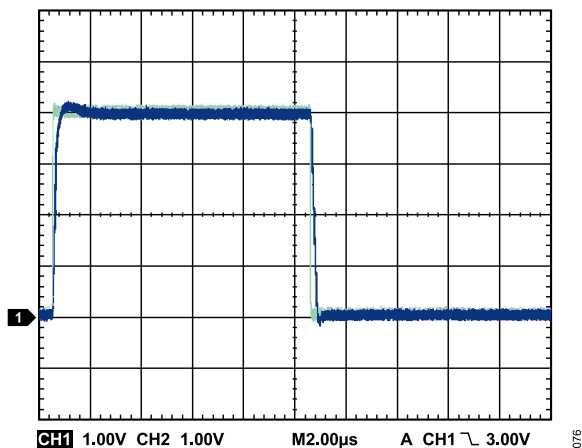


Figure 81. Bandwidth Limiting due to Headroom Requirements

The ADA4622-1/ADA4622-2/ADA4622-4 do not exhibit phase reversal for input voltages up to  $V^+$ . For input voltages greater than  $V^+$ , a  $10\text{ k}\Omega$  resistor in series with the noninverting input prevents phase reversal at the expense of higher noise (see Figure 82).

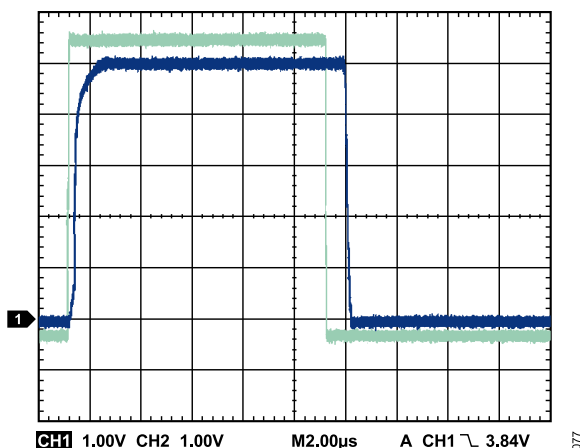


Figure 82. No Phase Reversal

Because the input stage uses N-channel JFETs, the input current during normal operation is negative. However, the input bias current changes direction as the input voltage approaches  $V^+$  due to internal junctions becoming forward-biased (see Figure 83).

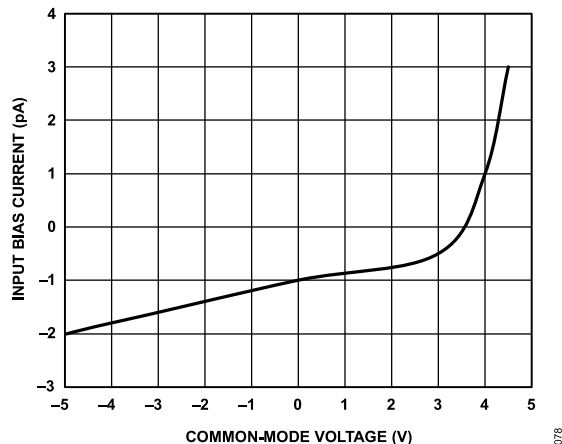


Figure 83. Input Bias Current vs. Common-Mode Voltage with  $\pm 5\text{ V}$  Supply

## THEORY OF OPERATION

The ADA4622-1/ADA4622-2/ADA4622-4 are designed for 12 nV/ $\sqrt{\text{Hz}}$  wideband input voltage noise density and maintain low noise performance at low frequencies (see Figure 84). This noise performance, along with the low input current as well as low current noise, means that the ADA4622-1/ADA4622-2/ADA4622-4 contribute negligible noise for applications with a source resistance greater than 10 k $\Omega$  and at signal bandwidths greater than 1 kHz.

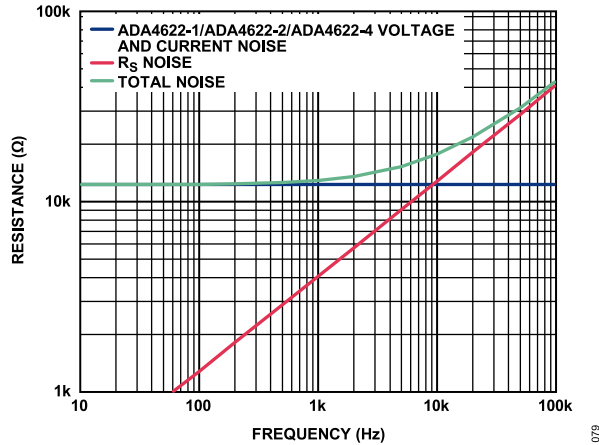


Figure 84. Total Noise vs. Source Resistance and Frequency

### Input Overvoltage Protection

The ADA4622-1/ADA4622-2/ADA4622-4 have internal protective circuitry that allows voltages as high as 0.3 V beyond the supplies applied at the input of either terminal without causing damage. Use a current-limiting resistor in series with the input of the ADA4622-1/ADA4622-2/ADA4622-4 if the input voltage exceeds 0.3 V beyond the supply rails of the amplifiers. If the overvoltage condition persists for more than a few seconds, damage to the amplifiers can result.

For higher input voltages, determine the resistor value by

$$\frac{V_{IN} - V_{SY}}{R_S} \leq 10 \text{ mA} \quad (1)$$

where:

$V_{IN}$  is the input voltage.

$V_{SY}$  is the voltage of either the V+ pin or the V- pin.

$R_S$  is the series resistor.

With a very low input bias current of  $\pm 1.5$  nA maximum up to 125°C, higher resistor values can be used in series with the inputs without introducing large offset errors. A 1 k $\Omega$  series resistor allows the ADA4622-1/ADA4622-2/ADA4622-4 to withstand 10 V of continuous overvoltage and increases the noise by a negligible amount. A 5 k $\Omega$  resistor protects the inputs from voltages as high as 25 V beyond the supplies and adds less than 10  $\mu\text{V}$  to the offset voltage of the amplifiers.

### EMI Rejection Ratio

Figure 85 shows the EMI rejection ratio (EMIRR) vs. the frequency for the ADA4622-1/ADA4622-2/ADA4622-4.

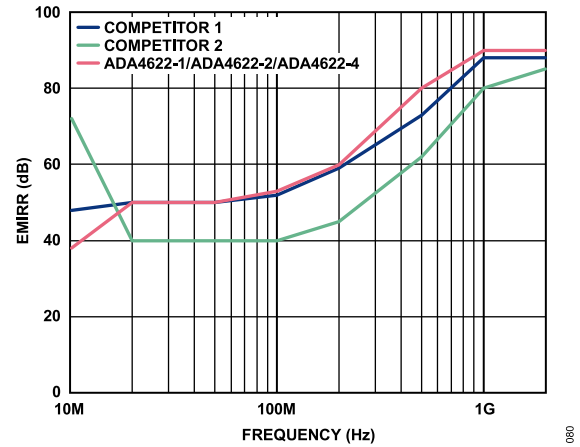


Figure 85. EMIRR vs. Frequency

### OUTPUT CHARACTERISTICS

The ADA4622-1/ADA4622-2/ADA4622-4 unique bipolar rail-to-rail output stage swings within 10 mV of the supplies with no external resistive load.

The approximate output saturation resistance of the ADA4622-1/ADA4622-2/ADA4622-4 is 24  $\Omega$ , sourcing or sinking. Use the output impedance to estimate the output saturation voltage when driving heavier loads. As an example, when driving 5 mA, the saturation voltage from either rail is approximately 120 mV.

If the ADA4622-1/ADA4622-2/ADA4622-4 output drives hard against the output saturation voltage, it recovers within 1.2  $\mu\text{s}$  of the input, returning to the linear operating region of the amplifier (see Figure 56 and Figure 59).

### Capacitive Load Drive Capability

Direct capacitive loads interact with the effective output impedance of the ADA4622-1/ADA4622-2/ADA4622-4 to form an additional pole in the feedback loop of the amplifiers, which causes excessive peaking on the pulse response or loss of stability. The worst case condition is when the devices use a single 5 V supply in a unity-gain configuration. Figure 86 shows the pulse response of the ADA4622-1/ADA4622-2/ADA4622-4 when driving 500 pF directly.

THEORY OF OPERATION

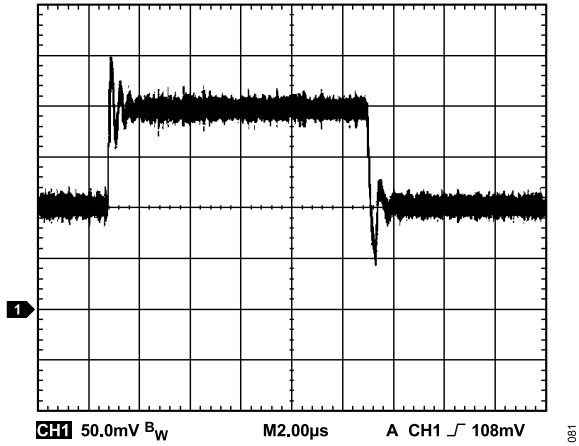


Figure 86. Pulse Response with 500 pF Load Capacitance

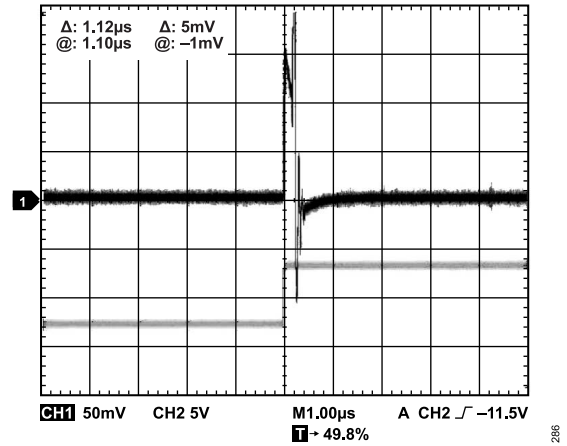


Figure 88. Start-Up Response when Toggling the  $\overline{\text{DISABLE}}$  Input

SHUTDOWN OPERATION

Use the active low  $\overline{\text{DISABLE}}$  input to put the ADA4622-1 into shutdown mode. When the voltage on the  $\overline{\text{DISABLE}}$  input is less than 1.4 V above the negative supply voltage ( $V^-$ ), the ADA4622-1 shuts down and consumes only 50  $\mu\text{A}$  to 60  $\mu\text{A}$  (typical). When the voltage on the  $\overline{\text{DISABLE}}$  input is more than 1.4 V above the negative supply voltage ( $V^-$ ), or if the  $\overline{\text{DISABLE}}$  input is left floating, the ADA4622-1 powers up. For best performance, it is recommended that the input voltage level on the  $\overline{\text{DISABLE}}$  input be  $V^-$  or that the input be left floating. The ADA4622-1 is still a drop-in replacement for devices with standard single channel op amp pinouts because the ADA4622-1 enables when the  $\overline{\text{DISABLE}}$  input is left floating. Figure 87 shows a simplified circuit for the  $\overline{\text{DISABLE}}$  input.

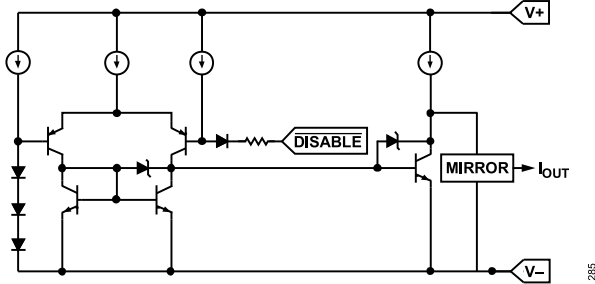


Figure 87. Simplified Circuit for the  $\overline{\text{DISABLE}}$  Input

Figure 88 and Figure 89 show the start-up and shutdown response when toggling the  $\overline{\text{DISABLE}}$  input.

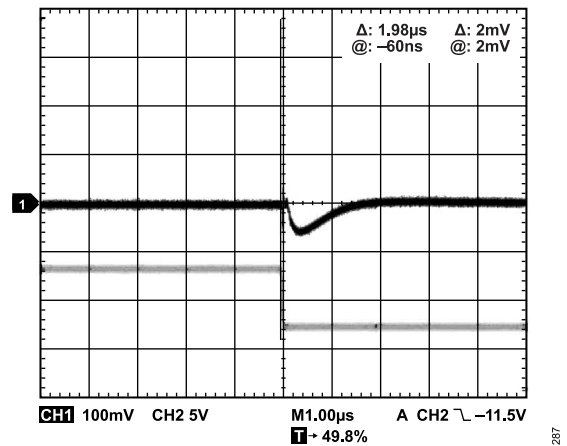


Figure 89. Shutdown Response when Toggling the  $\overline{\text{DISABLE}}$  Input

Figure 90 shows the  $\overline{\text{DISABLE}}$  input current vs. the  $\overline{\text{DISABLE}}$  input voltage relative to the negative supply voltage ( $V^-$ ).

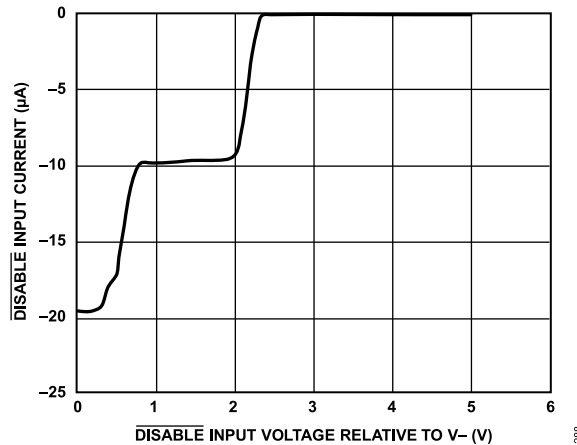


Figure 90.  $\overline{\text{DISABLE}}$  Input Current vs.  $\overline{\text{DISABLE}}$  Input Voltage Relative to  $V^-$

APPLICATIONS INFORMATION

RECOMMENDED POWER SOLUTION

The ADA4622-1/ADA4622-2/ADA4622-4 can operate from a ±2.5 V to ±15 V dual supply or a 5 V to 30 V single supply. The ADP7118 and the ADP7182 are recommended to generate the clean positive and negative rails for the ADA4622-1/ADA4622-2/ADA4622-4. Both low dropout (LDO) regulators are available in fixed output voltage or adjustable output voltage versions. To generate the input voltages for the LDOs, the ADP5070 dc-to-dc switching regulator is recommended. Figure 91 shows the recommended power solution configuration for the ADA4622-1/ADA4622-2/ADA4622-4.

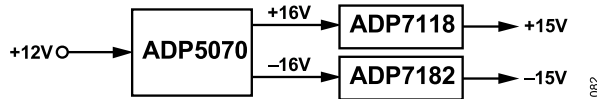


Figure 91. Power Solution Configuration for the ADA4622-1/ADA4622-2/ADA4622-4

Table 12. Recommended Power Management Devices

Product	Description
ADP5070	DC-to-DC switching regulator with independent positive and negative outputs
ADP7118	20 V, 200 mA, low noise, CMOS LDO regulator
ADP7182	-28 V, -200 mA, low noise, linear regulator

MAXIMUM POWER DISSIPATION

The maximum power the ADA4622-1/ADA4622-2/ADA4622-4 can safely dissipate is limited by the associated rise in junction temperature. For plastic packages, the maximum safe junction temperature is 150°C. If this maximum temperature is exceeded, reduce the die temperature to restore proper circuit operation. Leaving the device in the overheated condition for an extended period of time can result in device burnout. To ensure proper operation, it is important to observe the specifications shown in the Absolute Maximum Ratings and Thermal Resistance sections.

SECOND-ORDER LOW-PASS FILTER

Figure 92 shows the ADA4622-1/ADA4622-2/ADA4622-4 configured as a second-order, Butterworth, low-pass filter. With the values as shown, the corner frequency equals 200 kHz. The following equations show the component selection:

$R1 = R2 = \text{User Selected}$  (Typical Values: 10 kΩ to 100 kΩ)

$$C1 = \frac{1.414}{2\pi f_{CUTOFF} \times R1} \tag{2}$$

$$C2 = \frac{0.707}{2\pi f_{CUTOFF} \times R1} \tag{3}$$

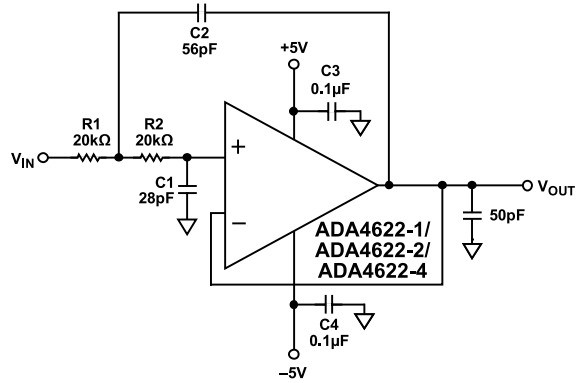


Figure 92. Second-Order, Butterworth, Low-Pass Filter

Figure 93 shows a plot of the filter; greater than 35 dB of high frequency rejection is achieved.

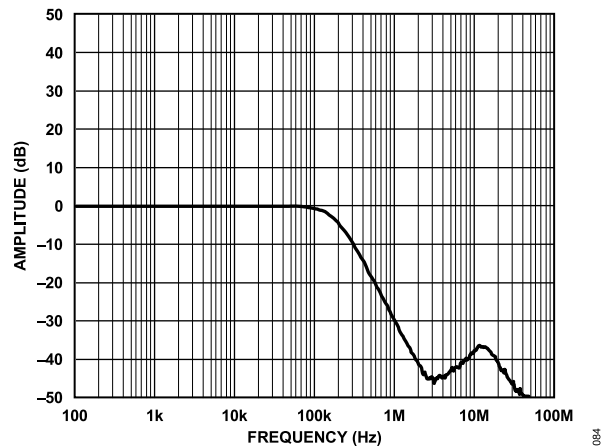


Figure 93. Frequency Response of the Filter

WIDEBAND PHOTODIODE PREAMPLIFIER

The ADA4622-1/ADA4622-2/ADA4622-4 are an excellent choice for photodiode preamplifier applications. The low input bias current minimizes the dc error at the output of the preamplifier. In addition, the high gain bandwidth product and low input capacitance maximizes the signal bandwidth of the photodiode preamplifier. Figure 94 shows the ADA4622-1/ADA4622-2/ADA4622-4 as a current to voltage (I to V) converter with an electrical model of a photodiode.

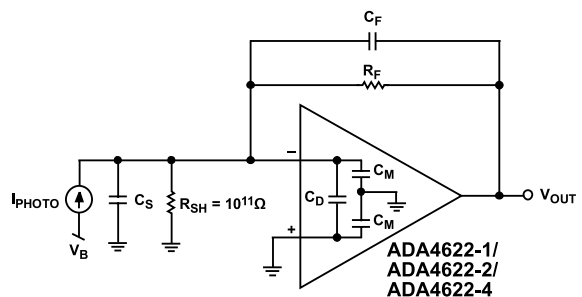


Figure 94. Wideband Photodiode Preamplifier

APPLICATIONS INFORMATION

The following basic transfer function describes the transimpedance gain of the photodiode preamplifier:

$$V_{OUT} = \frac{I_{PHOTO} \times R_F}{1 + sC_F R_F} \tag{4}$$

where:

$I_{PHOTO}$  is the output current of the photodiode.

The parallel combination of  $R_F$  and  $C_F$  sets the signal bandwidth (see the I to V gain trace in Figure 96).

s refers to the s-plane.

Note that  $R_F$  must be set so the maximum attainable output voltage corresponds to the maximum diode output current,  $I_{PHOTO}$ , which allows use of the full output swing. The attainable signal bandwidth with this photodiode preamplifier is a function of  $R_F$ , the gain bandwidth product ( $f_{GBP}$ ) of the amplifier, and the total capacitance at the amplifier summing junction, including  $C_S$  and the amplifier input capacitance,  $C_D$  and  $C_M$ .  $R_F$  and the total capacitance produce a pole with loop frequency ( $f_P$ ).

$$f_P = \frac{1}{2\pi R_F C_S} \tag{5}$$

With the additional pole from the amplifier open-loop response, the two-pole system results in peaking and instability due to an insufficient phase margin (see Figure 95).

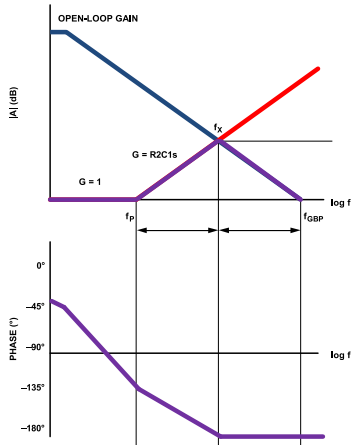


Figure 95. Gain and Phase Plot of the Transimpedance Amplifier Design, Without Compensation

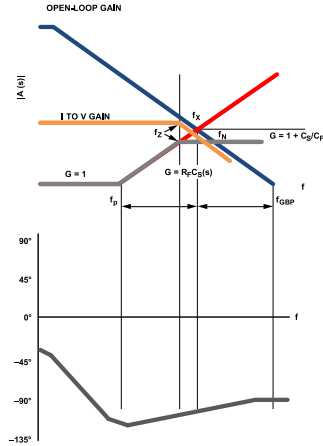


Figure 96. Gain and Phase Plot of the Transimpedance Amplifier Design with Compensation

Adding  $C_F$  creates a zero in the loop transmission that compensates for the effect of the input pole, which stabilizes the photodiode preamplifier design because of the increased phase margin. Adding  $C_F$  also sets the signal bandwidth (see Figure 96). The signal bandwidth and the zero frequency are determined by

$$f_Z = \frac{1}{2\pi R_F C_F} \tag{6}$$

where  $f_Z$  is the zero frequency.

Setting the zero at the  $f_X$  frequency maximizes the signal bandwidth with a 45° phase margin. Because  $f_X$  is the geometric mean of  $f_P$  and  $f_{GBP}$ , it can be calculated by

$$f_X = \sqrt{f_P \times f_{GBP}} \tag{7}$$

Combining these equations, the  $C_F$  value that produces  $f_X$  is

$$C_F = \sqrt{\frac{C_S}{2\pi \times R_F \times f_{GBP}}} \tag{8}$$

The frequency response in this case shows approximately 2 dB of peaking and 15% overshoot. Doubling  $C_F$  and halving the bandwidth results in a flat frequency response with approximately 5% transient overshoot.

The dominant sources of output noise in the wideband photodiode preamp design are the input voltage noise of the amplifier,  $V_{NOISE}$ , and the resistor noise due to  $R_F$ . The gray trace in Figure 96 shows the noise gain over frequencies for the photodiode preamp.

Calculate the noise bandwidth at the  $f_N$  frequency by

$$f_N = \frac{f_{GBP}}{(C_S + C_F)/C_F} \tag{9}$$

Figure 97 shows the ADA4622-1/ADA4622-2/ADA4622-4 configured as a transimpedance photodiode amplifier. The amplifiers are used in conjunction with a photodiode detector with an input capacitance of 5 pF. Figure 98 shows the transimpedance response of the ADA4622-1/ADA4622-2/ADA4622-4 when  $I_{PHOTO}$  is 1  $\mu A$

**APPLICATIONS INFORMATION**

p-p. The amplifiers have a bandwidth of 2 MHz when they are maximized for a 45° phase margin with  $C_F = 2$  pF. Note that with the PCB parasitics added to  $C_F$ , the peaking is only 0.5 dB, and the bandwidth is reduced slightly.

Increasing  $C_F$  to 3 pF completely eliminates the peaking; however, increasing  $C_F$  to 3 pF reduces the bandwidth to 1 MHz.

Table 13 shows the noise sources and total output noise for the photodiode preamp, where the preamp is configured to have a 45° phase margin for maximum bandwidth and  $f_Z = f_X = f_N$  in this case.

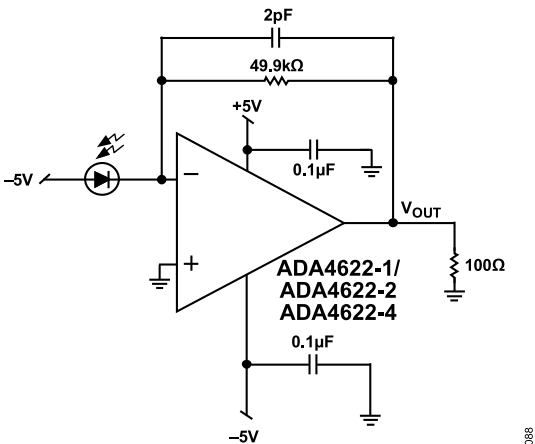


Figure 97. Transimpedance Photodiode Preamplifier

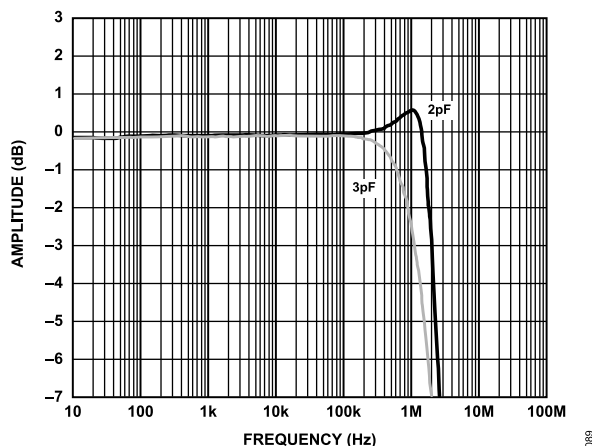


Figure 98. Transimpedance Photodiode Preamplifier Frequency Response

Table 13. RMS Noise Contributions of the Photodiode Preamplifier

Contributor	Expression	RMS Noise ( $\mu\text{V}$ ) <sup>1</sup>
$R_F$	$\sqrt{4kT \times R_F \times f_N \times \frac{\pi}{2}}$	50.8
$V_{NOISE}$	$V_{NOISE} \times \sqrt{\frac{(C_S + C_M + C_F + C_D)}{C_F}} \times \sqrt{\frac{\pi}{2} \times f_N}$	131.6
Root Sum Square (RSS) Total	$\sqrt{R_F^2 \times V_{NOISE}^2}$	141

<sup>1</sup> RMS noise with  $R_F = 50$  k $\Omega$ ,  $C_S = 5$  pF,  $C_F = 2$  pF,  $C_M = 3.7$  pF, and  $C_D = 0.4$  pF.

## APPLICATIONS INFORMATION

## PEAK DETECTOR

A peak detector captures the peak value of a signal and produces an output equal to it. By taking advantage of the dc precision and super low input bias current of the JFET input amplifiers, such as the ADA4622-1/ADA4622-2/ADA4622-4, a highly accurate peak detector can be built, as shown in Figure 99.

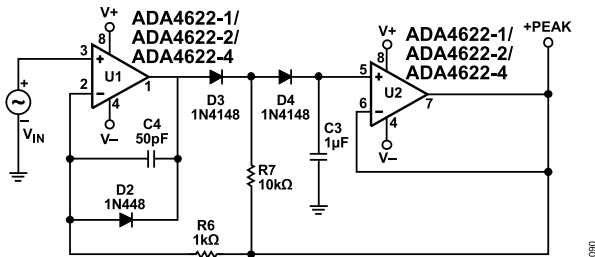


Figure 99. Positive Peak Detector

In this application, D3 and D4 act as unidirectional current switches that open when the output is kept constant in hold mode.

To detect a positive peak, U1 drives C3 through D3 and drives D4 until C3 is charged to a voltage equal to the input peak value.

Feedback from the output of the U2 (positive peak) through R6 limits the output voltage of U1. After detecting the peak, the output of U1 swings low but is clamped by D2. D3 reverses bias and the common node of D3, D4, and R7 is held to a voltage equal to positive peak by R7. The voltage across D4 is 0 V; therefore, the leakage is small. The bias current of U2 is also small. With almost no leakage, C3 has a long hold time.

The ADA4622-1/ADA4622-2/ADA4622-4, shown in Figure 99, are a perfect fit for building a peak detector because U1 requires dc precision and high output current during fast peaks, and U2 requires low input bias current ( $I_B$ ) to minimize capacitance discharge between peaks. A low leakage and low dielectric absorption capacitor, such as polystyrene or polypropylene, is required for C3. Reversing the diode directions causes the circuit to detect negative peaks.

## MULTIPLEXING INPUTS

By using the ADA4622-1  $\overline{\text{DISABLE}}$  input, it is possible to multiplex two inputs to a single output by using the circuit shown in Figure 100. If the gain configuration or filter configuration of the two amplifiers is different, and a common single input to both amplifiers is used, this configuration can control selectable gain or selectable frequency response at the output.

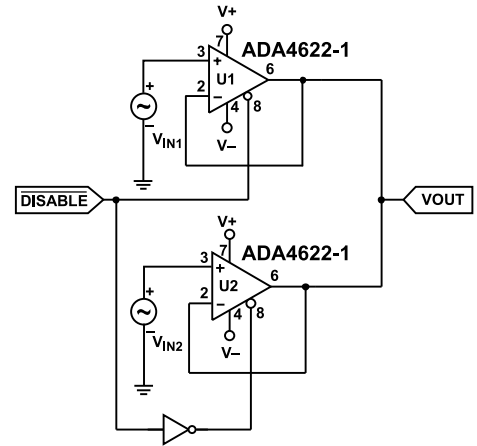


Figure 100. Multiplexed Input Circuit

Figure 101 shows the output response when multiplexing two input signals. The input to the first amplifier is a 4 V p-p, 200 kHz sine wave; the input to the second amplifier is an 8 V p-p, 100 kHz sine wave.

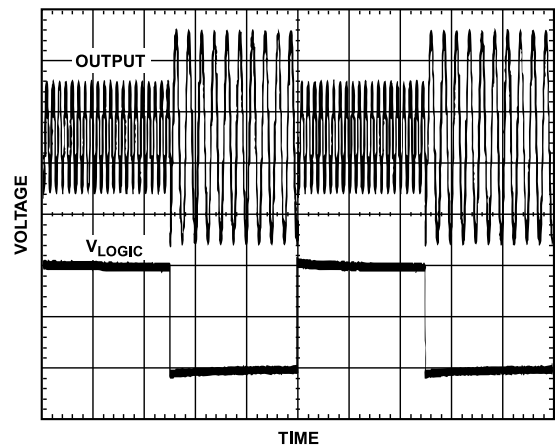


Figure 101. Multiplexed Output

## FULL WAVE RECTIFIER

Figure 102 shows the circuit of a full wave rectifier using two ADA4622-1 op amps in single-supply operation. The circuit is composed of a voltage follower (U1) and a second stage amplifier (U2) that combine the output of the first stage amplifier and the inverted version of the input signal. U1 follows the input during the positive half cycle and clamps the negative going input signal to ground, producing a half wave signal at  $V_{HW}$ . The following equation defines the circuit transfer function:

$$V_{FW} = (1 + R3/R2)V_{HW} - (R3/R2) \times V_{IN}$$

where:

$V_{FW}$  is the full wave output from U1.

$R3$  and  $R2$  are the feedback resistors shown in Figure 102.

$V_{HW}$  is the half wave output from U1.

$V_{IN}$  is the input voltage.



## APPLICATIONS INFORMATION

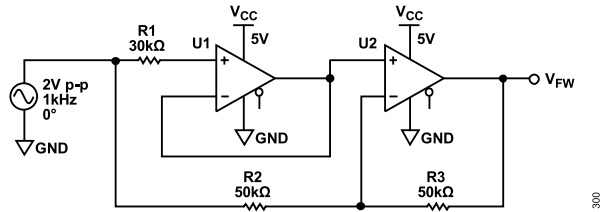


Figure 102. Full Wave Rectifier Circuit

During the input positive half cycle, U1 follows the input so that  $V_{HW} = V_{IN}$ ; therefore,  $V_{FW} = V_{IN}$ . During the negative half cycle, U1 clamps the signal to ground so that  $V_{HW} = 0$  V; therefore,  $V_{FW} = -(R3/R2) \times V_{IN} = -V_{IN}$  because  $R3/R2 = 1$ . Figure 103 shows the input and outputs waveforms from the circuit. The input is a 2 V p-p, 1 kHz sine wave while the circuit is running on a 5 V single supply.

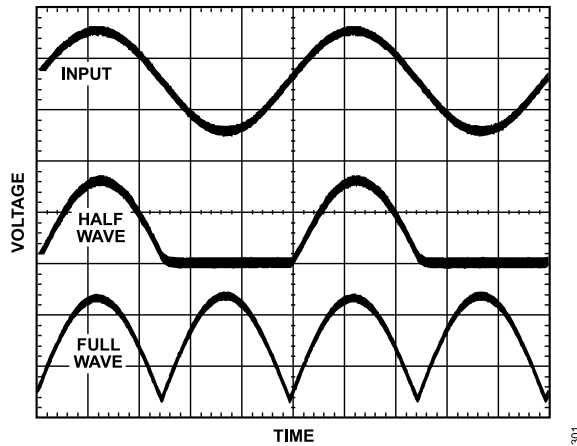
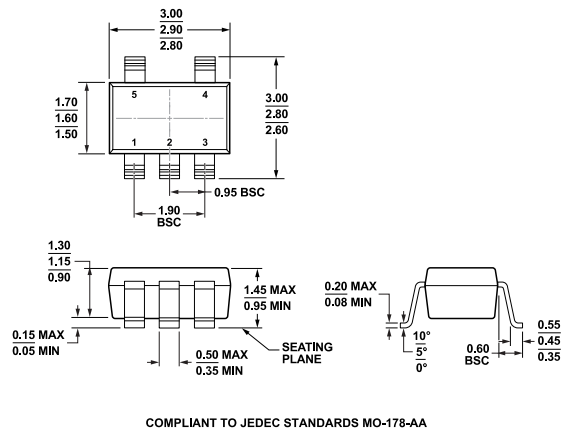
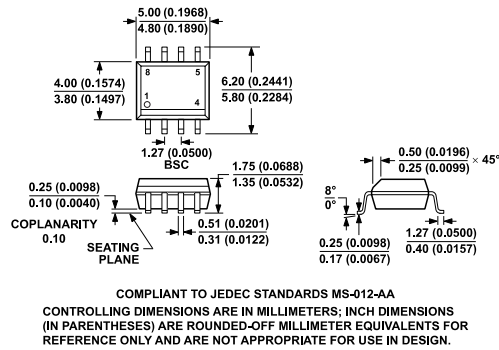


Figure 103. Full Wave and Half Wave Rectifier Input and Output Waveforms

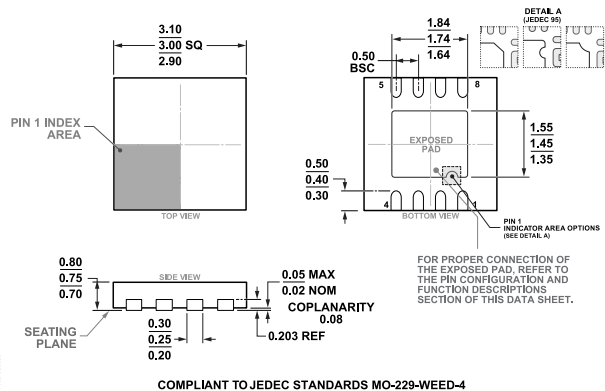
OUTLINE DIMENSIONS



**Figure 104. 5-Lead Small Outline Transistor Package [SOT-23] (RJ-5)**  
Dimensions shown in millimeters

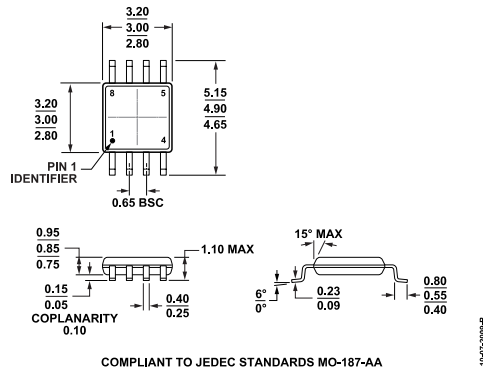


**Figure 105. 8-Lead Standard Small Outline Package [SOIC\_N] Narrow Body (R-8)**  
Dimensions shown in millimeters and (inches)

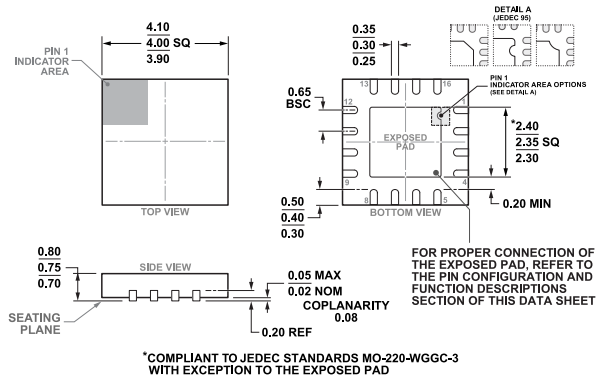


**Figure 106. 8-Lead Lead Frame Chip Scale Package [LFCSP] 3 mm x 3 mm Body and 0.75 mm Package Height (CP-8-13)**  
Dimensions shown in millimeters

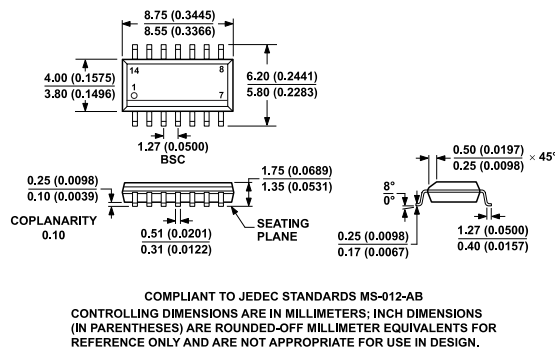
OUTLINE DIMENSIONS



**Figure 107. 8-Lead Mini Small Outline Package [MSOP] (RM-8)**  
 Dimensions shown in millimeters



**Figure 108. 16-Lead Lead Frame Chip Scale Package [LFCSP] 4 mm × 4 mm Body and 0.75 mm Package Height (CP-16-20)**  
 Dimensions shown in millimeters



**Figure 109. 14-Lead Standard Small Outline Package [SOIC\_N] (R-14)**  
 Dimensions shown in millimeters and (inches)