

FEATURES

Triaxial, digital gyroscope

- ±125°/sec, ±450°/sec, ±2000°/sec range options
- ±0.05° axis to axis misalignment error
- ±0.25° (maximum) axis to package misalignment error
- 0.8°/hr in-run bias stability (ADIS16495-1)
- 0.09°/√hr angular random walk (ADIS16495-1)

Triaxial, digital accelerometer, ±8 g

- 3.2 μg in run bias stability

Triaxial, delta angle and delta velocity outputs

Factory calibrated sensitivity, bias, and axial alignment

- Calibration temperature range: -40°C to +85°C

SPI compatible

Programmable operation and control

- Automatic and manual bias correction controls
- Configurable FIR filters
- Digital I/O: data ready, external clock
- Sample clock options: internal, external, or scaled
- On demand self test of inertial sensors

Single-supply operation: 3.0 V to 3.6 V

1500 g mechanical shock survivability

Operating temperature range: -40°C to +105°C

APPLICATIONS

Precision instrumentation, stabilization

Guidance, navigation, control

Avionics, unmanned vehicles

Precision autonomous machines, robotics

GENERAL DESCRIPTION

The ADIS16495 is a complete inertial system that includes a triaxis gyroscope and a triaxis accelerometer. Each inertial sensor in the ADIS16495 combines industry leading iMEMS® technology with signal conditioning that optimizes dynamic performance. The factory calibration characterizes each sensor for sensitivity, bias, alignment, and linear acceleration (gyroscope bias). As a result, each sensor has its own dynamic compensation formulas that provide accurate sensor measurements.

The ADIS16495 provides a simple, cost effective method for integrating accurate, multi-axis inertial sensing into industrial systems, especially when compared with the complexity and investment associated with discrete designs. All necessary motion testing and calibration are part of the production process at the factory, greatly reducing system integration time. Tight orthogonal alignment simplifies inertial frame alignment in navigation systems. The serial peripheral interface (SPI) and register structure provide a simple interface for data collection and configuration control.

The footprint and connector system of the ADIS16495 enable a simple upgrade from the [ADIS16375](#), [ADIS16480](#), [ADIS16485](#), [ADIS16488A](#), and [ADIS16490](#). The ADIS16495 is available in an aluminum package that is approximately 47 mm × 44 mm × 14 mm and includes a standard connector interface.

FUNCTIONAL BLOCK DIAGRAM

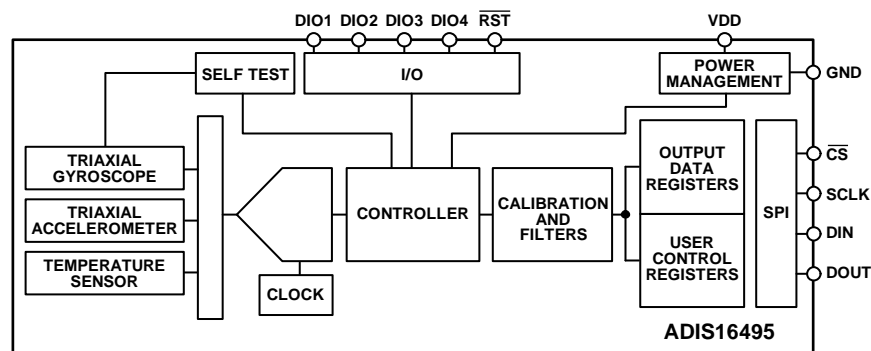

Figure 1.

TABLE OF CONTENTS

| | | | |
|--|----|---|----|
| Features..... | 1 | Time Stamp..... | 24 |
| Applications | 1 | Cyclical Redundancy Check (CRC-32)..... | 24 |
| General Description..... | 1 | Delta Angles..... | 25 |
| Functional Block Diagram..... | 1 | Delta Velocity..... | 26 |
| Revision History..... | 2 | User Bias/Scale Adjustment..... | 29 |
| Specifications | 4 | Scratch Registers, USER_SCR_x..... | 31 |
| Timing Specifications..... | 6 | Flash Memory Endurance Counter, FLSHCNT_LOW, FLSHCNT_HIGH..... | 32 |
| Absolute Maximum Ratings..... | 8 | Global Commands, GLOB_CMD | 32 |
| Thermal Resistance..... | 8 | Auxiliary I/O Line Configuration, FNCTIO_CTRL..... | 33 |
| ESD Caution..... | 8 | General-Purpose I/O Control, GPIO_CTRL..... | 34 |
| Pin Configuration and Function Descriptions..... | 9 | Miscellaneous Configuration, CONFIG..... | 34 |
| Typical Performance Characteristics..... | 10 | Linear Acceleration on Effect on Gyroscope Bias..... | 35 |
| Theory of Operation | 12 | Decimation Filter, DEC_RATE | 35 |
| Binertial Sensor Signal Chain..... | 12 | Continuous Bias Estimation (CBE), NULL_CNFG..... | 35 |
| Register Structure..... | 13 | Scaling the Input Clock (PPS Mode), SYNC_SCALE..... | 36 |
| Serial Peripheral Interface..... | 14 | FIR Filters..... | 36 |
| Data Ready..... | 14 | Firmware Revision, FIRM_REV | 38 |
| Reading Sensor Data..... | 15 | Applications Information | 40 |
| Device Configuration | 16 | Mounting Best Practices | 40 |
| User Register Memory Map..... | 17 | Preventing Misinsertion..... | 40 |
| User Register Definitions | 20 | Evaluation Tools..... | 40 |
| Page Number (PAGE_ID) | 20 | Power Supply Considerations | 40 |
| Data/Sample Counter (DATA_CNT)..... | 20 | CRC32 Coding Example | 41 |
| Status/Error Flag Indicators (SYS_E_FLAG)..... | 20 | Outline Dimensions..... | 42 |
| Self Test Error Flags (DIAG_STS)..... | 21 | Ordering Guide | 42 |
| Internal Temperature (TEMP_OUT)..... | 21 | | |
| Gyroscope Data | 21 | | |
| Acceleration Data..... | 23 | | |

REVISION HISTORY

| | |
|---|----|
| 7/2019—Rev. B to Rev. C | |
| Changes to Table 1 | 5 |
| Changes to tSTALL Parameter and Endnote 2, Table 2 | 6 |
| Changes to Flash Memory Update Section and On Demand Self Test (ODST) Section..... | 33 |
| Changes to Data Ready Indicator Section | 34 |
| Changes to Scaling the Input Clock (PPS Mode), SYNC_SCALE Section..... | 36 |
| 5/2019—Rev. A to Rev. B | |
| Changes to Features Section | 1 |
| Changes to Specifications Section and Table 1 | 4 |
| Changes to Figure 5 and Figure 6 | 7 |
| Changes to Table 6..... | 9 |
| Changes to Figure 12 | 10 |
| Added Figure 13 and Figure 14; Renumbered Sequentially..... | 10 |
| Added Figure 15 and Figure 16..... | 11 |
| Changes to Burst Read Function Section, Table 10, and Table 11..... | 15 |
| Changes to Table 12..... | 17 |
| Changes to Model Column, Table 24..... | 21 |
| Changes to Cyclical Redundancy Check (CRC-32) Section | 24 |
| Changes to Delta Angle Measurement Range and Model Column, Table 60..... | 25 |

Changes to Delta Velocity Section.....26
Changes to Accelerometer Scale Adjustment, X_ACCL_SCALE
Section.....29
Changes to Table 150 and Continuous Bias Estimation (CBE),
NULL_CNFG Section35
Changes to Description Column, Table 156.....36
Added CRC32 Coding Example Section41
Updated Outline Dimensions42

11/2017—Rev. 0 to Rev. A

Changes to Table 1..... 3
Added Endnote 2, Table 1; Renumbered Sequentially..... 4
Changes to t_2 Parameter, Table 2 5
Changes to Table 3..... 5

10/2017—Revision 0: Initial Version

SPECIFICATIONS

T_C = 25°C, VDD = 3.3 V, angular rate = 0°/sec, ADIS16495-1 model, ±1 g, unless otherwise noted.

Table 1.

| Parameter | Test Conditions/Comments | Min | Typ | Max | Unit |
|-----------------------------------|---|-------------------------------------|-----------|-------|----------------------|
| GYROSCOPES | | | | | |
| Dynamic Range | ADIS16495-1 | ±125 | | | °/sec |
| | ADIS16495-2 | ±450 | | ±480 | °/sec |
| | ADIS16495-3 | ±2000 | | | °/sec |
| Sensitivity | ADIS16495-1, 32-bit | | 10485760 | | LSB/°/sec |
| | ADIS16495-2, 32-bit | | 2621440 | | LSB/°/sec |
| | ADIS16495-3, 32-bit | | 655360 | | LSB/°/sec |
| Error Over Temperature | −40°C ≤ T _C ≤ +85°C, 1 σ | | ±0.2 | | % |
| Repeatability ¹ | −40°C ≤ T _C ≤ +85°C, 1 σ | | ±0.2 | | % |
| Misalignment | Axis to axis, −40°C ≤ T _C ≤ +85°C, 1 σ | | ±0.05 | | Degrees |
| | Axis to package, −40°C ≤ T _C ≤ +85°C | | | ±0.25 | Degrees |
| Nonlinearity ² | 1 σ, ADIS16495-1, FS = 125°/sec | | 0.2 | | % FS |
| | 1 σ, ADIS16495-2, FS = 450°/sec | | 0.2 | | % FS |
| | 1 σ, ADIS16495-3, FS = 2000°/sec | | 0.25 | | % FS |
| Bias | | | | | |
| Repeatability ³ | −40°C ≤ T _C ≤ +85°C, 1 σ | | 0.07 | | °/sec |
| In Run Bas Stability | 1 σ, ADIS16495-1 | | 0.8 | | °/hr |
| | 1 σ, ADIS16495-2 | | 1.6 | | °/hr |
| | 1 σ, ADIS16495-3 | | 3.3 | | °/hr |
| Angular Random Walk | 1 σ, ADIS16495-1 | | 0.09 | | °/√hr |
| | 1 σ, ADIS16495-2 | | 0.1 | | °/√hr |
| | 1 σ, ADIS16495-3 | | 0.18 | | °/√hr |
| Error over Temperature | −40°C ≤ T _C ≤ +85°C, 1 σ | | ±0.1 | | °/sec |
| Linear Acceleration Effect | Any axis, 1 σ (CONFIG register, Bit 7 = 1) | | 0.006 | | °/sec/g |
| | Any axis, 1 σ (CONFIG register, Bit 7 = 0) | | 0.015 | | °/sec/g |
| Vibration Rectification Error | 1 σ, ADIS16495-1 | | 0.0003 | | °/sec/g ² |
| Noise | | | | | |
| Output Noise | No filtering, ADIS16495-1 | | 0.051 | | °/sec rms |
| | No filtering, ADIS16495-2 | | 0.058 | | °/sec rms |
| | No filtering, ADIS16495-3 | | 0.112 | | °/sec rms |
| Rate Noise Density ⁴ | 1 σ, ADIS16495-1 | | 0.002 | | °/sec/√Hz rms |
| | 1 σ, ADIS16495-2 | | 0.0022 | | °/sec/√Hz rms |
| | 1 σ, ADIS16495-3 | | 0.0042 | | °/sec/√Hz rms |
| −3 dB Bandwidth | ADIS16495-1 | | 480 | | Hz |
| | ADIS16495-2, ADIS16495-3 | | 550 | | Hz |
| Sensor Resonant Frequency | | | 65 | | kHz |
| ACCELEROMETERS⁵ | | | | | |
| Dynamic Range | Each axis | ±8 | | | g |
| Sensitivity | x_ACCL_OUT and x_ACCL_LOW (32-bit) | | 262144000 | | LSB/g |
| | Error Over Temperature | −40°C ≤ T _C ≤ +85°C, 1 σ | ±0.01 | | % |
| Repeatability | −40°C ≤ T _C ≤ +85°C, 1 σ | | 0.05 | | % |
| Misalignment | Axis to axis, −40°C ≤ T _C ≤ +85°C, 1 σ | | ±0.035 | | Degrees |
| | Axis to package, −40°C ≤ T _C ≤ +85°C | | | ±0.25 | Degrees |
| Nonlinearity | Best fit straight line, ±2 g, FS = 8 g | | 0.25 | | % FS |
| | Best fit straight line, ±4 g, FS = 8 g | | 0.5 | | % FS |
| | Best fit straight line, ±8 g, FS = 8 g | | 1.5 | | % FS |
| Bias | | | | | |
| In Run Stability | 1 σ | | 3.2 | | μg |
| Velocity Random Walk | 1 σ | | 0.008 | | m/sec/√hr |

| Parameter | Test Conditions/Comments | Min | Typ | Max | Unit |
|--|--|---------|-----------|-----|------------------------------------|
| Error over Temperature | $-40^{\circ}\text{C} \leq T_c \leq +85^{\circ}\text{C}$, 1σ | | ± 0.5 | | mg |
| Repeatability | $-40^{\circ}\text{C} \leq T_c \leq +85^{\circ}\text{C}$, 1σ | | 1 | | mg |
| Noise | | | | | |
| Output Noise | No filtering | | 0.5 | | mg rms |
| Noise Density | 10 Hz to 40 Hz, no filtering | | 17 | | $\mu\text{g}/\sqrt{\text{Hz}}$ rms |
| -3 dB Bandwidth | | | 750 | | Hz |
| Sensor Resonant Frequency | | | 2.5 | | kHz |
| TEMPERATURE SENSOR | | | | | |
| Scale Factor | Output = 0x0000 at 25°C ($\pm 5^{\circ}\text{C}$) | | 0.0125 | | $^{\circ}\text{C}/\text{LSB}$ |
| LOGIC INPUTS ⁶ | | | | | |
| Input Voltage | | | | | |
| High, V_{IH} | | 2.0 | | | V |
| Low, V_{IL} | | | | 0.8 | V |
| $\overline{\text{RST}}$ Pulse Width | | 1 | | | μs |
| $\overline{\text{CS}}$ Wake-Up Pulse Width | | 20 | | | μs |
| Input Current | | | | | |
| Logic 1, I_{IH} | $V_{IH} = 3.3 \text{ V}$ | | | 10 | μA |
| Logic 0, I_{IL} | $V_{IL} = 0 \text{ V}$ | | | | |
| All Pins Except $\overline{\text{RST}}$, $\overline{\text{CS}}$ | | | | 10 | μA |
| $\overline{\text{RST}}$, $\overline{\text{CS}}$ Pins ⁷ | | | 0.33 | | mA |
| Input Capacitance, C_{IN} | | | 10 | | pF |
| DIGITAL OUTPUTS ⁶ | | | | | |
| Output Voltage | | | | | |
| High, V_{OH} | $I_{SOURCE} = 0.5 \text{ mA}$ | 2.4 | | | V |
| Low, V_{OL} | $I_{SINK} = 2.0 \text{ mA}$ | | | 0.4 | V |
| FLASH MEMORY | | | | | |
| Endurance ⁸ | | 100,000 | | | Cycles |
| Data Retention ⁹ | $T_J = 85^{\circ}\text{C}$ | 20 | | | Years |
| FUNCTIONAL TIMES ¹⁰ | Time until data is available, $-40^{\circ}\text{C} \leq T_c \leq +85^{\circ}\text{C}$, 1σ | | | | |
| Power-On Start-Up Time | | | 265 | | ms |
| Reset Recovery Time ¹¹ | $\overline{\text{GLOB_CMD}}$ register, Bit 7 = 1 (see Table 142) | | 225 | | ms |
| | $\overline{\text{RST}}$ pulled low, then restored to high | | 265 | | ms |
| Flash Memory | | | | | |
| Update Time | $\overline{\text{GLOB_CMD}}$ register, Bit 3 = 1 (see Table 142) | | 1300 | | ms |
| Clear User Calibration | $\overline{\text{GLOB_CMD}}$ register, Bit 6 = 1 (see Table 142) | | 350 | | μs |
| Self Test Time ¹² | $\overline{\text{GLOB_CMD}}$ register, Bit 1 = 1 (see Table 142) | | 30 | | ms |
| CONVERSION RATE | | | | | |
| Initial Clock Accuracy | | | 4.25 | | kSPS |
| Temperature Coefficient | | | 0.02 | | % |
| Sync Input Clock | | 3.0 | | 4.5 | kHz |
| Pulse Per Second (PPS) Mode | | 1 | | 128 | Hz |
| POWER SUPPLY, VDD | | | | | |
| Operating voltage range | | 3.0 | | 3.6 | V |
| Power Supply Current ¹³ | Normal mode, $V_{DD} = 3.3 \text{ V}$, $\mu + \sigma$ | | 89 | | mA |

¹ Bias repeatability provides an estimate for long-term drift in the bias, as observed during 500 hours of High-Temperature Operating Life (HTOL) at $+105^{\circ}\text{C}$.

² FS means full scale, $FS = 125^{\circ}/\text{sec}$ (ADIS16495-1), $FS = 450^{\circ}/\text{sec}$ (ADIS16495-2), $FS = 2000^{\circ}/\text{sec}$ (ADIS16495-3).

³ Bias repeatability provides an estimate for long-term drift in the bias, as observed during 500 hours of High-Temperature Operating Life (HTOL) at $+105^{\circ}\text{C}$.

⁴ Magnitude between 10 Hz and 40 Hz, sample rate is 4250 SPS (nominal), no digital filtering.

⁵ All specifications associated with the accelerometers relate to the full-scale range of $\pm 8 g$.

⁶ The digital I/O signals use a 3.3 V system.

⁷ $\overline{\text{RST}}$ and $\overline{\text{CS}}$ pins are connected to the VDD pin through 10k Ω pull-up resistors.

⁸ Endurance is qualified as per JEDEC Standard 22, Method A117, measured at -40°C , $+25^{\circ}\text{C}$, $+85^{\circ}\text{C}$, and $+125^{\circ}\text{C}$.

⁹ The data retention specification assumes a junction temperature (T_J) of 85°C per JEDEC Standard 22, Method A117. Data retention lifetime decreases with T_J .

¹⁰ These times do not include thermal settling and internal filter response times, which can affect overall accuracy.

¹¹ The $\overline{\text{RST}}$ line must be in a low state for at least 10 μs to ensure a proper reset initiation and recovery.

¹² Self test time can extend when using external clock rates that are lower than 4000 Hz.

¹³ Supply current transients can reach 250 mA during initial startup or reset recovery.

TIMING SPECIFICATIONST_C = 25°C, VDD = 3.3 V, unless otherwise noted.**Table 2.**

| Parameter | Description | Normal Mode | | | Burst Read Function | | | Unit |
|-----------------------------------|--|------------------|-----|------------------|---------------------|-----|------------------|------|
| | | Min ¹ | Typ | Max ¹ | Min | Typ | Max ¹ | |
| f _{SCLK} | SCLK frequency | 0.01 | | 15 | | | 6.5 | MHz |
| t _{STALL} ² | Stall period between data | 5 | | | | N/A | | μs |
| t _{CLS} | SCLK low period | 31 | | | 31 | | | ns |
| t _{CHS} | SCLK high period | 31 | | | 31 | | | ns |
| t _{CS} | CS to SCLK edge | 32 | | | 32 | | | ns |
| t _{DAV} | DOUT valid after SCLK edge | | | 10 | | | 10 | ns |
| t _{DSU} | DIN setup time before SCLK rising edge | 2 | | | 2 | | | ns |
| t _{DHD} | DIN hold time after SCLK rising edge | 2 | | | 2 | | | ns |
| t _{DR} , t _{DF} | DOUT rise/fall times, ≤100 pF loading | | 3 | 8 | | 3 | 8 | ns |
| t _{DSOE} | CS assertion to DOUT active | 0 | | 11 | 0 | | 11 | ns |
| t _{HD} | SCLK edge to DOUT invalid | 0 | | | 0 | | | ns |
| t _{SFS} | Last SCLK edge to CS deassertion | 32 | | | 32 | | | ns |
| t _{DSHI} | CS deassertion to DOUT high impedance | 0 | | 9 | 0 | | 9 | ns |
| t _{INV} | Data invalid time | | 20 | | | 20 | | μs |
| t ₁ | Input sync pulse width | 5 | | | 5 | | | μs |
| t ₂ | Input sync to data invalid | | 306 | | | 306 | | μs |
| t ₃ | Input sync period ³ | 222.2 | | | 222.2 | | | μs |

¹ Guaranteed by design and characterization, but not tested in production.² See Table 3 for exceptions to the stall time rating. An insufficient stall time results in reading all 0s for the register attempting to be read.³ This measurement represents the inverse of the maximum frequency for the input sample clock: 4500 Hz.**Register Specific Stall Times****Table 3.**

| Parameter | Description | Min ¹ | Typ | Max | Unit |
|-----------------|--|------------------|-----|-----|------|
| STALL TIME | | | | | |
| FNCTIO_CTRL | Configure the DIOx functions | 340 | | | μs |
| FILTR_BNK_0 | Enable/select finite impulse response (FIR) filter banks | 65 | | | μs |
| FILTR_BNK_1 | Enable/select FIR filter banks | 65 | | | μs |
| NULL_CNFG | Configure autonull bias function | 71 | | | μs |
| SYNC_SCALE | Configure input clock scale factor | 340 | | | μs |
| DEC_RATE | Configure decimation rate | 340 | | | μs |
| GPIO_CTRL | Configure general-purpose input/output (I/O) lines | 45 | | | μs |
| CONFIG | Configure miscellaneous functions | 45 | | | μs |
| GLOB_CMD, Bit 1 | On demand self test | 20 | | | ms |
| GLOB_CMD, Bit 3 | Flash memory update | 1120 | | | ms |
| GLOB_CMD, Bit 6 | Factory calibration restore | 350 | | | μs |
| GLOB_CMD, Bit 7 | Software reset | 210 | | | ms |

¹ Monitoring the data ready signal (see Table 144 for FNCTIO_CTRL configuration) for the return of regular pulsing can help minimize system wait times.

Timing Diagrams

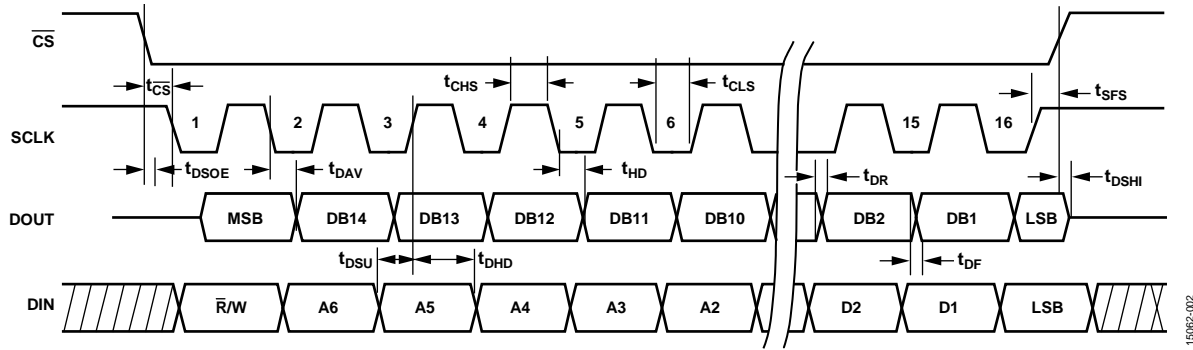

Figure 2. SPI Timing and Sequence

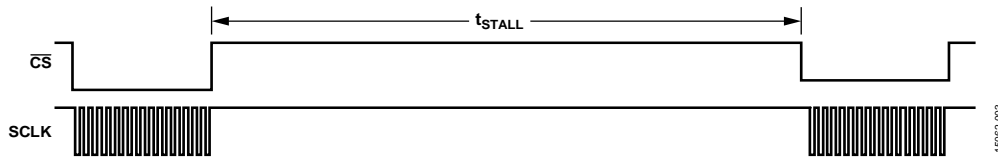

Figure 3. Stall Time and Data Rate

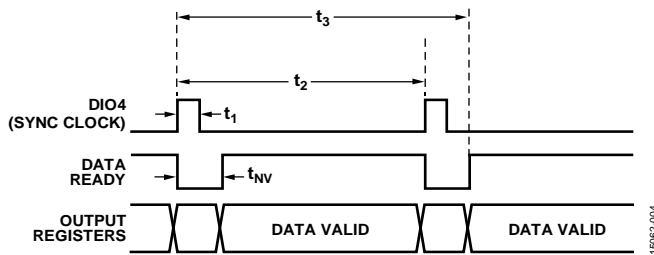

Figure 4. Input Clock Timing Diagram, FNCTIO_CTRL, Bits[7:4] = 0xFD

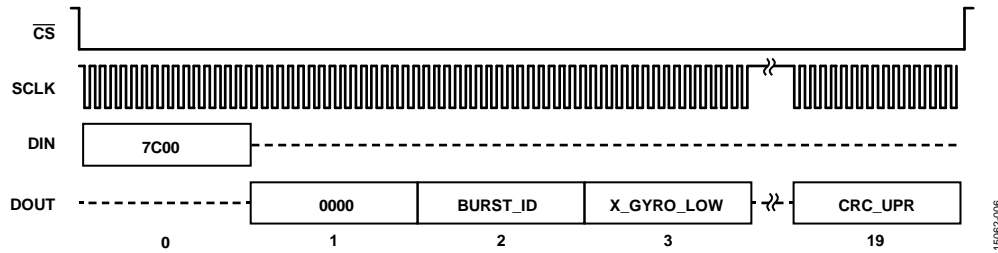

Figure 5. Burst Read Function Sequence Diagram, 19 Segments

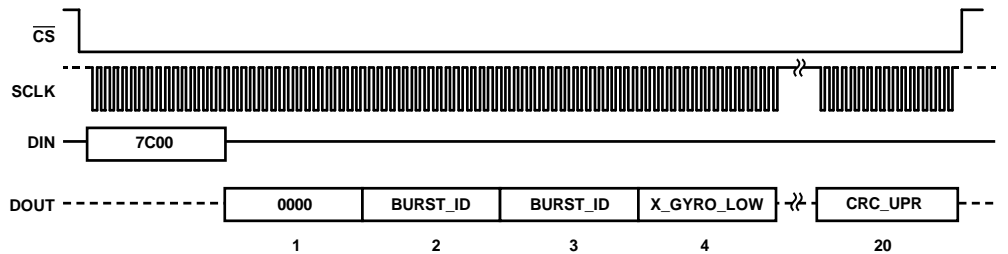

Figure 6. Burst Read Function Sequence Diagram, 20 Segments

ABSOLUTE MAXIMUM RATINGS

Table 4.

| Parameter | Rating |
|--|-----------------------|
| Mechanical Shock Survivability | |
| Any Axis, Unpowered | 1500 g |
| Any Axis, Powered | 1500 g |
| VDD to GND | −0.3 V to +3.6 V |
| Digital Input Voltage to GND | −0.3 V to VDD + 0.2 V |
| Digital Output Voltage to GND | −0.3 V to VDD + 0.2 V |
| Operating Temperature Range | −40°C to +105°C |
| Storage Temperature Range ¹ | −55°C to +150°C |
| Barometric Pressure | 2 bar |

¹ Extended exposure to temperatures that are lower than −40°C or higher than +105°C can adversely affect the accuracy of the factory calibration.

Stresses at or above those listed under Absolute Maximum Ratings may cause permanent damage to the product. This is a stress rating only; functional operation of the product at these or any other conditions above those indicated in the operational section of this specification is not implied. Operation beyond the maximum operating conditions for extended periods may affect product reliability.

THERMAL RESISTANCE

Thermal performance is directly linked to printed circuit board (PCB) design and operating environment. Pay careful attention to PCB thermal design.

θ_{JA} is the natural convection junction to ambient thermal resistance measured in a one cubic foot sealed enclosure.

θ_{JC} is the junction to case thermal resistance.

The ADIS16495 is a multichip module, which includes many active components. The values in Table 5 identify the thermal response of the hottest component inside of the ADIS16495, with respect to the overall power dissipation of the module.

This approach enables a simple method for predicting the temperature of the hottest junction, based on either ambient or case temperature.

For example, when the $T_A = 70^\circ\text{C}$, the hottest junction inside of the ADIS16495 is 76.7°C .

$$T_J = \theta_{JA} \times V_{DD} \times I_{DD} + 70^\circ\text{C}$$

$$T_J = 22.8^\circ\text{C/W} \times 3.3 \text{ V} \times 0.089 \text{ A} + 70^\circ\text{C}$$

$$T_J = 76.7^\circ\text{C}$$

Table 5. Package Characteristics

| Package Type | θ_{JA} | θ_{JC} | Device Weight |
|----------------------|---------------|---------------|---------------|
| ML-24-9 ¹ | 30.7°C/W | 20.9°C/W | 42 g |

¹ Thermal impedance simulated values come from a case when 4 M2 × 0.4 mm machine screws (torque = 20 inch ounces) secure the ADIS16495 to the PCB.

ESD CAUTION



ESD (electrostatic discharge) sensitive device.

Charged devices and circuit boards can discharge without detection. Although this product features patented or proprietary protection circuitry, damage may occur on devices subjected to high energy ESD. Therefore, proper ESD precautions should be taken to avoid performance degradation or loss of functionality.

PIN CONFIGURATION AND FUNCTION DESCRIPTIONS

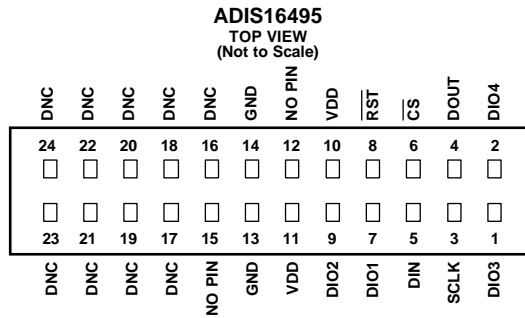

- NOTES**
1. THIS REPRESENTATION DISPLAYS THE TOP VIEW PINOUT FOR THE MATING SOCKET CONNECTOR.
 2. THE ACTUAL CONNECTOR PINS ARE NOT VISIBLE FROM THE TOP VIEW.
 3. MATING CONNECTOR: SAMTEC CLM-112-02 OR EQUIVALENT.
 4. DNC = DO NOT CONNECT.
 5. PIN 12 AND PIN 15 ARE NOT PHYSICALLY PRESENT.

Figure 7. Pin Configuration

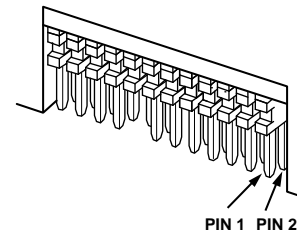
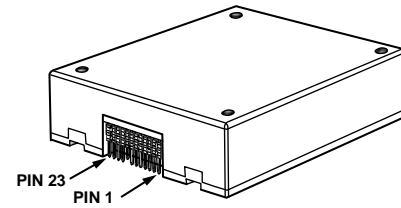

Figure 8. Axial Orientation (Top Side Facing Up)

Table 6. Pin Function Descriptions

| Pin No. | Mnemonic | Type | Description |
|--------------|----------|----------------|--|
| 1 | DIO3 | Input/output | Configurable Digital Input/Output 3. |
| 2 | DIO4 | Input/output | Configurable Digital Input/Output 4. |
| 3 | SCLK | Input | SPI Serial Clock. |
| 4 | DOUT | Output | SPI Data Output. Clocks output on the SCLK falling edge. |
| 5 | DIN | Input | SPI Data Input. Clocks input on the SCLK rising edge. |
| 6 | CS | Input | SPI Chip Select. |
| 7 | DIO1 | Input/output | Configurable Digital Input/Output 1. |
| 8 | RST | Input | Reset. |
| 9 | DIO2 | Input/output | Configurable Digital Input/Output 2. |
| 10, 11 | VDD | Supply | Power Supply. |
| 12, 15 | NO PIN | Not applicable | No Pin. These pins are not physically present. |
| 13, 14 | GND | Supply | Power Ground. |
| 16 to 22, 24 | DNC | Not applicable | Do Not Connect. Do not connect to these pins. |
| 23 | DNC | Not applicable | Do Not Connect. Do not connect to this pin. This pin can tolerate connection to 3.3 V. |

TYPICAL PERFORMANCE CHARACTERISTICS

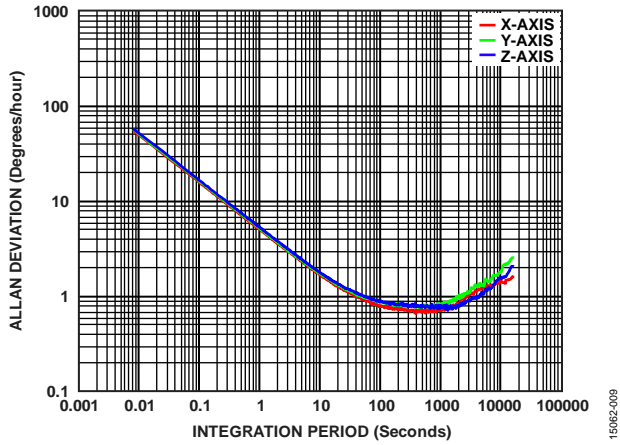

Figure 9. Gyroscope Allan Deviation, ADIS16495-1

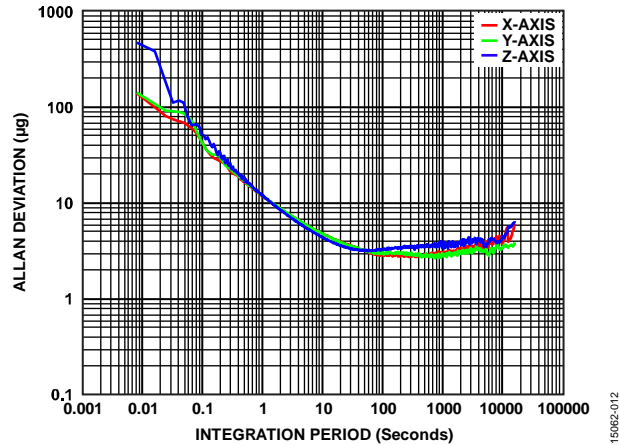

Figure 12. Accelerometer Allan Deviation

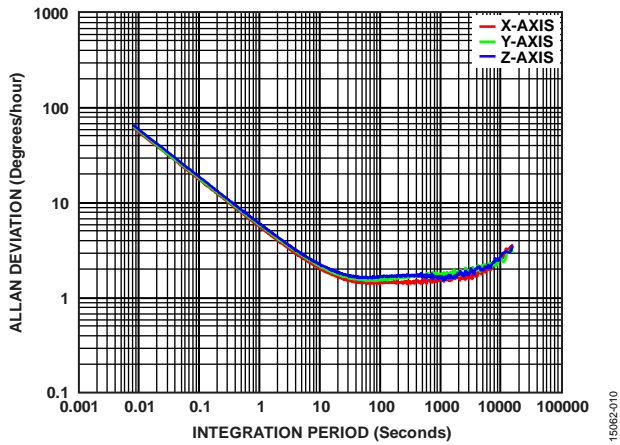

Figure 10. Gyroscope Allan Deviation, ADIS16495-2

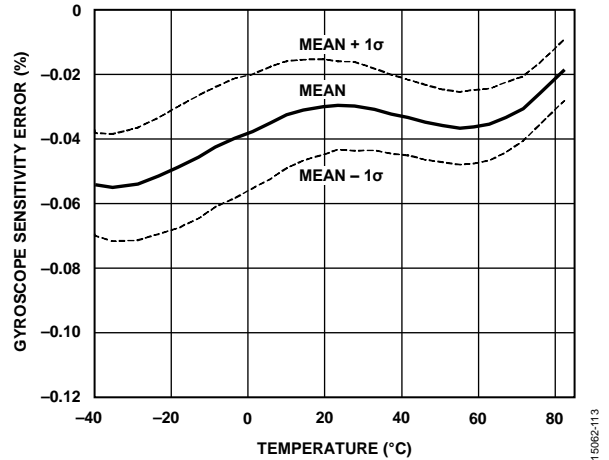

Figure 13. Gyroscope Sensitivity Error vs. Temperature, Cold to Hot, ADIS16495-1

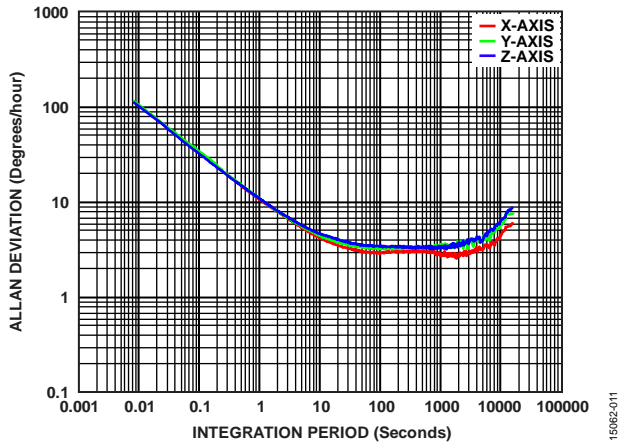

Figure 11. Gyroscope Allan Deviation, ADIS16495-3

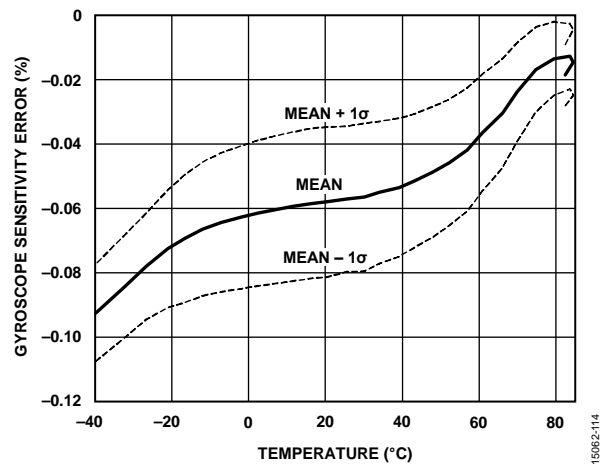

Figure 14. Gyroscope Sensitivity Error vs. Temperature, Hot to Cold, ADIS16495-1

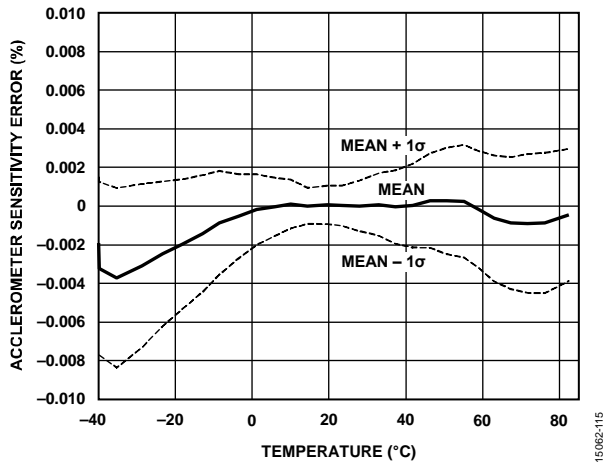

Figure 15. Accelerometer Sensitivity Error vs. Temperature, Cold to Hot, ADIS16495-1

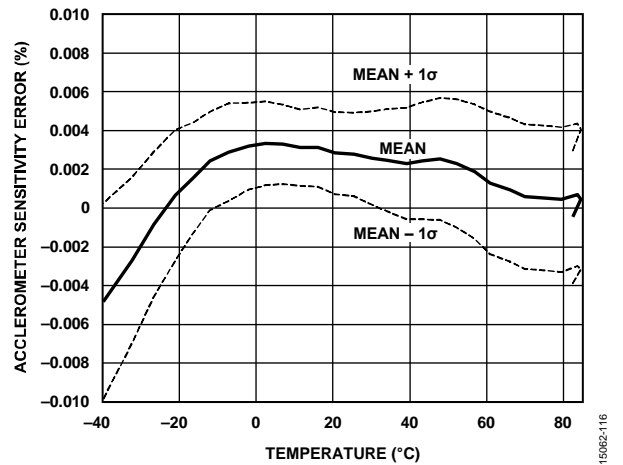

Figure 16. Accelerometer Sensitivity Error vs. Temperature, Hot to Cold, ADIS16495-1

THEORY OF OPERATION

The ADIS16495 is an autonomous sensor system that starts up on its own when it has a valid power supply. After running through its initialization process, it begins sampling, processing, and loading calibrated sensor data into the output registers, which are accessible using the SPI port.

BINERTIAL SENSOR SIGNAL CHAIN

Figure 17 shows the basic signal chain for the inertial sensors in the ADIS16495, which processes data at a rate of 4250 SPS when using the internal sample clock. Using one of the external clock options in FNCTIO_CTRL, Bits[7:4] (see Table 144) can provide some flexibility in selecting this rate.

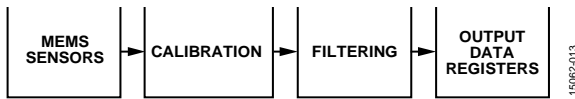

Figure 17. Signal Processing Diagram, Inertial Sensors

Gyroscope Data Sampling

The ADIS16495 produces angular rate measurements around three orthogonal axes (x, y, and z). Figure 18 shows the basic signal flow for the production of x-axis gyroscope data (same as y-axis and z-axis). This signal chain contains two digital MEMS gyroscopes (X_{G1} and X_{G2}), which have their own ADC and sample clocks (f_{SGX1} and $f_{SGX2} = 4100$ Hz) that produce data independently from each other. The sensor to sensor tolerance on this sample rate is ± 200 samples per second (SPS). Processing this data starts with combining (summation and rescale) the most recent sample from each gyroscope together by using an independent sample master frequency (f_{SM}) clock ($f_{SM} = 4250$ Hz, see Figure 18), which drives the rest of the digital signal processing (calibration, alignment, and filtering) for the gyroscopes and accelerometers.

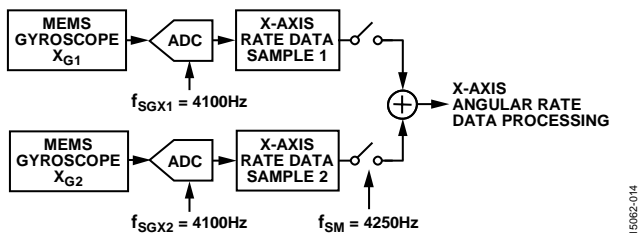

Figure 18. Gyroscope Data Sampling

Accelerometer Data Sampling

The ADIS16495 produces linear acceleration measurements along the same orthogonal axes (x, y, and z) as the gyroscopes, using the same clock (f_{SM} , see Figure 18 and Figure 19) that triggers data acquisition and subsequent processing of the gyroscope data.

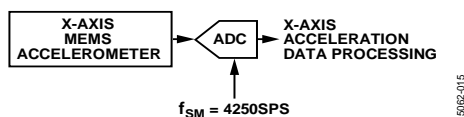

Figure 19. Accelerometer Data Sampling

External Clock Options

The ADIS16495 offers two modes of operation to control data production with an external clock: sync mode and PPS mode. In sync mode, the external clock directly controls the data sampling and production clock (f_{SM} in Figure 18 and Figure 19). In PPS mode the user can provide a lower input clock rate (1 Hz to 128 Hz) and use a scale factor (SYNC_SCALE register, see Table 154) to establish a data collection and processing rate that is between 3000 Hz and 4250 Hz for best performance.

Inertial Sensor Calibration

The calibration function for the gyroscopes and the accelerometers has two components: factory calibration and user calibration (see Figure 20).

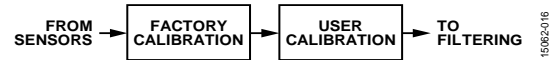

Figure 20. Gyroscope Calibration Processing

Gyroscope Factory Calibration

Gyroscope factory calibration applies the following correction formula to the data of each gyroscope:

$$\begin{bmatrix} \omega_{XC} \\ \omega_{YC} \\ \omega_{ZC} \end{bmatrix} = \begin{bmatrix} m_{11} & m_{12} & m_{13} \\ m_{21} & m_{22} & m_{23} \\ m_{31} & m_{32} & m_{33} \end{bmatrix} \times \begin{bmatrix} \omega_X \\ \omega_Y \\ \omega_Z \end{bmatrix} + \begin{bmatrix} b_X \\ b_Y \\ b_Z \end{bmatrix} + \begin{bmatrix} g_{11} & g_{12} & g_{13} \\ g_{21} & g_{22} & g_{23} \\ g_{31} & g_{32} & g_{33} \end{bmatrix} \times \begin{bmatrix} a'_X \\ a'_Y \\ a'_Z \end{bmatrix} \quad (1)$$

where:

ω_{XC} , ω_{YC} , and ω_{ZC} are the postcalibration gyroscope data.

m_{11} , m_{12} , m_{13} , m_{21} , m_{22} , m_{23} , m_{31} , m_{32} , and m_{33} are the scale and alignment correction factors.

ω_X , ω_Y , and ω_Z are the precalibration gyroscope data.

b_X , b_Y , and b_Z are the bias correction factors.

g_{11} , g_{12} , g_{13} , g_{21} , g_{22} , g_{23} , g_{31} , g_{32} , and g_{33} are the linear g correction factors.

a'_X , a'_Y , and a'_Z are the postcalibration accelerometer data.

All the correction factors in each matrix/array are derived from direct observation of the response of each gyroscope to a variety of rotation rates at multiple temperatures across the calibration temperature range ($-40^\circ\text{C} \leq T_c \leq +85^\circ\text{C}$). These correction factors are stored in the flash memory bank, but they are not available for observation. Bit 7 in the CONFIG register provides an on/off control for the linear g compensation (see Table 148). See Figure 41 for more details on the user calibration options that are available for the gyroscopes.

Accelerometer Factory Calibration

The accelerometer factory calibration applies the following correction formulas to the data of each accelerometer:

$$\begin{bmatrix} a'_X \\ a'_Y \\ a'_Z \end{bmatrix} = \begin{bmatrix} m_{11} & m_{12} & m_{13} \\ m_{21} & m_{22} & m_{23} \\ m_{31} & m_{32} & m_{33} \end{bmatrix} \times \begin{bmatrix} a_X \\ a_Y \\ a_Z \end{bmatrix} + \begin{bmatrix} b_X \\ b_Y \\ b_Z \end{bmatrix} + \begin{bmatrix} 0 & p_{12} & p_{13} \\ p_{21} & 0 & p_{23} \\ p_{31} & p_{32} & 0 \end{bmatrix} \times \begin{bmatrix} \omega_{XC}^2 \\ \omega_{YC}^2 \\ \omega_{ZC}^2 \end{bmatrix} \quad (2)$$

where:

- $a'_X, a'_Y,$ and a'_Z are the postcalibration accelerometer data.
- $m_{11}, m_{12}, m_{13}, m_{21}, m_{22}, m_{23}, m_{31}, m_{32},$ and m_{33} are the scale and alignment correction factors.
- $a_X, a_Y,$ and a_Z are the precalibration accelerometer data.
- $b_X, b_Y,$ and b_Z are the bias correction factors.
- $0, p_{12}, p_{13}, p_{21}, p_{23}, p_{31},$ and p_{32} are the point of percussion correction factors
- $\omega_{XC}^2, \omega_{YC}^2,$ and ω_{ZC}^2 are the postcalibration gyroscope data (squared).

All the correction factors in each matrix/array are derived from direct observation of the response of each accelerometer to a variety of inertial test conditions at multiple temperatures across the calibration temperature range ($-40^\circ\text{C} \leq T_c \leq +85^\circ\text{C}$). These correction factors are stored in the flash memory bank, but they are not available for observation. Bit 6 in the CONFIG register provides an on/off control for the point of percussion alignment (see Table 148). See Figure 42 for more details on the user calibration options that are available for the accelerometers.

Filtering

After calibration, the data of each inertial sensor passes through two digital filters, both of which have user configurable attributes: FIR and decimation (see Figure 21).



Figure 21. Inertial Sensor Filtering

The FIR filter includes four banks of coefficients that have 120 taps each. Register FILTR_BNK_0 (see Table 158) and Register FILTR_BNK_1 (see Table 160) provide the configuration options for the use of the FIR filters of each inertial sensor. Each FIR filter bank includes a preconfigured filter, but the user can design their own filters and write over these values using the register of each coefficient. For example, Table 163 provides the details for the FIR_COEF_A071 register, which contains Coefficient 71 in FIR Bank A. Refer to Figure 45 for the frequency response of the factory default filters. These filters do not represent any specific application environment; they are only examples.

The decimation filter averages multiple samples together to produce each register update. In this type of filter structure, the number of samples in the average is equal to the reduction in the update rate for the output data registers. See the DEC_RATE register for the user controls for this filter (see Table 150).

REGISTER STRUCTURE

All communication with the ADIS16495 involves accessing its user registers. The register structure contains both output data and control registers. The output data registers include the latest sensor data, error flags, and identification data. The control registers include sample rate, filtering, I/O, calibration, and diagnostic configuration options. All communication between the ADIS16495 and an external processor involves either reading or writing to one of the user registers.

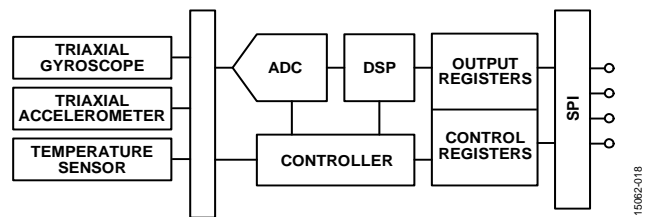
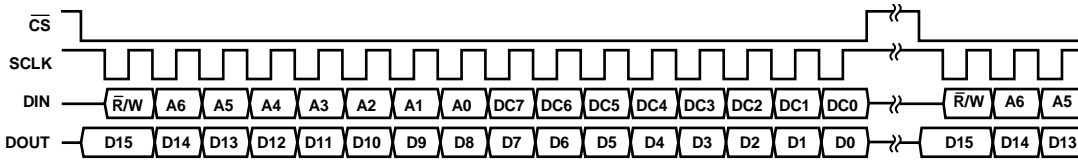

Figure 22. Basic Operation

The register structure uses a paged addressing scheme that contains 13 pages, with each page containing 64 register locations. Each register is 16 bits wide, with each byte having its own unique address within the memory map of that page. The SPI port has access to one page at a time, using the bit sequence in Figure 23. Select the page to activate for SPI access by writing its code to the PAGE_ID register. Read the PAGE_ID register to determine which page is currently active. Table 7 displays the PAGE_ID contents for each page and their basic functions. The PAGE_ID register is located at Address 0x00 on every page.

Table 7. User Register Page Assignments

| Page | PAGE_ID | Function |
|------|---------|--|
| 0 | 0x00 | Output data, clock, identification |
| 1 | 0x01 | Reserved |
| 2 | 0x02 | Calibration |
| 3 | 0x03 | Control: sample rate, filtering, I/O |
| 4 | 0x04 | Serial number, cyclic redundancy check (CRC) values |
| 5 | 0x05 | FIR Filter Bank A, Coefficient 0 to Coefficient 59 |
| 6 | 0x06 | FIR Filter Bank A, Coefficient 60 to Coefficient 119 |
| 7 | 0x07 | FIR Filter Bank B, Coefficient 0 to Coefficient 59 |
| 8 | 0x08 | FIR Filter Bank B, Coefficient 60 to Coefficient 119 |
| 9 | 0x09 | FIR Filter Bank C, Coefficient 0 to Coefficient 59 |
| 10 | 0x0A | FIR Filter Bank C, Coefficient 60 to Coefficient 119 |
| 11 | 0x0B | FIR Filter Bank D, Coefficient 0 to Coefficient 59 |
| 12 | 0x0C | FIR Filter Bank D, Coefficient 60 to Coefficient 119 |



- NOTES
1. DOUT BITS ARE PRODUCED ONLY WHEN THE PREVIOUS 16-BIT DIN SEQUENCE STARTS WITH $\bar{R}/W = 0$.
 2. WHEN \bar{CS} IS HIGH, DOUT IS IN A THREE-STATE, HIGH IMPEDANCE MODE, WHICH ALLOWS MULTIFUNCTIONAL USE OF THE LINE FOR OTHER DEVICES.

Figure 23. SPI Communication Bit Sequence

SERIAL PERIPHERAL INTERFACE

The SPI provides access to all of the user accessible registers (see Table 8) and typically connects to a compatible port on an embedded processor platform. See Figure 24 for a diagram that provides the most common connections between the ADIS16495 and an embedded processor.

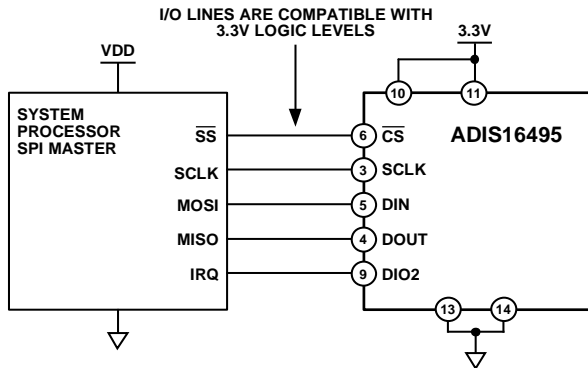

Figure 24. Electrical Connection Diagram

Table 8. Generic Master Processor Pin Names and Functions

| Mnemonic | Function |
|----------|----------------------------|
| SS | Slave select |
| IRQ | Interrupt request |
| MOSI | Master output, slave input |
| MISO | Master input, slave output |
| SCLK | Serial clock |

Embedded processors typically use control registers to configure their serial ports for communicating with SPI slave devices such as the ADIS16495. Table 9 provides a list of settings that describe the SPI protocol of the ADIS16495. The initialization routine of the master processor typically establishes these settings using firmware commands to write them into its serial control registers.

Table 9. Generic Master Processor SPI Settings

| Processor Setting | Description |
|--------------------|--|
| Master | ADIS16495 operates as slave |
| $SCLK \leq 15$ MHz | Maximum serial clock rate |
| SPI Mode 3 | CPOL = 1 (polarity), CPHA = 1 (phase) |
| MSB First Mode | Bit sequence, see Figure 23 for coding |
| 16-Bit Mode | Shift register/data length |

DATA READY

The factory default configuration provides users with a data ready (DR) signal on the DIO2 pin, which pulses low when the output data registers are updating (see Figure 25). In this configuration, connect DIO2 to an interrupt service pin on the embedded processor, which triggers data collection, when this signal pulses high. Register FNCTIO_CTRL, Bits[3:0] (see Table 144) provide some user configuration options for this function.



Figure 25. Data Ready, when FNCTIO_CTRL, Bits[3:0] = 1101 (Default)

During the start-up and reset recovery processes, the DR signal can exhibit some transient behavior before data production begins. Figure 26 provides an example of the DR behavior during startup, and Figure 27 and Figure 28 provide examples of the DR behavior during recovery from reset commands.

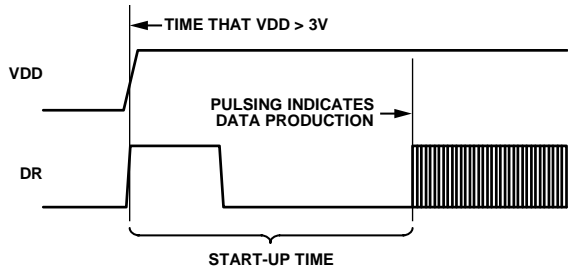

Figure 26. Data Ready Response During Startup

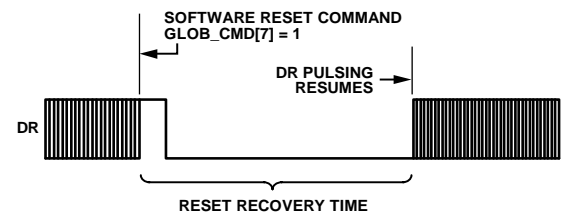

Figure 27. Data Ready Response During Reset (Register GLOB_CMD, Bit 7 = 1) Recovery

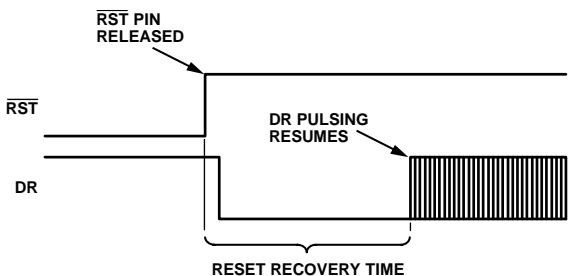

Figure 28. Data Ready Response During Reset ($\overline{RST} = 0$) Recovery

READING SENSOR DATA

Reading a single register requires two 16-bit cycles on the SPI: one to request the contents of a register and another to receive those contents. The 16-bit command code (see Figure 23) for a read request on the SPI has three parts: the read bit ($\overline{R}/W = 0$), the 7-bit address code for either address (upper or lower) of the register, Bits[A6:A0], and eight don't care bits, Bits[DC7:DC0]. Figure 29 provides an example that includes two register reads in succession. This example starts with DIN = 0x1A00, to request the contents of the Z_GYRO_OUT register, and follows with 0x1800, to request the contents of the Z_GYRO_LOW register (assuming PAGE_ID already equals 0x0000). The sequence in Figure 29 also shows full duplex mode of operation, which means that the ADIS16495 can receive requests on DIN while also transmitting data out on DOUT within the same 16-bit SPI cycle.



Figure 29. SPI Read Example

Figure 30 provides an example of the four SPI signals when reading the PROD_ID register (see Table 92) in a repeating pattern. This pattern can be helpful when troubleshooting the SPI interface setup and communications.

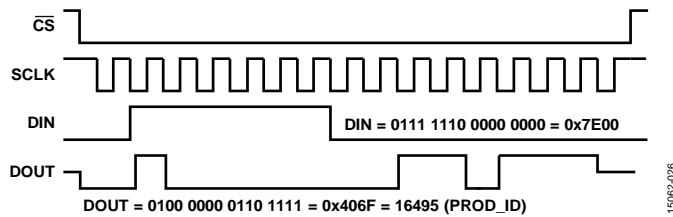

Figure 30. SPI Read Example, Second 16-Bit Sequence

Burst Read Function

The burst read function (BRF) provides a method for reading a batch of data (status, temperature, gyroscopes, accelerometers, time stamp/data counter, and CRC code), which does not require a stall time between each 16-bit segment and only requires one command on the DIN line to initiate. System processors can execute the BRF by reading the BURST_CMD register (DIN = 0x7C00) and then reading each segment of data in the response, while holding the \overline{CS} line in a low state, until after reading the last 16-bit segment of data. If the \overline{CS} line goes high before the completion of all data acquisition, the data from that read request is lost.

The BRF response on the DOUT line contains either 19 or 20 data segments (16-bits each) after the BRF request (DIN = 0x7C00), depending on the SCLK rate. Figure 5 and Table 10 illustrate the 19-segment case, while Figure 6 and Table 11 illustrate the 20-segment case.

To manage that variation, use the transition from the BURST_ID code (0xA5A5 in Table 10 and Table 11) to the

SYS_E_FLAG register, which will not be equal to 0xA5A5, as an identifier for when the ADIS16495 BRF response is starting.

Table 10. BRF Data Format ($f_{SCLK} < 3 \text{ MHz}$)¹

| Segment | DIN | DOUT |
|---------|--------|--|
| 0 | 0x7C00 | N/A |
| 1 | N/A | 0x0000 |
| 2 | N/A | 0xA5A5 (BURST_ID) |
| 3 | N/A | SYS_E_FLAG |
| 4 | N/A | TEMP_OUT |
| 5 | N/A | X_GYRO_LOW |
| 6 | N/A | X_GYRO_OUT |
| 7 | N/A | Y_GYRO_LOW |
| 8 | N/A | Y_GYRO_OUT |
| 9 | N/A | Z_GYRO_LOW |
| 10 | N/A | Z_GYRO_OUT |
| 11 | N/A | X_ACCL_LOW |
| 12 | N/A | X_ACCL_OUT |
| 13 | N/A | Y_ACCL_LOW |
| 14 | N/A | Y_ACCL_OUT |
| 15 | N/A | Z_ACCL_LOW |
| 16 | N/A | Z_ACCL_OUT |
| 17 | N/A | DATA_CNT (FNCTIO_CTRL, Bits[8:7] ≠ 11) TIME_STAMP (FNCTIO_CTRL, Bits[8:7] = 11) |
| 18 | N/A | CRC_LWR |
| 19 | N/A | CRC_UPR |

¹ N/A means not applicable.

Table 11. BRF Data Format ($f_{SCLK} > 3.6 \text{ MHz}$)¹

| Segment | DIN | DOUT |
|---------|--------|--|
| 0 | 0x7C00 | N/A |
| 1 | N/A | 0x0000 |
| 2 | N/A | 0xA5A5 (BURST_ID) |
| 3 | N/A | 0xA5A5 (BURST_ID) |
| 4 | N/A | SYS_E_FLAG |
| 5 | N/A | TEMP_OUT |
| 6 | N/A | X_GYRO_LOW |
| 7 | N/A | X_GYRO_OUT |
| 8 | N/A | Y_GYRO_LOW |
| 9 | N/A | Y_GYRO_OUT |
| 10 | N/A | Z_GYRO_LOW |
| 11 | N/A | Z_GYRO_OUT |
| 12 | N/A | X_ACCL_LOW |
| 13 | N/A | X_ACCL_OUT |
| 14 | N/A | Y_ACCL_LOW |
| 15 | N/A | Y_ACCL_OUT |
| 16 | N/A | Z_ACCL_LOW |
| 17 | N/A | Z_ACCL_OUT |
| 18 | N/A | DATA_CNT (FNCTIO_CTRL, Bits[8:7] ≠ 11) TIME_STAMP (FNCTIO_CTRL, Bits[8:7] = 11) |
| 19 | N/A | CRC_LWR |
| 20 | N/A | CRC_UPR |

¹ N/A means not applicable.

DEVICE CONFIGURATION

Each register contains 16 bits (two bytes); Bits[7:0] contain the low byte and Bits[15:8] contain the high byte. Each byte has its own unique address in the user register map (see Table 12). Updating the contents of a register requires writing to its low byte first and its high byte second. There are three parts to coding a SPI command (see Figure 23), which writes a new byte of data to a register: the write bit ($\overline{R}/W = 1$), the 7-bit address code for the byte that this command is updating, and the new data for that location, Bits[DC7:DC0]. Figure 31 provides a coding example for writing 0xFEDC to the XG_BIAS_LOW register (see Table 106), assuming that PAGE_ID already equals 0x0002.

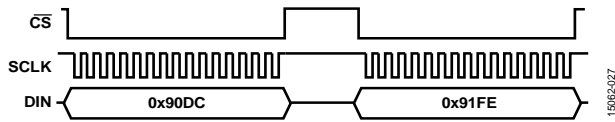

Figure 31. SPI Sequence for Writing 0xFEDC to XG_BIAS_LOW

Dual Memory Structure

The ADIS16495 uses a dual memory structure (see Figure 32), with static random access memory (SRAM) supporting real-time operation and flash memory storing operational code, calibration coefficients, and user configurable register settings. The manual flash update command (GLOB_CMD, Bit 3, see Table 142) provides a single-command method for storing user configuration settings into flash memory, for automatic recall during the next power-on or reset recovery process.

This portion of the flash memory bank has two independent banks that operate in a ping pong manner, alternating with every flash update. During power-on or reset recovery, the ADIS16495 performs a CRC on the SRAM and compares it to a CRC computation from the same memory locations in flash memory. If this memory test fails, the ADIS16495 resets and boots up from the other flash memory location. SYS_E_FLAG, Bit 2 (see Table 18) provides an error flag for detecting when the backup flash memory supported the last power-on or reset recovery. Table 12 provides a memory map for the user registers in the ADIS16495, which includes flash backup support (indicated by yes or no in the flash column).

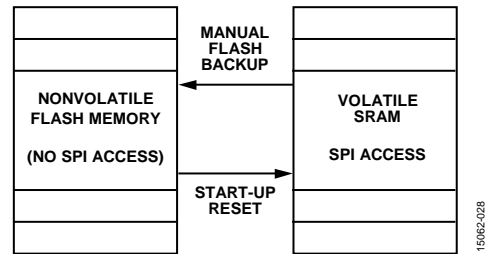

Figure 32. SRAM and Flash Memory Diagram

USER REGISTER MEMORY MAP

Table 12. User Register Memory Map¹

| Register Name | R/W | Flash Backup | PAGE_ID | Address | Default | Register Description |
|---------------|-----|--------------|---------|--------------|---------|---|
| PAGE_ID | R/W | No | 0x00 | 0x00, 0x01 | 0x0000 | Page identifier |
| Reserved | N/A | N/A | 0x00 | 0x02, 0x03 | N/A | Reserved |
| DATA_CNT | R | No | 0x00 | 0x04, 0x05 | N/A | Data counter |
| Reserved | N/A | N/A | 0x00 | 0x06, 0x07 | N/A | Reserved |
| SYS_E_FLAG | R | No | 0x00 | 0x08, 0x09 | N/A | Output, system error flags (0x0000 if no errors) |
| DIAG_STS | R | No | 0x00 | 0x0A, 0x0B | N/A | Output, self test error flags (0x0000 if no errors) |
| Reserved | N/A | N/A | 0x00 | 0x0C, 0x0D | N/A | Reserved |
| TEMP_OUT | R | No | 0x00 | 0x0E, 0x0F | N/A | Output, temperature |
| X_GYRO_LOW | R | No | 0x00 | 0x10, 0x11 | N/A | Output, x-axis gyroscope, low word |
| X_GYRO_OUT | R | No | 0x00 | 0x12, 0x13 | N/A | Output, x-axis gyroscope, high word |
| Y_GYRO_LOW | R | No | 0x00 | 0x14, 0x15 | N/A | Output, y-axis gyroscope, low word |
| Y_GYRO_OUT | R | No | 0x00 | 0x16, 0x17 | N/A | Output, y-axis gyroscope, high word |
| Z_GYRO_LOW | R | No | 0x00 | 0x18, 0x19 | N/A | Output, z-axis gyroscope, low word |
| Z_GYRO_OUT | R | No | 0x00 | 0x1A, 0x1B | N/A | Output, z-axis gyroscope, high word |
| X_ACCL_LOW | R | No | 0x00 | 0x1C, 0x1D | N/A | Output, x-axis accelerometer, low word |
| X_ACCL_OUT | R | No | 0x00 | 0x1E, 0x1F | N/A | Output, x-axis accelerometer, high word |
| Y_ACCL_LOW | R | No | 0x00 | 0x20, 0x21 | N/A | Output, y-axis accelerometer, low word |
| Y_ACCL_OUT | R | No | 0x00 | 0x22, 0x23 | N/A | Output, y-axis accelerometer, high word |
| Z_ACCL_LOW | R | No | 0x00 | 0x24, 0x25 | N/A | Output, z-axis accelerometer, low word |
| Z_ACCL_OUT | R | No | 0x00 | 0x26, 0x27 | N/A | Output, z-axis accelerometer, high word |
| TIME_STAMP | R | No | 0x00 | 0x28, 0x29 | N/A | Output, time stamp |
| CRC_LWR | R | No | 0x00 | 0x2A, 0x2B | N/A | Output, CRC-32 (32 bits), lower word |
| CRC_UPR | R | No | 0x00 | 0x2C, 0x2D | N/A | Output, CRC-32, upper word |
| Reserved | N/A | N/A | 0x00 | 0x2E to 0x3F | N/A | Reserved |
| X_DELTANG_LOW | R | No | 0x00 | 0x40, 0x41 | N/A | Output, x-axis delta angle, low word |
| X_DELTANG_OUT | R | No | 0x00 | 0x42, 0x43 | N/A | Output, x-axis delta angle, high word |
| Y_DELTANG_LOW | R | No | 0x00 | 0x44, 0x45 | N/A | Output, y-axis delta angle, low word |
| Y_DELTANG_OUT | R | No | 0x00 | 0x46, 0x47 | N/A | Output, y-axis delta angle, high word |
| Z_DELTANG_LOW | R | No | 0x00 | 0x48, 0x49 | N/A | Output, z-axis delta angle, low word |
| Z_DELTANG_OUT | R | No | 0x00 | 0x4A, 0x4B | N/A | Output, z-axis delta angle, high word |
| X_DELTVEL_LOW | R | No | 0x00 | 0x4C, 0x4D | N/A | Output, x-axis delta velocity, low word |
| X_DELTVEL_OUT | R | No | 0x00 | 0x4E, 0x4F | N/A | Output, x-axis delta velocity, high word |
| Y_DELTVEL_LOW | R | No | 0x00 | 0x50, 0x51 | N/A | Output, y-axis delta velocity, low word |
| Y_DELTVEL_OUT | R | No | 0x00 | 0x52, 0x53 | N/A | Output, y-axis delta velocity, high word |
| Z_DELTVEL_LOW | R | No | 0x00 | 0x54, 0x55 | N/A | Output, z-axis delta velocity, low word |
| Z_DELTVEL_OUT | R | No | 0x00 | 0x56, 0x57 | N/A | Output, z-axis delta velocity, high word |
| Reserved | N/A | N/A | 0x00 | 0x58 to 0x7B | N/A | Reserved |
| BURST_CMD | R | No | 0x00 | 0x7C, 0x7D | N/A | Burst read command |
| PROD_ID | R | Yes | 0x00 | 0x7E, 0x7F | 0x4071 | Output, product identification (16495d) |
| Reserved | N/A | N/A | 0x01 | 0x00 to 0x7F | N/A | Reserved |
| PAGE_ID | R/W | No | 0x02 | 0x00, 0x01 | 0x0000 | Page identifier |
| Reserved | N/A | N/A | 0x02 | 0x02, 0x03 | N/A | Reserved |
| X_GYRO_SCALE | R/W | Yes | 0x02 | 0x04, 0x05 | 0x0000 | Calibration, scale, x-axis gyroscope |
| Y_GYRO_SCALE | R/W | Yes | 0x02 | 0x06, 0x07 | 0x0000 | Calibration, scale, y-axis gyroscope |
| Z_GYRO_SCALE | R/W | Yes | 0x02 | 0x08, 0x09 | 0x0000 | Calibration, scale, z-axis gyroscope |
| X_ACCL_SCALE | R/W | Yes | 0x02 | 0x0A, 0x0B | 0x0000 | Calibration, scale, x-axis accelerometer |
| Y_ACCL_SCALE | R/W | Yes | 0x02 | 0x0C, 0x0D | 0x0000 | Calibration, scale, y-axis accelerometer |
| Z_ACCL_SCALE | R/W | Yes | 0x02 | 0x0E, 0x0F | 0x0000 | Calibration, scale, z-axis accelerometer |
| XG_BIAS_LOW | R/W | Yes | 0x02 | 0x10, 0x11 | 0x0000 | Calibration, bias, gyroscope, x-axis, low word |

| Register Name | R/W | Flash Backup | PAGE_ID | Address | Default | Register Description |
|----------------------------|-----|--------------|---------|--------------|---------------------|---|
| XG_BIAS_HIGH | R/W | Yes | 0x02 | 0x12, 0x13 | 0x0000 | Calibration, bias, gyroscope, x-axis, high word |
| YG_BIAS_LOW | R/W | Yes | 0x02 | 0x14, 0x15 | 0x0000 | Calibration, bias, gyroscope, y-axis, low word |
| YG_BIAS_HIGH | R/W | Yes | 0x02 | 0x16, 0x17 | 0x0000 | Calibration, bias, gyroscope, y-axis, high word |
| ZG_BIAS_LOW | R/W | Yes | 0x02 | 0x18, 0x19 | 0x0000 | Calibration, bias, gyroscope, z-axis, low word |
| ZG_BIAS_HIGH | R/W | Yes | 0x02 | 0x1A, 0x1B | 0x0000 | Calibration, bias, gyroscope, z-axis, high word |
| XA_BIAS_LOW | R/W | Yes | 0x02 | 0x1C, 0x1D | 0x0000 | Calibration, bias, accelerometer, x-axis, low word |
| XA_BIAS_HIGH | R/W | Yes | 0x02 | 0x1E, 0x1F | 0x0000 | Calibration, bias, accelerometer, x-axis, high word |
| YA_BIAS_LOW | R/W | Yes | 0x02 | 0x20, 0x21 | 0x0000 | Calibration, bias, accelerometer, y-axis, low word |
| YA_BIAS_HIGH | R/W | Yes | 0x02 | 0x22, 0x23 | 0x0000 | Calibration, bias, accelerometer, y-axis, high word |
| ZA_BIAS_LOW | R/W | Yes | 0x02 | 0x24, 0x25 | 0x0000 | Calibration, bias, accelerometer, z-axis, low word |
| ZA_BIAS_HIGH | R/W | Yes | 0x02 | 0x26, 0x27 | 0x0000 | Calibration, bias, accelerometer, z-axis, high word |
| Reserved | N/A | N/A | 0x02 | 0x28 to 0x73 | 0x0000 | Reserved |
| USER_SCR_1 | R/W | Yes | 0x02 | 0x74, 0x75 | 0x0000 | User Scratch Register 1 |
| USER_SCR_2 | R/W | Yes | 0x02 | 0x76, 0x77 | 0x0000 | User Scratch Register 2 |
| USER_SCR_3 | R/W | Yes | 0x02 | 0x78, 0x79 | 0x0000 | User Scratch Register 3 |
| USER_SCR_4 | R/W | Yes | 0x02 | 0x7A, 0x7B | 0x0000 | User Scratch Register 4 |
| FLSHCNT_LOW | R | Yes | 0x02 | 0x7C, 0x7D | N/A | Diagnostic, flash memory count, low word |
| FLSHCNT_HIGH | R | Yes | 0x02 | 0x7E, 0x7F | N/A | Diagnostic, flash memory count, high word |
| PAGE_ID | R/W | No | 0x03 | 0x00, 0x01 | 0x0000 | Page identifier |
| GLOB_CMD | W | No | 0x03 | 0x02, 0x03 | N/A | Control, global commands |
| Reserved | N/A | N/A | 0x03 | 0x04, 0x05 | N/A | Reserved |
| FNCTIO_CTRL | R/W | Yes | 0x03 | 0x06, 0x07 | 0x000D | Control, I/O pins, functional definitions |
| GPIO_CTRL | R/W | Yes | 0x03 | 0x08, 0x09 | 0x00X0 ² | Control, I/O pins, general-purpose |
| CONFIG | R/W | Yes | 0x03 | 0x0A, 0x0B | 0x00C0 | Control, clock, and miscellaneous correction |
| DEC_RATE | R/W | Yes | 0x03 | 0x0C, 0x0D | 0x0000 | Control, output sample rate decimation |
| NULL_CNFG | R/W | Yes | 0x03 | 0x0E, 0x0F | 0x070A | Control, automatic bias correction configuration |
| SYNC_SCALE | R/W | Yes | 0x03 | 0x10, 0x11 | 0x109A | Control, input clock scaling (PPS mode) |
| RANG_MDL | R | N/A | 0x03 | 0x12, 0x13 | N/A | Measurement range (model-specific) Identifier |
| Reserved | N/A | N/A | 0x03 | 0x14, 0x15 | N/A | Reserved |
| FILTR_BNK_0 | R/W | Yes | 0x03 | 0x16, 0x17 | 0x0000 | Filter selection |
| FILTR_BNK_1 | R/W | Yes | 0x03 | 0x18, 0x19 | 0x0000 | Filter selection |
| Reserved | N/A | N/A | 0x03 | 0x1A to 0x77 | N/A | Reserved |
| FIRM_REV | R | Yes | 0x03 | 0x78, 0x79 | N/A | Firmware revision |
| FIRM_DM | R | Yes | 0x03 | 0x7A, 0x7B | N/A | Firmware programming date (day/month) |
| FIRM_Y | R | Yes | 0x03 | 0x7C, 0x7D | N/A | Firmware programming date (year) |
| BOOT_REV | R | Yes | 0x03 | 0x7E, 0x7F | N/A | Boot loader revision |
| PAGE_ID | R/W | No | 0x04 | 0x00, 0x01 | 0x0000 | Page identifier |
| Reserved | N/A | N/A | 0x04 | 0x02, 0x03 | N/A | Reserved |
| CAL_SIGTR_LWR | R | Yes | 0x04 | 0x04, 0x05 | N/A | Signature CRC, calibration coefficients, low word |
| CAL_SIGTR_UPR | R | Yes | 0x04 | 0x06, 0x07 | N/A | Signature CRC, calibration coefficients, high word |
| CAL_DRVTN_LWR | R | No | 0x04 | 0x08, 0x09 | N/A | Real-time CRC, calibration coefficients, low word |
| CAL_DRVTN_UPR | R | No | 0x04 | 0x0A, 0x0B | N/A | Real-time CRC, calibration coefficients, high word |
| CODE_SIGTR_LWR | R | Yes | 0x04 | 0x0C, 0x0D | N/A | Signature CRC, program code, low word |
| CODE_SIGTR_UPR | R | Yes | 0x04 | 0x0E, 0x0F | N/A | Signature CRC, program code, high word |
| CODE_DRVTN_LWR | R | No | 0x04 | 0x10, 0x11 | N/A | Real-time CRC, program code, low word |
| CODE_DRVTN_UPR | R | No | 0x04 | 0x12, 0x13 | N/A | Real-time CRC, program code, high word |
| Reserved | N/A | N/A | 0x04 | 0x1C to 0x1F | N/A | Reserved |
| SERIAL_NUM | R | Yes | 0x04 | 0x20, 0x21 | N/A | Serial number |
| Reserved | N/A | N/A | 0x04 | 0x22 to 0x7F | N/A | Reserved |
| PAGE_ID | R/W | No | 0x05 | 0x00, 0x01 | 0x0000 | Page identifier |
| Reserved | N/A | N/A | 0x05 | 0x02 to 0x07 | N/A | Reserved |
| FIR_COEF_Axxx ³ | R/W | Yes | 0x05 | 0x08 to 0x7F | N/A | FIR Filter Bank A: Coefficient 0 through Coefficient 59 |

| Register Name | R/W | Flash Backup | PAGE_ID | Address | Default | Register Description |
|----------------------------|-----|--------------|---------|--------------|---------|---|
| PAGE_ID | R/W | No | 0x06 | 0x00, 0x01 | 0x0000 | Page identifier |
| Reserved | N/A | N/A | 0x06 | 0x02 to 0x07 | N/A | Reserved |
| FIR_COEF_Axxx ³ | R/W | Yes | 0x06 | 0x08 to 0x7F | N/A | FIR Filter Bank A: Coefficient 60 through Coefficient 119 |
| PAGE_ID | R/W | No | 0x07 | 0x00, 0x01 | 0x0000 | Page identifier |
| Reserved | N/A | N/A | 0x07 | 0x02 to 0x07 | N/A | Reserved |
| FIR_COEF_Bxxx ⁴ | R/W | Yes | 0x07 | 0x08 to 0x7F | N/A | FIR Filter Bank B: Coefficient 0 through Coefficient 59 |
| PAGE_ID | R/W | No | 0x08 | 0x00, 0x01 | 0x0000 | Page identifier |
| Reserved | N/A | N/A | 0x08 | 0x02 to 0x07 | N/A | Reserved |
| FIR_COEF_Bxxx ⁴ | R/W | Yes | 0x08 | 0x08 to 0x7F | N/A | FIR Filter Bank B: Coefficient 60 through Coefficient 119 |
| PAGE_ID | R/W | No | 0x09 | 0x00, 0x01 | 0x0000 | Page identifier |
| Reserved | N/A | N/A | 0x09 | 0x02 to 0x07 | N/A | Reserved |
| FIR_COEF_Cxxx ⁵ | R/W | Yes | 0x09 | 0x08 to 0x7F | N/A | FIR Filter Bank C: Coefficient 0 through Coefficient 59 |
| PAGE_ID | R/W | No | 0x0A | 0x00, 0x01 | 0x0000 | Page identifier |
| Reserved | N/A | N/A | 0x0A | 0x02 to 0x07 | N/A | Reserved |
| FIR_COEF_Cxxx ⁵ | R/W | Yes | 0x0A | 0x08 to 0x7F | N/A | FIR Filter Bank C: Coefficient 60 through Coefficient 119 |
| PAGE_ID | R/W | No | 0x0B | 0x00, 0x01 | 0x0000 | Page identifier |
| Reserved | N/A | N/A | 0x0B | 0x02 to 0x07 | N/A | Reserved |
| FIR_COEF_Dxxx ⁶ | R/W | Yes | 0x0B | 0x08 to 0x7F | N/A | FIR Filter Bank D: Coefficient 0 through Coefficient 59 |
| PAGE_ID | R/W | No | 0x0C | 0x00, 0x01 | 0x0000 | Page identifier |
| Reserved | N/A | N/A | 0x0C | 0x02 to 0x07 | N/A | Reserved |
| FIR_COEF_Dxxx ⁶ | R/W | Yes | 0x0C | 0x08 to 0x7F | N/A | FIR Filter Bank D: Coefficient 60 through Coefficient 119 |

¹ N/A means not applicable.

² The GPIO_CTRL[7:4] bits reflect the logic levels on the DIOx lines and do not have a default setting.

³ See the FIR Filter Bank A, FIR_COEF_A000 to FIR_COEF_A119 section for additional information.

⁴ See the FIR Filter Bank B, FIR_COEF_B000 to FIR_COEF_B119 section for additional information.

⁵ See the FIR Filter Bank C, FIR_COEF_C000 to FIR_COEF_C119 section for additional information.

⁶ See the FIR Filter Bank D, FIR_COEF_D000 to FIR_COEF_D119 section for additional information.

USER REGISTER DEFINITIONS

PAGE NUMBER (PAGE_ID)

The contents in the PAGE_ID register (see Table 13 and Table 14) contain the current page setting, and provide a control for selecting another page for SPI access. For example, set DIN = 0x8002 to select Page 2 for SPI-based user access. See Table 12 for the page assignments associated with each user accessible register.

Table 13. PAGE_ID Register Definition

| Page | Addresses | Default | Access | Flash Backup |
|------|------------|---------|--------|--------------|
| 0x00 | 0x00, 0x01 | 0x0000 | R/W | No |

Table 14. PAGE_ID Bit Descriptions

| Bits | Description |
|--------|--------------------------------------|
| [15:0] | Page number, binary numerical format |

DATA/SAMPLE COUNTER (DATA_CNT)

The DATA_CNT register (see Table 15 and Table 16) is a continuous, real-time, sample counter. It starts at 0x0000, increments every time the output data registers update, and wraps around from 0xFFFF (65,535 decimal) to 0x0000 (0 decimal).

Table 15. DATA_CNT Register Definition

| Page | Addresses | Default | Access | Flash Backup |
|------|------------|----------------|--------|--------------|
| 0x00 | 0x04, 0x05 | Not applicable | R | No |

Table 16. DATA_CNT Bit Descriptions

| Bits | Description |
|--------|-----------------------------|
| [15:0] | Data counter, binary format |

STATUS/ERROR FLAG INDICATORS (SYS_E_FLAG)

The SYS_E_FLAG register (see Table 17 and Table 18) provides various error flags. Reading this register causes all of its bits to return to 0, with the exception of Bit 7. If an error condition persists, its flag (bit) automatically returns to an alarm value of 1.

Table 17. SYS_E_FLAG Register Definition

| Page | Addresses | Default | Access | Flash Backup |
|------|------------|---------|--------|--------------|
| 0x00 | 0x08, 0x09 | 0x0000 | R | No |

Table 18. SYS_E_FLAG Bit Descriptions

| Bits | Description |
|--------|---|
| 15 | Watchdog timer flag. A 1 indicates the ADIS16495 automatically resets itself to clear an issue. |
| [14:9] | Not used. |
| 8 | Sync error. A 1 indicates the sample timing is not scaling correctly, when operating in PPS mode (FNCTIO_CTRL, Bit 8 = 1, see Table 144). When this error occurs, verify that the input sync frequency is correct and that SYNC_SCALE (see Table 154) has the correct value. |
| 7 | Processing overrun. A 1 indicates the occurrence of a processing overrun. Initiate a reset to recover. Replace the ADIS16495 if this error persists. |
| 6 | Flash memory update failure. A 1 indicates that the most recent flash memory update failed (GLOB_CMD, Bit 3, see Table 142). Repeat the test and replace the ADIS16495 if this error persists. |
| 5 | Sensor failure. A 1 indicates failure in at least one of the inertial sensors. Read the DIAG_STS register (see Table 20) to determine which sensor is failing. Replace the ADIS16495 if the error persists, when it is operating in static inertial conditions. |
| 4 | Not used. |
| 3 | SPI communication error. A 1 indicates that the total number of SCLK cycles is not equal to an integer multiple of 16. Repeat the previous communication sequence to recover. Persistence in this error can indicate a weakness in the SPI service from the master processor. |
| 2 | SRAM error condition. A 1 indicates a failure in the CRC (period = 20 ms) between the SRAM and flash memory. Initiate a reset to recover. Replace the ADIS16495 if this error persists. |
| 1 | Boot memory failure. A 1 indicates that the device booted up using code from the backup memory bank. Replace the ADIS16495 if this error occurs. |
| 0 | Not used. |

SELF TEST ERROR FLAGS (DIAG_STS)

SYS_E_FLAG, Bit 5 (see Table 18) contains the pass/fail result (0 = pass) for the on demand self test (ODST) operations, whereas the DIAG_STS register (see Table 19 and Table 20) contains pass/fail flags (0 = pass) for each inertial sensor. Reading the DIAG_STS register causes all of its bits to restore to 0. The bits in DIAG_STS return to 1 if the error conditions persists.

Table 19. DIAG_STS Register Definition

| Page | Addresses | Default | Access | Flash Backup |
|------|------------|---------|--------|--------------|
| 0x00 | 0x0A, 0x0B | 0x0000 | R | No |

Table 20. DIAG_STS Bit Descriptions

| Bits | Description (Default = 0x0000) |
|--------|---|
| [15:6] | Not used |
| 5 | Self test failure, z-axis accelerometer (1 means failure) |
| 4 | Self test failure, y-axis accelerometer (1 means failure) |
| 3 | Self test failure, x-axis accelerometer (1 means failure) |
| 2 | Self test failure, z-axis gyroscope (1 means failure) |
| 1 | Self test failure, y-axis gyroscope (1 means failure) |
| 0 | Self test failure, x-axis gyroscope (1 means failure) |

INTERNAL TEMPERATURE (TEMP_OUT)

The TEMP_OUT register (see Table 21 and Table 22) provides a coarse measurement of the temperature inside of the ADIS16495. This data is useful for monitoring relative changes in the thermal environment. Table 23 provides several examples of the data format for the TEMP_OUT register.

Table 21. TEMP_OUT Register Definition

| Page | Addresses | Default | Access | Flash Backup |
|------|------------|----------------|--------|--------------|
| 0x00 | 0x0E, 0x0F | Not applicable | R | No |

Table 22. TEMP_OUT Bit Descriptions

| Bits | Description |
|--------|--|
| [15:0] | Temperature data; twos complement, 1°C per 80 LSB, 25°C = 0x0000 |

Table 23. TEMP_OUT Data Format Examples

| Temperature (°C) | Decimal | Hex | Binary |
|------------------|---------|--------|---------------------|
| +85 | +4800 | 0x12C0 | 0001 0010 1100 0000 |
| +25 + 2/80 | +2 | 0x0002 | 0000 0000 0000 0010 |
| +25 + 1/80 | +1 | 0x0001 | 0000 0000 0000 0001 |
| +25 | 0 | 0x0000 | 0000 0000 0000 0000 |
| +25 - 1/80 | -1 | 0xFFFF | 1111 1111 1111 1111 |
| +25 - 2/80 | -2 | 0xFFFE | 1111 1111 1111 1110 |
| -40 | -5200 | 0xEBB0 | 1110 1011 1011 0000 |

GYROSCOPE DATA

The gyroscopes in the ADIS16495 measure the angular rate of rotation around three orthogonal axes (x, y, and z). Figure 34 shows the orientation of each gyroscope axis, which defines the direction of rotation that produces a positive response in each of the angular rate measurements.

Each gyroscope has two output data registers. Figure 33 shows how these two registers combine to support a 32-bit, twos complement data format for the x-axis gyroscope measurements. This format also applies to the y-axis and z-axis as well.

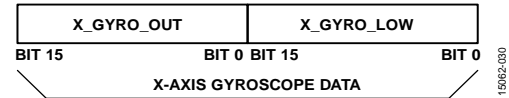

Figure 33. Gyroscope Output Data Structure

Gyroscope Measurement Range/Scale Factor

Table 24 provides the range and scale factor (K_G) for the angular rate (gyroscope) measurements in each ADIS16495 model.

Table 24. Gyroscope Measurement Range and Scale Factors

| Model | Range | Scale Factor, K_G |
|-------------|-----------------------------|---------------------|
| ADIS16495-1 | $\pm 125^\circ/\text{sec}$ | 0.00625°/sec/LSB |
| ADIS16495-2 | $\pm 450^\circ/\text{sec}$ | 0.025°/sec/LSB |
| ADIS16495-3 | $\pm 2000^\circ/\text{sec}$ | 0.1°/sec/LSB |

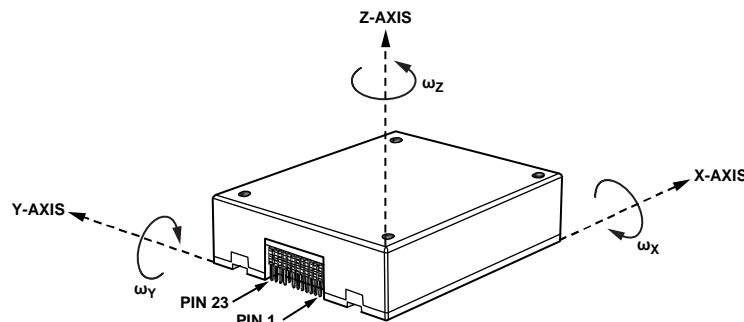

Figure 34. Gyroscope Axis and Polarity Assignments

Gyroscope Data Formatting

Table 25 and Table 26 offer various numerical examples that demonstrate the format of the rotation rate data in both 16-bit and 32-bit formats. See Table 24 for the scale factor (K_G) associated with each ADIS16495 model.

Table 25. 16-Bit Gyroscope Data Format Examples

| Rotation Rate (°/sec) | Decimal | Hex | Binary |
|-----------------------|---------|--------|---------------------|
| +10000 K_G | +10,000 | 0x2710 | 0010 0111 0001 0000 |
| +2 K_G | +2 | 0x0002 | 0000 0000 0000 0010 |
| + K_G | +1 | 0x0001 | 0000 0000 0000 0001 |
| 0°/sec | 0 | 0x0000 | 0000 0000 0000 0000 |
| - K_G | -1 | 0xFFFF | 1111 1111 1111 1111 |
| -2 K_G | -2 | 0xFFFE | 1111 1111 1111 1110 |
| -10000 K_G | -10,000 | 0xD8F0 | 1101 1000 1111 0000 |

Table 26. 32-Bit Gyroscope Data Format Examples

| Rotation Rate (°/sec) | Decimal | Hexadecimal |
|-----------------------|--------------|-------------|
| +10000 K_G | +655,360,000 | 0x27100000 |
| + $K_G/2^{15}$ | +2 | 0x00000002 |
| + $K_G/2^{16}$ | +1 | 0x00000001 |
| 0 | 0 | 0x00000000 |
| - $K_G/2^{16}$ | -1 | 0xFFFFFFFF |
| - $K_G/2^{15}$ | -2 | 0xFFFFFFFF |
| -10000 K_G | -655,360,000 | 0xD8F00000 |

X-Axis Gyroscope (X_GYRO_LOW, X_GYRO_OUT)

The X_GYRO_LOW (see Table 27 and Table 28) and X_GYRO_OUT (see Table 29 and Table 30) registers contain the gyroscope data for the x-axis.

Table 27. X_GYRO_LOW Register Definition

| Page | Addresses | Default | Access | Flash Backup |
|------|------------|----------------|--------|--------------|
| 0x00 | 0x10, 0x11 | Not applicable | R | No |

Table 28. X_GYRO_LOW Bit Descriptions

| Bits | Description |
|--------|---------------------------------|
| [15:0] | X-axis gyroscope data; low word |

Table 29. X_GYRO_OUT Register Definition

| Page | Addresses | Default | Access | Flash Backup |
|------|------------|----------------|--------|--------------|
| 0x00 | 0x12, 0x13 | Not applicable | R | No |

Table 30. X_GYRO_OUT Bit Descriptions

| Bits | Description |
|--------|---|
| [15:0] | X-axis gyroscope data; high word; twos complement, 0°/sec = 0x0000, see Table 24 for scale factor |

Y-Axis Gyroscope (Y_GYRO_LOW, Y_GYRO_OUT)

The Y_GYRO_LOW (see Table 31 and Table 32) and Y_GYRO_OUT (see Table 33 and Table 34) registers contain the gyroscope data for the y-axis.

Table 31. Y_GYRO_LOW Register Definition

| Page | Addresses | Default | Access | Flash Backup |
|------|------------|----------------|--------|--------------|
| 0x00 | 0x14, 0x15 | Not applicable | R | No |

Table 32. Y_GYRO_LOW Bit Descriptions

| Bits | Description |
|--------|---------------------------------|
| [15:0] | Y-axis gyroscope data; low word |

Table 33. Y_GYRO_OUT Register Definition

| Page | Addresses | Default | Access | Flash Backup |
|------|------------|----------------|--------|--------------|
| 0x00 | 0x16, 0x17 | Not applicable | R | No |

Table 34. Y_GYRO_OUT Bit Descriptions

| Bits | Description |
|--------|---|
| [15:0] | Y-axis gyroscope data; high word; twos complement, 0°/sec = 0x0000, see Table 24 for scale factor |

Z-Axis Gyroscope (Z_GYRO_LOW, Z_GYRO_OUT)

The Z_GYRO_LOW (see Table 35 and Table 36) and Z_GYRO_OUT (see Table 37 and Table 38) registers contain the gyroscope data for the z-axis.

Table 35. Z_GYRO_LOW Register Definition

| Page | Addresses | Default | Access | Flash Backup |
|------|------------|----------------|--------|--------------|
| 0x00 | 0x18, 0x19 | Not applicable | R | No |

Table 36. Z_GYRO_LOW Bit Descriptions

| Bits | Description |
|--------|---|
| [15:0] | Z-axis gyroscope data; additional resolution bits |

Table 37. Z_GYRO_OUT Register Definition

| Page | Addresses | Default | Access | Flash Backup |
|------|------------|----------------|--------|--------------|
| 0x00 | 0x1A, 0x1B | Not applicable | R | No |

Table 38. Z_GYRO_OUT Bit Descriptions

| Bits | Description |
|--------|---|
| [15:0] | Z-axis gyroscope data; high word; twos complement, 0°/sec = 0x0000, see Table 24 for scale factor |

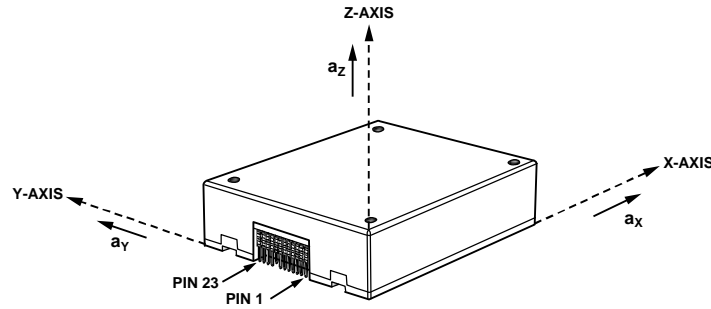

Figure 35. Accelerometer Axis and Polarity Assignments

ACCELERATION DATA

The accelerometers in the ADIS16495 measure both dynamic and static (response to gravity) acceleration along three orthogonal axes (x, y, and z). Figure 35 shows the orientation of each accelerometer axis, which defines the direction of linear acceleration that produces a positive response in each of the angular rate measurements.

Each accelerometer has two output data registers. Figure 36 shows how these two registers combine to support a 32-bit, twos complement data format for the x-axis accelerometer measurements. This format also applies to the y-axis and z-axis.

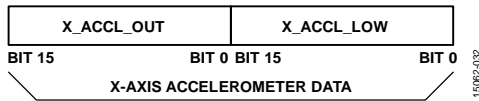

Figure 36. Accelerometer Output Data Structure

X-Axis Accelerometer (X_ACCL_LOW, X_ACCL_OUT)

The X_ACCL_LOW (see Table 39 and Table 40) and X_ACCL_OUT (see Table 41 and Table 42) registers contain the accelerometer data for the x-axis.

Table 39. X_ACCL_LOW Register Definition

| Page | Addresses | Default | Access | Flash Backup |
|------|------------|----------------|--------|--------------|
| 0x00 | 0x1C, 0x1D | Not applicable | R | No |

Table 40. X_ACCL_LOW Bit Descriptions

| Bits | Description |
|--------|-------------------------------------|
| [15:0] | X-axis accelerometer data; low word |

Table 41. X_ACCL_OUT Register Definition

| Page | Addresses | Default | Access | Flash Backup |
|------|------------|----------------|--------|--------------|
| 0x00 | 0x1E, 0x1F | Not applicable | R | No |

Table 42. X_ACCL_OUT Descriptions

| Bits | Description |
|--------|--|
| [15:0] | X-axis accelerometer data, high word; twos complement, $\pm 8 g$ range; $0 g = 0x0000$, 1 LSB = 0.25 mg |

Y-Axis Accelerometer (Y_ACCL_LOW, Y_ACCL_OUT)

The Y_ACCL_LOW (see Table 43 and Table 44) and Y_ACCL_OUT (see Table 45 and Table 46) registers contain the accelerometer data for the y-axis.

Table 43. Y_ACCL_LOW Register Definition

| Page | Addresses | Default | Access | Flash Backup |
|------|------------|----------------|--------|--------------|
| 0x00 | 0x20, 0x21 | Not applicable | R | No |

Table 44. Y_ACCL_LOW Bit Descriptions

| Bits | Description |
|--------|-------------------------------------|
| [15:0] | Y-axis accelerometer data; low word |

Table 45. Y_ACCL_OUT Register Definition

| Page | Addresses | Default | Access | Flash Backup |
|------|------------|----------------|--------|--------------|
| 0x00 | 0x22, 0x23 | Not applicable | R | No |

Table 46. Y_ACCL_OUT Bit Descriptions

| Bits | Description |
|--------|--|
| [15:0] | Y-axis accelerometer data, high word; twos complement, $\pm 8 g$ range, $0 g = 0x0000$, 1 LSB = 0.25 mg |

Z-Axis Accelerometer (Z_ACCL_LOW, Z_ACCL_OUT)

The Z_ACCL_LOW (see Table 47 and Table 48) and Z_ACCL_OUT (see Table 49 and Table 50) registers contain the accelerometer data for the z-axis.

Table 47. Z_ACCL_LOW Register Definition

| Page | Addresses | Default | Access | Flash Backup |
|------|------------|----------------|--------|--------------|
| 0x00 | 0x24, 0x25 | Not applicable | R | No |

Table 48. Z_ACCL_LOW Bit Descriptions

| Bits | Description |
|--------|-------------------------------------|
| [15:0] | Z-axis accelerometer data; low word |

Table 49. Z_ACCL_OUT Register Definition

| Page | Addresses | Default | Access | Flash Backup |
|------|------------|----------------|--------|--------------|
| 0x00 | 0x26, 0x27 | Not applicable | R | No |

Table 50. Z_ACCL_OUT Bit Descriptions

| Bits | Description |
|--------|--|
| [15:0] | Z-axis accelerometer data, high word; twos complement, $\pm 8 g$ range, $0 g = 0x0000$, 1 LSB = 0.25 mg |

Accelerometer Resolution

Table 51 and Table 52 offer various numerical examples that demonstrate the format of the linear acceleration data in both 16-bit and 32-bit formats.

Table 51. 16-Bit Accelerometer Data Format Examples

| Acceleration | Decimal | Hex | Binary |
|--------------|---------|--------|---------------------|
| +8 g | +32,000 | 0x7D00 | 0111 1101 0000 0000 |
| +0.5 mg | +2 | 0x0002 | 0000 0000 0000 0010 |
| +0.25 mg | +1 | 0x0001 | 0000 0000 0000 0001 |
| 0 mg | 0 | 0x0000 | 0000 0000 0000 0000 |
| -0.25 mg | -1 | 0xFFFF | 1111 1111 1111 1111 |
| -0.5 mg | -2 | 0xFFFE | 1111 1111 1111 1110 |
| -8 g | -32,000 | 0x8300 | 1000 0011 0000 0000 |

Table 52. 32-Bit Accelerometer Data Format Examples

| Acceleration | Decimal | Hexadecimal |
|--------------------------|----------------|-------------|
| +8 g | +2,097,152,000 | 0x7D000000 |
| +0.25/2 ¹⁵ mg | +2 | 0x00000002 |
| +0.25/2 ¹⁶ mg | +1 | 0x00000001 |
| 0 mg | 0 | 0x00000000 |
| -0.25/2 ¹⁶ mg | -1 | 0xFFFFFFFF |
| -0.25/2 ¹⁵ mg | -2 | 0xFFFFFFFFE |
| -8 g | -2,097,152,000 | 0x83000000 |

TIME STAMP

When using PPS mode (FNCTIO_CTRL, Bits[8:7] = 11 (binary), see Table 144), the TIME_STAMP register (see Table 53 and Table 54) provides the time between the most recent pulse on the input clock signal and the most recent data update.

Table 53. TIME_STAMP Register Definition

| Page | Addresses | Default | Access | Flash Backup |
|------|------------|----------------|--------|--------------|
| 0x00 | 0x28, 0x29 | Not applicable | R | No |

Table 54. TIME_STAMP Bit Descriptions

| Bits | Description |
|--------|--|
| [15:0] | Time stamp, binary format. 1 LSB = 1/f _{SM} (see Figure 18, Figure 19, and Table 154). The leading edge of the input clock pulse resets the value in this register to 0x0000. |

When using the decimation filter (DEC_RATE > 0x0000), the value in the TIME_STAMP register represents the time of the first sample (taken at the rate of f_{SM}, per Figure 18 and Figure 19).

For example, when DEC_RATE = 0x0003, the decimation filter reduces the update by a factor of four and the TIME_STAMP register updates to 1 (decimal) during the first data update, then

to 5 on the second update, 9 on the third update, for example, until the next clock signal pulse.

CYCLICAL REDUNDANCY CHECK (CRC-32)

The ADIS16495 performs a CRC-32 computation, using the output data registers (see Table 55).

Table 55. CRC-32 Source Data and Example Values

| Register | Example Value |
|------------|---------------|
| SYS_E_FLAG | 0x0000 |
| TEMP_OUT | 0x083A |
| X_GYRO_LOW | 0x0000 |
| X_GYRO_OUT | 0xFFFF7 |
| Y_GYRO_LOW | 0x0000 |
| Y_GYRO_OUT | 0xFFFE |
| Z_GYRO_LOW | 0x0000 |
| Z_GYRO_OUT | 0x0001 |
| X_ACCL_LOW | 0x5001 |
| X_ACCL_OUT | 0x0003 |
| Y_ACCL_LOW | 0xE00A |
| Y_ACCL_OUT | 0x0015 |
| Z_ACCL_LOW | 0xC009 |
| Z_ACCL_OUT | 0x0320 |
| TIME_STAMP | 0x8A54 |

The CRC_LWR (see Table 56 and Table 57) and CRC_UPR (see Table 58 and Table 59) registers contain the result of the CRC-32 computation. For the example, the register values from Table 55 are,

$$CRC_LWR = 0x15B4$$

$$CRC_UPR = 0xB6C8$$

Table 56. CRC_LWR Register Definition

| Page | Addresses | Default | Access | Flash Backup |
|------|------------|----------------|--------|--------------|
| 0x00 | 0x2A, 0x2B | Not applicable | R | No |

Table 57. CRC_LWR Bit Definitions

| Bits | Description |
|--------|--|
| [15:0] | CRC-32 code from most recent BRf, lower word |

Table 58. CRC_UPR Register Definition

| Page | Addresses | Default | Access | Flash Backup |
|------|------------|----------------|--------|--------------|
| 0x00 | 0x2C, 0x2D | Not applicable | R | No |

Table 59. CRC_UPR Bit Definitions

| Bits | Description |
|--------|--|
| [15:0] | CRC-32 code from most recent BRf, upper word |

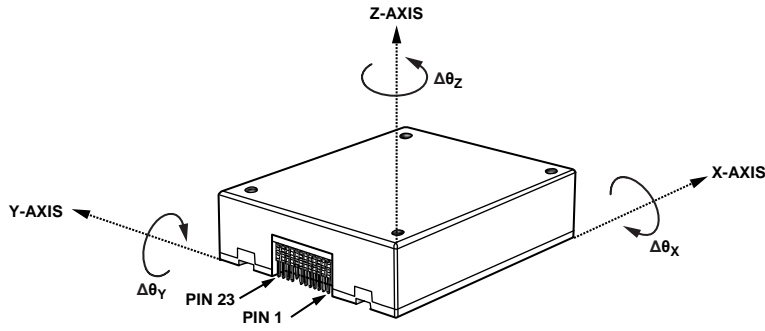

Figure 37. Delta Angle Axis and Polarity Assignments

DELTA ANGLES

In addition to the angular rate of rotation (gyroscope) measurements around each axis (x, y, and z), the ADIS16495 also provides delta angle measurements that represent a computation of angular displacement between each sample update. Figure 37 shows the orientation of each delta angle output, which defines the direction of rotation that produces a positive response in each of the angular displacement (delta angle) measurements.

The delta angle outputs represent an integration of the gyroscope measurements and use the following formula for all three axes (x-axis displayed):

$$\Delta\theta_{x,nD} = \frac{1}{2f_s} \times \sum_{d=0}^{D-1} (\omega_{x,nD+d} + \omega_{x,nD+d-1})$$

where:

- $\Delta\theta_x$ is the delta angle measurement for the x-axis.
- D is the decimation rate = DEC_RATE + 1 (see Table 150).
- f_s is the sample rate.
- d is the incremental variable in the summation formula.
- ω_x is the x-axis rate of rotation (gyroscope).
- n is the sample time, prior to the decimation filter.

When using the internal sample clock, f_s is equal to 4250 SPS. When using the external clock option, f_s is equal to the frequency of the external clock. The range in the delta angle registers accommodates the maximum rate of rotation (100°/sec), the nominal sample rate (4250 SPS), and an update rate of 1 Hz (DEC_RATE = 0x1099; divide by 4249 plus 1, see Table 150), all at the same time. When using an external clock that is higher than 4250 SPS, reduce the DEC_RATE setting to avoid over-ranging the delta angle registers.

Each axis of the delta angle measurements has two output data registers. Figure 38 shows how these two registers combine to support a 32-bit, twos complement data format for the x-axis delta angle measurements. This format also applies to the y-axis and z-axis.

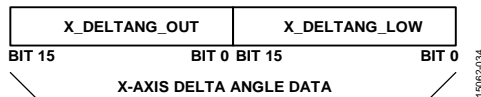

Figure 38. Delta Angle Output Data Structure

Delta Angle Measurement Range

Table 60 offers the measurement range and scale factor for each ADIS16495 model.

Table 60. Delta Angle Measurement Range and Scale Factor

| Model | Measurement Range, $\pm\Delta\theta_{MAX}$ |
|-------------|--|
| ADIS16495-1 | $\pm 360^\circ$ |
| ADIS16495-2 | $\pm 720^\circ$ |
| ADIS16495-3 | $\pm 2160^\circ$ |

X-Axis Delta Angle (X_DELTANG_LOW, X_DELTANG_OUT)

The X_DELTANG_LOW (see Table 61 and Table 62) and X_DELTANG_OUT (see Table 63 and Table 64) registers contain the delta angle data for the x-axis.

Table 61. X_DELTANG_LOW Register Definitions

| Page | Addresses | Default | Access | Flash Backup |
|------|------------|----------------|--------|--------------|
| 0x00 | 0x40, 0x41 | Not applicable | R | No |

Table 62. X_DELTANG_LOW Bit Descriptions

| Bits | Description |
|--------|-----------------------------------|
| [15:0] | X-axis delta angle data; low word |

Table 63. X_DELTANG_OUT Register Definitions

| Page | Addresses | Default | Access | Flash Backup |
|------|------------|----------------|--------|--------------|
| 0x00 | 0x42, 0x43 | Not applicable | R | No |

Table 64. X_DELTANG_OUT Bit Descriptions

| Bits | Description |
|--------|---|
| [15:0] | X-axis delta angle data; twos complement, $0^\circ = 0x0000$, 1 LSB = $\Delta\theta_{MAX}/2^{15}$ (see Table 60 for $\Delta\theta_{MAX}$) |

Y-Axis Delta Angle (Y_DELTANG_LOW, Y_DELTANG_OUT)

The Y_DELTANG_LOW (see Table 65 and Table 66) and Y_DELTANG_OUT (see Table 67 and Table 68) registers contain the delta angle data for the y-axis.

Table 65. Y_DELTANG_LOW Register Definitions

| Page | Addresses | Default | Access | Flash Backup |
|------|------------|----------------|--------|--------------|
| 0x00 | 0x44, 0x45 | Not applicable | R | No |

Table 66. Y_DELTANG_LOW Bit Descriptions

| Bits | Description |
|--------|-----------------------------------|
| [15:0] | Y-axis delta angle data; low word |

Table 67. Y_DELTANG_OUT Register Definitions

| Page | Addresses | Default | Access | Flash Backup |
|------|------------|----------------|--------|--------------|
| 0x00 | 0x46, 0x47 | Not applicable | R | No |

Table 68. Y_DELTANG_OUT Bit Descriptions

| Bits | Description |
|--------|---|
| [15:0] | Y-axis delta angle data; twos complement, 0° = 0x0000, 1 LSB = Δθ _{MAX} /2 ¹⁵ (see Table 60 for Δθ _{MAX}) |

Z-Axis Delta Angle (Z_DELTANG_LOW, Z_DELTANG_OUT)

The Z_DELTANG_LOW (see Table 69 and Table 70) and Z_DELTANG_OUT (see Table 71 and Table 72) registers contain the delta angle data for the z-axis.

Table 69. Z_DELTANG_LOW Register Definitions

| Page | Addresses | Default | Access | Flash Backup |
|------|------------|----------------|--------|--------------|
| 0x00 | 0x48, 0x49 | Not applicable | R | No |

Table 70. Z_DELTANG_LOW Bit Descriptions

| Bits | Description |
|--------|-----------------------------------|
| [15:0] | Z-axis delta angle data; low word |

Table 71. Z_DELTANG_OUT Register Definitions

| Page | Addresses | Default | Access | Flash Backup |
|------|------------|----------------|--------|--------------|
| 0x00 | 0x4A, 0x4B | Not applicable | R | No |

Table 72. Z_DELTANG_OUT Bit Descriptions

| Bits | Description |
|--------|---|
| [15:0] | Z-axis delta angle data; twos complement, 0° = 0x0000, 1 LSB = Δθ _{MAX} /2 ¹⁵ (see Table 60 for Δθ _{MAX}) |

Delta Angle Resolution

Table 73 and Table 74 shows various numerical examples that demonstrate the format of the delta angle data in both 16-bit and 32-bit formats.

Table 73. 16-Bit Delta Angle Data Format Examples

| Delta Angle (°) | Decimal | Hex | Binary |
|---|---------|--------|---------------------|
| Δθ _{MAX} × (2 ¹⁵ - 1)/2 ¹⁵ | +32,767 | 0x7FFF | 0111 1111 1110 1111 |
| +Δθ _{MAX} /2 ¹⁴ | +2 | 0x0002 | 0000 0000 0000 0010 |
| +Δθ _{MAX} /2 ¹⁵ | +1 | 0x0001 | 0000 0000 0000 0001 |
| 0 | 0 | 0x0000 | 0000 0000 0000 0000 |
| -Δθ _{MAX} /2 ¹⁵ | -1 | 0xFFFF | 1111 1111 1111 1111 |
| -Δθ _{MAX} /2 ¹⁴ | -2 | 0xFFFE | 1111 1111 1111 1110 |
| -Δθ _{MAX} | -32,768 | 0x8000 | 1000 0000 0000 0000 |

Table 74. 32-Bit Delta Angle Data Format Examples

| Delta Angle (°) | Decimal | Hex |
|--|----------------|-------------|
| +Δθ _{MAX} × (2 ³¹ - 1)/2 ³¹ | +2,147,483,647 | 0x7FFFFFFF |
| +Δθ _{MAX} /2 ³⁰ | +2 | 0x00000002 |
| +Δθ _{MAX} 2000/2 ³¹ | +1 | 0x00000001 |
| 0 | 0 | 0x00000000 |
| -Δθ _{MAX} /2 ³¹ | -1 | 0xFFFFFFFF |
| -Δθ _{MAX} /2 ³⁰ | -2 | 0xFFFFFFFFE |
| -Δθ _{MAX} | -2,147,483,648 | 0x80000000 |

DELTA VELOCITY

In addition to the linear acceleration measurements along each axis (x, y, and z), the ADIS16495 also provides delta velocity measurements that represent a computation of linear velocity change between each sample update. Figure 40 shows the orientation of each delta-velocity measurement, which defines the direction of linear velocity increase that produces a positive response in each of the delta velocity rate measurements.

The delta velocity outputs represent an integration of the acceleration measurements and use the following formula for all three axes (x-axis displayed):

$$\Delta V_{x,nD} = \frac{1}{2f_s} \times \sum_{d=0}^{D-1} (a_{x,nD+d} + a_{x,nD+d-1})$$

where:

ΔV_x is the delta velocity measurement for the x-axis.

D is the decimation rate = DEC_RATE + 1 (see Table 150).

f_s is the sample rate.

d is the incremental variable in the summation formula.

a_x is the x-axis rate of acceleration (accelerometer).

n is the sample time, prior to the decimation filter.

When using the internal sample clock, f_s is equal to 4250 SPS. When using the external clock option, f_s is equal to the frequency of the external clock. The range in the delta velocity registers accommodates the maximum linear acceleration (8 g), the nominal sample rate (4250 SPS), and an update rate of 1 Hz ($DEC_RATE = 0x1099$; divide by 4249 plus 1, see Table 150), all at the same time. When using an external clock that is higher than 4250 SPS, reduce the DEC_RATE setting to avoid overranging the delta velocity registers.

Each axis of the delta velocity measurements has two output data registers. Figure 39 shows how these two registers combine to support 32-bit, twos complement data format for the delta velocity measurements along the x-axis. This format also applies to the y-axis and z-axis.

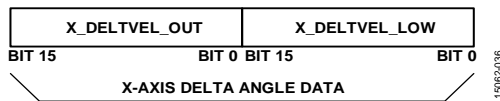

Figure 39. Delta Angle Output Data Structure

X-Axis Delta Velocity (X_DELTVEL_LOW, X_DELTVEL_OUT)

The X_DELTVEL_LOW (see Table 75 and Table 76) and X_DELTVEL_OUT (see Table 77 and Table 78) registers contain the delta velocity data for the x-axis.

Table 75. X_DELTVEL_LOW Register Definitions

| Page | Addresses | Default | Access | Flash Backup |
|------|------------|----------------|--------|--------------|
| 0x00 | 0x4C, 0x4D | Not applicable | R | No |

Table 76. X_DELTVEL_LOW Bit Definitions

| Bits | Description |
|--------|-----------------------------------|
| [15:0] | X-axis delta angle data; low word |

Table 77. X_DELTVEL_OUT Register Definitions

| Page | Addresses | Default | Access | Flash Backup |
|------|------------|----------------|--------|--------------|
| 0x00 | 0x4E, 0x4F | Not applicable | R | No |

Table 78. X_DELTVEL_OUT Bit Definitions

| Bits | Description |
|--------|--|
| [15:0] | X-axis delta velocity data, high word; twos complement, ± 100 m/sec range, 0 m/sec = 0x0000; 1 LSB = $100 \text{ m/sec} \div 2^{15} = \sim 3.052 \text{ mm/sec}$ |

Y-Axis Delta Velocity (Y_DELTVEL_LOW, Y_DELTVEL_OUT)

The Y_DELTVEL_LOW (see Table 79 and Table 80) and Y_DELTVEL_OUT (see Table 81 and Table 82) registers contain the delta velocity data for the y-axis.

Table 79. Y_DELTVEL_LOW Register Definitions

| Page | Addresses | Default | Access | Flash Backup |
|------|------------|----------------|--------|--------------|
| 0x00 | 0x50, 0x51 | Not applicable | R | No |

Table 80. Y_DELTVEL_LOW Bit Definitions

| Bits | Description |
|--------|-----------------------------------|
| [15:0] | Y-axis delta angle data; low word |

Table 81. Y_DELTVEL_OUT Register Definitions

| Page | Addresses | Default | Access | Flash Backup |
|------|------------|----------------|--------|--------------|
| 0x00 | 0x52, 0x53 | Not applicable | R | No |

Table 82. Y_DELTVEL_OUT Bit Definitions

| Bits | Description |
|--------|--|
| [15:0] | Y-axis delta velocity data, high word; twos complement, ± 100 m/sec range, 0 m/sec = 0x0000; 1 LSB = $100 \text{ m/sec} \div 2^{15} = \sim 3.052 \text{ mm/sec}$ |

Z-Axis Delta Velocity (Z_DELTVEL_LOW, Z_DELTVEL_OUT)

The Z_DELTVEL_LOW (see Table 83 and Table 84) and Z_DELTVEL_OUT (see Table 85 and Table 86) registers contain the delta velocity data for the z-axis.

Table 83. Z_DELTVEL_LOW Register Definitions

| Page | Addresses | Default | Access | Flash Backup |
|------|------------|----------------|--------|--------------|
| 0x00 | 0x54, 0x55 | Not applicable | R | No |

Table 84. Z_DELTVEL_LOW Bit Definitions

| Bits | Description |
|--------|-----------------------------------|
| [15:0] | Z-axis delta angle data; low word |

Table 85. Z_DELTVEL_OUT Register Definitions

| Page | Addresses | Default | Access | Flash Backup |
|------|------------|----------------|--------|--------------|
| 0x00 | 0x56, 0x57 | Not applicable | R | No |

Table 86. Z_DELTVEL_OUT Bit Definitions

| Bits | Description |
|--------|--|
| [15:0] | Z-axis delta velocity data, high word; twos complement, ± 100 m/sec range, 0 m/sec = 0x0000; 1 LSB = $100 \text{ m/sec} \div 2^{15} = \sim 3.052 \text{ mm/sec}$ |

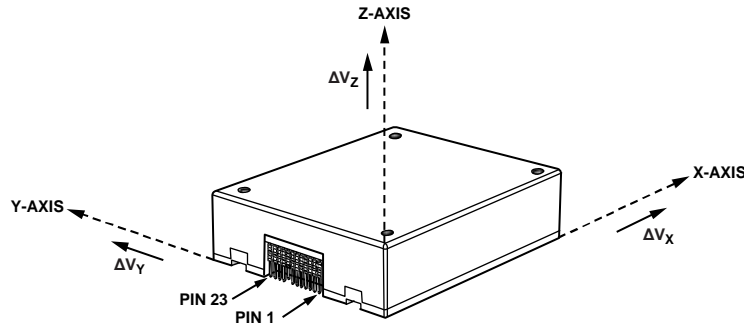

Figure 40. Delta Velocity Axis and Polarity Assignments

Delta Velocity Resolution

Table 87 and Table 88 offer various numerical examples that demonstrate the format of the delta angle data in both 16-bit and 32-bit formats.

Table 87. 16-Bit Delta Velocity Data Format Examples

| Velocity (m/sec) | Decimal | Hex | Binary |
|-----------------------------------|---------|---------|---------------------|
| $+100 \times (2^{15} - 1)/2^{15}$ | +32,767 | 0x7FFF | 0111 1111 1110 1111 |
| $+100/2^{14}$ | +2 | 0x0002 | 0000 0000 0000 0010 |
| $+100/2^{15}$ | +1 | 0x0001 | 0000 0000 0000 0001 |
| 0 | 0 | 0x0000 | 0000 0000 0000 0000 |
| $-100/2^{15}$ | -1 | 0xFFFF | 1111 1111 1111 1111 |
| $-100/2^{14}$ | -2 | 0xFFFFE | 1111 1111 1111 1110 |
| -100 | -32,768 | 0x8000 | 1000 0000 0000 0000 |

Table 88. 32-Bit Delta Angle Data Format Examples

| Velocity (m/sec) | Decimal | Hex |
|-----------------------------------|----------------|-------------|
| $+100 \times (2^{31} - 1)/2^{31}$ | +2,147,483,647 | 0x7FFFFFFF |
| $+100/2^{30}$ | +2 | 0x00000002 |
| $+100/2^{31}$ | +1 | 0x00000001 |
| 0 | 0 | 0x00000000 |
| $-100/2^{31}$ | -1 | 0xFFFFFFFF |
| $-100/2^{30}$ | -2 | 0xFFFFFFFFE |
| -100 | -2,147,483,648 | 0x80000000 |

Burst Read Command, BURST_CMD

Reading the BURST_CMD register (see Table 89 and Table 90) starts the BRF. See Table 10, Table 11, Figure 5, and Figure 6 for more information on the BRF function.

Table 89. BURST_CMD Register Definitions

| Page | Addresses | Default | Access | Flash Backup |
|------|------------|----------------|--------|--------------|
| 0x00 | 0x7C, 0x7D | Not Applicable | R | No |

Table 90. BURST_CMD Bit Definitions

| Bits | Description |
|--------|-----------------------------|
| [15:0] | Burst read command register |

Product Identification, PROD_ID

The PROD_ID register (see Table 91 and Table 92) contains the numerical portion of the device number (16,495). See Figure 30 for an example of how to use a looping read of this register to validate the integrity of the communication.

Table 91. PROD_ID Register Definitions

| Page | Addresses | Default | Access | Flash Backup |
|------|------------|---------|--------|--------------|
| 0x00 | 0x7E, 0x7F | 0x406F | R | Yes |

Table 92. PROD_ID Bit Definitions

| Bits | Description |
|--------|---------------------------------|
| [15:0] | Product identification = 0x406F |

USER BIAS/SCALE ADJUSTMENT

The signal chain of each inertial sensor (accelerometers, gyroscopes) includes application of unique correction formulas that come from extensive characterization of bias, sensitivity, alignment, and response to linear acceleration (gyroscopes) over a temperature range of -40°C to +85°C for the ADIS16495. These correction formulas are not accessible, but the user does have the opportunity to adjust the bias and the scale factor, for each sensor individually, through user accessible registers. These correction factors follow immediately after the factory derived correction formulas in the signal chain, which processes at a rate of 4250 Hz when using the internal sample clock (see f_{SM} in Figure 18 and Figure 19).

Gyroscope Scale Adjustment, X_GYRO_SCALE

The X_GYRO_SCALE register (see Table 93 and Table 94) provides the user with the opportunity to adjust the scale factor for the x-axis gyroscopes. See Figure 41 for an illustration of how this scale factor influences the x-axis gyroscope data.

Table 93. X_GYRO_SCALE Register Definitions

| Page | Addresses | Default | Access | Flash Backup |
|------|------------|---------|--------|--------------|
| 0x02 | 0x04, 0x05 | 0x0000 | R/W | Yes |

Table 94. X_GYRO_SCALE Bit Definitions

| Bits | Description |
|--------|--|
| [15:0] | X-axis gyroscope scale correction; twos complement, 0x0000 = unity gain, 1 LSB = $1 \div 2^{15} = \sim 0.003052\%$ |

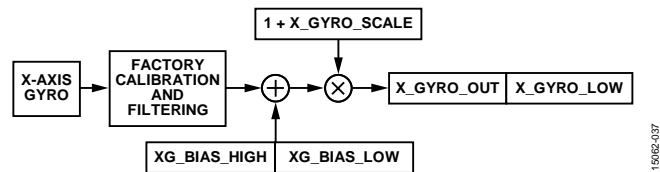

Figure 41. User Bias/Scale Adjustment Registers in Gyroscope Signal Path

Gyroscope Scale Adjustment, Y_GYRO_SCALE

The Y_GYRO_SCALE register (see Table 95 and Table 96) allows the user to adjust the scale factor for the y-axis gyroscopes. This register influences the y-axis gyroscope measurements in the same manner that X_GYRO_SCALE influences the x-axis gyroscope measurements (see Figure 41).

Table 95. Y_GYRO_SCALE Register Definitions

| Page | Addresses | Default | Access | Flash Backup |
|------|------------|---------|--------|--------------|
| 0x02 | 0x06, 0x07 | 0x0000 | R/W | Yes |

Table 96. Y_GYRO_SCALE Bit Definitions

| Bits | Description |
|--------|--|
| [15:0] | Y-axis gyroscope scale correction; twos complement, 0x0000 = unity gain, 1 LSB = $1 \div 2^{15} = \sim 0.003052\%$ |

Gyroscope Scale Adjustment, Z_GYRO_SCALE

The Z_GYRO_SCALE register (see Table 97 and Table 98) allows the user to adjust the scale factor for the z-axis gyroscopes. This register influences the z-axis gyroscope measurements in the same manner that X_GYRO_SCALE influences the x-axis gyroscope measurements (see Figure 41).

Table 97. Z_GYRO_SCALE Register Definitions

| Page | Addresses | Default | Access | Flash Backup |
|------|------------|---------|--------|--------------|
| 0x02 | 0x08, 0x09 | 0x0000 | R/W | Yes |

Table 98. Z_GYRO_SCALE Bit Definitions

| Bits | Description |
|--------|--|
| [15:0] | Z-axis gyroscope scale correction; twos complement, 0x0000 = unity gain, 1 LSB = $1 \div 2^{15} = \sim 0.003052\%$ |

Accelerometer Scale Adjustment, X_ACCL_SCALE

The X_ACCL_SCALE register (see Table 99 and Table 100) allows users to adjust the scale factor for the x-axis accelerometers. See Figure 42 for an illustration of how this scale factor influences the x-axis accelerometer data.

Table 99. X_ACCL_SCALE Register Definitions

| Page | Addresses | Default | Access | Flash Backup |
|------|------------|---------|--------|--------------|
| 0x02 | 0x0A, 0x0B | 0x0000 | R/W | Yes |

Table 100. X_ACCL_SCALE Bit Definitions

| Bits | Description |
|--------|--|
| [15:0] | X-axis accelerometer scale correction; twos complement, 0x0000 = unity gain, 1 LSB = $1 \div 2^{15} = \sim 0.003052\%$ |

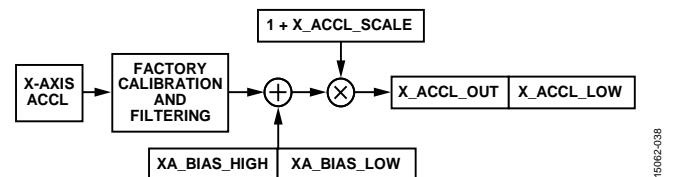

Figure 42. User Bias/Scale Adjustment Registers in Accelerometer Signal Path

Accelerometer Scale Adjustment, Y_ACCL_SCALE

The Y_ACCL_SCALE register (see Table 101 and Table 102) allows the user to adjust the scale factor for the y-axis accelerometers. This register influences the y-axis accelerometer measurements in the same manner that X_ACCL_SCALE influences the x-axis accelerometer measurements (see Figure 42).

Table 101. Y_ACCL_SCALE Register Definitions

| Page | Addresses | Default | Access | Flash Backup |
|------|------------|---------|--------|--------------|
| 0x02 | 0x0C, 0x0D | 0x0000 | R/W | Yes |

Table 102. Y_ACCL_SCALE Bit Definitions

| Bits | Description |
|--------|--|
| [15:0] | Y-axis accelerometer scale correction; twos complement, 0x0000 = unity gain, 1 LSB = $1 \div 2^{15} = \sim 0.003052\%$ |

Accelerometer Scale Adjustment, Z_ACCL_SCALE

The Z_ACCL_SCALE register (see Table 103 and Table 104) allows the user to adjust the scale factor for the z-axis accelerometers. This register influences the z-axis accelerometer measurements in the same manner that X_ACCL_SCALE influences the x-axis accelerometer measurements (see Figure 42).

Table 103. Z_ACCL_SCALE Register Definitions

| Page | Addresses | Default | Access | Flash Backup |
|------|------------|---------|--------|--------------|
| 0x02 | 0x0E, 0x0F | 0x0000 | R/W | Yes |

Table 104. Z_ACCL_SCALE Bit Definitions

| Bits | Description |
|--------|--|
| [15:0] | Z-axis accelerometer scale correction; twos complement, 0x0000 = unity gain, 1 LSB = $1 \div 2^{15} = \sim 0.003052\%$ |

Gyroscope Bias Adjustment, XG_BIAS_LOW, XG_BIAS_HIGH

The XG_BIAS_LOW (see Table 105 and Table 106) and XG_BIAS_HIGH (see Table 107 and Table 108) registers combine to allow the user to adjust the bias of the x-axis gyroscopes. The digital format examples in Table 25 also apply to the XG_BIAS_HIGH register, and the digital format examples in Table 26 apply to the number that comes from combining the XG_BIAS_LOW and XG_BIAS_HIGH registers. See Figure 41 for an illustration of how these two registers combine and influence the x-axis gyroscope measurements.

Table 105. XG_BIAS_LOW Register Definitions

| Page | Addresses | Default | Access | Flash Backup |
|------|------------|---------|--------|--------------|
| 0x02 | 0x10, 0x11 | 0x0000 | R/W | Yes |

Table 106. XG_BIAS_LOW Bit Definitions

| Bits | Description |
|--------|--|
| [15:0] | X-axis gyroscope offset correction, low word; twos complement, 0°/sec = 0x0000, 1 LSB = $K_G \div 2^{16}$ (see Table 24) |

Table 107. XG_BIAS_HIGH Register Definitions

| Page | Addresses | Default | Access | Flash Backup |
|------|------------|---------|--------|--------------|
| 0x02 | 0x12, 0x13 | 0x0000 | R/W | Yes |

Table 108. XG_BIAS_HIGH Bit Definitions

| Bits | Description |
|--------|--|
| [15:0] | X-axis gyroscope offset correction, high word twos complement, 0°/sec = 0x0000, 1 LSB = K_G (see Table 24) |

Gyroscope Bias Adjustment, YG_BIAS_LOW, YG_BIAS_HIGH

The YG_BIAS_LOW (see Table 109 and Table 110) and YG_BIAS_HIGH (see Table 111 and Table 112) registers combine to allow users to adjust the bias of the y-axis gyroscopes. The digital format examples in Table 25 also apply to the

YG_BIAS_HIGH register, and the digital format examples in Table 26 apply to the number that comes from combining the YG_BIAS_LOW and YG_BIAS_HIGH registers. These registers influence the y-axis gyroscope measurements in the same manner that the XG_BIAS_LOW and XG_BIAS_HIGH registers influence the x-axis gyroscope measurements (see Figure 41).

Table 109. YG_BIAS_LOW Register Definitions

| Page | Addresses | Default | Access | Flash Backup |
|------|------------|---------|--------|--------------|
| 0x02 | 0x14, 0x15 | 0x0000 | R/W | Yes |

Table 110. YG_BIAS_LOW Bit Definitions

| Bits | Description |
|--------|--|
| [15:0] | Y-axis gyroscope offset correction, low word; twos complement, 0°/sec = 0x0000, 1 LSB = $K_G \div 2^{16}$ (see Table 24) |

Table 111. YG_BIAS_HIGH Register Definitions

| Page | Addresses | Default | Access | Flash Backup |
|------|------------|---------|--------|--------------|
| 0x02 | 0x16, 0x17 | 0x0000 | R/W | Yes |

Table 112. YG_BIAS_HIGH Bit Definitions

| Bits | Description |
|--------|--|
| [15:0] | Y-axis gyroscope offset correction, high word twos complement, 0°/sec = 0x0000, 1 LSB = K_G (See Table 24) |

Gyroscope Bias Adjustment, ZG_BIAS_LOW, ZG_BIAS_HIGH

The ZG_BIAS_LOW (see Table 113 and Table 114) and ZG_BIAS_HIGH (see Table 115 and Table 116) registers combine to allow users to adjust the bias of the z-axis gyroscopes. The digital format examples in Table 25 also apply to the ZG_BIAS_HIGH register, and the digital format examples in Table 26 apply to the number that comes from combining the ZG_BIAS_LOW and ZG_BIAS_HIGH registers. These registers influence the z-axis gyroscope measurements in the same manner that the XG_BIAS_LOW and XG_BIAS_HIGH registers influence the x-axis gyroscope measurements (see Figure 41).

Table 113. ZG_BIAS_LOW Register Definitions

| Page | Addresses | Default | Access | Flash Backup |
|------|------------|---------|--------|--------------|
| 0x02 | 0x18, 0x19 | 0x0000 | R/W | Yes |

Table 114. ZG_BIAS_LOW Bit Definitions

| Bits | Description |
|--------|--|
| [15:0] | Z-axis gyroscope offset correction, low word; twos complement, 0°/sec = 0x0000, 1 LSB = $K_G \div 2^{16}$ (see Table 24) |

Table 115. ZG_BIAS_HIGH Register Definitions

| Page | Addresses | Default | Access | Flash Backup |
|------|------------|---------|--------|--------------|
| 0x02 | 0x1A, 0x1B | 0x0000 | R/W | Yes |

Table 116. ZG_BIAS_HIGH Bit Definitions

| Bits | Description |
|--------|---|
| [15:0] | Z-axis gyroscope offset correction, high word twos complement, $0^\circ/\text{sec} = 0x0000$, 1 LSB = K_G (See Table 24) |

Accelerometer Bias Adjustment, XA_BIAS_LOW, XA_BIAS_HIGH

The XA_BIAS_LOW (see Table 117 and Table 118) and XA_BIAS_HIGH (see Table 119 and Table 120) registers combine to allow the user to adjust the bias of the x-axis accelerometers. The digital format examples in Table 51 also apply to the XA_BIAS_HIGH register and the digital format examples in Table 52 apply to the number that comes from combining the XA_BIAS_LOW and XA_BIAS_HIGH registers. See Figure 42 for an illustration of how these two registers combine and influence the x-axis gyroscope measurements.

Table 117. XA_BIAS_LOW Register Definitions

| Page | Addresses | Default | Access | Flash Backup |
|------|------------|---------|--------|--------------|
| 0x02 | 0x1C, 0x1D | 0x0000 | R/W | Yes |

Table 118. XA_BIAS_LOW Bit Definitions

| Bits | Description |
|--------|---|
| [15:0] | X-axis accelerometer offset correction, low word, twos complement, $0 g = 0x0000$, 1 LSB = $0.25 \text{ mg} \div 2^{16}$ |

Table 119. XA_BIAS_HIGH Register Definitions

| Page | Addresses | Default | Access | Flash Backup |
|------|------------|---------|--------|--------------|
| 0x02 | 0x1E, 0x1F | 0x0000 | R/W | Yes |

Table 120. XA_BIAS_HIGH Bit Definitions

| Bits | Description |
|--------|--|
| [15:0] | X-axis accelerometer offset correction, high word, twos complement, $0 g = 0x0000$, 1 LSB = 0.25 mg |

Accelerometer Bias Adjustment, YA_BIAS_LOW, YA_BIAS_HIGH

The YA_BIAS_LOW (see Table 121 and Table 122) and YA_BIAS_HIGH (see Table 123 and Table 124) registers combine to allow the user to adjust the bias of the y-axis accelerometers. The digital format examples in Table 51 also apply to the YA_BIAS_HIGH register, and the digital format examples in Table 52 apply to the number that comes from combining the YA_BIAS_LOW and YA_BIAS_HIGH registers. These registers influence the y-axis accelerometer measurements in the same manner that the XA_BIAS_LOW and XA_BIAS_HIGH registers influence the x-axis accelerometer measurements (see Figure 42).

Table 121. YA_BIAS_LOW Register Definitions

| Page | Addresses | Default | Access | Flash Backup |
|------|------------|---------|--------|--------------|
| 0x02 | 0x20, 0x21 | 0x0000 | R/W | Yes |

Table 122. YA_BIAS_LOW Bit Definitions

| Bits | Description |
|--------|---|
| [15:0] | Y-axis accelerometer offset correction, low word, twos complement, $0 g = 0x0000$, 1 LSB = $0.25 \text{ mg} \div 2^{16}$ |

Table 123. YA_BIAS_HIGH Register Definitions

| Page | Addresses | Default | Access | Flash Backup |
|------|------------|---------|--------|--------------|
| 0x02 | 0x22, 0x23 | 0x0000 | R/W | Yes |

Table 124. YA_BIAS_HIGH Bit Definitions

| Bits | Description |
|--------|--|
| [15:0] | Y-axis accelerometer offset correction, high word, twos complement, $0 g = 0x0000$, 1 LSB = 0.25 mg |

Accelerometer Bias Adjustment, ZA_BIAS_LOW, ZA_BIAS_HIGH

The ZA_BIAS_LOW (see Table 125 and Table 126) and ZA_BIAS_HIGH (see Table 127 and Table 128) registers combine to allow users to adjust the bias of the z-axis accelerometers. The digital format examples in Table 51 also apply to the ZA_BIAS_HIGH register and the digital format examples in Table 52 apply to the number that comes from combining the ZA_BIAS_LOW and ZA_BIAS_HIGH registers. These registers influence the z-axis accelerometer measurements in the same manner that the XA_BIAS_LOW and XA_BIAS_HIGH registers influence the x-axis accelerometer measurements (see Figure 42).

Table 125. ZA_BIAS_LOW Register Definitions

| Page | Addresses | Default | Access | Flash Backup |
|------|------------|---------|--------|--------------|
| 0x02 | 0x24, 0x25 | 0x0000 | R/W | Yes |

Table 126. ZA_BIAS_LOW Bit Definitions

| Bits | Description |
|--------|---|
| [15:0] | Z-axis accelerometer offset correction, low word, twos complement, $0 g = 0x0000$, 1 LSB = $0.25 \text{ mg} \div 2^{16}$ |

Table 127. ZA_BIAS_HIGH Register Definitions

| Page | Addresses | Default | Access | Flash Backup |
|------|------------|---------|--------|--------------|
| 0x02 | 0x26, 0x27 | 0x0000 | R/W | Yes |

Table 128. ZA_BIAS_HIGH Bit Definitions

| Bits | Description |
|--------|--|
| [15:0] | Z-axis accelerometer offset correction, high word, twos complement, $0 g = 0x0000$, 1 LSB = 0.25 mg |

SCRATCH REGISTERS, USER_SCR_X

The USER_SCR_1 (see Table 129 and Table 130), USER_SCR_2 (see Table 131 and Table 132), USER_SCR_3 (see Table 133 and Table 134), and USER_SCR_4 (see Table 135 and Table 136) registers provide four locations for the user to store information.

Table 129. USER_SCR_1 Register Definitions

| Page | Addresses | Default | Access | Flash Backup |
|------|------------|---------|--------|--------------|
| 0x02 | 0x74, 0x75 | 0x0000 | R/W | Yes |

Table 130. USER_SCR_1 Bit Definitions

| Bits | Description |
|--------|--------------|
| [15:0] | User defined |

Table 131. USER_SCR_2 Register Definitions

| Page | Addresses | Default | Access | Flash Backup |
|------|------------|---------|--------|--------------|
| 0x02 | 0x76, 0x77 | 0x0000 | R/W | Yes |

Table 132. USER_SCR_2 Bit Definitions

| Bits | Description |
|--------|--------------|
| [15:0] | User defined |

Table 133. USER_SCR_3 Register Definitions

| Page | Addresses | Default | Access | Flash Backup |
|------|------------|---------|--------|--------------|
| 0x02 | 0x78, 0x79 | 0x0000 | R/W | Yes |

Table 134. USER_SCR_3 Bit Definitions

| Bits | Description |
|--------|--------------|
| [15:0] | User defined |

Table 135. USER_SCR_4 Register Definitions

| Page | Addresses | Default | Access | Flash Backup |
|------|------------|---------|--------|--------------|
| 0x02 | 0x7A, 0x7B | 0x0000 | R/W | Yes |

Table 136. USER_SCR_4 Bit Definitions

| Bits | Description |
|--------|--------------|
| [15:0] | User defined |

FLASH MEMORY ENDURANCE COUNTER, FLSHCNT_LOW, FLSHCNT_HIGH

The FLSHCNT_LOW (see Table 137 and Table 138) and FLSHCNT_HIGH (see Table 139 and Table 140) registers combine to provide a 32-bit, binary counter that tracks the number of flash memory write cycles. In addition to the number of write cycles, the flash memory has a finite service lifetime, which depends on the junction temperature. Figure 43 provides guidance for estimating the retention life for the flash memory at specific junction temperatures. The junction temperature is approximately 7°C above the case temperature.

Table 137. FLSHCNT_LOW Register Definitions

| Page | Addresses | Default | Access | Flash Backup |
|------|------------|----------------|--------|--------------|
| 0x02 | 0x7C, 0x7D | Not applicable | R | Yes |

Table 138. FLSHCNT_LOW Bit Definitions

| Bits | Description |
|--------|--------------------------------------|
| [15:0] | Flash memory write counter, low word |

Table 139. FLSHCNT_HIGH Register Definitions

| Page | Addresses | Default | Access | Flash Backup |
|------|------------|----------------|--------|--------------|
| 0x02 | 0x7E, 0x7F | Not applicable | R | Yes |

Table 140. FLSHCNT_HIGH Bit Definitions

| Bits | Description |
|--------|---------------------------------------|
| [15:0] | Flash memory write counter, high word |

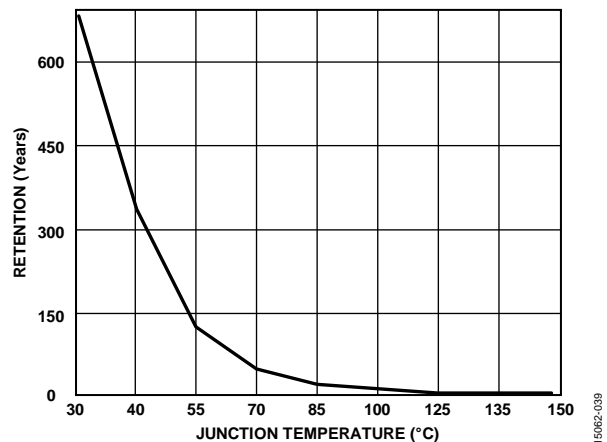

Figure 43. Flash Memory Retention

GLOBAL COMMANDS, GLOB_CMD

The GLOB_CMD register (see Table 141 and Table 142) provides trigger bits for several operations. Write a 1 to the appropriate bit in GLOB_CMD to start a particular function.

Table 141. GLOB_CMD Register Definitions

| Page | Addresses | Default | Access | Flash Backup |
|------|------------|----------------|--------|--------------|
| 0x03 | 0x02, 0x03 | Not applicable | W | No |

Table 142. GLOB_CMD Bit Definitions

| Bits | Description |
|--------|------------------------|
| [15:8] | Not used |
| 7 | Software reset |
| 6 | Clear user calibration |
| [5:4] | Not used |
| 3 | Flash memory update |
| 2 | Not used |
| 1 | Self test |
| 0 | Bias correction update |

Software Reset

Turn to Page 3 (DIN = 0x8003) and then set GLOB_CMD, Bit 7 = 1 (DIN = 0x8280, then DIN = 0x8300) to initiate a reset in the operation of the ADIS16495. This reset removes all data, initializes all registers from their flash settings, and restarts data sampling and processing. This function provides a firmware alternative to providing a low pulse on the RST pin (see Table 6, Pin 8).

Clear User Calibration

Turn to Page 3 (DIN = 0x8003) and then set GLOB_CMD, Bit 6 = 1 (DIN = 0x8240, then DIN = 0x8300) to clear all user bias/scale adjustments for each accelerometer and gyroscope. This command writes 0x0000 to the following registers: X_GYRO_SCALE, Y_GYRO_SCALE, Z_GYRO_SCALE, X_ACCL_SCALE, Y_ACCL_SCALE, Z_ACCL_SCALE, XG_BIAS_LOW, XG_BIAS_HIGH, YG_BIAS_LOW, YG_BIAS_HIGH, ZG_BIAS_LOW, ZG_BIAS_HIGH, XA_BIAS_LOW, XA_BIAS_HIGH, YA_BIAS_LOW, YA_BIAS_HIGH, ZA_BIAS_LOW, and ZA_BIAS_HIGH.

Flash Memory Update

Turn to Page 3 (DIN = 0x8003) and then set GLOB_CMD, Bit 3 = 1 (DIN = 0x8208, then DIN = 0x8300) to initiate a manual flash update. SYS_E_FLAG, Bit 6 (see Table 18) identifies success (0) or failure (1) in completing this process.

The user must not poll the status registers while waiting for the update to complete because the serial port is disabled during the update. Rather, the user must either wait the prescribed amount of time found in Table 3 or wait for the data ready indicator pin to begin toggling.

On Demand Self Test (ODST)

Turn to Page 3 (DIN = 0x8003) and then set GLOB_CMD, Bit 1 = 1 (DIN = 0x8202, then DIN = 0x8300) to run the ODST routine, which executes the following steps:

1. Measure the output on each sensor.
2. Activate an internal force on the mechanical elements of each sensor, which simulates the force associated with actual inertial motion.
3. Measure the output response on each sensor.
4. Deactivate the internal force on each sensor.
5. Calculate the difference between the force on and normal operating conditions (force off).
6. Compare the difference with internal pass/fail criteria.
7. Report the pass/fail results for each sensor in DIAG_STS (see Table 20) and the overall pass/fail flag in SYS_E_FLAG, Bit 5 (see Table 18).

False positive results are possible when the executing the ODST while the device is in motion. The user must not poll the status registers while waiting for the test to complete. Rather, the user must either wait the prescribed amount of time found in Table 3 or wait for the data ready indicator pin to begin toggling.

Bias Correction Update

Turn to Page 3 (DIN = 0x8003) and set GLOB_CMD, Bit 0 = 1 (DIN = 0x8201, then DIN = 0x8300) to update the user offset registers with the correction factors of the continuous bias estimation (CBE) (see Table 152). Ensure that the inertial platform is stable during the entire average time for optimal bias estimates.

AUXILIARY I/O LINE CONFIGURATION, FNCTIO_CTRL

The FNCTIO_CTRL register (see Table 143 and Table 144) provides configuration control for each I/O pin (DIO1, DIO2, DIO3, and DIO4). Each DIOx pin supports only one function at a time. When a single pin has two assignments, the enable bit for the lower priority function automatically resets to zero (disabling the lower priority function). The order of priority is as follows, from highest priority to lowest priority: data ready, sync clock input, and general-purpose. The ADIS16495 can take up to 20 ms to execute a write command to the FNCTIO_CTRL register. During this time, the operational state and the contents of the register remain unchanged, but the SPI interface supports normal communication (for accessing other registers).

Table 143. FNCTIO_CTRL Register Definitions

| Page | Addresses | Default | Access | Flash Backup |
|------|------------|---------|--------|--------------|
| 0x03 | 0x06, 0x07 | 0x000D | R/W | Yes |

Table 144. FNCTIO_CTRL Bit Definitions

| Bits | Description |
|--------|---|
| [15:9] | Not used |
| 8 | Sync clock mode: 1 = PPS 0 = sync |
| 7 | Sync clock input enable 1 = enabled 0 = disabled |
| 6 | Sync clock input polarity 1 = rising edge 0 = falling edge |
| [5:4] | Sync clock input line selection 00 = DIO1 01 = DIO2 10 = DIO3 11 = DIO4 |
| 3 | Data ready enable 1 = enabled 0 = disabled |
| 2 | Data ready polarity 1 = positive 0 = negative |
| [1:0] | Data ready line selection 00 = DIO1 01 = DIO2 10 = DIO3 11 = DIO4 |

Data Ready Indicator

The FNCTIO_CTRL, Bits[3:0] provide three configuration options for the data ready function: on/off, polarity, and DIOx line. The primary purpose this signal is to drive the interrupt control line of an embedded processor, which can synchronize data collection and minimize latency. The data ready indicator is useful to determine if the controller inside the ADIS16495 is busy with a task (for example, a flash memory update) because data ready stops toggling while these tasks are performed and resumes upon completion. The factory default assigns DIO2 as a positive polarity, data ready signal, which means the data in the output registers is valid when the DIO2 line is high (see Figure 25). This configuration works well when DIO2 drives an interrupt service pin that activates on a low to high pulse.

Use the following sequence to change this assignment to DIO3 with negative polarity:

1. Turn to Page 3 (DIN = 0x8003).
2. Set FNCTIO_CTRL, Bits[3:0] = 1000 (DIN = 0x860A, then DIN = 0x8700).

The timing jitter on the data ready signal is typically within ±1.4 μs. When using DIO1 to support the data ready function, this signal can experience some premature pulses, which do not indicate the start of data production, during its start-up process. If it is necessary to use DIO1 for this function, use it in conjunction with a delay or other control mechanism to prevent premature data acquisition activity during the start-up process.

Input Sync/Clock Control

The FNCTIO_CTRL, Bits[8:4] provide several configuration options for using one of the DIOx lines as an external clock signal and for controlling inertial sensor data collection and processing. For example, use the following sequence to establish DIO4 as a positive polarity, input clock pin that operates in sync mode and preserves the factory default setting for the data ready function:

1. Turn to Page 3 (DIN = 0x8003).
2. Set FNCTIO_CTRL, Bits[7:0] = 0xFD (DIN = 0x86FD).
3. Set FNCTIO_CTRL, Bits[15:8] = 0x00 (DIN = 0x8700).

In sync mode, the ADIS16495 disables its internal sample clock, and the frequency of the external clock signal establishes the rate of data collection and processing (f_{SM} in Figure 18 and Figure 19). When using the PPS mode (FNCTIO_CTRL, Bit 8 = 1), the rate of data collection and production (f_{SM}) is equal to the product of the external clock frequency and scale factor (K_{ECSF}) in the SYNC_SCALE register (see Table 154).

GENERAL-PURPOSE I/O CONTROL, GPIO_CTRL

When FNCTIO_CTRL does not configure a DIOx pin, the GPIO_CTRL register (see Table 145 and Table 146) provides user controls for general-purpose use of the DIOx pins. GPIO_CTRL, Bits[3:0] provide I/O assignment controls for each line. When the DIOx lines are inputs, monitor their level by reading GPIO_CTRL, Bits[7:4]. When the DIOx lines are used as outputs, set their level by writing to GPIO_CTRL, Bits[7:4].

For example, use the following sequence to set DIO1 and DIO3 as high and low output lines, respectively, and set DIO2 and DIO4 as input lines:

1. Turn to Page 3 (DIN = 0x8003).
2. Set GPIO_CTRL, Bits[7:0] = 0x15 (DIN = 0x8815, then DIN = 0x8900).

Table 145. GPIO_CTRL Register Definitions¹

| Page | Addresses | Default | Access | Flash Backup |
|------|------------|---------|--------|--------------|
| 0x03 | 0x08, 0x09 | 0x00X0 | R/W | Yes |

¹ GPIO_CTRL, Bits[7:4] reflect the logic levels on the DIOx lines and do not have a default setting.

Table 146. GPIO_CTRL Bit Definitions¹

| Bits | Description |
|--------|---|
| [15:8] | Don't care |
| 7 | General-Purpose I/O Line 4 (DIO4) data level |
| 6 | General-Purpose I/O Line 3 (DIO3) data level |
| 5 | General-Purpose I/O Line 2 (DIO2) data level |
| 4 | General-Purpose I/O Line 1 (DIO1) data level |
| 3 | General-Purpose I/O Line 4 (DIO4) direction control (1 = output, 0 = input) |
| 2 | General-Purpose I/O Line 3 (DIO3) direction control (1 = output, 0 = input) |
| 1 | General-Purpose I/O Line 2 (DIO2) direction control (1 = output, 0 = input) |
| 0 | General-Purpose I/O Line 1 (DIO1) direction control (1 = output, 0 = input) |

¹ GPIO_CTRL, Bits[7:4] reflect the logic levels on the DIOx lines and do not have a default setting.

MISCELLANEOUS CONFIGURATION, CONFIG

The CONFIG register (see Table 147 and Table 148) provides configuration options for the linear g compensation in the gyroscopes (on/off) and the point of percussion alignment for the accelerometers (on/off).

Table 147. CONFIG Register Definitions

| Page | Addresses | Default | Access | Flash Backup |
|------|------------|---------|--------|--------------|
| 0x03 | 0x0A, 0x0B | 0x00C0 | R/W | Yes |

Table 148. CONFIG Bit Definitions

| Bits | Description |
|--------|--|
| [15:8] | Not used |
| 7 | Linear g compensation for gyroscopes (1 = enabled) |
| 6 | Point of percussion alignment (1 = enabled) |
| [5:0] | Not used |

Point of Percussion

CONFIG, Bit 6 offers a point of percussion alignment function that maps the accelerometer sensors to the corner of the package identified in Figure 44. To activate this feature, turn to

Page 3 (DIN = 0x8003), then set CONFIG, Bit 6 = 1 (DIN = 0x8A40, then DIN = 0x8B00).

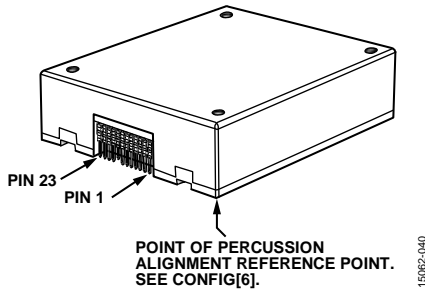

Figure 44. Point of Percussion Reference Point

LINEAR ACCELERATION ON EFFECT ON GYROSCOPE BIAS

The ADIS16495 includes first-order compensation for the linear g effect in the gyroscopes, which uses the following model:

$$\begin{bmatrix} \omega_{XC} \\ \omega_{YC} \\ \omega_{ZC} \end{bmatrix} = \begin{bmatrix} LG_{11} & LG_{12} & LG_{13} \\ LG_{21} & LG_{22} & LG_{23} \\ LG_{31} & LG_{32} & LG_{33} \end{bmatrix} \times \begin{bmatrix} A_X \\ A_Y \\ A_Z \end{bmatrix} + \begin{bmatrix} \omega_{XPC} \\ \omega_{YPC} \\ \omega_{ZPC} \end{bmatrix}$$

The linear g correction factors, LG_{XY}, apply correction for linear acceleration in all three directions to the data path of each gyroscope (ω_{XPC} , ω_{YPC} , and ω_{ZPC}) at the rate of the data samples (4250 SPS when using the internal clock). CONFIG, Bit 7 provides an on/off control for this compensation. The factory default value for this bit activates this compensation. To turn it off, turn to Page 3 (DIN = 0x8003) and set CONFIG, Bit 7 = 0 (DIN = 0x8A40, then DIN = 0x8B00). This command sequence also preserves the default setting for the point of percussion alignment function (on).

DECIMATION FILTER, DEC_RATE

The DEC_RATE register (see Table 149 and Table 150) provides user control for the final filter stage (see Figure 21), which averages and decimates the accelerometers and gyroscopes data, and extends the time that the delta angle and delta velocity track between each update. The output sample rate is equal to 4250/(DEC_RATE + 1). For example, turn to Page 3 (DIN = 0x8003), and set DEC_RATE = 0x2A (DIN = 0x8C2A, then DIN = 0x8D00) to reduce the output sample rate to ~98.8 SPS (4250 ÷ 43).

Table 149. DEC_RATE Register Definitions

| Page | Addresses | Default | Access | Flash Backup |
|------|------------|---------|--------|--------------|
| 0x03 | 0x0C, 0x0D | 0x0000 | R/W | Yes |

Table 150. DEC_RATE Bit Definitions

| Bits | Description |
|--------|--------------------------------|
| [15:0] | Decimation rate, binary format |

CONTINUOUS BIAS ESTIMATION (CBE), NULL_CNFG

The NULL_CNFG register (see Table 151 and Table 152) provides the configuration controls for the CBE, which associates with the bias correction update command in GLOB_CMD, Bit 0 (see Table 142). NULL_CNFG, Bits[3:0] establishes the total average time (t_A) for the bias estimates and NULL_CNFG, Bits[13:8] provide on/off controls for each sensor. The factory default configuration for NULL_CNFG enables the bias null command for the gyroscopes, disables the bias null command for the accelerometers, and sets the average time to ~15.42 seconds.

$$t_B = 2^{TBC}/4250 = 2^{10}/4250 = \sim 0.241 \text{ seconds}$$

$$t_A = 64 \times t_B = 64 \times 0.241 = 15.42 \text{ seconds}$$

where:

t_B is the time base.

t_A is the averaging time.

When a sensor bit in NULL_CNFG is active (equal to 1), setting GLOB_CMD, Bit 0 = 1 (DIN sequence: 0x8003, 0x8201, 0x8300) causes its bias correction register to automatically update with a value that corrects for its present bias error (from the CBE).

For example, setting NULL_CNFG, Bit 8 equal to 1 causes an update in the XG_BIAS_LOW (see Table 106) and XG_BIAS_HIGH (see Table 108) registers.

Table 151. NULL_CNFG Register Definitions

| Page | Addresses | Default | Access | Flash Backup |
|------|------------|---------|--------|--------------|
| 0x03 | 0x0E, 0x0F | 0x070A | R/W | Yes |

Table 152. NULL_CNFG Bit Definitions

| Bits | Description |
|---------|--|
| [15:14] | Not used |
| 13 | Z-axis acceleration bias correction enable (1 = enabled) |
| 12 | Y-axis acceleration bias correction enable (1 = enabled) |
| 11 | X-axis acceleration bias correction enable (1 = enabled) |
| 10 | Z-axis gyroscope bias correction enable (1 = enabled) |
| 9 | Y-axis gyroscope bias correction enable (1 = enabled) |
| 8 | X-axis gyroscope bias correction enable (1 = enabled) |
| [7:4] | Not used |
| [3:0] | Time base control (TBC), range: 0 to 13 (default = 10); $t_B = 2^{TBC}/4250$, time base; $t_A = 64 \times t_B$, average time |

SCALING THE INPUT CLOCK (PPS MODE), SYNC_SCALE

The PPS mode (FNCTIO_CTRL, Bit 8 = 1, see Table 144) supports the use of an input sync frequency that is slower than the data sample rates of the inertial sensors. This mode supports a frequency range of 1 Hz to 128 Hz for the input sync mode. In this mode, the data sample rate is equal to the product of the value in the SYNC_SCALE register (see Table 153 and Table 154) and the input sync frequency.

For example, the following command sequence sets the data collection and processing rate (f_{SM} in Figure 18 and Figure 19) to 4000 Hz (SYNC_SCALE = 0x0FA0) when using a 1 Hz signal on the DIO3 line as the external clock input, and preserves the factory default configuration for the data ready signal:

1. Turn to Page 3 (DIN = 0x8003).
2. Set SYNC_SCALE, Bits[7:0] = 0xA0 (DIN = 0x90A0).
3. Set SYNC_SCALE, Bits[15:8] = 0x0F (DIN = 0x910F).
4. Set FNCTIO_CTRL, Bits[7:0] = 0xFD (DIN = 0x86ED).
5. Set FNCTIO_CTRL, Bits[15:8] = 0x00 (DIN = 0x8701).

The data ready indicator pin does not begin to toggle until at least two external clock edges (with valid time period between them) are detected by the ADIS16495.

Table 153. SYNC_SCALE Register Definitions

| Page | Addresses | Default | Access | Flash Backup |
|------|------------|---------|--------|--------------|
| 0x03 | 0x10, 0x11 | 0x109A | R/W | Yes |

Table 154. SYNC_SCALE Bit Definitions

| Bits | Description |
|--------|---|
| [15:0] | External clock scale factor (K_{ECsf}), binary format |

Measurement Range Identifier, RANG_MDL

The RANG_MDL register (see Table 155 and Table 156) provides a convenient method for identifying the model (and gyroscope measurement range) of the ADIS16495.

Table 155. RANG_MDL Register Definitions¹

| Page | Addresses | Default | Access | Flash Backup |
|------|------------|---------|--------|--------------|
| 0x03 | 0x12, 0x13 | N/A | R | N/A |

¹ N/A means not applicable.

Table 156. RANG_MDL Bit Definitions

| Bits | Description |
|--------|--|
| [15:3] | Not used |
| [3:0] | 0011 = ADIS16495-1 ($\pm 125^\circ/\text{sec}$) 0111 = ADIS16495-2 ($\pm 450^\circ/\text{sec}$) 1111 = ADIS16495-3 ($\pm 2000^\circ/\text{sec}$) |

FIR FILTERS

FIR Filters Control, FILTR_BNK_0, FILTR_BNK_1

The FILTR_BNK_0 (see Table 157 and Table 158) and FILTR_BNK_1 (see Table 159 and Table 160) registers provide the configuration controls for the FIR filter bank in the signal

chain of each sensor (see Figure 21). These registers provide on/off control for the FIR bank for each inertial sensor, along with the FIR bank (A, B, C, or D) that each sensor uses.

Table 157. FILTR_BNK_0 Register Definitions

| Page | Addresses | Default | Access | Flash Backup |
|------|------------|---------|--------|--------------|
| 0x03 | 0x16, 0x17 | 0x0000 | R/W | Yes |

Table 158. FILTR_BNK_0 Bit Definitions

| Bits | Description (Default = 0x0000) |
|---------|---|
| 15 | Don't care |
| 14 | Y-axis accelerometer filter enable (1 = enabled) |
| [13:12] | Y-axis accelerometer filter bank selection 00 = Bank A 01 = Bank B 10 = Bank C 11 = Bank D |
| 11 | X-axis accelerometer filter enable (1 = enabled) |
| [10:9] | X-axis accelerometer filter bank selection: 00 = Bank A 01 = Bank B 10 = Bank C 11 = Bank D |
| 8 | Z-axis gyroscope filter enable (1 = enabled) |
| [7:6] | Z-axis gyroscope filter bank selection: 00 = Bank A 01 = Bank B 10 = Bank C 11 = Bank D |
| 5 | Y-axis gyroscope filter enable (1 = enabled) |
| [4:3] | Y-axis gyroscope filter bank selection: 00 = Bank A 01 = Bank B 10 = Bank C 11 = Bank D |
| 2 | X-axis gyroscope filter enable (1 = enabled) |
| [1:0] | X-axis gyroscope filter bank selection: 00 = Bank A 01 = Bank B 10 = Bank C 11 = Bank D |

Table 159. FILTR_BNK_1 Register Definitions

| Page | Addresses | Default | Access | Flash Backup |
|------|------------|---------|--------|--------------|
| 0x03 | 0x18, 0x19 | 0x0000 | R/W | Yes |

Table 160. FILTR_BNK_1 Bit Definitions

| Bits | Description |
|--------|---|
| [15:3] | Don't care |
| 2 | Z-axis accelerometer filter enable (1 = enabled) |
| [1:0] | Z-axis accelerometer filter bank selection: 00 = Bank A 01 = Bank B 10 = Bank C 11 = Bank D |

FIR Filter Bank Memory Maps

The ADIS16495 provides four FIR filter banks to configure and select for each individual inertial sensor using the FILTR_BNK_0 (see Table 158) and FILTR_BNK_1 (see Table 160) registers. Each FIR filter bank (A, B, C, and D) has 120 taps that consume two pages of memory. The coefficient associated with each tap, in each filter bank, has its own dedicated register that uses a 16-bit, twos complement format. The FIR filter has unity gain when the sum of all of the coefficients is equal to 32,768. For filter designs that require less than 120 taps, write 0x0000 to all unused registers to eliminate the latency associated with that particular tap.

FIR Filter Bank A, FIR_COEF_A000 to FIR_COEF_A119

Table 161. FIR Filter Bank A Memory Map

| Page | PAGE_ID | Addresses | Register |
|------|---------|--------------|-----------------------------------|
| 5 | 0x05 | 0x00, 0x01 | PAGE_ID |
| 5 | 0x05 | 0x02 to 0x07 | Not used |
| 5 | 0x05 | 0x08, 0x09 | FIR_COEF_A000 |
| 5 | 0x05 | 0x0A, 0x0B | FIR_COEF_A001 |
| 5 | 0x05 | 0x0C to 0x7D | FIR_COEF_A002 to FIR_COEF_A058 |
| 5 | 0x05 | 0x7E, 0x7F | FIR_COEF_A059 |
| 6 | 0x06 | 0x00, 0x01 | PAGE_ID |
| 6 | 0x06 | 0x02 to 0x07 | Not used |
| 6 | 0x06 | 0x08, 0x09 | FIR_COEF_A060 |
| 6 | 0x06 | 0x0A, 0x0B | FIR_COEF_A061 |
| 6 | 0x06 | 0x0C to 0x7D | FIR_COEF_A062 to FIR_COEF_A118 |
| 6 | 0x06 | 0x7E, 0x7F | FIR_COEF_A119 |

Table 162 and Table 163 provide detailed register and bit definitions for one of the FIR coefficient registers in Bank A, FIR_COEF_A071. Table 164 provides a configuration example, which sets this register to a decimal value of -169 (0xFF57).

Table 162. FIR_COEF_A071 Register Definitions

| Page | Addresses | Default | Access | Flash Backup |
|------|------------|----------------|--------|--------------|
| 0x06 | 0x1E, 0x1F | Not applicable | R/W | Yes |

Table 163. FIR_COEF_A071 Bit Definitions

| Bits | Description |
|--------|---|
| [15:0] | FIR Bank A, Coefficient 71, twos complement |

Table 164. Configuration Example, FIR Coefficient

| DIN Command | Description |
|-------------|----------------------------------|
| 0x8006 | Turn to Page 6 |
| 0x9E57 | FIR_COEF_A071, Bits[7:0] = 0x57 |
| 0x9FFF | FIR_COEF_A071, Bits[15:8] = 0xFF |

FIR Filter Bank B, FIR_COEF_B000 to FIR_COEF_B119

Table 165. Filter Bank B Memory Map

| Page | PAGE_ID | Addresses | Register |
|------|---------|--------------|-----------------------------------|
| 7 | 0x07 | 0x00, 0x01 | PAGE_ID |
| 7 | 0x07 | 0x02 to 0x07 | Not used |
| 7 | 0x07 | 0x08, 0x09 | FIR_COEF_B000 |
| 7 | 0x07 | 0x0A, 0x0B | FIR_COEF_B001 |
| 7 | 0x07 | 0x0C to 0x7D | FIR_COEF_B002 to FIR_COEF_B058 |
| 7 | 0x07 | 0x7E, 0x7F | FIR_COEF_B059 |
| 8 | 0x08 | 0x00, 0x01 | PAGE_ID |
| 8 | 0x08 | 0x02 to 0x07 | Not used |
| 8 | 0x08 | 0x08, 0x09 | FIR_COEF_B060 |
| 8 | 0x08 | 0x0A, 0x0B | FIR_COEF_B061 |
| 8 | 0x08 | 0x0C to 0x7D | FIR_COEF_B062 to FIR_COEF_B118 |
| 8 | 0x08 | 0x7E, 0x7F | FIR_COEF_B119 |

FIR Filter Bank C, FIR_COEF_C000 to FIR_COEF_C119

Table 166. Filter Bank C Memory Map

| Page | PAGE_ID | Addresses | Register |
|------|---------|--------------|-----------------------------------|
| 9 | 0x09 | 0x00, 0x01 | PAGE_ID |
| 9 | 0x09 | 0x02 to 0x07 | Not used |
| 9 | 0x09 | 0x08, 0x09 | FIR_COEF_C000 |
| 9 | 0x09 | 0x0A, 0x0B | FIR_COEF_C001 |
| 9 | 0x09 | 0x0C to 0x7D | FIR_COEF_C002 to FIR_COEF_C058 |
| 9 | 0x09 | 0x7E, 0x7F | FIR_COEF_C059 |
| 10 | 0x0A | 0x00, 0x01 | PAGE_ID |
| 10 | 0x0A | 0x02 to 0x07 | Not used |
| 10 | 0x0A | 0x08, 0x09 | FIR_COEF_C060 |
| 10 | 0x0A | 0x0A, 0x0B | FIR_COEF_C061 |
| 10 | 0x0A | 0x0C to 0x7D | FIR_COEF_C062 to FIR_COEF_C118 |
| 10 | 0x0A | 0x7E, 0x7F | FIR_COEF_C119 |

FIR Filter Bank D, FIR_COEF_D000 to FIR_COEF_D119

Table 167. Filter Bank D Memory Map

| Page | PAGE_ID | Addresses | Register |
|------|---------|--------------|-----------------------------------|
| 11 | 0x0B | 0x00, 0x01 | PAGE_ID |
| 11 | 0x0B | 0x02 to 0x07 | Not used |
| 11 | 0x0B | 0x08, 0x09 | FIR_COEF_D000 |
| 11 | 0x0B | 0x0A, 0x0B | FIR_COEF_D001 |
| 11 | 0x0B | 0x0C to 0x7D | FIR_COEF_D002 to FIR_COEF_D058 |
| 11 | 0x0B | 0x7E, 0x7F | FIR_COEF_D059 |
| 12 | 0x0C | 0x00, 0x01 | PAGE_ID |
| 12 | 0x0C | 0x02 to 0x07 | Not used |
| 12 | 0x0C | 0x08, 0x09 | FIR_COEF_D060 |
| 12 | 0x0C | 0x0A, 0x0B | FIR_COEF_D061 |
| 12 | 0x0C | 0x0C to 0x7D | FIR_COEF_D062 to FIR_COEF_D118 |
| 12 | 0x0C | 0x7E, 0x7F | FIR_COEF_D119 |

Default Filter Performance

The FIR filter banks have factory programmed filter designs that are all low-pass filters that have unity dc gain. Table 168 provides a summary of each filter design, and Figure 45 shows the frequency response characteristics. The phase delay is equal to 1/2 of the total number of taps.

Table 168. FIR Filter Descriptions, Default Configuration

| FIR Filter Bank | Taps | -3 dB Frequency (Hz) |
|-----------------|------|----------------------|
| A | 120 | 300 |
| B | 120 | 100 |
| C | 32 | 300 |
| D | 32 | 100 |

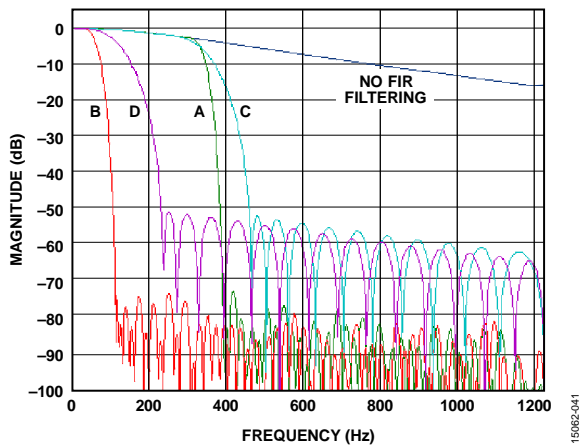

Figure 45. FIR Filter Frequency Response Curves

FIRMWARE REVISION, FIRM_REV

The FIRM_DM register (see Table 169 and Table 170) contains the month and day of the factory configuration date. FIRM_DM, Bits[15:12] and FIRM_DM, Bits[11:8] contain digits that represent the month of the factory configuration in a binary coded decimal (BCD) format. For example, November is the 11th month in a year and is represented by FIRM_DM, Bits[15:8] = 0x11. FIRM_DM, Bits[7:4], and FIRM_DM, Bits[3:0], contain digits that represent the day of factory configuration in a BCD format. For example, the 27th day of the month is represented by FIRM_DM, Bits[7:0] = 0x27.

Table 169. FIRM_REV Register Definitions

| Page | Addresses | Default | Access | Flash Backup |
|------|------------|----------------|--------|--------------|
| 0x03 | 0x78, 0x79 | Not applicable | R | Yes |

Table 170. FIRM_REV Bit Definitions

| Bits | Description |
|---------|---|
| [15:12] | Firmware revision BCD code, tens digit, numerical format = 4-bit binary, range = 0 to 9 |
| [11:8] | Firmware revision BCD code, ones digit, numerical format = 4-bit binary, range = 0 to 9 |
| [7:4] | Firmware revision BCD code, tenths digit, numerical format = 4-bit binary, range = 0 to 9 |
| [3:0] | Firmware revision BCD code, hundredths digit, numerical format = 4-bit binary, range = 0 to 9 |

Table 171. FIRM_DM Register Definitions

| Page | Addresses | Default | Access | Flash Backup |
|------|------------|----------------|--------|--------------|
| 0x03 | 0x7A, 0x7B | Not applicable | R | Yes |

Table 172. FIRM_DM Bit Definitions

| Bits | Description |
|---------|---|
| [15:12] | Factory configuration month BCD code, tens digit, numerical format = 4-bit binary, range = 0 to 2 |
| [11:8] | Factory configuration month BCD code, ones digit, numerical format = 4-bit binary, range = 0 to 9 |
| [7:4] | Factory configuration day BCD code, tens digit, numerical format = 4-bit binary, range = 0 to 3 |
| [3:0] | Factory configuration day BCD code, ones digit, numerical format = 4-bit binary, range = 0 to 9 |

Firmware Revision Year, FIRM_Y

The FIRM_Y register (see Table 173 and Table 174) contains the year of the factory configuration date. For example, the year 2013 is represented by FIRM_Y = 0x2013.

Table 173. FIRM_Y Register Definitions

| Page | Addresses | Default | Access | Flash Backup |
|------|------------|----------------|--------|--------------|
| 0x03 | 0x7C, 0x7D | Not applicable | R | Yes |

Table 174. FIRM_Y Bit Definitions

| Bits | Description |
|---------|---|
| [15:12] | Factory configuration year BCD code, thousands digit, numerical format = 4-bit binary, range = 0 to 9 |
| [11:8] | Factory configuration year BCD code, hundreds digit, numerical format = 4-bit binary, range = 0 to 9 |
| [7:4] | Factory configuration year BCD code, tens digit, numerical format = 4-bit binary, range = 0 to 3 |
| [3:0] | Factory configuration year BCD code, ones digit, numerical format = 4-bit binary, range = 0 to 9 |

Boot Revision Number, BOOT_REV

The BOOT_REV register (see Table 175 and Table 176) contains the revision of the boot code in the ADIS16495 processor core.

Table 175. BOOT_REV Register Definitions

| Page | Addresses | Default | Access | Flash Backup |
|------|------------|----------------|--------|--------------|
| 0x03 | 0x7E, 0x7F | Not applicable | R | Yes |

Table 176. BOOT_REV Bit Definitions

| Bits | Description |
|--------|-------------------------------|
| [15:8] | Binary, major revision number |
| [7:0] | Binary, minor revision number |

Continuous SRAM Testing

This device employs a CRC function on the SRAM memory blocks that contain the program code (CODE_SIGTR_XXX) and the calibration coefficients (CAL_DRVTN_XXX). This process operates in the background and generates real-time, 32-bit CRC values for the program code and calibration coefficients, respectively. At the conclusion of each cycle, the processor writes these calculated

values in the CAL_DRVTN_xxx and CODE_DRVTN_xxx registers (see Table 182, Table 184, Table 190, and Table 192) and compares them with the signature values, which reflect the state of these memory locations at the time of factory configuration. When the calculation results do not match the signature values, SYS_E_FLAG, Bit 2 increases to a 1. The respective signature values are available for user access through the CAL_SIGTR_xxx and CODE_SIGTR_xxx registers (see Table 178, Table 180, Table 186, and Table 188). The following conditions must be met for SYS_E_FLAG, Bit 2 to remain at the zero level:

- CAL_SIGTR_LWR = CAL_DRVTN_LWR
- CAL_SIGTR_UPR = CAL_DRVTN_UPR
- CODE_SIGTR_LWR = CODE_DRVTN_LWR
- CODE_SIGTR_UPR = CODE_DRVTN_UPR

Signature CRC, Calibration Values, CAL_SIGTR_LWR

Table 177. CAL_SIGTR_LWR Register Definitions

| Page | Addresses | Default | Access | Flash Backup |
|------|------------|----------------|--------|--------------|
| 0x04 | 0x04, 0x05 | Not applicable | R | Yes |

Table 178. CAL_SIGTR_LWR Bit Definitions

| Bits | Description |
|--------|---|
| [15:0] | Factory programmed CRC value for the program code, low word |

Signature CRC, Calibration Values, CAL_SIGTR_UPR

Table 179. CAL_SIGTR_UPR Register Definitions

| Page | Addresses | Default | Access | Flash Backup |
|------|------------|----------------|--------|--------------|
| 0x04 | 0x06, 0x07 | Not applicable | R | Yes |

Table 180. CAL_SIGTR_UPR Bit Definitions

| Bits | Description |
|--------|--|
| [15:0] | Factory programmed CRC value for the program code, high word |

Derived CRC, Calibration Values, CAL_DRVTN_LWR

Table 181. CAL_DRVTN_LWR Register Definitions

| Page | Addresses | Default | Access | Flash Backup |
|------|------------|----------------|--------|--------------|
| 0x04 | 0x08, 0x09 | Not applicable | R | No |

Table 182. CAL_DRVTN_LWR Bit Definitions

| Bits | Description |
|--------|---|
| [15:0] | Calculated CRC value for the program code, low word |

Derived CRC, Calibration Values, CAL_DRVTN_UPR

Table 183. CAL_DRVTN_UPR Register Definitions

| Page | Addresses | Default | Access | Flash Backup |
|------|------------|----------------|--------|--------------|
| 0x04 | 0x0A, 0x0B | Not applicable | R | No |

Table 184. CAL_DRVTN_UPR Bit Definitions

| Bits | Description |
|--------|--|
| [15:0] | Calculated CRC value for the program code, high word |

Signature CRC, Program Code, CODE_SIGTR_LWR

Table 185. CODE_SIGTR_LWR Register Definitions

| Page | Addresses | Default | Access | Flash Backup |
|------|------------|----------------|--------|--------------|
| 0x04 | 0x0C, 0x0D | Not applicable | R | Yes |

Table 186. CODE_SIGTR_LWR Bit Definitions

| Bits | Description |
|--------|---|
| [15:0] | Factory programmed CRC value for the calibration coefficients, low word |

Signature CRC, Program Code, CODE_SIGTR_UPR

Table 187. CODE_SIGTR_UPR Register Definitions

| Page | Addresses | Default | Access | Flash Backup |
|------|------------|----------------|--------|--------------|
| 0x04 | 0x0E, 0x0F | Not applicable | R | Yes |

Table 188. CODE_SIGTR_UPR Bit Definitions

| Bits | Description |
|--------|--|
| [15:0] | Factory programmed CRC value for the calibration coefficients, high word |

Derived CRC, Program Code, CODE_DRVTN_LWR

Table 189. CODE_DRVTN_LWR Register Definitions

| Page | Addresses | Default | Access | Flash Backup |
|------|------------|----------------|--------|--------------|
| 0x04 | 0x10, 0x11 | Not applicable | R | No |

Table 190. CODE_DRVTN_LWR Bit Definitions

| Bits | Description |
|--------|---|
| [15:0] | Calculated CRC value for the calibration coefficients, low word |

Derived CRC, Program Code, CODE_DRVTN_UPR

Table 191. CODE_DRVTN_UPR Register Definitions

| Page | Addresses | Default | Access | Flash Backup |
|------|------------|----------------|--------|--------------|
| 0x04 | 0x12, 0x13 | Not applicable | R | No |

Table 192. CODE_DRVTN_UPR Bit Definitions

| Bits | Description |
|--------|--|
| [15:0] | Calculated CRC value for the calibration coefficients, high word |

Lot Specific Serial Number, SERIAL_NUM

Table 193. SERIAL_NUM Register Definitions

| Page | Addresses | Default | Access | Flash Backup |
|------|------------|----------------|--------|--------------|
| 0x04 | 0x20, 0x21 | Not applicable | R | Yes |

Table 194. SERIAL_NUM Bit Definitions

| Bits | Description |
|--------|----------------------------|
| [15:0] | Lot specific serial number |

APPLICATIONS INFORMATION

MOUNTING BEST PRACTICES

For the best performance, follow these guidelines when installing the ADIS16495 into a system:

- Eliminate opportunity for translational force (x- and y-axis direction, per Figure 35) application on the electrical connector.
- Use uniform mounting forces on all four corners. The suggested torque setting is 40 inch ounces (0.285 Nm).
- When the ADIS16495 rests on the PCB, which contains the mating connector (see Figure 46), use a diameter of at least 2.85 mm for the passthrough holes.

These guidelines help prevent irregular force profiles, which can warp the package and introduce bias errors in the sensors. Figure 46 and Figure 47 provide details for mounting hole and connector alignment pin drill locations.

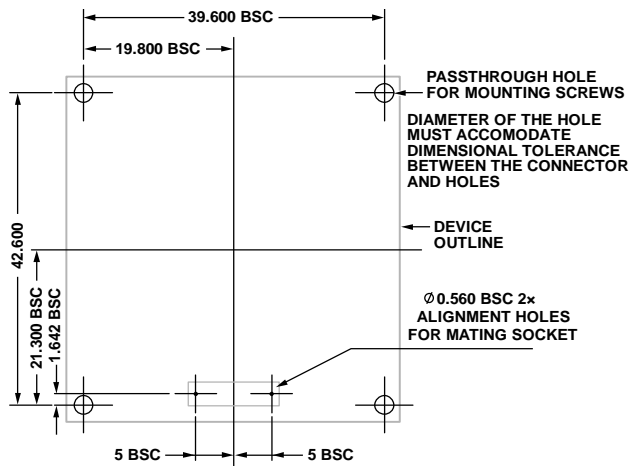

NOTES
 1. ALL DIMENSIONS IN UNITS OF MILLIMETERS (mm).
 2. IN THIS CONFIGURATION, THE CONNECTOR IS FACING DOWN AND ITS PINS ARE NOT VISIBLE.

Figure 46. Suggested PCB Layout Pattern, Connector Down

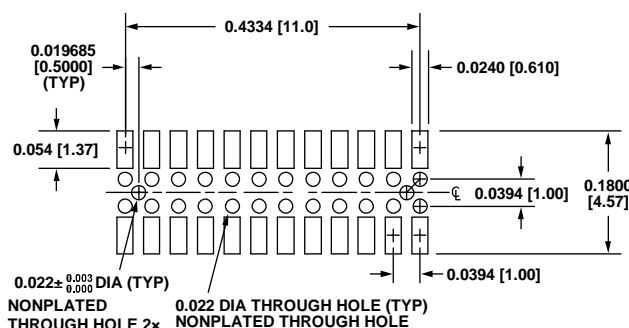

Figure 47. Suggested Layout and Mechanical Design when Using Samtec CLM-112-02-G-D-A for the Mating Connector

PREVENTING MISINSERTION

The ADIS16495 connector uses the same pattern as the ADIS16485, but with Pin 12 and Pin 15 missing. This pin configuration enables a mating connector to plug these holes, which helps prevent misconnection of the ADIS16495. Samtec has a custom part number that provides this type of mating socket: ASP-193371-04.

EVALUATION TOOLS

Breakout Board, ADIS16IMU1/PCBZ

The ADIS16IMU1/PCBZ (sold separately) provides a breakout board function for the ADIS16495, which means that it provides access to the ADIS16495 through larger connectors that support standard 1 mm ribbon cabling. It also provides four mounting holes for attachment of the ADIS16495 to the breakout board.

PC-Based Evaluation, EVAL-ADIS2

Use the EVAL-ADIS2 and ADIS16IMU1/PCBZ to evaluate the ADIS16495 on a PC-based platform.

POWER SUPPLY CONSIDERATIONS

The VDD power supply must charge 46 μF of capacitance (inside of the ADIS16495, across the VDD and GND pins) during its initial ramp and settling process. When VDD reaches 2.85 V, the ADIS16495 begins its internal start-up process, which generates additional transient current demand. See Figure 48 for a typical current profile during the start-up process. The first peak in Figure 48 relates to charging the 46 μF capacitor bank, whereas the other transient activity relates to numerous functions turning on during the initialization process of the ADIS16495.

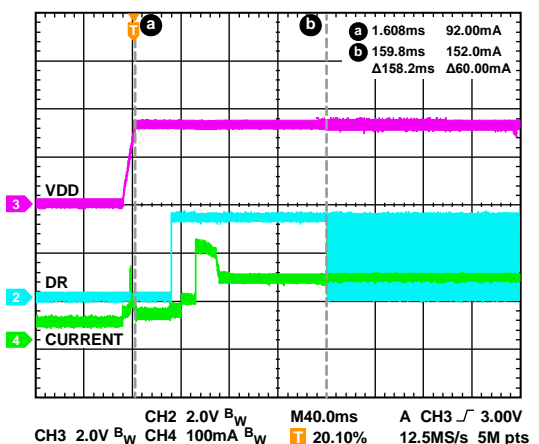

Figure 48. Transient Current Demand, Startup (DR Means Data Ready)

CRC32 CODING EXAMPLE

This section contains sample code and values for computing the cyclic redundancy check (CRC) for the ADIS16495 register readback values.

In this coding example, the 32-bit CRC is first initialized with 0xFFFFFFFF. Next, each 16-bit word passes through the CRC computation in ascending order. Finally, the CRC is XOR'ed with 0xFFFFFFFF.

The ADIS16495 updates the CRC value for each data ready cycle. The registers listed in Table 195 are used as inputs for computing the CRC32 checksum. The registers can either be read individually in normal SPI mode or in burst mode, provided that all registers are all read during the same data ready cycle.

Table 195. Sample Input Data for CRC Computation¹

| Register Number | Register | Input Value |
|-----------------|------------|-------------|
| 1 | STATUS | 0x0000 |
| 2 | TEMP_OUT | 0x083A |
| 3 | X_GYRO_LOW | 0x0000 |
| 4 | X_GYRO_OUT | 0xFFFF7 |
| 5 | Y_GYRO_LOW | 0x0000 |
| 6 | Y_GYRO_OUT | 0xFFFE |
| 7 | Z_GYRO_LOW | 0x0000 |
| 8 | Z_GYRO_OUT | 0x0001 |
| 9 | X_ACCL_LOW | 0x5001 |
| 10 | X_ACCL_OUT | 0x0003 |
| 11 | Y_ACCL_LOW | 0xE00A |
| 12 | Y_ACCL_OUT | 0x0015 |
| 13 | Z_ACCL_LOW | 0xC009 |
| 14 | Z_ACCL_OUT | 0x0320 |
| 15 | TIME_STAMP | 0x8A54 |

¹This information is contained in the array data in the coding example.

Table 196. Output Results for CRC Sample Computation¹

| Register Number | Register | Output Value |
|-----------------|----------|--------------|
| 1 | CRC_LWR | 0x15B4 |
| 2 | CRC_UPR | 0xB6C8 |

¹Based on the input shown in Table 195.

The following is the CRC initialization code:

```
/* Initialize CRC */
crc = 0xFFFFFFFFFU;
/* Compute CRC in the order of bytes low-high
starting at 0-14, BurstID, STATUS - TIME_STAMP */
crc = crc32_block(crc, DATA, 15);
/* Final operation per IEEE-802.3 */
crc ^= 0xFFFFFFFFFU;
```

The `crc32_block` function accepts an array of 16-bit numbers and computes the CRC byte-by-byte:

```
unsigned long crc32_block( unsigned long crc,
const unsigned short data[], int n )
{
    unsigned long long_c;
    int i;

    /* cycle through memory */
    for ( i=0; i<n; i++ )
    {
        /* Get lower byte */
        long_c = 0x000000ff &
(unsigned long)data[i];
        /* Process with CRC */
        crc = ((crc>>8) & 0x00ffffff) ^
crc_tab32[(crc^long_c)&0xff];
        /* Get upper byte */
        long_c = (0x000000ff &
((unsigned long)data[i]>>8));
        /* Process with CRC */
        crc = ((crc>>8) & 0x00ffffff) ^
crc_tab32[(crc^long_c)&0xff];
    }
    return crc;
}
```

The CRC table (`crc_tab32`) is computed with the following function:

```
void init_crc32_table( void )
{
    unsigned long P_32;
    int i, j;
    unsigned long crc;

    /* CRC32 polynomial defined by IEEE-802.3 */
    P_32 = 0xEDB88320

    /* 8 bits require 256 entries in Table */
    for (i=0; i<256; i++)
    {
        /* start with table entry number */
        crc = (unsigned long) i;

        /* cycle through all bits in entry number */
        for (j=0; j<8; j++)
        {
            /* LSBit set? */
            if ((crc&(unsigned
long)0x00000001)!=((unsigned long)0)
            {
                /* process for bit set */
                crc = (crc>>1) ^ P_32;
            }
            else
            {
                /* process for bit clear */
                crc = (crc>>1);
            }
        }
        /* Store calculated value into table */
        crc_tab32[i] = crc;
    }
}
```