

## FEATURES

- Transmit VGA for RF DAC, transceiver, and SoC to power amplifier interface**
- RF output frequency range: 1500 MHz to 3000 MHz**
- Internal balun with bias-tee to supply RF DAC outputs**
- Integrated VVA attenuation range with on-chip DAC: 20.5 dB**
- 2-stage high linearity amplifiers**
- RF DSA attenuation range: 15.5 dB with 0.5 dB step resolution**
- 50  $\Omega$  differential inputs and 50  $\Omega$  single-ended output**
- Fully programmable via a 4-wire SPI**
- Single 5 V supply**
- 38-terminal, 10.5 mm  $\times$  5.5 mm LGA**

## APPLICATIONS

- 2G/3G/4G/long-term evolution (LTE) in FDD/TDD broadband communication systems**

## GENERAL DESCRIPTION

The ADL6317 is a transmit variable gain amplifier (VGA) that provides an interface from radio frequency digital-to-analog converters (RF DACs), transceivers, and systems on a chip (SoC) to power amplifiers. Integrated balun and hybrid couplers allow high performance RF capability in the frequency range of 1500 MHz to 3000 MHz.

To optimize performance vs. power level, the ADL6317 includes a voltage variable attenuator (VVA), high linearity amplifiers, and a digital step attenuator (DSA). All of the devices integrated into the ADL6317 are programmable via a 4-wire serial port interface (SPI).

The ADL6317 is manufactured on an advanced silicon germanium (SiGe), bipolar complementary metal oxide semiconductor (BiCMOS) process.

Table 1. Related Devices in Transmit VGA Family

| Parameter | Frequency Range (MHz) |
|-----------|-----------------------|
| ADL6316   | 500 to 1000           |
| ADL6317   | 1500 to 3000          |

## FUNCTIONAL BLOCK DIAGRAM

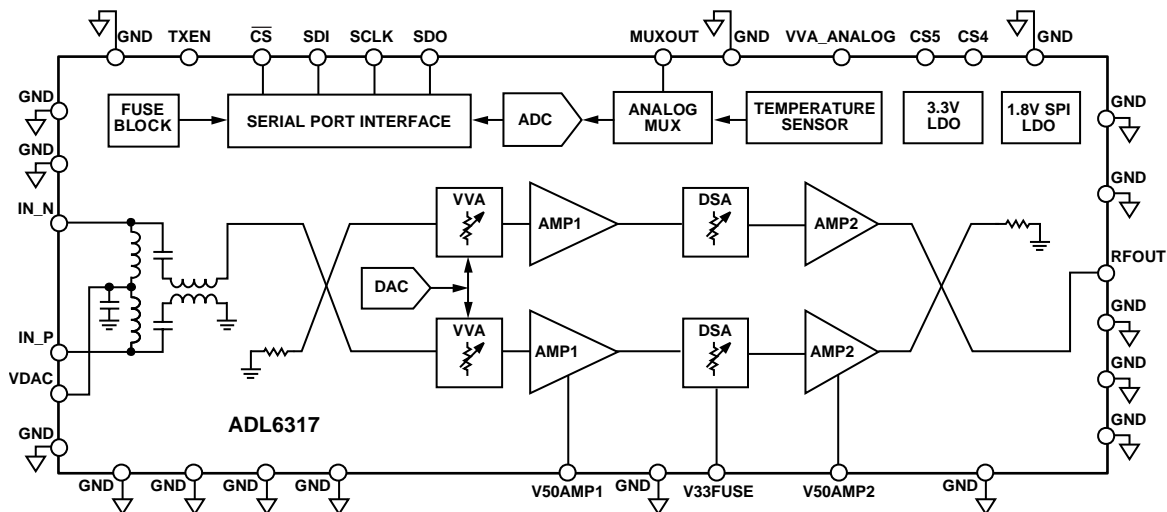

Figure 1.

20029-001

## TABLE OF CONTENTS

|   |    |  |    |
|---|----|--|----|
| Features .....                                    | 1  | Programmability Guide.....                         | 16 |
| Applications .....                                | 1  | Signal Path Modes.....                             | 16 |
| General Description .....                         | 1  | Auxiliary Mux Control.....                         | 16 |
| Functional Block Diagram .....                    | 1  | Serial Port Interface (SPI) .....                  | 18 |
| Revision History .....                            | 2  | Device Setup.....                                  | 19 |
| Specifications .....                              | 3  | Applications Information .....                     | 21 |
| Digital Logic Timing.....                         | 4  | Linearity Optimization.....                        | 21 |
| Absolute Maximum Ratings .....                    | 6  | Performance and Power Optimization .....           | 21 |
| Thermal Resistance .....                          | 6  | Adjacent and Alternate Channel Power Ratios on LTE |    |
| ESD Caution.....                                  | 6  | Operation .....                                    | 21 |
| Pin Configuration and Function Descriptions ..... | 7  | Layout .....                                       | 22 |
| Typical Performance Characteristics.....          | 8  | Characterization Setups.....                       | 23 |
| Theory of Operation .....                         | 14 | Register Summary .....                             | 24 |
| RF Input Balun with DAC Interface Network .....   | 14 | Register Details .....                             | 25 |
| Quadrature Hybrid .....                           | 14 | Outline Dimensions.....                            | 38 |
| RF Signal Chain .....                             | 14 | Ordering Guide .....                               | 38 |
| Basic Connections .....                           | 15 |  |    |

## REVISION HISTORY

5/2020—Revision B: Initial Version

## SPECIFICATIONS

$V_{50AMP1} = V_{50AMP2} = 5\text{ V}$ ,  $T_A = 25^\circ\text{C}$ , input power ( $P_{IN}$ ) =  $-25\text{ dBm}$  ( $-25\text{ dBm}$  per tone for two tones), VVA attenuation =  $0\text{ dB}$ , DSA attenuation =  $0\text{ dB}$ , source resistance ( $R_S$ ) = load resistance ( $R_L$ ) =  $50\ \Omega$ , unless otherwise noted.

**Table 2.**

| Parameter                             | Test Conditions/Comments   | Min  | Typ       | Max  | Units         |
|---------------------------------------|--|------|-----------|------|---------------|
| FREQUENCY RANGE                       |  | 1500 |           | 3000 | MHz           |
| 1850 MHz                              |  |      |           |      |               |
| Power Gain                            |  |      | 33.7      |      | dB            |
| Output 1 dB Compression Point (OP1dB) |  |      | 25.7      |      | dBm           |
| Output Second-Order Intercept (OIP2)  |  |      | 49.2      |      | dBm           |
| Output Third-Order Intercept (OIP3)   |  |      | 40.9      |      | dBm           |
| Second Harmonic (HD2)                 |  |      | 82.1      |      | dBc           |
| Third Harmonic (HD3)                  |  |      | 47.2      |      | dBc           |
| Noise Figure (NF)                     |  |      | 6.0       |      | dB            |
| 2150 MHz                              |  |      |           |      |               |
| Power Gain                            |  |      | 33.6      |      | dB            |
| OP1dB                                 |  |      | 24.8      |      | dBm           |
| OIP2                                  |  |      | 51.8      |      | dBm           |
| OIP3                                  |  |      | 38.4      |      | dBm           |
| HD2                                   |  |      | 76.1      |      | dBc           |
| HD3                                   |  |      | 48.8      |      | dBc           |
| NF                                    |  |      | 6.0       |      | dB            |
| 2600 MHz                              |  |      |           |      |               |
| Power Gain                            |  |      | 34.0      |      | dB            |
| OP1dB                                 |  |      | 22.8      |      | dBm           |
| OIP2                                  |  |      | 53.8      |      | dBm           |
| OIP3                                  |  |      | 34.5      |      | dBm           |
| HD2                                   |  |      | 84.6      |      | dBc           |
| HD3                                   |  |      | 50.7      |      | dBc           |
| NF                                    |  |      | 5.5       |      | dB            |
| RF INPUT/OUTPUT CHARACTERISTICS       |  |      |           |      |               |
| Input                                 |  |      |           |      |               |
| Impedance                             | Differential   |      | 50        |      | $\Omega$      |
| Return Loss                           | Inband, 2150 MHz   |      | -18       |      | dB            |
| Output                                |  |      |           |      |               |
| Impedance                             | Single-ended   |      | 50        |      | $\Omega$      |
| Return Loss                           | Inband, 2150 MHz   |      | -17.4     |      | dB            |
| Gain Flatness                         | Deviation from best linear fit at 1850 MHz, 2150 MHz, and 2600 MHz     |      |           |      |               |
|                                       | Over $\pm 100\text{ MHz}$ bandwidth                                    |      | $\pm 0.1$ |      | dB            |
|                                       | Over $\pm 150\text{ MHz}$ bandwidth                                    |      | $\pm 0.2$ |      | dB            |
| VOLTAGE VARIABLE ATTENUATOR           | Via 12-bit integrated DAC or external analog voltage on VVA_ANALOG pin |      |           |      |               |
| Range                                 |  |      | 20.5      |      | dB            |
| Gain Settling Time                    | Minimum attenuation to maximum attenuation by VVA DAC                  |      | 386.8     |      | ns            |
|                                       | Maximum attenuation to minimum attenuation by VVA DAC                  |      | 1.681     |      | $\mu\text{s}$ |
| DSA Attenuation                       |  |      |           |      |               |
| Range                                 |  |      | 15.5      |      | dB            |
| Resolution                            |  |      | 0.5       |      | dB            |
| Gain Settling Time                    | Minimum attenuation to maximum attenuation                             |      | 304.4     |      | ns            |
|                                       | Maximum attenuation to minimum attenuation                             |      | 195.0     |      | ns            |

| Parameter            | Test Conditions/Comments   | Min  | Typ | Max  | Units   |
|----------------------|--|------|-----|------|---------|
| <b>DIGITAL LOGIC</b> |  |      |     |      |         |
| Input Voltage        | SCLK, SDI, $\overline{CS}$ , CS4, CS5, TXEN                          |      |     |      |         |
| High ( $V_{IH}$ )    |  | 1.07 |     |      | V       |
| Low ( $V_{IL}$ )     |  |      |     | 0.68 | V       |
| Input Current        |  |      |     |      |         |
| High ( $I_{IH}$ )    |  |      |     | -100 | $\mu$ A |
| Low ( $I_{IL}$ )     |  |      |     | 100  | $\mu$ A |
| Output Voltage       | SDO  |      |     |      |         |
| At 1.8 V             | Register 0x121, Bit 4 = 0x0  |      |     |      |         |
| High ( $V_{OH}$ )    | Output high current ( $I_{OH}$ ) = -100 $\mu$ A or -1 mA static load | 1.5  |     |      | V       |
| Low ( $V_{OL}$ )     | Output low current ( $I_{OL}$ ) = 100 $\mu$ A or 1 mA static load    |      |     | 0.2  | V       |
| At 3.3 V             | Register 0x121, Bit 4 = 0x1  |      |     |      |         |
| High ( $V_{OH}$ )    | $I_{OH}$ = -100 $\mu$ A or -1 mA static load                         | 2.7  |     |      | V       |
| Low ( $V_{OL}$ )     | $I_{OL}$ = 100 $\mu$ A or 1 mA static load                           |      |     | 0.2  | V       |
| <b>POWER SUPPLY</b>  |  |      |     |      |         |
| Voltage              |  | 4.75 | 5.0 | 5.25 | V       |
| Supply Current       | High performance mode  |      | 435 |      | mA      |
|                      | Low power mode   |      | 310 |      | mA      |
| Power Down Current   |  |      | 6   |      | mA      |

**DIGITAL LOGIC TIMING**

Table 3.

| Parameter  | Description  | Min | Typ | Max | Unit |
|------------|--|-----|-----|-----|------|
| $f_{SCLK}$ | Maximum serial clock rate, $1/t_{SCLK}$  |     | 25  |     | MHz  |
| $t_{PWH}$  | Minimum period that SCLK is in logic high state  |     | 10  |     | ns   |
| $t_{PWL}$  | Minimum period that SCLK is in logic low state   |     | 10  |     | ns   |
| $t_{DS}$   | Setup time between data and rising edge of SCLK  |     | 5   |     | ns   |
| $t_{DH}$   | Hold time between data and rising edge of SCLK   |     | 5   |     | ns   |
| $t_{DCS}$  | Setup time between falling edge of $\overline{CS}$ and rising edge of SCLK                 |     | 10  |     | ns   |
| $t_{DV}$   | Maximum time delay between falling edge of SCLK and output data valid for a read operation |     | 5   |     | ns   |

**Timing Diagrams**

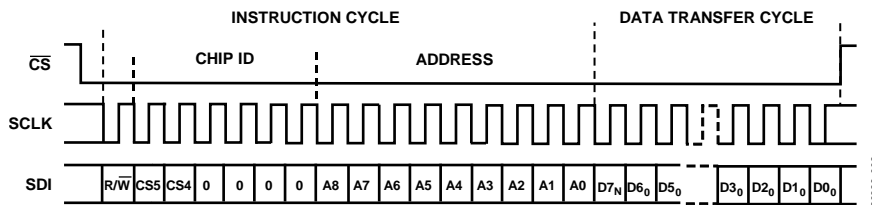

Figure 2. Serial Port Interface Register Timing, MSB First

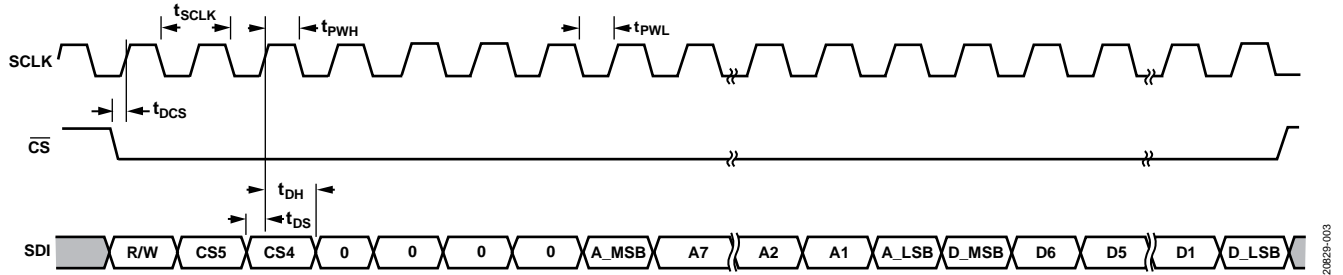

Figure 3. Timing Diagram for the Serial Port Interface Register Write

20829-003

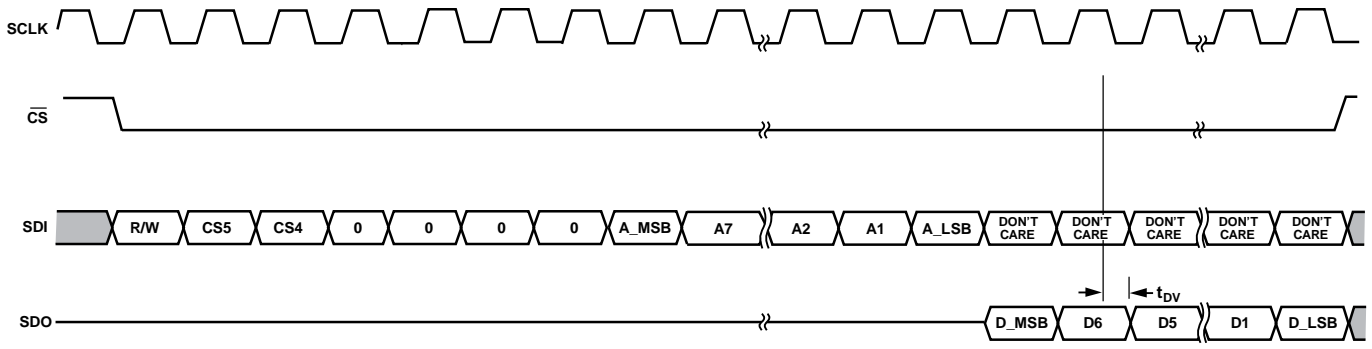

Figure 4. Timing Diagram for Serial Port Interface Register Read

20829-004

## ABSOLUTE MAXIMUM RATINGS

Table 4.

| Parameter  | Rating           |
|--|------------------|
| V50AMP1, V50AMP2   | -0.3 V to +5.5V  |
| V33FUSE  | -0.3 V to +3.6 V |
| VDAC   | -0.3 V to +3.6 V |
| VVA_ANALOG   | -0.3 V to +3.6 V |
| $\overline{CS}$ , SCLK, SDI, SDO, CS4, CS5, TXEN         | -0.3 V to +3.6 V |
| RF Input Power (IN_N, IN_P) at 50 $\Omega$               | 10 dBm           |
| Operating Temperature Range<br>(Measured at Exposed Pad) | -40°C to +105°C  |
| Junction Temperature Range                               | -40°C to +125°C  |
| Storage Temperature Range                                | -65°C to +150°C  |

Stresses at or above those listed under Absolute Maximum Ratings may cause permanent damage to the product. This is a stress rating only; functional operation of the product at these or any other conditions above those indicated in the operational section of this specification is not implied. Operation beyond the maximum operating conditions for extended periods may affect product reliability.

## THERMAL RESISTANCE

Thermal performance is directly linked to printed circuit board (PCB) design and operating environment. Careful attention to PCB thermal design is required.

$\theta_{JA}$  is the natural convection junction to ambient thermal resistance measured in a one cubic foot sealed enclosure.  $\theta_{JC}$  is the conduction thermal resistance from junction to case where the case temperature is measured at the bottom of the package.

The thermal resistance values specified in Table 5 are simulated based on JEDEC specifications (unless specified otherwise) and should be used in compliance with JESD51-12.

Table 5. Thermal Resistance<sup>1,2</sup>

| Package Type | $\theta_{JA}$ | $\theta_{JC\text{ BOTTOM}}$ | Unit |
|--------------|---------------|-----------------------------|------|
| CC-38-1      | 21.4          | 7.6                         | °C/W |

<sup>1</sup> For  $\theta_{JC\text{ BOTTOM}}$ , the case bottom is controlled at 105°C and the case top is controlled at 100°C.

<sup>2</sup> Using enhanced heat removal (for example, PCB, heat sink, and airflow) techniques to improve thermal resistance values.

## ESD CAUTION



### ESD (electrostatic discharge) sensitive device.

Charged devices and circuit boards can discharge without detection. Although this product features patented or proprietary protection circuitry, damage may occur on devices subjected to high energy ESD. Therefore, proper ESD precautions should be taken to avoid performance degradation or loss of functionality.

# PIN CONFIGURATION AND FUNCTION DESCRIPTIONS

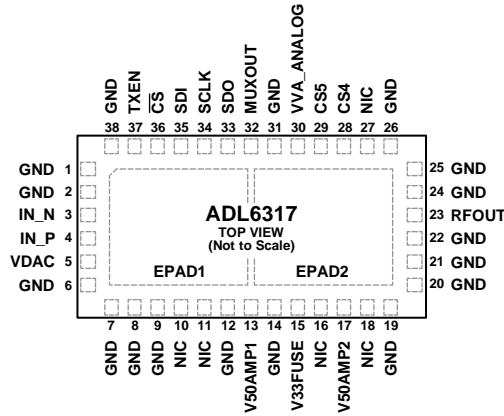

- NOTES
1. NIC = NOT INTERNALLY CONNECTED. THIS PIN HAS NO PHYSICAL CONNECTION WITHIN THE CHIP.
  2. EXPOSED PAD 1. EPAD1 IS INTERNALLY CONNECTED TO EPAD2. THE EXPOSED PAD MUST BE CONNECTED TO GROUND FOR ELECTRICAL AND THERMAL PURPOSES.
  3. EXPOSED PAD 2. EPAD2 IS INTERNALLY CONNECTED TO EPAD1. THE EXPOSED PAD MUST BE CONNECTED TO GROUND FOR ELECTRICAL AND THERMAL PURPOSES.

201823-005

Figure 5. Pin Configuration

Table 6. Pin Function Descriptions

| Pin No.  | Mnemonic   | Description  |
|--|------------|--|
| 1, 2, 6, 7, 8, 9, 12, 14, 19, 20, 21, 22, 24, 25, 26, 31, 38 | GND        | Ground.  |
| 3  | IN_N       | RF Input, Negative.  |
| 4  | IN_P       | RF Input, Positive.  |
| 5  | VDAC       | Supply Voltage for External RF DAC. This pin can be left open during operation without the RF DAC.   |
| 10, 11, 16, 18, 27   | NIC        | No Internal Connection. These pins have no physical connection within the chip.  |
| 13   | V50AMP1    | Amplifier 1 Analog Power Supply (5.0 V).   |
| 15   | V33FUZE    | VCO Low Dropout (LDO) Regulator Bypass. This pin is optionally 3.3 V when the 3.3 V LDO regulator is off.  |
| 17   | V50AMP2    | Amplifier 2 Analog Power Supply (5.0 V).   |
| 23   | RFOUT      | RF Output.   |
| 28, 29   | CS4, CS5   | Chip Select. Connect these pins to ground. Refer to the Multiple Chip Operation to Share SPI Bus section for information about the connections in a multiple chip operation. |
| 30   | VVA_ANALOG | Analog Voltage Control for VVA.  |
| 32   | MUXOUT     | Test Mux Output.   |
| 33   | SDO        | Serial Port Data Output.   |
| 34   | SCLK       | Serial Port Clock Input.   |
| 35   | SDI        | Serial Port Data Input.  |
| 36   | CS         | Serial Port Latch Enable Input.  |
| 37   | TXEN       | Amplifier Enable, DSA Attenuation, and Trim Value Selection.   |
|  | EPAD1      | Exposed Pad 1. EPAD1 is internally connected to EPAD2. The exposed pad must be connected to ground for electrical and thermal purposes.                                      |
|  | EPAD2      | Exposed Pad 2. EPAD2 is internally connected to EPAD1. The exposed pad must be connected to ground for electrical and thermal purposes.                                      |

# TYPICAL PERFORMANCE CHARACTERISTICS

$V_{50AMP1} = V_{50AMP2} = 5\text{ V}$ ,  $T_A = 25^\circ\text{C}$ , input power =  $-25\text{ dBm}$  ( $-25\text{ dBm}$  per tone for two tones), VVA attenuation =  $0\text{ dB}$ , DSA attenuation =  $0\text{ dB}$ ,  $R_S = R_L = 50\ \Omega$ , unless otherwise noted.

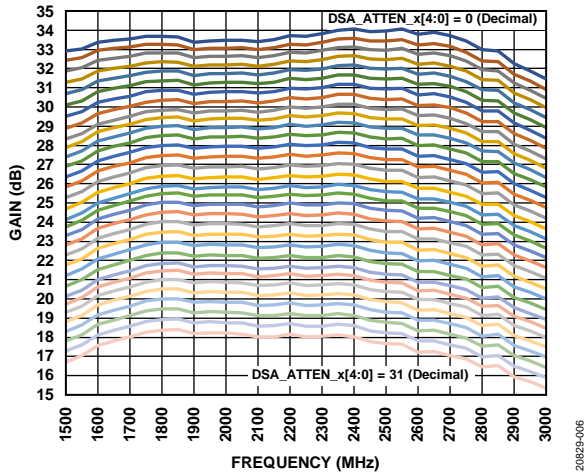

Figure 6. Gain vs. Frequency, 0.5 dB DSA Steps

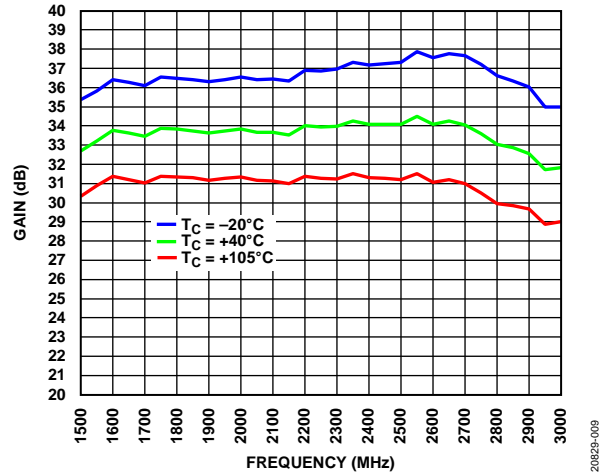

Figure 9. Gain vs. Frequency for Various Temperatures

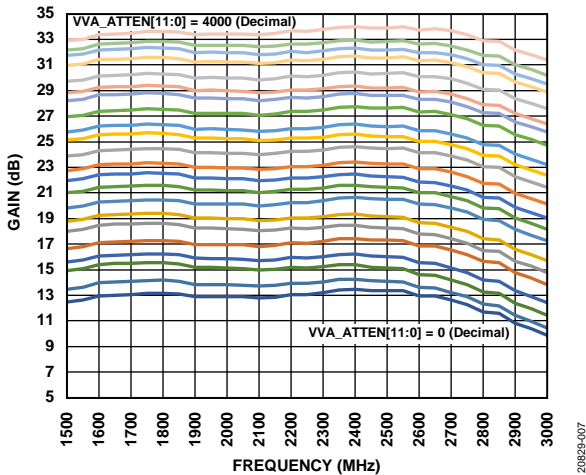

Figure 7. Gain vs. Frequency, 100 VVA\_ATTEN[11:0] Steps

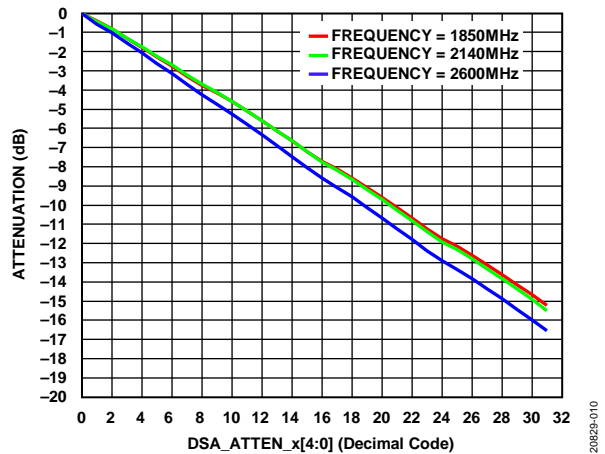

Figure 10. Attenuation vs. DSA\_ATTEN\_x[4:0] at 1850 MHz, 2150 MHz, and 2600 MHz, VVA Attenuation =  $0\text{ dB}$

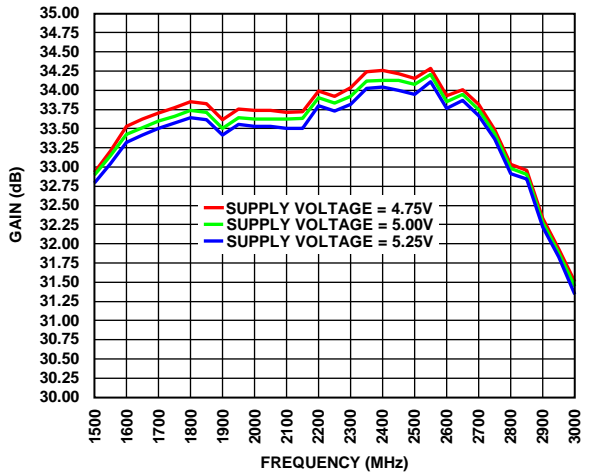

Figure 8. Gain vs. Frequency for Various Supplies

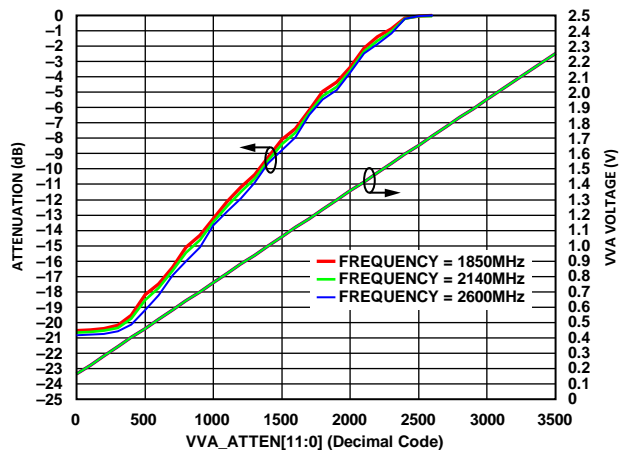

Figure 11. Attenuation and VVA Voltage vs. VVA\_ATTEN[11:0] at 1850 MHz, 2150 MHz, and 2600 MHz, DSA Attenuation =  $0\text{ dB}$



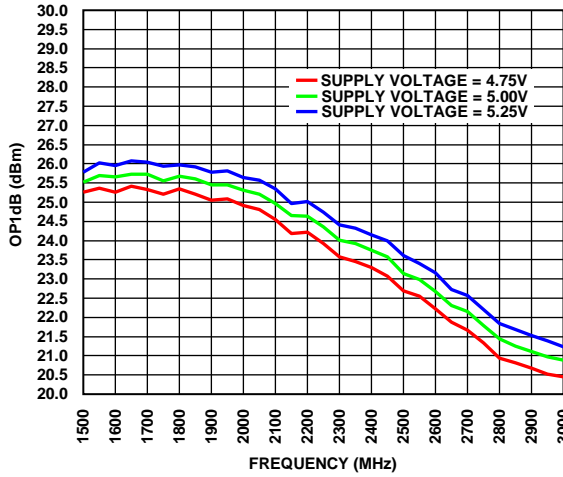

Figure 12. OP1dB vs. Frequency for Various Supplies

20829-012

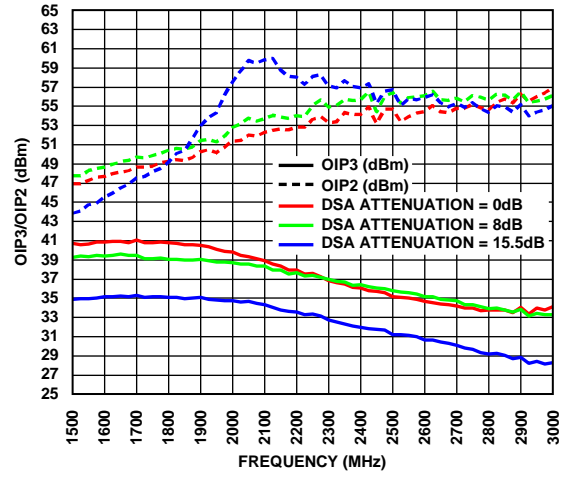

Figure 15. OIP3/OIP2 vs. Frequency at Various DSA Values, VVA Attenuation = 0 dB

20829-015

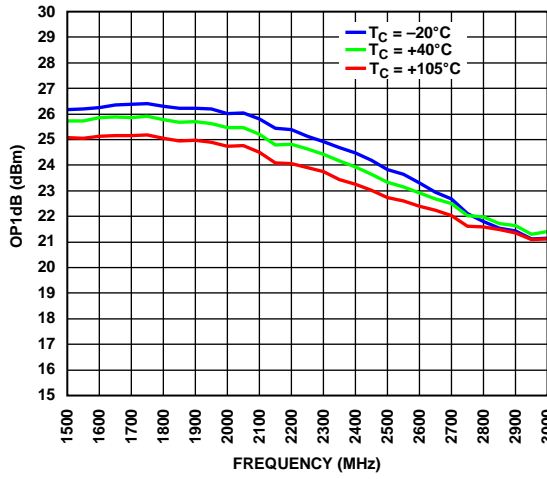

Figure 13. OP1dB vs. Frequency for Various Temperatures

20829-013

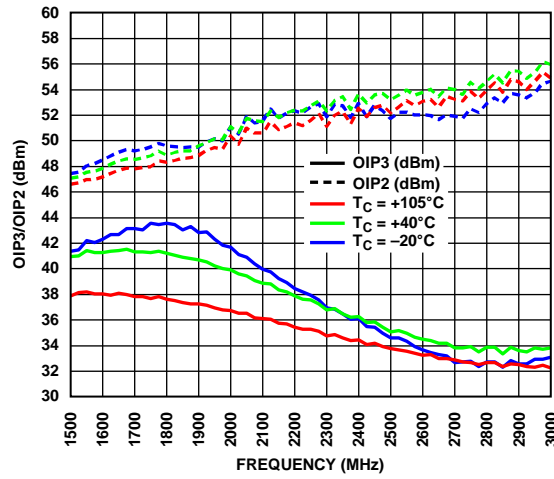

Figure 16. OIP3/OIP2 vs. Frequency for Various Temperatures

20829-016

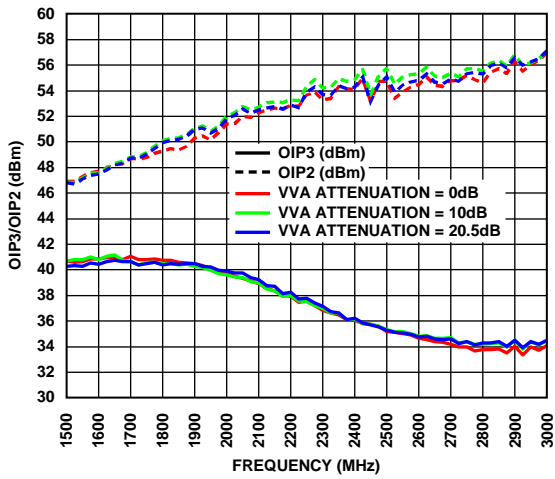

Figure 14. OIP3/OIP2 vs. Frequency at Various VVA Attenuation Values, DSA Attenuation = 0 dB

20829-014

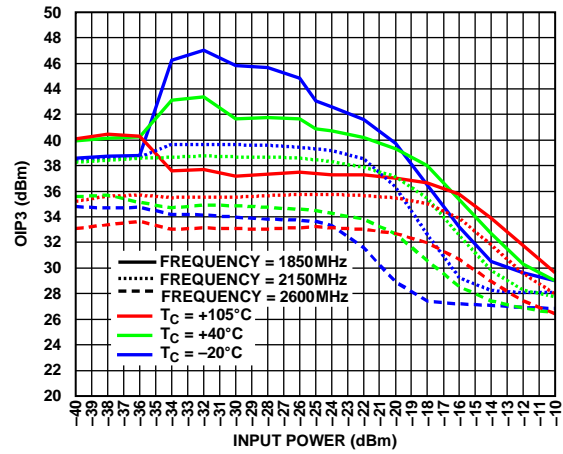

Figure 17. OIP3 vs. Input Power for Various Temperatures at 1850 MHz, 2150 MHz, and 2600 MHz

20829-017

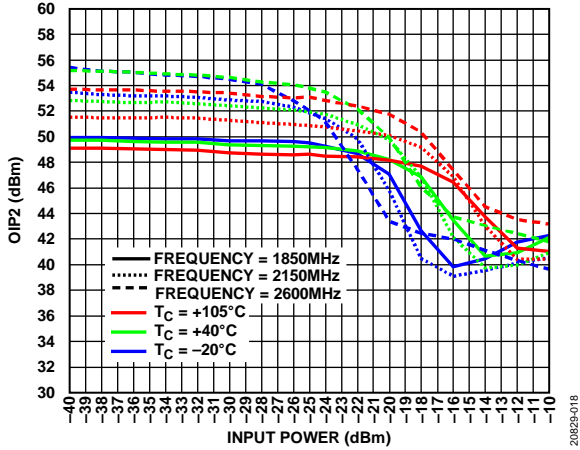

Figure 18. OIP2 vs. Input Power for Various Temperatures at 1850 MHz, 2150 MHz, and 2600 MHz

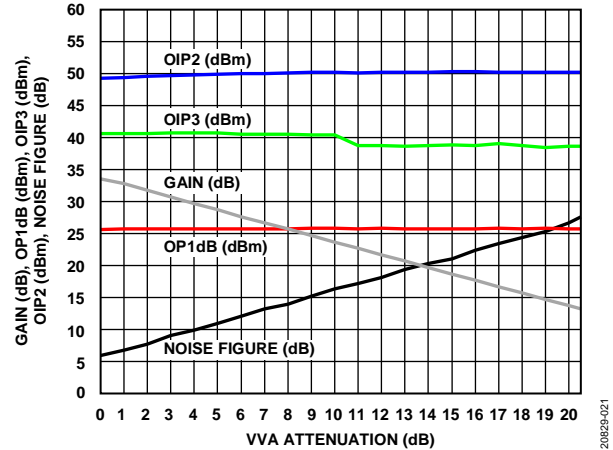

Figure 21. Gain, OP1dB, OIP3, OIP2, Noise Figure vs. VVA Attenuation, DSA Attenuation = 0 dB, Frequency = 1850 MHz

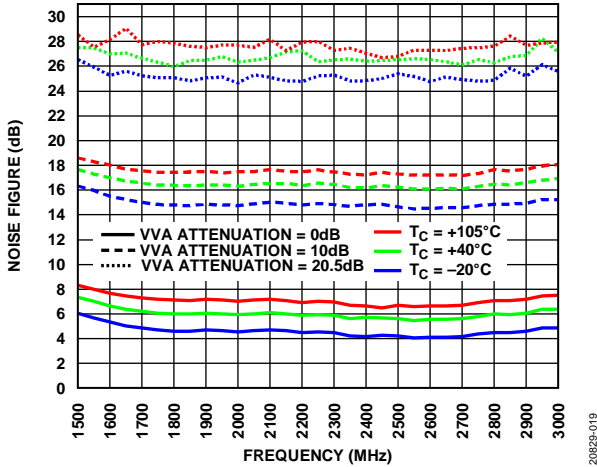

Figure 19. Noise Figure vs. Frequency for Various Temperatures at Various VVA Values, DSA Attenuation = 0 dB

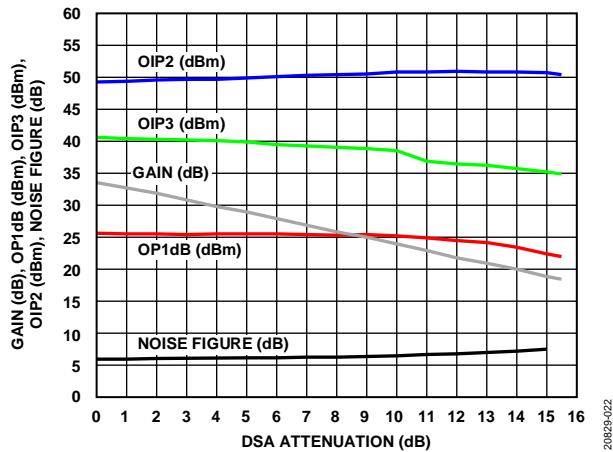

Figure 22. Gain, OP1dB, OIP3, OIP2, Noise Figure vs. DSA Attenuation, VVA Attenuation = 0 dB, Frequency = 1850 MHz

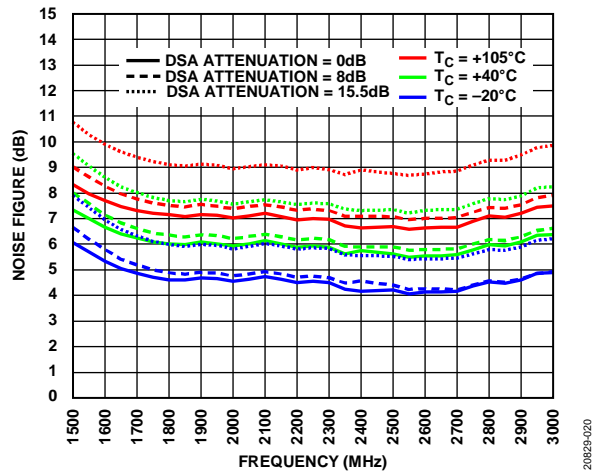

Figure 20. Noise Figure vs. Frequency for Various Temperatures at Various DSA Values, VVA Attenuation = 0 dB

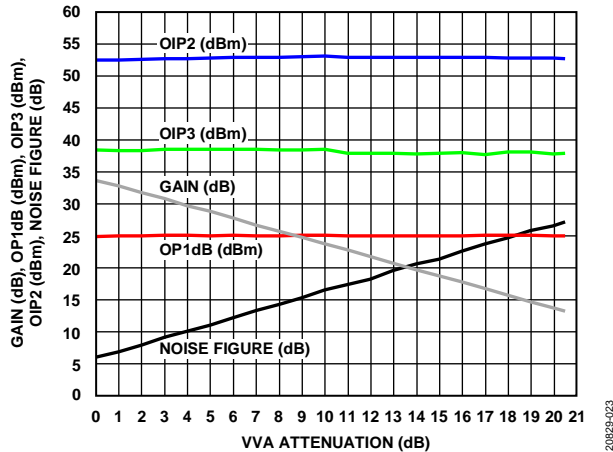

Figure 23. Gain, OP1dB, OIP3, OIP2, Noise Figure vs. VVA Attenuation, DSA Attenuation = 0 dB, Frequency = 2150 MHz

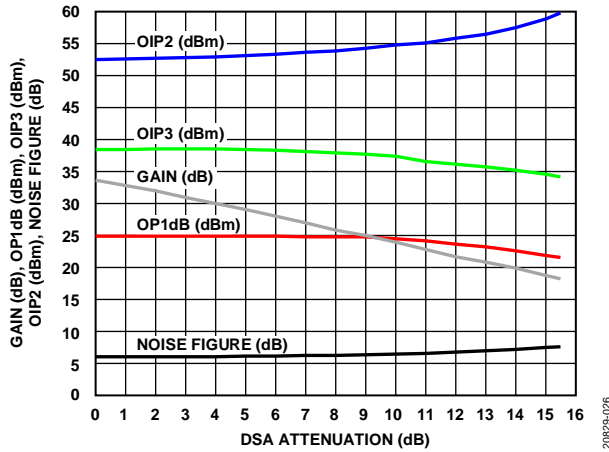

Figure 24. Gain, OP1dB, OIP3, OIP2, Noise Figure vs. DSA Attenuation, VVA Attenuation = 0 dB, Frequency = 2150 MHz

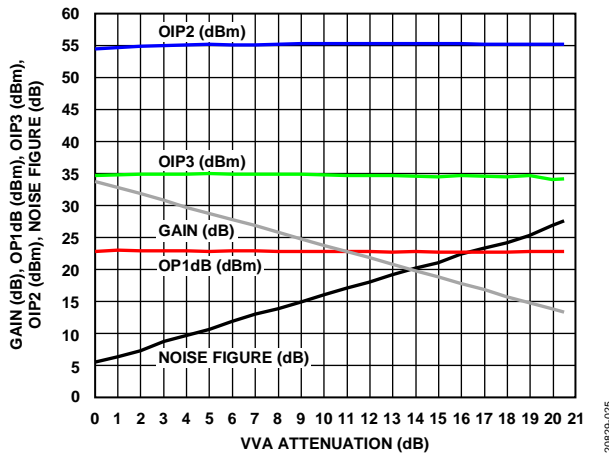

Figure 25. Gain, OP1dB, OIP3, OIP2, Noise Figure vs. VVA Attenuation, DSA Attenuation = 0 dB, Frequency = 2600 MHz

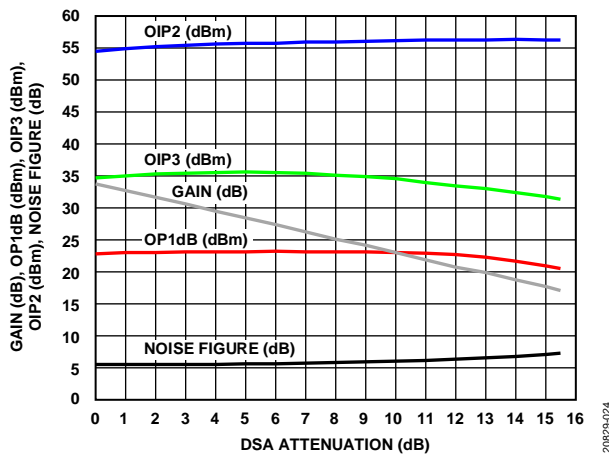

Figure 26. Gain, OP1dB, OIP3, OIP2, Noise Figure vs. DSA Attenuation, VVA Attenuation = 0 dB, Frequency = 2600 MHz

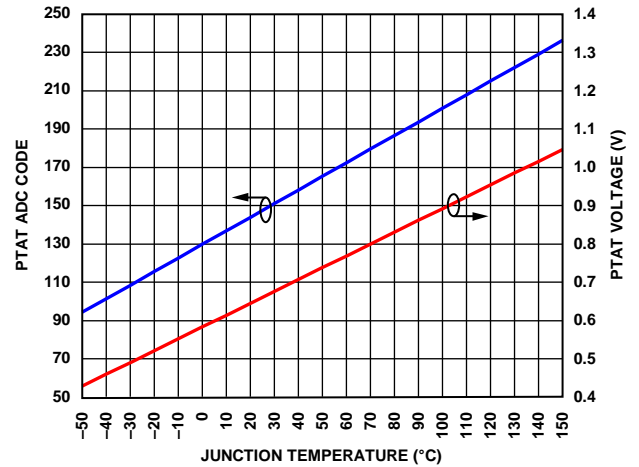

Figure 27. Proportional to Absolute Temperature (PTAT) ADC Code and PTAT Voltage vs. Junction Temperature

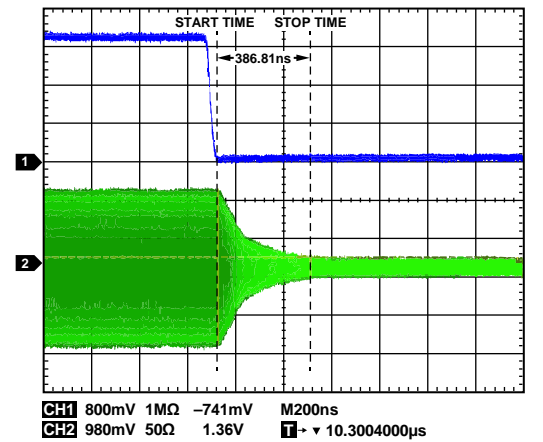

Figure 28. VVA Gain Settling Time, Minimum to Maximum VVA Attenuation

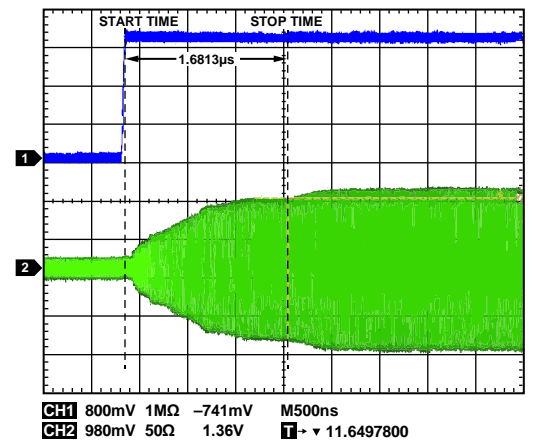

Figure 29. VVA Gain Settling Time, Maximum to Minimum VVA Attenuation

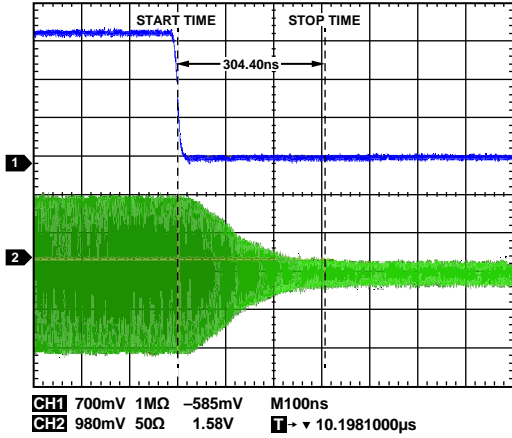

Figure 30. DSA Gain Settling Time, Minimum to Maximum DSA Attenuation

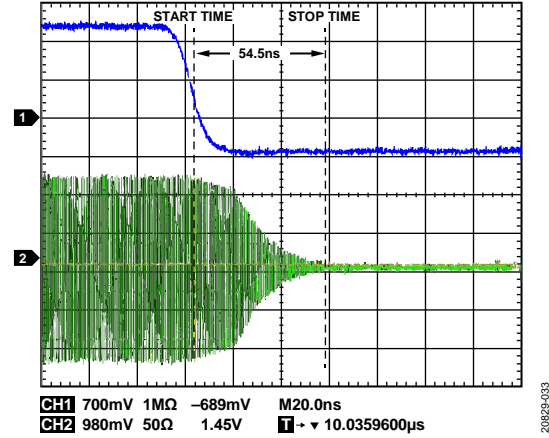

Figure 33. TXEN Response Time Measured from Amplifier 1 and Amplifier 2 Enabled (DSA = 0 dB) to Amplifier 1 and Amplifier 2 Disabled (DSA = 15.5 dB)

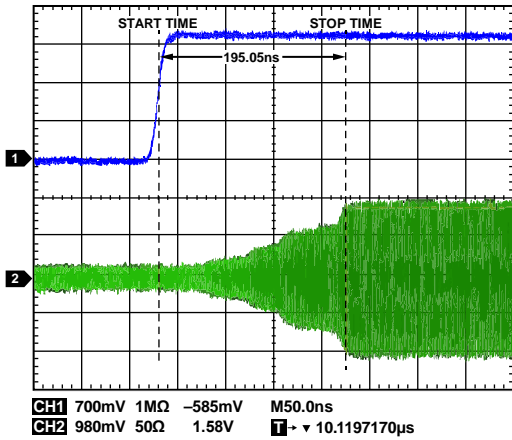

Figure 31. DSA Gain Settling Time, Maximum to Minimum DSA Attenuation

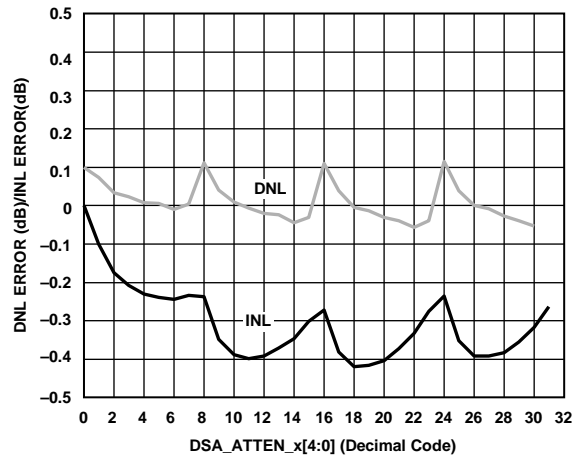

Figure 34. DSA Gain Step Error, Frequency = 1850 MHz

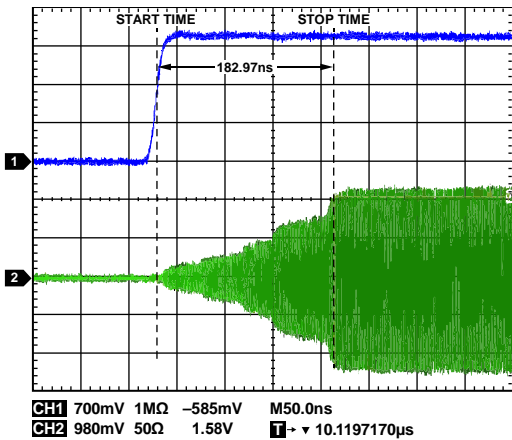

Figure 32. TXEN Response Time, Measured from Amplifier 1 and Amplifier 2 Disabled (DSA Attenuation = 15.5 dB) to Amplifier 1 and Amplifier 2 Enabled, (DSA Attenuation = 0 dB)

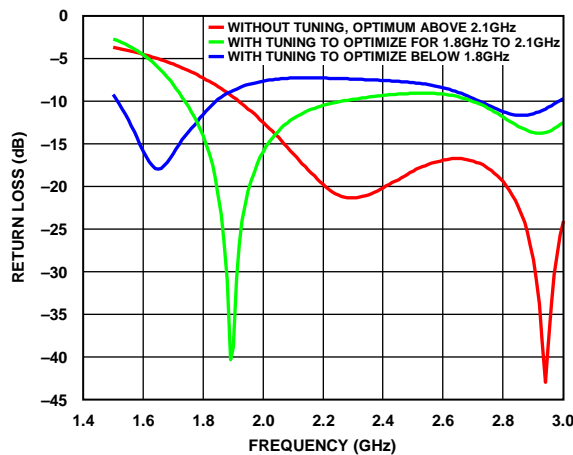

Figure 35. Return Loss of Differential RF Input S11 from 1.5 GHz to 3 GHz

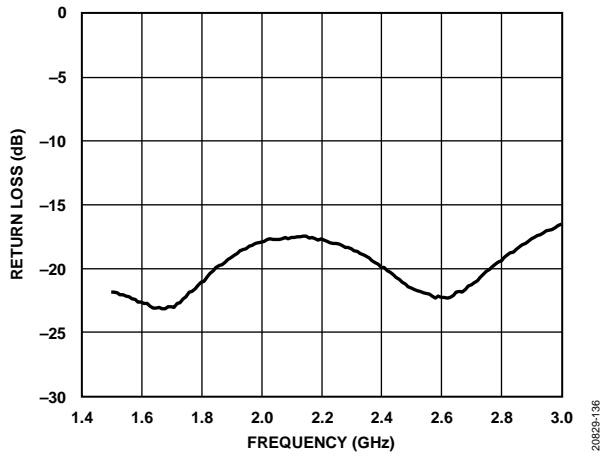

Figure 36. Return Loss of Single-Ended RF Output S22 from 1.5 GHz to 3 GHz

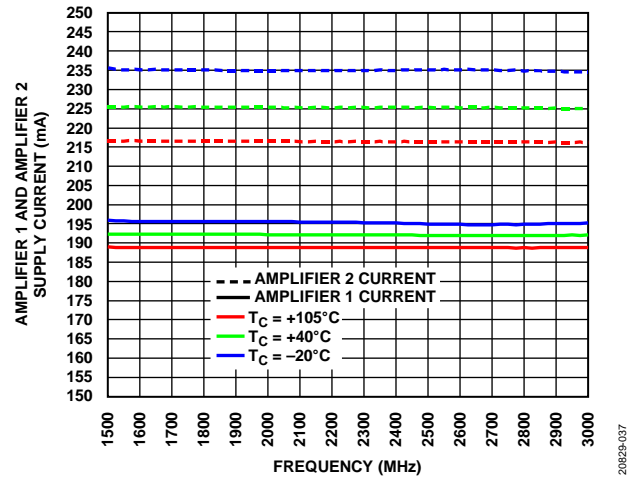

Figure 37. Amplifier 1 and Amplifier 2 Supply Current vs. Frequency for Various Temperatures

## THEORY OF OPERATION

The ADL6317 is a highly integrated transmit VGA used to interface an RF DAC to the power amplifier in a transmitter. The ADL6317 targets high dynamic range multicarrier transmitter designs.

The ADL6317 offers multiple gain control options with an integrated 20.5 dB VVA, on-chip DAC control or external voltage control, a high linearity amplifier, an RF DSA with a 15.5 dB attenuation range in 0.5 dB steps, followed by the second stage high linearity amplifier.

Putting all the building blocks of the ADL6317 together, the signal path through the device starts with differential inputs converted to singled-ended by the integrated balun and this single-ended signal is then quadrature coupled by the internal quadrature hybrid.

Next, the integrated VVA, Amplifier 1, DSA, and Amplifier 2 optimize the RF signal amplitude for performance before the RF signal passes through the output quadrature hybrid. All the integrated building blocks of the ADL6317 are programmable via the SPI.

### RF INPUT BALUN WITH DAC INTERFACE NETWORK

The ADL6317 converts a single-channel, 50 Ω, input differential signal to a single-ended signal via the integrated balun. Wideband matching allows the DAC to operate over a frequency range from 1500 MHz to 3000 MHz, and a bias tee is included to provide dc bias for the RF DAC.

### QUADRATURE HYBRID

Integrated quadrature hybrids at the RF input and RF output allow wideband performance gain and match with a low input and output reflection coefficient to the RF DAC and PA.

### RF SIGNAL CHAIN

The RF path includes a 20.5 dB VVA, the first stage of the fixed gain amplifier, a 15.5 dB DSA, and the second stage of the fixed gain amplifier (see Figure 38). The ADL6317 has two modes of control of the VVA attenuation: internal analog control using an integrated 12-bit DAC and external analog control. For internal control, use Register 0x104, Bits[3:0] and Register 0x103, Bits[7:0] to set the attenuation. The digital bits are double buffered to avoid major carrier glitch. For this reason, Register 0x104 must be written before Register 0x103. For external analog control of the VVA, a control voltage is applied to the VVA\_ANALOG pin (Pin 30). Sample register writes for VVA control are shown in Figure 38.

Table 7. Register Writes for the Control of VVA

| Address | Bits  | Settings     | Description  |
|---------|-------|--------------|--|
| 0x105   | [1:0] | 00           | DAC to VVA   |
|         |       | 10           | VVA_ANALOG (Pin 30) to VVA   |
| 0x104   | [3:0] | User defined | 12-bit DAC code to set VVA attenuation; first, write to Register 0x104, Bits[3:0], and then to Register 0x103, Bits[7:0] |
| 0x103   | [7:0] | User defined |  |

Next, the fixed gain amplifier is used in a quadrature balanced configuration. The DSA provides a 15.5 dB range with 0.5 dB step resolution. The digital 5-bit DSA attenuation control is found in Bits[4:0] of Register 0x102 and Register 0x112. Finally, the second stage fixed gain amplifier is used in a quadrature balanced configuration.

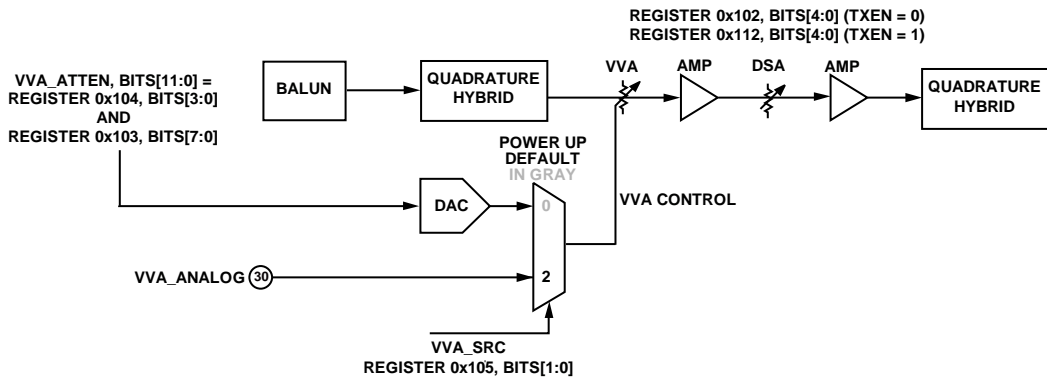

Figure 38. RF Signal Chain

20629-038

# BASIC CONNECTIONS

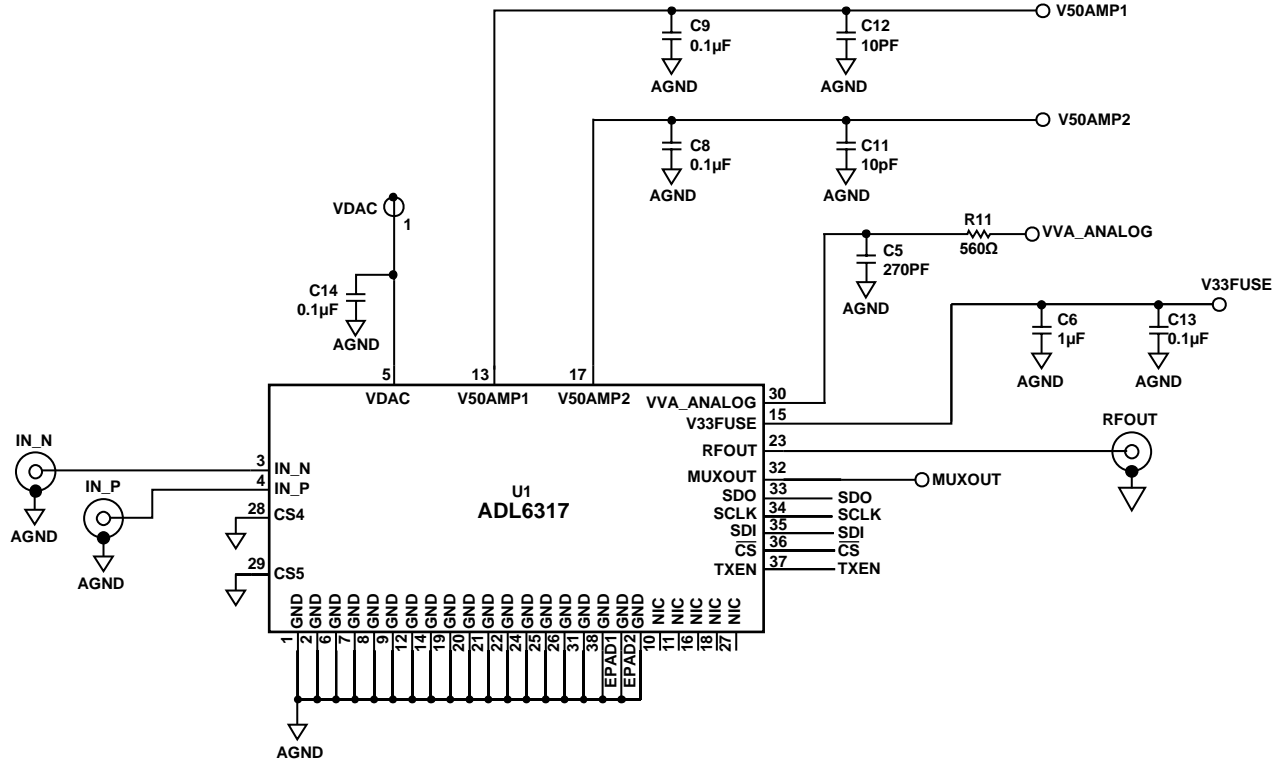

Figure 39. Basic Connections

Table 8. Basic Connections

| Functional Blocks | Pin No.  | Mnemonic         | Description   | Basic Connection  |
|-------------------|--|------------------|---|---|
| 5 V               | 13, 17   | V50AMP1, V50AMP2 | Amplifier analog supply voltage, 5 V                        | Decouple these pins via 10 pF and 0.1 µF capacitors to ground. Ensure that the decoupling capacitors are located close to the pins.                           |
| Decoupling        | 15   | V33FUSE          | 3.3 V LDO regulator decoupling                              | Decouple this pin via 0.1 µF and 1 µF capacitors to ground. Ensure that the decoupling capacitors are located close to the pin.                               |
| RF Inputs         | 5  | VDAC             | Supply voltage for external RF DAC                          | VDAC can be left open during operation without the RF DAC.  |
|                   | 3, 4   | IN_N, IN_P       | Differential RF inputs                                      | Connect the IN_N and IN_P pins to an RF DAC or transceiver output in differential configuration.  |
| VVA               | 30   | VVA_ANALOG       | External VVA control voltage input                          | Voltage input pin to control VVA attenuation.   |
| RF Output         | 23   | RFOUT            | Single-ended RF output                                      | Connect RF output to power meter, network analyzer, noise figure meter, or spectrum analyzer.   |
| Serial Port       | 33   | SDO              | SPI data output   | 1.8 V to 3.3 V tolerant logic levels.   |
|                   | 34   | SCLK             | SPI clock   | 1.8 V to 3.3 V tolerant logic levels.   |
|                   | 35   | SDI              | SPI data input  | 1.8 V to 3.3 V tolerant logic levels.   |
|                   | 36   | CS               | Chip select active low                                      | 1.8 V to 3.3 V tolerant logic levels.   |
| Auxiliary Mux     | 32   | MUXOUT           | Mux output  | Connect mux output to multimeter, oscilloscope, or spectrum analyzer.   |
| Chip Selection    | 28, 29   | CS4, CS5         | Chip selection  | Connect these pins to ground.   |
| Mode Control      | 37   | TXEN             | Amplifier enable, DSA attenuation, and trim value selection | 1.8 V to 3.3 V tolerant logic levels.   |
| Ground            | 1, 2, 6 to 9, 12, 14, 19 to 22, 24 to 26, 31, 38 | GND              | Ground  | Connect these pins to the ground of the PCB.  |
| Exposed Pad       | Not applicable                                   | EPAD1, EPAD2     | Exposed pads  | The exposed thermal pads are on the bottom of the package. Solder the exposed pads to the PCB ground. EPAD1 and EPAD2 are internally connected to each other. |

## PROGRAMMABILITY GUIDE

Viewing the register map at the highest level, the registers are subdivided into the major functional blocks, as shown in Table 9. See the Register Summary section for a complete list of all the registers on the ADL6317.

**Table 9. Memory Map Functional Groups**

| Register Address      | Functional Blocks  |
|-----------------------|--|
| 0x000 to 0x011        | Analog Devices, Inc., SPI configuration                          |
| 0x100 to 0x101, 0x106 | Signal path enable   |
| 0x103 to 0x105        | VVA source, VVA attenuation                                      |
| 0x10B, 0x11B          | Amplifier 2 optimization   |
| 0x102, 0x107 to 0x10A | DSA attenuation, amplifier enable, amplifier trim, TXEN = 0 mode |
| 0x112, 0x117 to 0x11A | DSA attenuation, amplifier enable, amplifier trim, TXEN = 1 mode |
| 0x120 to 0x121        | Auxiliary mux selection, SPI supply control                      |
| 0x127 to 0x129        | ADC clock, temperature readback                                  |
| 0x146 to 0x148        | VVA and DSA attenuation readback                                 |

### SIGNAL PATH MODES

The ADL6317 has two signal path modes. This feature allows two predefined modes of operation to be controlled by TXEN, a real-time external pin with no SPI latency. Table 10 shows the hardware configuration to select the desired mode.

**Table 10. Mode Selection and Setup Registers**

| TXEN (Pin 37) | Mode     | Enable, Setup Register |
|---------------|----------|------------------------|
| 0             | TXEN = 0 | 0x102, 0x107 to 0x10A  |
| 1             | TXEN = 1 | 0x112, 0x117 to 0x11A  |

The controls of each mode of operation reside in a designated subsection of the register map. Each operational mode includes individual control of the enables of the amplifier blocks, DSA attenuation, and power mode. Control of these functions reside in Register 0x102 and Register 0x107 to Register 0x10A for TXEN = 0 mode, or Register 0x112 and Register 0x117 to Register 0x11A for TXEN = 1 mode. The specific mode selected by the logic level on the TXEN pin (Pin 37) determines the state of the registers (see Table 11).

**Table 11. Control Registers for the Modes**

| Register Address | Mode     | Function Block           |
|------------------|----------|--------------------------|
| 0x102            | TXEN = 0 | DSA attenuation          |
| 0x112            | TXEN = 1 | DSA attenuation          |
| 0x107            | TXEN = 0 | Amplifier 1 optimization |
| 0x117            | TXEN = 1 | Amplifier 1 optimization |
| 0x108            | TXEN = 0 | Amplifier 1 enable       |
| 0x118            | TXEN = 1 | Amplifier 1 enable       |
| 0x109            | TXEN = 0 | Amplifier 2 optimization |
| 0x119            | TXEN = 1 | Amplifier 2 optimization |
| 0x10A            | TXEN = 0 | Amplifier 2 enable       |
| 0x11A            | TXEN = 1 | Amplifier 2 enable       |

### Signal Path Enable

The signal path enable bits are located in Register 0x100, Register 0x108, Register 0x118, Register 0x10A, and Register 0x11A. Figure 40 shows a breakdown of the individual blocks that the particular enable bit controls.

### AUXILIARY MUX CONTROL

The ADL6317 has multiple auxiliary mux control blocks that allow various modes of operation and monitoring points (see Figure 41 and Table 12).

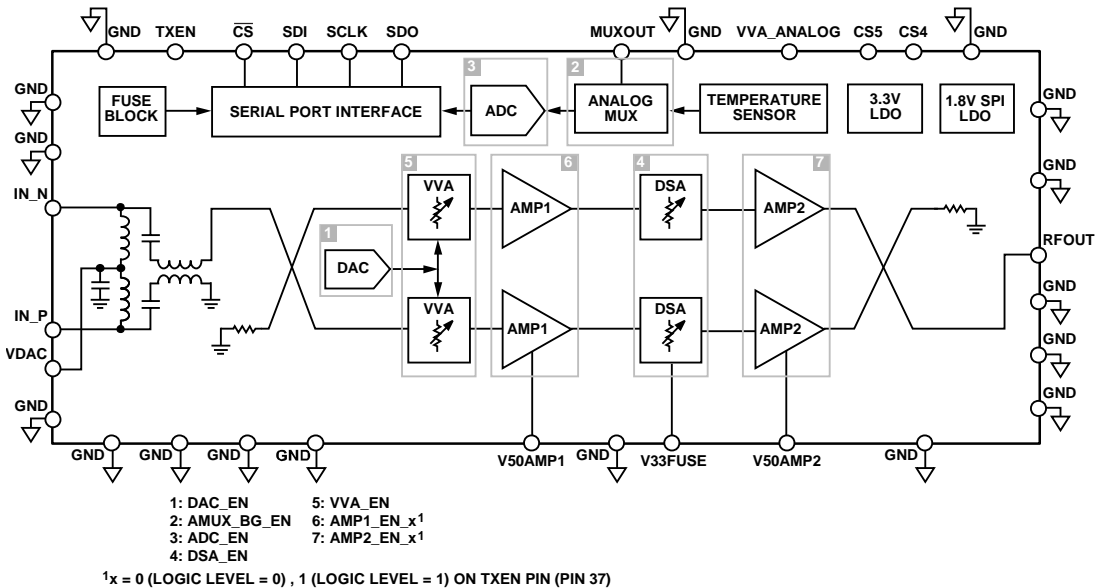

Figure 40. Signal Path Enable Block Diagram



(REGISTER 0x104, BITS[ 3:0], REGISTER 0x103, BITS[7:0]) = VVA\_ATTEN, BITS[11:0]

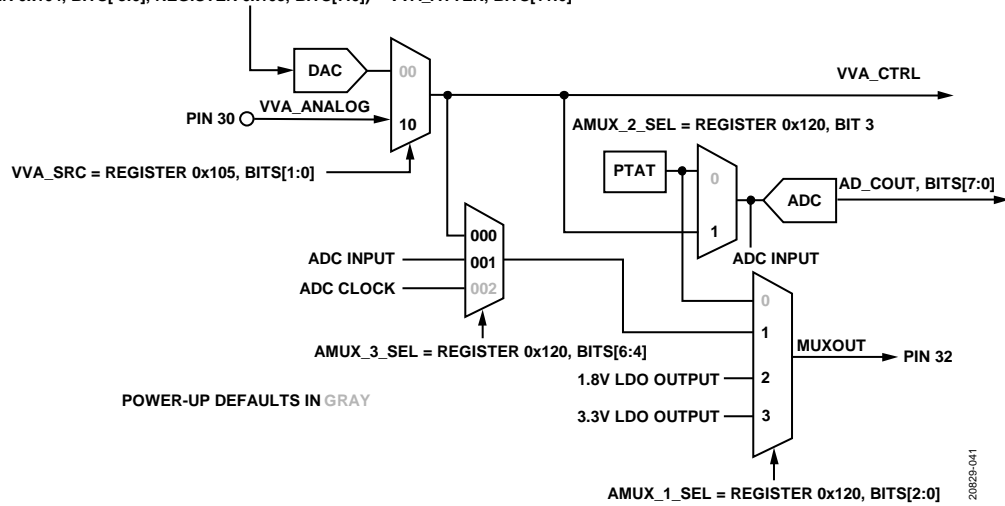

Figure 41. Auxiliary Mux Block Diagram

Table 12. Auxiliary Mux Programming Guide

| Bit Name   | Register Address          | Setting | Description  |
|------------|---------------------------|---------|--|
| AMUX_3_SEL | Register 0x120, Bits[6:4] | 000     | ADC input, VVA_CTRL, and ADC clock selection on mux. VVA_CTRL is the internal control voltage signal to control VVA attenuation. |
|            |                           | 001     | VVA_CTRL.  |
|            |                           | 010     | ADC input.   |
|            |                           | 011     | ADC clock.   |
|            |                           | 100     | Not used.  |
|            |                           | 101     | Not used.  |
|            |                           | 110     | Not used.  |
|            |                           | 111     | Not used.  |
| AMUX_2_SEL | Register 0x120, Bit 3     | 0       | ADC input selection.<br>PTAT to ADC input.   |
|            |                           | 1       | VVA_CTRL to ADC input.   |
| AMUX_1_SEL | Register 0x120, Bits[2:0] | 000     | Select mux output.<br>PTAT.  |
|            |                           | 001     | Output of AMUX_3_SEL.  |
|            |                           | 010     | 1.8 V LDO output.  |
|            |                           | 011     | 3.3 V LDO output.  |
|            |                           | 100     | GND.   |
|            |                           | 101     | GND.   |
|            |                           | 110     | Not used.  |
|            |                           | 111     | Not used.  |

## SERIAL PORT INTERFACE (SPI)

The SPI of the ADL6317 allows the user to configure the device for specific functions or operations via a 4-wire SPI port. This interface provides users with added flexibility and customization. The serial port interface consists of four control lines: SCLK, SDI, SDO, and CS. The timing requirements for the SPI port are shown in Table 3.

The ADL6317 protocol consists of a read/write bit, six chip select ID bits, and nine register address bits, followed by eight data bits. Both the address and data fields are organized with the MSB first and end with the LSB by default.

The ADL6317 input logic level for the write cycle is with a 1.8 V logic level (see the digital logic parameter in Table 2).

On a read cycle, the SDO is configurable for 1.8 V (default) or 3.3 V output levels by setting SPI\_1P8\_3P3\_CTRL bit (Register 0x121, Bit 4).

### Multiple Chip Operation to Share SPI Bus

Multiple ADL6317 devices, up to four, can be addressed using the same 4-wire SPI, which means no extra CS line for each device. For this capability, the chip ID bits of the ADL6317 are reserved as the chip ID (see the SPI interface port as shown in Figure 2).

The ADL6317 ignores any writes to addresses where the six MSBs are not equal to the chip ID, with the exception of

Register 0x000 to Register 0x00B. The ADL6317 always accepts writes for these registers regardless of the six MSBs of the address.

The ADL6317 only accepts reads for addresses where the six MSBs are equal to the chip ID, including Register 0x000 to Register 0x00B.

Figure 42 shows how to configure the chip ID and the CS5 and CS4 pins to share a 4-wire SPI. The CS5 and CS4 settings are shown in gray in Figure 42.

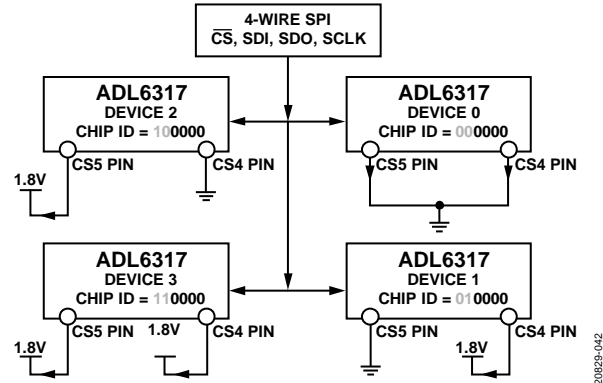

Figure 42. Multiple Chip Configuration to Share SPI Bus

208523-1042

## DEVICE SETUP

The recommended sequence of steps to set up the ADL6317 is as follows:

1. Set up the SPI interface. See Table 13.
2. Set up the common parameters, including auxiliary mux control. See Table 14 and Table 15.
3. Set up the operating mode. See Table 16 to Table 19.
  - a. Set the attenuation on the DSA.
  - b. Enable or disable the amplifiers.
  - c. Set the amplifier reference currents.
  - d. Set the amplifier for linearity optimization.
  - e. Measure the internal temperature.

**Table 13. SPI Interface Setup**

| Address | Setting | Notes  |
|---------|---------|--|
| 0x000   | 0x99    | Soft reset, MSB first, SDO active (4-wire SPI)                                   |
| 0x001   | 0x00    | Single instruction, master/slave readback, soft reset, and master/slave transfer |
| 0x00A   | 0x00    | Scratch pad  |

**Table 14. Signal Path Trim**

| Address | Setting | Description   |
|---------|---------|---|
| 0x100   | 0xFF    | Enable the DAC, auxiliary mux band gap, ADC, bias generator, DSA, and VVA                 |
| 0x101   | 0x01    | Enable IP3 optimization and 3.3 V LDO regulator   |
| 0x106   | 0x00    | Disable the bias current, $I_{BIAS}$ , via the EN_IBIASGEN_RESISTOR bit (default setting) |
| 0x105   | 0x00    | VVA control source from DAC   |
| 0x104   | 0x0F    | Attenuation of VVA at minimum attenuation, highest four bits of 12-bit word               |
| 0x103   | 0xFF    | Attenuation of VVA at minimum attenuation, lowest eight bits of 12-bit word               |

**Table 15. Auxiliary Mux Control**

| Address | Setting | Description                           |
|---------|---------|---------------------------------------|
| 0x120   | 0x00    | PTAT to ADC input, PTAT on mux output |
| 0x121   | 0x00    | Set SPI SDO voltage to 1.8 V          |

**Table 16. Power-Down Mode Setup, TXEN = Logic Level 0**

| Address | Setting | Description  |
|---------|---------|--|
| 0x102   | 0x1F    | 15.5 dB attenuation on DSA   |
| 0x107   | 0x80    | Set Amplifier 1 reference current, $I_{REF}$ (TRM_AMP1_IREF_0), for low power mode |
| 0x108   | 0x80    | Disable Amplifier 1  |
| 0x109   | 0x80    | Set Amplifier 2 $I_{REF}$ (TRM_AMP2_IREF_0) for low power mode                     |
| 0x10A   | 0x80    | Disable Amplifier 2  |

**Table 17. Normal Operating Mode Setup, TXEN = Logic Level 1**

| Address | Setting | Description                                 |
|---------|---------|---|
| 0x112   | 0x00    | 0 dB attenuation on DSA                     |
| 0x117   | 0x82    | Set Amplifier 1 $I_{REF}$ (TRM_AMP1_IREF_1) |
| 0x118   | 0x81    | Enable Amplifier 1                          |
| 0x119   | 0x82    | Set Amplifier 2 $I_{REF}$ (TRM_AMP2_IREF_1) |
| 0x11A   | 0x81    | Enable Amplifier 2                          |

**Table 18. Linearity Optimization**

| Address | Setting | Description              |
|---------|---------|--------------------------|
| 0x10B   | 0x02    | Set the TRM_AMP2_CB bit  |
| 0x11B   | 0x02    | Set the TRM_AMP2_IP3 bit |

Table 19. Internal Temperature Measurement from ADC Conversion

| Address | Setting        | Description  |
|---------|----------------|--|
| 0x000   | 0x18           | Make SDO active                                      |
| 0x100   | 0xFF           | Enable ADC   |
| 0x127   | 0x20           | Enable ADC clock divider and set ADC clock frequency |
| 0x120   | 0x00           | PTAT to ADC input, PTAT on mux output                |
| 0x00A   | 0xCC           | Register dummy write                                 |
| 0x00A   | 0xCC           | Register dummy write                                 |
| 0x00A   | 0xCC           | Register dummy write                                 |
| 0x00A   | 0xCC           | Register dummy write                                 |
| 0x00A   | 0xCC           | Register dummy write                                 |
| 0x129   | Not applicable | Read temperature from ADC                            |

# APPLICATIONS INFORMATION

## LINEARITY OPTIMIZATION

The linearity in the ADL6317 can be optimized through the TRM\_AMP2\_IP3 (Register 0x11B, Bits[1:0]) and TRM\_AMP2\_CB (Register 0x10B, Bits[1:0]) settings. Set the IP3\_OFF bit (Register 0x101, Bit 1) 0x00 for OIP3 optimization. The TRM\_AMP2\_IP3 bits control the switches in the second amplifier that enables optimal third-order distortion cancellation and optimal OIP3. The TRM\_AMP2\_CB bits control the common base bias current on the transistor and allows additional linearity optimization.

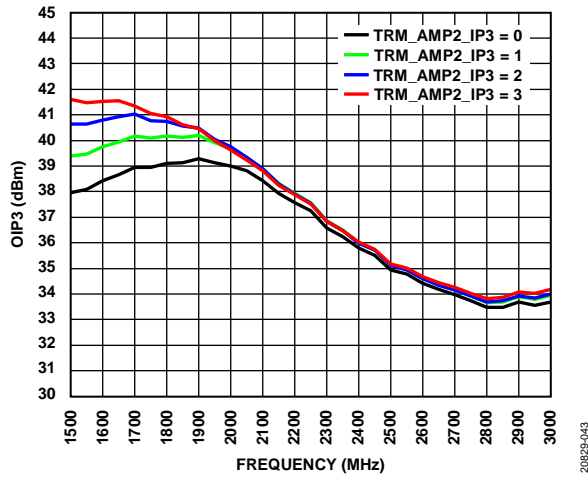

Figure 43. OIP3 vs. RF Frequency for Various TRM\_AMP2\_IP3 Settings, TRM\_AMP2\_CB = 0x02, TRM\_AMP1\_IREF\_x and TRM\_AMP2\_IREF\_x = 0x02

Figure 43 shows that the OIP3 is optimizable across the TRM\_AMP2\_IP3 settings.

Figure 43 shows better than 1.5 dB OIP3 improvement that correlates to 3 dB improvement on IMD3 performance at below 1.9 GHz through linearity optimization.

## PERFORMANCE AND POWER OPTIMIZATION

The ADL6317 provides another level of control to optimize power or performance. In applications where performance is critical, the ADL6317 offers performance optimization at the expense of power consumption. However, if low power is the priority, the ADL6317 offers tuning options in the amplifier blocks of the chip to further reduce power consumption.

Table 20 shows that the potential power optimization vs. performance can fine tune the reference current on RF amplifier settings.

## ADJACENT AND ALTERNATE CHANNEL POWER RATIOS ON LTE OPERATION

Figure 44 shows the adjacent and alternate channel power ratios (CPR) for the ADL6317 using 5 MHz single-carrier LTE. The adjacent CPR is -70.4 dB and the alternative CPR is -72.9 dB at an RF of 1850 MHz. The adjacent and alternate CPR performance varies over output power. On the ADL6317, the output power can be varied by adjusting the input power, the VVA attenuation, or the DSA attenuation. Figure 45 to Figure 47 show the adjacent and alternate CPR performance vs. output power for the different methods of controlling the ADL6317.

As shown in Figure 45, the optimum adjacent and alternate CPR can be achievable at an output power of +8 dBm, which corresponds to an input power of -24.6 dBm driving the ADL6317 where the internal VVA is set to 0 dB, and the DSA is set to 0 dB attenuation. Figure 46 and Figure 47 show adjacent and alternate CPR performance vs. output power that is adjusted by VVA attenuation and by DSA attenuation, respectively, with -17.2 dBm of input power. Figure 45 to Figure 47 show below -65 dB adjacent and alternate CPR performance at below +10 dBm output power, and there is gradual degradation above +10 dBm from the contribution to the adjacent and alternate CPR performance of the second stage RF amplifier. When fixing the VVA attenuation and sweeping the DSA, the adjacent and alternate CPR performance remains constant below 6 dBm output power (see Figure 47).

Table 20. Power Optimization vs. Performance at 1850 MHz, VVA Attenuation= 0 dB, DSA Attenuation = 0 dB, TRM\_AMP2\_IP3 = 0x02

| TRM_AMPx_IREF_1 Setting (Decimal), Register 0x117 and Register 0x119, Bits[3:0] | DC Power (W) | Gain (dB) | OP1dB (dBm) | OIP3 (dBm) | NF (dB) |
|---|--------------|-----------|-------------|------------|---------|
| 3   | 2.36         | 33.1      | 25.8        | 40.3       | 6.6     |
| 2   | 2.10         | 33.1      | 25.6        | 40.3       | 5.9     |
| 1   | 1.84         | 33.1      | 25.1        | 39.2       | 5.8     |
| 0   | 1.55         | 32.8      | 24.3        | 36.9       | 5.8     |

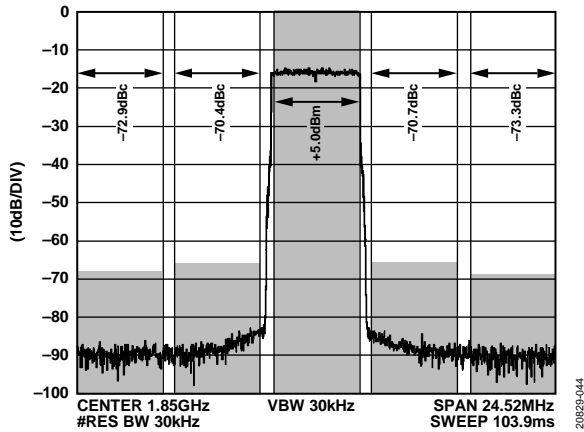

Figure 44. LTE Carrier, Adjacent and Alternate CPR at 1850 MHz, VVA Attenuation = 0 dB, DSA Attenuation = 11 dB,  $P_{IN} = -17.2$  dBm

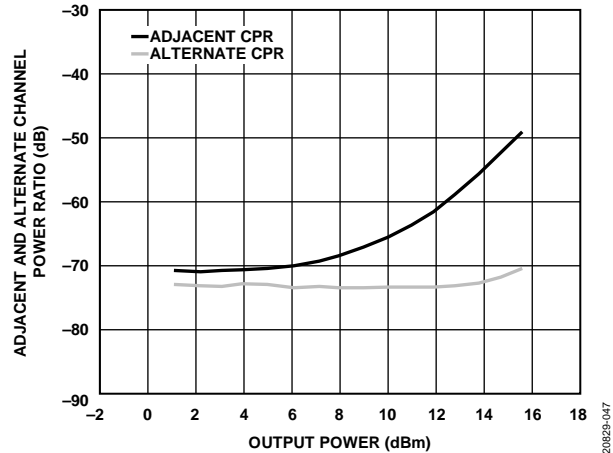

Figure 47. Adjacent and Alternate Channel Power Ratio vs. Output Power ( $P_{OUT}$ ) by DSA Attenuation at 1850 MHz, LTE TM1.1,  $P_{IN} = -17.2$  dBm, VVA Attenuation = 0 dB

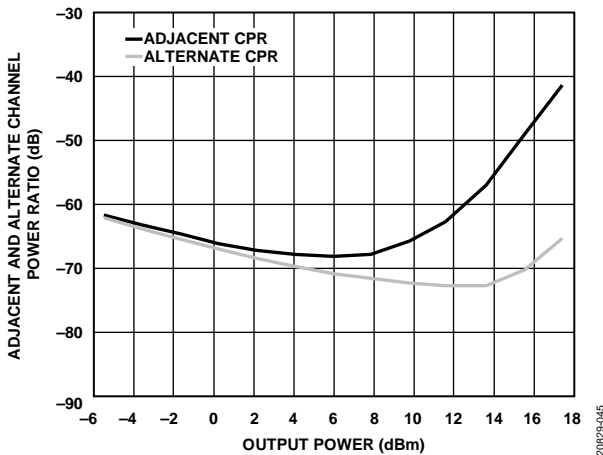

Figure 45. Adjacent and Alternate Channel Power Ratio vs. Output Power ( $P_{OUT}$ ) by  $P_{IN}$  at 1850 MHz, LTE Test Model 1.1 (TM1.1), VVA Attenuation = 0 dB, DSA Attenuation = 0 dB

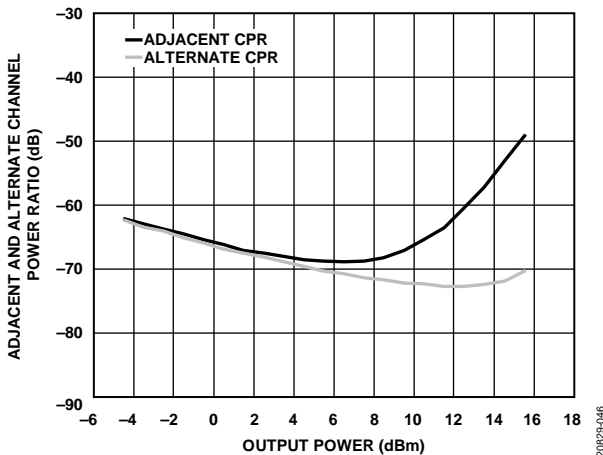

Figure 46. Adjacent and Alternate Channel Power Ratio vs. Output Power ( $P_{OUT}$ ) by VVA Attenuation at 1850 MHz, LTE TM1.1,  $P_{IN} = -17.2$  dBm, DSA Attenuation = 0 dB

### LAYOUT

Solder the exposed pad on the underside of the ADL6317 to a low thermal and electrical impedance ground plane. This pad is typically soldered to an exposed opening in the solder mask on the evaluation board. Notice the use of 19 via holes on the exposed pad of the ADL6317-EVALZ evaluation board. Connect these ground vias to all other ground layers on the evaluation board to maximize heat dissipation from the device package. For more information on the ADL6317-EVALZ evaluation board, contact Analog Devices, Inc.

Ensure that the decoupling capacitors are located close to the supply voltage pins.

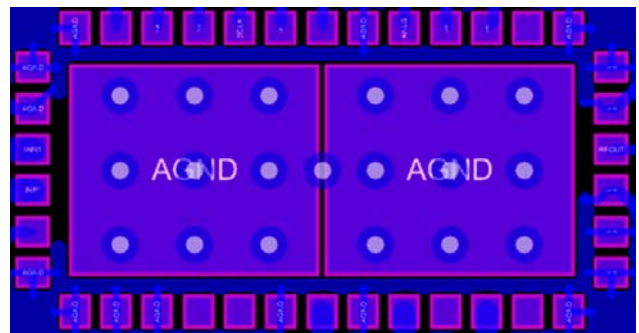
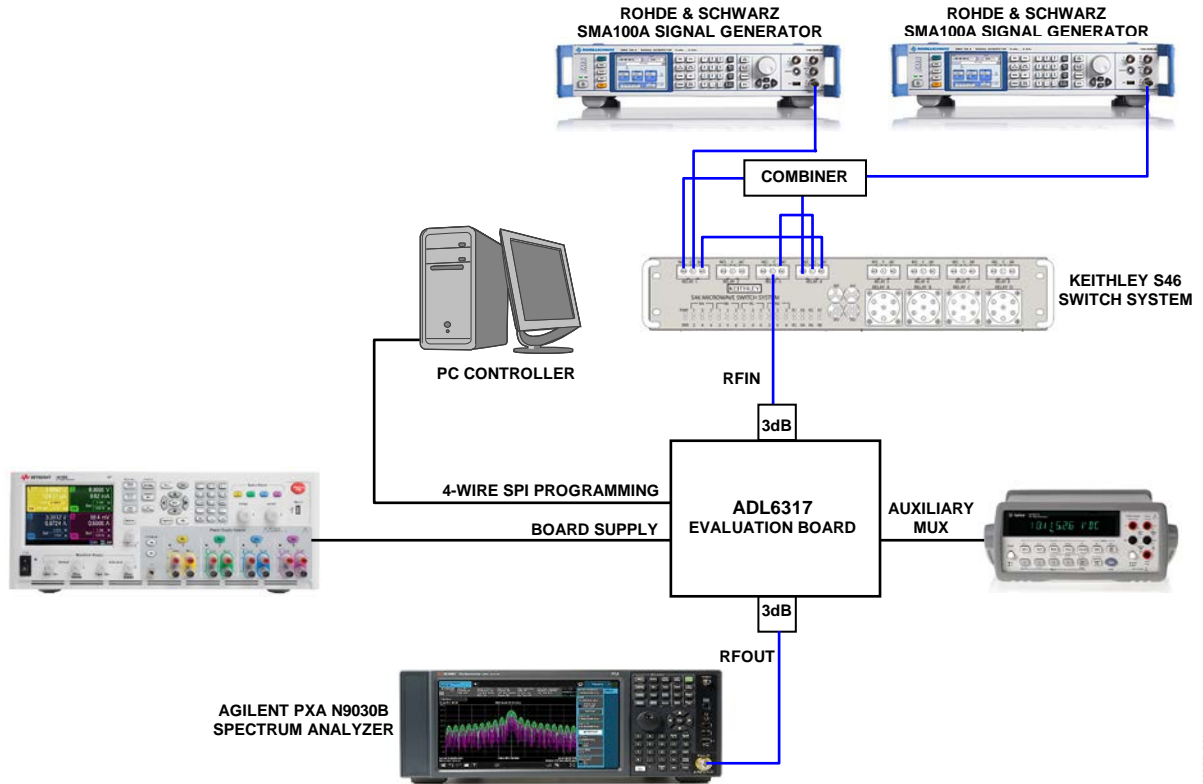

Figure 48. Evaluation Board Layout for the ADL6317-EVALZ

# CHARACTERIZATION SETUPS

The primary setup used to characterize the ADL6317 is shown in Figure 49. The setup measures gain, HD2, HD3, OIP2, and OIP3.



20829-049

Figure 49. General Characterization Setup

## REGISTER SUMMARY

Table 21. Register Summary

| Reg   | Name                 | Bits  | Bit 7                  | Bit 6      | Bit 5            | Bit 4               | Bit 3                | Bit 2        | Bit 1        | Bit 0                 | Reset                | RW   |     |     |
|-------|----------------------|-------|------------------------|------------|------------------|---------------------|----------------------|--------------|--------------|-----------------------|----------------------|------|-----|-----|
| 0x000 | ADL_SPI_CONFIG       | [7:0] | SOFTRESET_             | LSB_FIRST_ | ENDIAN_          | SDOACTIVE_          | SDOACTIVE_           | ENDIAN       | LSB_FIRST    | SOFTRESET             | 0x00                 | R/W  |     |     |
| 0x001 | REG_0X0001           | [7:0] | SINGLE_INSTRUCTION     | CSB_STALL  | MASTER_SLAVE_RB  | RESERVED            |                      | SOFT_RESET   |              | MASTER_SLAVE_TRANSFER | 0x00                 | R/W  |     |     |
| 0x003 | CHIPTYPE             | [7:0] | CHIPTYPE               |            |                  |                     |                      |              |              |                       |                      | 0x00 | R   |     |
| 0x004 | PRODUCT_ID_L         | [7:0] | PRODUCT_ID[7:0]        |            |                  |                     |                      |              |              |                       |                      | 0x00 | R   |     |
| 0x005 | PRODUCT_ID_H         | [7:0] | PRODUCT_ID[15:8]       |            |                  |                     |                      |              |              |                       |                      | 0x00 | R   |     |
| 0x00A | SCRATCHPAD           | [7:0] | SCRATCHPAD             |            |                  |                     |                      |              |              |                       |                      | 0x00 | R/W |     |
| 0x00B | SPI_REV              | [7:0] | SPI_REV                |            |                  |                     |                      |              |              |                       |                      | 0x00 | R   |     |
| 0x010 | VARIANT_FEOL         | [7:0] | FEOL                   |            |                  |                     | VARIANT              |              |              |                       |                      | 0x00 | R   |     |
| 0x011 | BEOL_SIF             | [7:0] | SIF                    |            |                  |                     | BEOL                 |              |              |                       |                      | 0x01 | R   |     |
| 0x012 | SPARE_012            | [7:0] | SPARE_012              |            |                  |                     |                      |              |              |                       |                      | 0x00 | R   |     |
| 0x013 | SPARE_013            | [7:0] | SPARE_013              |            |                  |                     |                      |              |              |                       |                      | 0x00 | R   |     |
| 0x100 | SIG_PATH0_0          | [7:0] | DAC_EN                 | AMUX_BG_EN | ADC_EN           | EN_IBIASGEN         | DSA_EN               | VVA_EN       | RESERVED     |                       |                      | 0x40 | R/W |     |
| 0x101 | SIG_PATH1_0          | [7:0] | RESERVED               |            |                  |                     |                      |              | IP3_OFF      | LDO33_EN              | 0x01                 |      |     | R/W |
| 0x102 | SIG_PATH2_0          | [7:0] | RESERVED               |            |                  | DSA_ATTEN_0         |                      |              |              |                       |                      | 0x3F | R/W |     |
| 0x103 | SIG_PATH3_0          | [7:0] | VVA_ATTEN[7:0]         |            |                  |                     |                      |              |              |                       |                      | 0x00 | R/W |     |
| 0x104 | SIG_PATH4_0          | [7:0] | RESERVED               |            |                  |                     | VVA_ATTEN[11:8]      |              |              |                       |                      | 0x00 | R/W |     |
| 0x105 | SIG_PATH5_0          | [7:0] | RESERVED               |            |                  |                     |                      |              | VVA_SRC      |                       |                      | 0x00 | R/W |     |
| 0x106 | SIG_PATH6_0          | [7:0] | RESERVED               |            |                  |                     |                      |              |              |                       | EN_IBIASGEN_RESISTOR | 0x00 | R/W |     |
| 0x107 | SIG_PATH7_0          | [7:0] | BYPASS_TRM_AMP1_IREF_0 | RESERVED   |                  | TRM_AMP1_IREF_SEL_0 | TRM_AMP1_IREF_0      |              |              |                       |                      | 0x00 | R/W |     |
| 0x108 | SIG_PATH8_0          | [7:0] | BYPASS_TRM_AMP1_EN_0   | RESERVED   |                  |                     |                      |              |              | AMP1_EN_0             | 0x00                 | R/W  |     |     |
| 0x109 | SIG_PATH9_0          | [7:0] | BYPASS_TRM_AMP2_IREF_0 | RESERVED   |                  | TRM_AMP2_IREF_SEL_0 | TRM_AMP2_IREF_0      |              |              |                       |                      | 0x00 | R/W |     |
| 0x10A | SIG_PATHA_0          | [7:0] | BYPASS_TRM_AMP2_EN_0   | RESERVED   |                  |                     |                      |              |              | AMP2_EN_0             | 0x00                 | R/W  |     |     |
| 0x10B | SIG_PATHB_0          | [7:0] | SPARE_10B              |            |                  |                     |                      |              | TRM_AMP2_CB  |                       |                      | 0x00 | R/W |     |
| 0x112 | SIG_PATH2_1          | [7:0] | RESERVED               |            |                  | DSA_ATTEN_1         |                      |              |              |                       |                      | 0x20 | R/W |     |
| 0x117 | SIG_PATH7_1          | [7:0] | BYPASS_TRM_AMP1_IREF_1 | RESERVED   |                  | TRM_AMP1_IREF_SEL_1 | TRM_AMP1_IREF_1      |              |              |                       |                      | 0x00 | R/W |     |
| 0x118 | SIG_PATH8_1          | [7:0] | BYPASS_TRM_AMP1_EN_1   | RESERVED   |                  |                     |                      |              |              | AMP1_EN_1             | 0x00                 | R/W  |     |     |
| 0x119 | SIG_PATH9_1          | [7:0] | BYPASS_TRM_AMP2_IREF_1 | RESERVED   |                  | TRM_AMP2_IREF_SEL_1 | TRM_AMP2_IREF_1      |              |              |                       |                      | 0x00 | R/W |     |
| 0x11A | SIG_PATHA_1          | [7:0] | BYPASS_TRM_AMP2_EN_1   | RESERVED   |                  |                     |                      |              |              | AMP2_EN_1             | 0x00                 | R/W  |     |     |
| 0x11B | SIG_PATHB_1          | [7:0] | SPARE_11B              |            |                  |                     |                      |              | TRM_AMP2_IP3 |                       |                      | 0x00 | R/W |     |
| 0x120 | AMUX_SEL             | [7:0] | RESERVED               | AMUX_3_SEL |                  |                     | AMUX_2_SEL           | AMUX_1_SEL   |              |                       |                      | 0x20 | R/W |     |
| 0x121 | MULTI_FUNC_CTRL_0111 | [7:0] | RESERVED               |            |                  | SPI_1P8_3P3_CTRL    | AMUX_EX              |              |              |                       |                      | 0x00 | R/W |     |
| 0x127 | ADC_CONTROL          | [7:0] | RESERVED               |            | ADC_CLOCK_DIV_EN | ADC_MUX_SEL         | RESERVED             | ADC_CLK_FREQ |              |                       |                      | 0x00 | R/W |     |
| 0x128 | ADC_EOC              | [7:0] | RESERVED               |            |                  |                     |                      |              |              |                       | ADC_EOC              | 0x00 | R   |     |
| 0x129 | ADC_OUT              | [7:0] | TEMP_ADC_OUT           |            |                  |                     |                      |              |              |                       |                      | 0x00 | R   |     |
| 0x146 | GENERIC_READBACK_2   | [7:0] | VVA_ATTEN_RDBK[7:0]    |            |                  |                     |                      |              |              |                       |                      | 0x00 | R   |     |
| 0x147 | GENERIC_READBACK_3   | [7:0] | RESERVED               |            |                  |                     | VVA_ATTEN_RDBK[11:8] |              |              |                       |                      | 0x00 | R   |     |
| 0x148 | GENERIC_READBACK_4   | [7:0] | RESERVED               |            |                  | DSA_ATTEN_RDBK      |                      |              |              |                       |                      | 0x00 | R   |     |



## REGISTER DETAILS

Address: 0x000, Reset: 0x00, Name: ADI\_SPI\_CONFIG

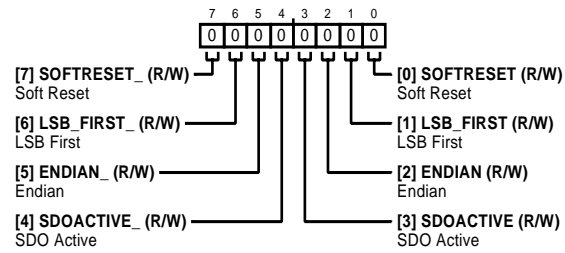

Table 22. Bit Descriptions for ADI\_SPI\_CONFIG

| Bits | Bit Name   | Description   | Reset | Access |
|------|------------|---|-------|--------|
| 7    | SOFTRESET_ | Soft Reset.<br>0: Reset not asserted.<br>1: Reset asserted. | 0x0   | R/W    |
| 6    | LSB_FIRST_ | LSB First.<br>0: MSB first.<br>1: LSB first.                | 0x0   | R/W    |
| 5    | ENDIAN_    | Endian.<br>0: Little endian.<br>1: Big endian.              | 0x0   | R/W    |
| 4    | SDOACTIVE_ | SDO Active.<br>0: SDO inactive.<br>1: SDO active.           | 0x0   | R/W    |
| 3    | SDOACTIVE  | SDO Active.<br>0: SDO inactive.<br>1: SDO active.           | 0x0   | R/W    |
| 2    | ENDIAN     | Endian.<br>0: Little endian.<br>1: Big endian.              | 0x0   | R/W    |
| 1    | LSB_FIRST  | LSB First.<br>0: MSB first.<br>1: LSB first.                | 0x0   | R/W    |
| 0    | SOFTRESET  | Soft Reset.<br>0: Reset not asserted.<br>1: Reset asserted. | 0x0   | R/W    |

Address: 0x001, Reset: 0x00, Name: REG\_0X0001

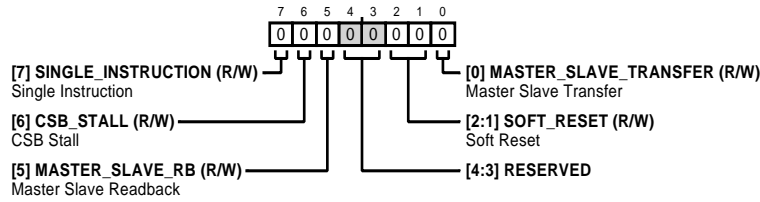

Table 23. Bit Descriptions for REG\_0X0001

| Bits  | Bit Name              | Description           | Reset | Access |
|-------|-----------------------|-----------------------|-------|--------|
| 7     | SINGLE_INSTRUCTION    | Single Instruction    | 0x0   | R/W    |
| 6     | CSB_STALL             | CS Stall              | 0x0   | R/W    |
| 5     | MASTER_SLAVE_RB       | Master Slave Readback | 0x0   | R/W    |
| [4:3] | RESERVED              | Reserved              | 0x0   | R      |
| [2:1] | SOFT_RESET            | Soft Reset            | 0x0   | R/W    |
| 0     | MASTER_SLAVE_TRANSFER | Master Slave Transfer | 0x0   | R/W    |

Address: 0x003, Reset: 0x00, Name: CHIPTYPE

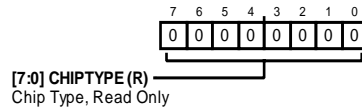

Table 24. Bit Descriptions for CHIPTYPE

| Bits  | Bit Name | Description          | Reset | Access |
|-------|----------|----------------------|-------|--------|
| [7:0] | CHIPTYPE | Chip Type, Read Only | 0x0   | R      |

Address: 0x004, Reset: 0x00, Name: PRODUCT\_ID\_L

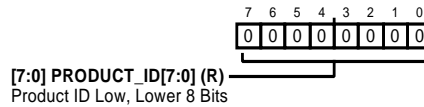

Table 25. Bit Descriptions for PRODUCT\_ID\_L

| Bits  | Bit Name        | Description                  | Reset | Access |
|-------|-----------------|------------------------------|-------|--------|
| [7:0] | PRODUCT_ID[7:0] | Product ID Low, Lower 8 Bits | 0x0   | R      |

Address: 0x005, Reset: 0x00, Name: PRODUCT\_ID\_H

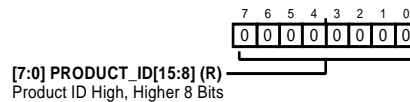

Table 26. Bit Descriptions for PRODUCT\_ID\_H

| Bits  | Bit Name         | Description                    | Reset | Access |
|-------|------------------|--------------------------------|-------|--------|
| [7:0] | PRODUCT_ID[15:8] | Product ID High, Higher 8 Bits | 0x0   | R      |

Address: 0x00A, Reset: 0x00, Name: SCRATCHPAD

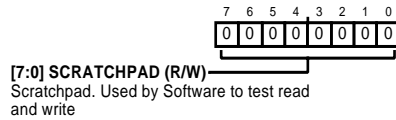

Table 27. Bit Descriptions for SCRATCHPAD

| Bits  | Bit Name   | Description  | Reset | Access |
|-------|------------|--|-------|--------|
| [7:0] | SCRATCHPAD | Scratchpad. Used by Software to test read and write. | 0x0   | R/W    |

Address: 0x00B, Reset: 0x00, Name: SPI\_REV

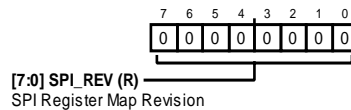

Table 28. Bit Descriptions for SPI\_REV

| Bits  | Bit Name | Description               | Reset | Access |
|-------|----------|---------------------------|-------|--------|
| [7:0] | SPI_REV  | SPI Register Map Revision | 0x0   | R      |

Address: 0x010, Reset: 0x00, Name: VARIANT\_FEOL

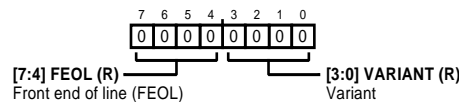

Table 29. Bit Descriptions for VARIANT\_FEOL

| Bits  | Bit Name | Description              | Reset | Access |
|-------|----------|--------------------------|-------|--------|
| [7:4] | FEOL     | Front end of line (FEOL) | 0x0   | R      |
| [3:0] | VARIANT  | Variant                  | 0x0   | R      |

Address: 0x011, Reset: 0x01, Name: BEOL\_SIF

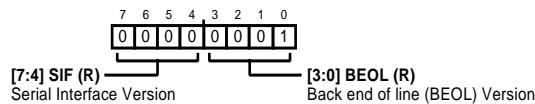

Table 30. Bit Descriptions for BEOL\_SIF

| Bits  | Bit Name | Description                     | Reset | Access |
|-------|----------|---------------------------------|-------|--------|
| [7:4] | SIF      | Serial Interface Version        | 0x0   | R      |
| [3:0] | BEOL     | Back end of line (BEOL) Version | 0x1   | R      |

Address: 0x012, Reset: 0x00, Name: SPARE\_0012

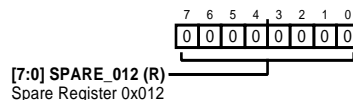

Table 31. Bit Descriptions for SPARE\_0012

| Bits  | Bit Name  | Description          | Reset | Access |
|-------|-----------|----------------------|-------|--------|
| [7:0] | SPARE_012 | Spare Register 0x012 | 0x0   | R      |

Address: 0x013, Reset: 0x00, Name: SPARE\_013

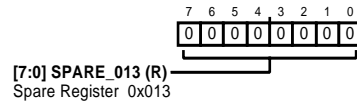

Table 32. Bit Descriptions for SPARE\_013

| Bits  | Bit Name  | Description          | Reset | Access |
|-------|-----------|----------------------|-------|--------|
| [7:0] | SPARE_013 | Spare Register 0x013 | 0x0   | R      |

Address: 0x100, Reset: 0x40, Name: SIG\_PATH0\_0

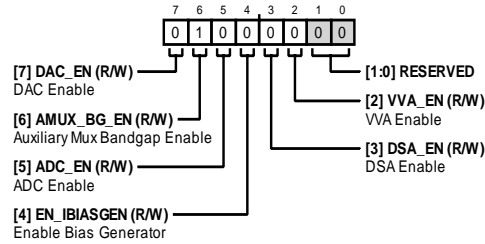

Table 33. Bit Descriptions for SIG\_PATH0\_0

| Bits  | Bit Name    | Description   | Reset | Access |
|-------|-------------|---|-------|--------|
| 7     | DAC_EN      | DAC Enable.<br>0: Disable DAC.<br>1: Enable DAC.  | 0x0   | R/W    |
| 6     | AMUX_BG_EN  | Auxiliary Mux Band Gap Enable.<br>0: Disable auxiliary mux band gap.<br>1: Enable auxiliary mux band gap. | 0x1   | R/W    |
| 5     | ADC_EN      | ADC Enable.<br>0: Disable ADC.<br>1: Enable ADC.  | 0x0   | R/W    |
| 4     | EN_IBIASGEN | Enable Bias Generator.<br>0: Disable bias generator.<br>1: Enable bias generator.                         | 0x0   | R/W    |
| 3     | DSA_EN      | DSA Enable.<br>0: Disable DSA.<br>1: Enable DSA.  | 0x0   | R/W    |
| 2     | VVA_EN      | VVA Enable.<br>0: Disable VVA.<br>1: Enable VVA.  | 0x0   | R/W    |
| [1:0] | RESERVED    | Reserved.   | 0x0   | R      |

Address: 0x101, Reset: 0x01, Name: SIG\_PATH1\_0

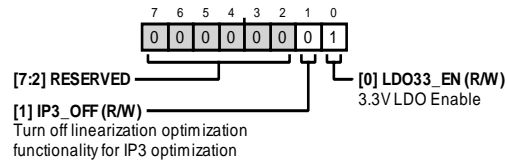

Table 34. Bit Descriptions for SIG\_PATH1\_0

| Bits  | Bit Name | Description  | Reset | Access |
|-------|----------|--|-------|--------|
| [7:2] | RESERVED | Reserved.  | 0x0   | R      |
| 1     | IP3_OFF  | Turn off linearization optimization functionality for IP3 optimization.<br>0: Turn on linearization optimization functionality.<br>1: Turn off linearization optimization functionality. | 0x0   | R/W    |
| 0     | LDO33_EN | 3.3 V LDO Enable.<br>0: Disable 3.3 V LDO.<br>1: Enable 3.3 V LDO.   | 0x1   | R/W    |

Address: 0x102, Reset: 0x3F, Name: SIG\_PATH2\_0

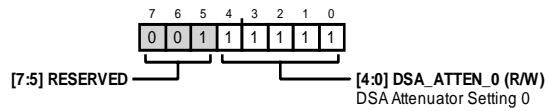

Table 35. Bit Descriptions for SIG\_PATH2\_0

| Bits  | Bit Name    | Description   | Reset | Access |
|-------|-------------|---|-------|--------|
| [7:5] | RESERVED    | Reserved.   | 0x1   | R      |
| [4:0] | DSA_ATTEN_0 | DSA Attenuator Setting 0.<br>0: 0 dB.<br>1: 0.5 dB.<br>10: 1 dB.<br>11: 1.5 dB.<br>100: 2 dB.<br>101: 2.5 dB.<br>110: 3 dB.<br>111: 3.5 dB.<br>1000: 4 dB.<br>1001: 4.5 dB.<br>1010: 5 dB.<br>1011: 5.5 dB.<br>1100: 6 dB.<br>1101: 6.5 dB.<br>1110: 7 dB.<br>1111: 7.5 dB.<br>10000: 8 dB.<br>10001: 8.5 dB.<br>10010: 9 dB.<br>10011: 9.5 dB.<br>10100: 10 dB.<br>10101: 10.5 dB.<br>10110: 11 dB.<br>10111: 11.5 dB. | 0x1F  | R/W    |

| Bits | Bit Name | Description  | Reset | Access |
|------|----------|--|-------|--------|
|      |          | 11000: 12 dB.<br>11001: 12.5 dB.<br>11010: 13 dB.<br>11011: 13.5 dB.<br>11100: 14 dB.<br>11101: 14.5 dB.<br>11110: 15 dB.<br>11111: 15.5 dB. |       |        |

Address: 0x103, Reset: 0x00, Name: SIG\_PATH3\_0

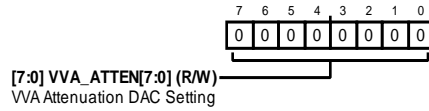

Table 36. Bit Descriptions for SIG\_PATH3\_0

| Bits  | Bit Name       | Description                 | Reset | Access |
|-------|----------------|-----------------------------|-------|--------|
| [7:0] | VVA_ATTEN[7:0] | VVA Attenuation DAC Setting | 0x0   | R/W    |

Address: 0x104, Reset: 0x00, Name: SIG\_PATH4\_0

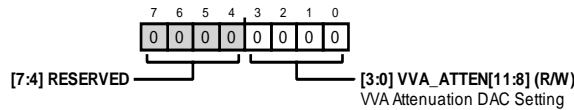

Table 37. Bit Descriptions for SIG\_PATH4\_0

| Bits  | Bit Name        | Description                 | Reset | Access |
|-------|-----------------|-----------------------------|-------|--------|
| [7:4] | RESERVED        | Reserved                    | 0x0   | R      |
| [3:0] | VVA_ATTEN[11:8] | VVA Attenuation DAC Setting | 0x0   | R/W    |

Address: 0x105, Reset: 0x00, Name: SIG\_PATH5\_0

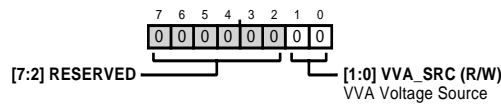

Table 38. Bit Descriptions for SIG\_PATH5\_0

| Bits  | Bit Name | Description   | Reset | Access |
|-------|----------|---|-------|--------|
| [7:2] | RESERVED | Reserved  | 0x0   | R      |
| [1:0] | VVA_SRC  | VVA Voltage Source<br>00: DAC to VVA<br>10: Pin 30 to VVA | 0x0   | R/W    |

Address: 0x106, Reset: 0x00, Name: SIG\_PATH6\_0

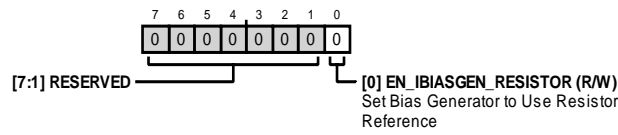

Table 39. Bit Descriptions for SIG\_PATH6\_0

| Bits  | Bit Name             | Description   | Reset | Access |
|-------|----------------------|---|-------|--------|
| [7:1] | RESERVED             | Reserved  | 0x0   | R      |
| 0     | EN_IBIASGEN_RESISTOR | Set Bias Generator to Use Resistor Reference<br>0: Disable I <sub>BIAS</sub><br>1: Enable I <sub>BIAS</sub> | 0x0   | R/W    |

Address: 0x107, Reset: 0x00, Name: SIG\_PATH7\_0

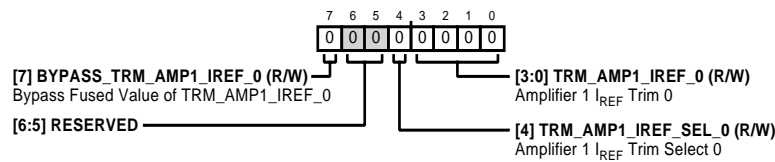

Table 40. Bit Descriptions for SIG\_PATH7\_0

| Bits  | Bit Name               | Description                                | Reset | Access |
|-------|------------------------|--|-------|--------|
| 7     | BYPASS_TRM_AMP1_IREF_0 | Bypass Fused Value of TRM_AMP1_IREF_0      | 0x0   | R/W    |
| [6:5] | RESERVED               | Reserved                                   | 0x0   | R      |
| 4     | TRM_AMP1_IREF_SEL_0    | Amplifier 1 I <sub>REF</sub> Trim Select 0 | 0x0   | R/W    |
| [3:0] | TRM_AMP1_IREF_0        | Amplifier 1 I <sub>REF</sub> Trim 0        | 0x0   | R/W    |

Address: 0x108, Reset: 0x00, Name: SIG\_PATH8\_0

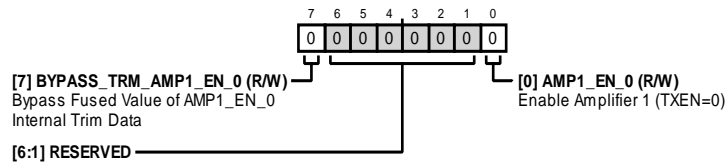

Table 41. Bit Descriptions for SIG\_PATH8\_0

| Bits  | Bit Name             | Description  | Reset | Access |
|-------|----------------------|--|-------|--------|
| 7     | BYPASS_TRM_AMP1_EN_0 | Bypass Fused Value of AMP1_EN_0 Internal Trim Data | 0x0   | R/W    |
| [6:1] | RESERVED             | Reserved   | 0x0   | R      |
| 0     | AMP1_EN_0            | Enable Amplifier 1 (TXEN = 0)                      | 0x0   | R/W    |

Address: 0x109, Reset: 0x00, Name: SIG\_PATH9\_0

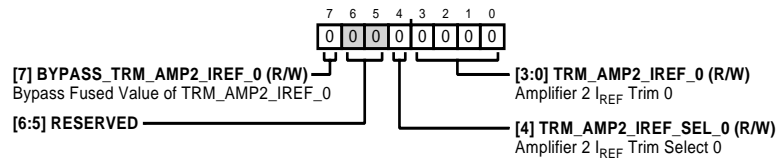

Table 42. Bit Descriptions for SIG\_PATH9\_0

| Bits  | Bit Name               | Description                                | Reset | Access |
|-------|------------------------|--|-------|--------|
| 7     | BYPASS_TRM_AMP2_IREF_0 | Bypass Fused Value of TRM_AMP2_IREF_0      | 0x0   | R/W    |
| [6:5] | RESERVED               | Reserved                                   | 0x0   | R      |
| 4     | TRM_AMP2_IREF_SEL_0    | Amplifier 2 I <sub>REF</sub> Trim Select 0 | 0x0   | R/W    |
| [3:0] | TRM_AMP2_IREF_0        | Amplifier 2 I <sub>REF</sub> Trim 0        | 0x0   | R/W    |

Address: 0x10A, Reset: 0x00, Name: SIG\_PATHA\_0

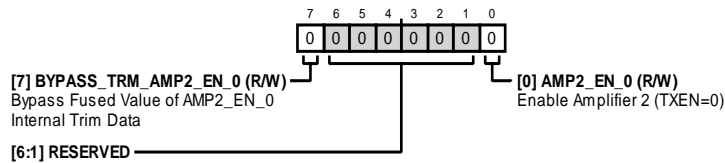

Table 43. Bit Descriptions for SIG\_PATHA\_0

| Bits  | Bit Name             | Description  | Reset | Access |
|-------|----------------------|--|-------|--------|
| 7     | BYPASS_TRM_AMP2_EN_0 | Bypass Fused Value of AMP2_EN_0 Internal Trim Data | 0x0   | R/W    |
| [6:1] | RESERVED             | Reserved   | 0x0   | R      |
| 0     | AMP2_EN_0            | Enable Amplifier 2 (TXEN = 0)                      | 0x0   | R/W    |

Address: 0x10B, Reset: 0x00, Name: SIG\_PATHB\_0

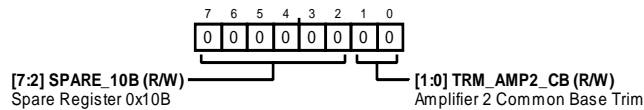

Table 44. Bit Descriptions for SIG\_PATHB\_0

| Bits  | Bit Name    | Description                  | Reset | Access |
|-------|-------------|------------------------------|-------|--------|
| [7:2] | SPARE_10B   | Spare Register 0x10B         | 0x0   | R/W    |
| [1:0] | TRM_AMP2_CB | Amplifier 2 Common Base Trim | 0x0   | R/W    |





Address: 0x117, Reset: 0x00, Name: SIG\_PATH7\_1

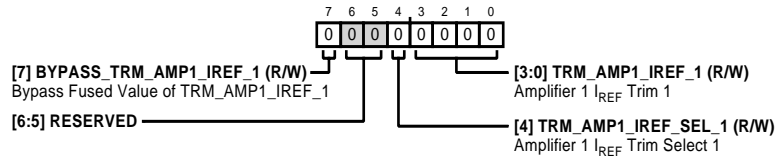

Table 46. Bit Descriptions for SIG\_PATH7\_1

| Bits  | Bit Name               | Description                                | Reset | Access |
|-------|------------------------|--|-------|--------|
| 7     | BYPASS_TRM_AMP1_IREF_1 | Bypass Fused Value of TRM_AMP1_IREF_1      | 0x0   | R/W    |
| [6:5] | RESERVED               | Reserved                                   | 0x0   | R      |
| 4     | TRM_AMP1_IREF_SEL_1    | Amplifier 1 I <sub>REF</sub> Trim Select 1 | 0x0   | R/W    |
| [3:0] | TRM_AMP1_IREF_1        | Amplifier 1 I <sub>REF</sub> Trim 1        | 0x0   | R/W    |

Address: 0x118, Reset: 0x00, Name: SIG\_PATH8\_1

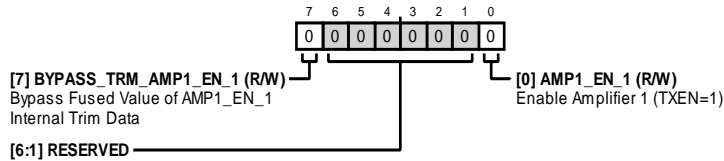

Table 47. Bit Descriptions for SIG\_PATH8\_1

| Bits  | Bit Name             | Description  | Reset | Access |
|-------|----------------------|--|-------|--------|
| 7     | BYPASS_TRM_AMP1_EN_1 | Bypass Fused Value of AMP1_EN_1 Internal Trim Data | 0x0   | R/W    |
| [6:1] | RESERVED             | Reserved   | 0x0   | R      |
| 0     | AMP1_EN_1            | Enable Amplifier 1 (TXEN = 1)                      | 0x0   | R/W    |

Address: 0x119, Reset: 0x00, Name: SIG\_PATH9\_1

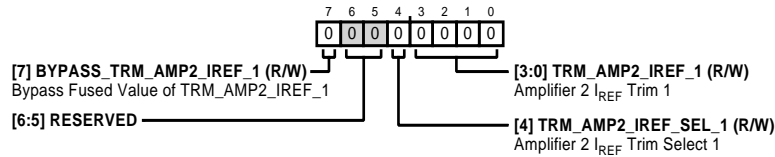

Table 48. Bit Descriptions for SIG\_PATH9\_1

| Bits  | Bit Name               | Description                                | Reset | Access |
|-------|------------------------|--|-------|--------|
| 7     | BYPASS_TRM_AMP2_IREF_1 | Bypass Fused Value of TRM_AMP2_IREF_1      | 0x0   | R/W    |
| [6:5] | RESERVED               | Reserved                                   | 0x0   | R      |
| 4     | TRM_AMP2_IREF_SEL_1    | Amplifier 2 I <sub>REF</sub> Trim Select 1 | 0x0   | R/W    |
| [3:0] | TRM_AMP2_IREF_1        | Amplifier 2 I <sub>REF</sub> Trim 1        | 0x0   | R/W    |

Address: 0x11A, Reset: 0x00, Name: SIG\_PATHA\_1

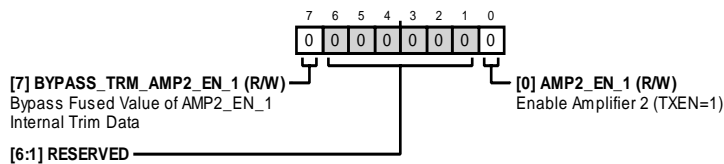

Table 49. Bit Descriptions for SIG\_PATHA\_1

| Bits  | Bit Name             | Description  | Reset | Access |
|-------|----------------------|--|-------|--------|
| 7     | BYPASS_TRM_AMP2_EN_1 | Bypass Fused Value of AMP2_EN_1 Internal Trim Data | 0x0   | R/W    |
| [6:1] | RESERVED             | Reserved   | 0x0   | R      |
| 0     | AMP2_EN_1            | Enable Amplifier 2 (TXEN = 1)                      | 0x0   | R/W    |

Address: 0x11B, Reset: 0x00, Name: SIG\_PATHB\_1

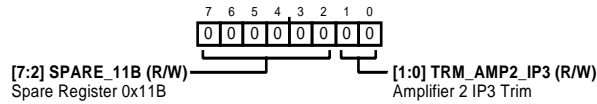

Table 50. Bit Descriptions for SIG\_PATHB\_1

| Bits  | Bit Name     | Description  | Reset | Access |
|-------|--------------|--|-------|--------|
| [7:2] | SPARE_11B    | Spare Register 0x11B   | 0x0   | R/W    |
| [1:0] | TRM_AMP2_IP3 | Amplifier 2 IP3 Trim<br>00: Trim Mode 0<br>01: Trim Mode 1<br>10: Trim Mode 2<br>11: Trim Mode 3 | 0x0   | R/W    |

Address: 0x120, Reset: 0x20, Name: AMUX\_SEL

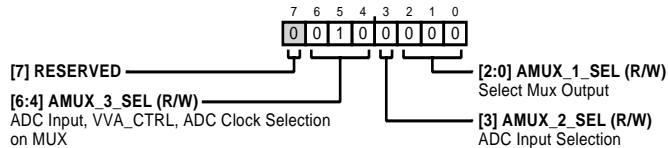

Table 51. Bit Descriptions for AMUX\_SEL

| Bits  | Bit Name   | Description  | Reset | Access |
|-------|------------|--|-------|--------|
| 7     | RESERVED   | Reserved.  | 0x0   | R/W    |
| [6:4] | AMUX_3_SEL | ADC Input, VVA_CTRL, ADC Clock Selection on Mux.<br>000: VVA_CTRL.<br>001: ADC input.<br>010: ADC clock.<br>011 to 111: Not used.  | 0x2   | R/W    |
| 3     | AMUX_2_SEL | ADC Input Selection.<br>0: PTAT to ADC input.<br>1: VVA_CTRL to ADC input.   | 0x0   | R/W    |
| [2:0] | AMUX_1_SEL | Select Mux Output.<br>000: PTAT.<br>001: Output of AMUX_3_SEL.<br>010: 1.8 V LDO output.<br>011: 3.3 V LDO output.<br>100: GND.<br>101: GND.<br>110: Not used.<br>111: Not used. | 0x0   | R/W    |

Address: 0x121, Reset: 0x00, Name: MULTI\_FUNC\_CTRL\_0111

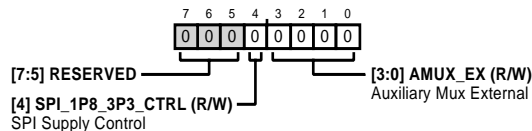

Table 52. Bit Descriptions for MULTI\_FUNC\_CTRL\_0111

| Bits  | Bit Name         | Description  | Reset | Access |
|-------|------------------|--|-------|--------|
| [7:5] | RESERVED         | Reserved   | 0x0   | R      |
| 4     | SPI_1P8_3P3_CTRL | SPI Supply Control<br>0: 1.8 V readback<br>1: 3.3 V readback | 0x0   | R/W    |
| [3:0] | AMUX_EX          | Auxiliary Mux External                                       | 0x0   | R/W    |

Address: 0x127, Reset: 0x00, Name: ADC\_CONTROL

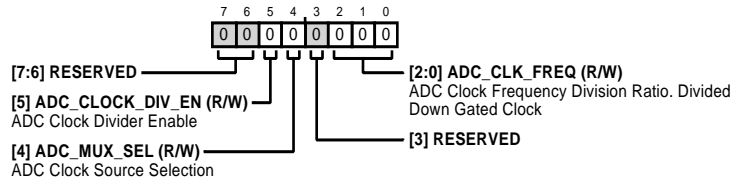

Table 53. Bit Descriptions for ADC\_CONTROL

| Bits  | Bit Name         | Description   | Reset | Access |
|-------|------------------|---|-------|--------|
| [7:6] | RESERVED         | Reserved.   | 0x0   | R      |
| 5     | ADC_CLOCK_DIV_EN | ADC Clock Divider Enable.<br>0: Disable ADC clock divider.<br>1: Enable ADC clock divider.  | 0x0   | R/W    |
| 4     | ADC_MUX_SEL      | ADC Clock Source Selection.<br>0: ADC clock from SCLK.<br>1: Not used.  | 0x0   | R/W    |
| 3     | RESERVED         | Reserved.   | 0x0   | R      |
| [2:0] | ADC_CLK_FREQ     | ADC Clock Frequency Division Ratio. Divided Down Gated Clock.<br>000: ADC clock at SCLK/2.<br>001: ADC clock at SCLK/1.<br>010: ADC clock at SCLK/2.<br>011: ADC clock at SCLK/4. | 0x0   | R/W    |

Address: 0x128, Reset: 0x00, Name: ADC\_EOC

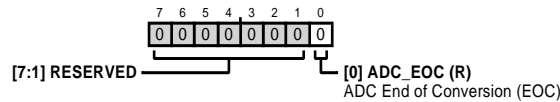

Table 54. Bit Descriptions for ADC\_EOC

| Bits  | Bit Name | Description                 | Reset | Access |
|-------|----------|-----------------------------|-------|--------|
| [7:1] | RESERVED | Reserved                    | 0x0   | R      |
| 0     | ADC_EOC  | ADC End of Conversion (EOC) | 0x0   | R      |

Address: 0x129, Reset: 0x00, Name: ADC\_OUT

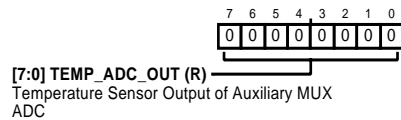

Table 55. Bit Descriptions for ADC\_OUT

| Bits  | Bit Name     | Description                                    | Reset | Access |
|-------|--------------|--|-------|--------|
| [7:0] | TEMP_ADC_OUT | Temperature Sensor Output of Auxiliary Mux ADC | 0x0   | R      |

Address: 0x146, Reset: 0x00, Name: GENERIC\_READBACK\_2

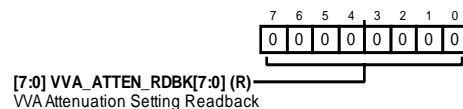

Table 56. Bit Descriptions for GENERIC\_READBACK\_2

| Bits  | Bit Name            | Description                      | Reset | Access |
|-------|---------------------|----------------------------------|-------|--------|
| [7:0] | VVA_ATTEN_RDBK[7:0] | VVA Attenuation Setting Readback | 0x0   | R      |

Address: 0x147, Reset: 0x00, Name: GENERIC\_READBACK\_3

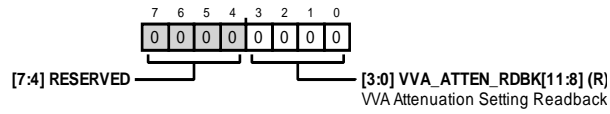

Table 57. Bit Descriptions for GENERIC\_READBACK\_3

| Bits  | Bit Name             | Description                      | Reset | Access |
|-------|----------------------|----------------------------------|-------|--------|
| [7:4] | RESERVED             | Reserved                         | 0x0   | R      |
| [3:0] | VVA_ATTEN_RDBK[11:8] | VVA Attenuation Setting Readback | 0x0   | R      |

Address: 0x148, Reset: 0x00, Name: GENERIC\_READBACK\_4

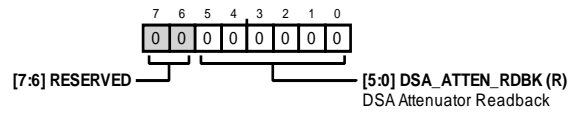

Table 58. Bit Descriptions for GENERIC\_READBACK\_4

| Bits  | Bit Name       | Description             | Reset | Access |
|-------|----------------|-------------------------|-------|--------|
| [7:6] | RESERVED       | Reserved                | 0x0   | R      |
| [5:0] | DSA_ATTEN_RDBK | DSA Attenuator Readback | 0x0   | R      |