

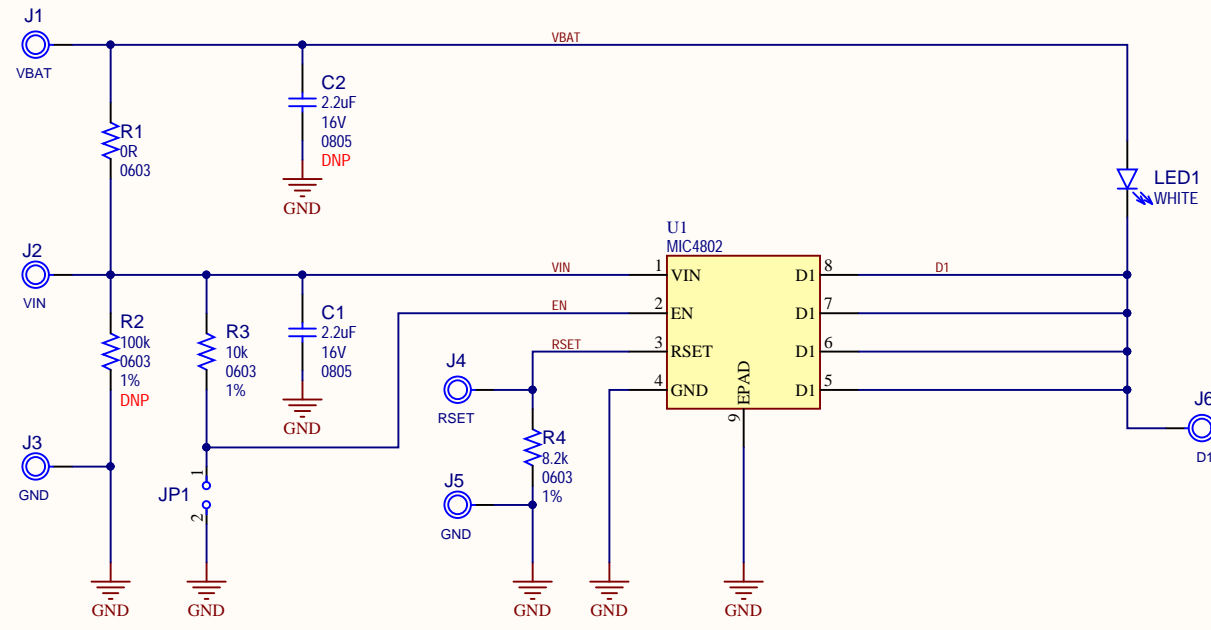





REV	ECO#	DESCRIPTION	DATE



LABEL1  
**02- -R1**  
**JIT**  
 LABEL Need Help Small

- PAD1  
  
 Rubber Pad Cyl D7.9H5.3
- PAD2  
  
 Rubber Pad Cyl D7.9H5.3
- PAD3  
  
 Rubber Pad Cyl D7.9H5.3
- PAD4  
  
 Rubber Pad Cyl D7.9H5.3

Drawn By: Razvan Costache		
Engineer: Razvan Costache		
PartNumber: ADM00942	Project Title <b>MIC4802YME LED Driver Evaluation Board</b>	
Sheet Title <b>MIC4802YME LED Driver Evaluation Board</b>		 <i>Designed with</i> <b>Altium</b> <a href="http://Altium.com">Altium.com</a>
Size B	Sch #03-10835 Revision:2	Date: 4/23/2018 5:22:45 PM Sheet 1 of 1
File: Mechanical.SchDoc		