

FEATURES

- Monitor current and two voltages
- High accuracy current monitoring at low sense voltage
 - 0.33% accurate at ± 20 mV sense voltage over temperature
- Common-mode sense voltage from 0 V to 20 V ([ADM1293](#))
- Support high-side and low-side current sensing
- Integrated shunt regulator for wide supply input ([ADM1294](#))
- Reports current, voltage, and power
- Power accumulation for energy metering
- Bidirectional current sensing
- Digitally programmable overcurrent alert
- Multifunctional pins with user configurable functions
 - ADC conversion enable input
 - Multisource alert output
 - User-controllable GPO
- Peak detect registers for current, voltage, and power
- PMBus fast mode compliant interface
- Separate SDA I/O for easy isolated communication
- Two address pins for 16 unique I²C addresses
- Available in 4 mm × 4 mm, 16-lead LFCSP and 14-lead TSSOP
- Operation temperature range
 - [ADM1293](#) T_A = -40°C to +105°C
 - [ADM1294](#) T_J = -40°C to +105°C

APPLICATIONS

- Power monitoring/power budgeting
- Central office equipment
- Telecommunications and data communications equipment
- PCs/servers

GENERAL DESCRIPTION

The [ADM1293](#) and [ADM1294](#) are high accuracy integrated digital power monitors that offer digital current, voltage, and power monitoring using an on-chip, 12-bit analog-to-digital converter (ADC), communicated through a PMBus™ compliant I²C interface.

These devices acquire the current by measuring the voltage difference across the external sense resistor. This voltage is amplified and digitized by an internal 12-bit ADC. The same ADC can also sample the primary input voltage and an auxiliary input voltage. The internal digital block can perform multiplication of the current and primary input voltage for power calculation. The [ADM1293/ADM1294](#) also feature a power accumulator for energy metering. An industry-standard PMBus interface allows a master controller to read back these data from the device. The master controller can then combine this information with a known sense resistor value to calculate the current, voltage, power, and energy consumption over time on the monitored rail.

Rev. B

Document Feedback

Information furnished by Analog Devices is believed to be accurate and reliable. However, no responsibility is assumed by Analog Devices for its use, nor for any infringements of patents or other rights of third parties that may result from its use. Specifications subject to change without notice. No license is granted by implication or otherwise under any patent or patent rights of Analog Devices. Trademarks and registered trademarks are the property of their respective owners.

FUNCTIONAL BLOCK DIAGRAMS

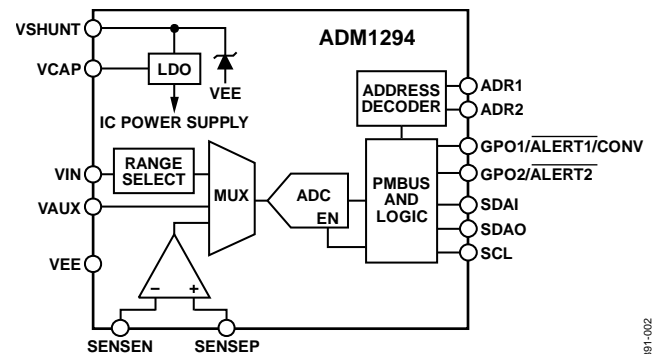
 Figure 1. [ADM1293](#) Functional Block Diagram

 Figure 2. [ADM1294](#) Functional Block Diagram

In conditions such as overcurrent, overvoltage, undervoltage, and overpower, the [ADM1293/ADM1294](#) devices can generate an interrupt signal to the microprocessor through the GPOx/ALERTx outputs. The threshold for these conditions is digitally programmed via PMBus.

The [ADM1293](#) is designed for high-side supply monitoring with a voltage monitoring range from 0 V to 20 V. The [ADM1294](#) is designed for low-side supply monitoring. Its integrated shunt regulator allows it to be powered and to monitor supply in wide voltage ranges.

The [ADM1293/ADM1294](#) are available in 4 mm × 4 mm 16-lead LFCSP and 14-lead TSSOP packages with a specified operating ambient temperature range from -40°C to +105°C for the [ADM1293](#) and an operating junction temperature range from -40°C to +105°C for the [ADM1294](#).

TABLE OF CONTENTS

Features	1	Digital Comparator Mode.....	29
Applications.....	1	Application Diagrams.....	30
Functional Block Diagrams.....	1	PMBus Command Reference.....	32
General Description	1	PMBus Command Descriptions	33
Revision History	3	Clear Faults Register	33
Specifications.....	4	PMBus Capability Register	33
Electrical Characteristics	4	IOUT OC Warning Limit Register	33
Serial Bus Timing Characteristics	7	VIN OV Warning Limit Register	33
Absolute Maximum Ratings.....	8	VIN UV Warning Limit Register	34
Thermal Characteristics	8	PIN OP Warning Limit Register	34
ESD Caution.....	8	Status Byte Register.....	34
Pin Configurations and Function Descriptions	9	Status Word Register	34
Typical Performance Characteristics	11	IOUT Status Register	35
Theory of Operation	14	Input Status Register	35
Powering the ADM1293.....	14	Manufacturer Specific Status Register.....	36
Powering the ADM1294.....	14	Read EIN Register	36
Optional Power Monitor Inputs Filtering.....	16	Read EOUT Register.....	37
Power Monitor	16	Read VIN Register.....	37
PMBus Interface	18	Read IOUT Register.....	37
Device Addressing.....	18	Read PIN Register	37
SMBus Protocol Usage.....	19	PMBus Revision Register	38
Packet Error Checking.....	19	Manufacturer ID Register	38
Partial Transactions on I ² C Bus	19	Manufacturer Model Register.....	38
SMBus Message Formats	19	Manufacturer Revision Register.....	38
Group Commands.....	21	Maximum IOUT Register	38
Information Commands.....	21	Peak VIN Register	39
Status Commands.....	21	Peak VAUX Register	39
GPOx and ALERTx Pin Setup Commands	22	Power Monitor Control Register.....	39
Power Monitor Commands	22	Power Monitor Configuration Register.....	40
Warning Limit Setup Commands	24	Alert 1 Configuration Register	41
PMBus Direct Format Conversion	24	Alert 2 Configuration Register	41
Energy Meter Value Conversion	26	Device Configuration Register	42
Energy Meter Value to PMBus Standard Data Conversion..	27	Maximum PIN Register.....	42
Voltage and Current Conversion Using LSB Values.....	27	Read PIN (Extended) Register	43
ALERTx Pin Behavior.....	28	Read EIN (Extended) Register	43
Warnings.....	28	Read VAUX Register	43
Generating an Alert.....	28	VAUX OV Warning Limit Register	43
Handling/Clearing an Alert	28	VAUX UV Warning Limit Register	44
SMBus Alert Response Address (ARA)	28	Minimum IOUT Register.....	44
Example Use of SMBus ARA	29	Minimum PIN Register.....	44

Read EOUT (Extended) Register44
 Hysteresis Low Threshold Level Register45
 Hysteresis High Threshold Level Register45

Hysteresis Status Register.....45
 Outline Dimensions.....46
 Ordering Guide47

REVISION HISTORY

3/15—Rev. A to Rev. B

Changes to Power Monitor Section16
 Added Table 717
 Changes to Energy Meter Value Conversion Section.....26
 Changes to Table 2336
 Changes to Table 2437
 Changes to Table 4243
 Changes to Table 4844
 Changes to Ordering Guide.....47

10/14—Rev. 0 to Rev. A

Changes to Figure 1914
 Added Table 7; Renumbered Sequentially20

8/14—Revision 0: Initial Version

SPECIFICATIONS

ELECTRICAL CHARACTERISTICS

For the **ADM1293**: $V_{CC} = 2.95\text{ V to }20\text{ V}$, $V_{SENSEP} = 0\text{ V to }20\text{ V}$, $V_{CC} \geq V_{SENSEP}$, $V_{CC} \geq V_{SENSEN}$, $T_A = -40^\circ\text{C to }+105^\circ\text{C}$, unless otherwise noted.
 For the **ADM1294**: $V_{EE} = -48\text{ V}$, shunt regulation current = 10 mA, $V_{SENSEP} = V_{EE} = 0\text{ V}$, pin voltages are referenced to the VEE pin, $T_J = -40^\circ\text{C to }+105^\circ\text{C}$, unless otherwise noted. All minimum/maximum specifications apply over the entire recommended operating range, unless otherwise noted. Typical values are specified at $T_A = 25^\circ\text{C}$.

Table 1.

Parameter	Symbol	Min	Typ	Max	Unit	Test Conditions/Comments
POWER SUPPLY						
ADM1293						
Operating Voltage Range	V_{OP3}	2.95		20	V	VCC rising
Undervoltage Lockout (UVLO)	V_{UVLO_3}	2.4		2.7	V	
UVLO Hysteresis			90	120	mV	
Quiescent Current	I_{CC3}			3.3	mA	
ADM1294						
Typical Operating Voltage	V_{OP4}	2.95		V_{SHUNT}	V	Reference to VEE
Voltage Transient Immunity			200		V	
Shunt Regulation Voltage	V_{SHUNT}	11.5	12.3	13	V	$I_{IN} = 3.3\text{ mA to }30\text{ mA}$, maximum I_{IN} dependent on T_A and θ_{JA} (see the Powering the ADM1294 section)
Undervoltage Lockout	V_{UVLO_4}	2.4		2.7	V	V_{SHUNT} rising
UVLO Hysteresis			90	120	mV	
Quiescent Current	I_{CC4}			3.6	mA	$V_{SHUNT} = 13\text{ V}$
Power Directly Without Shunt	V_{DIR}	2.95		11.5	V	
SENSE AND SENSEN PINS						
ADM1293						
Input Current	I_{IN_SENSE3}			± 25	nA	Per individual pin, $V_{SENSEP} = V_{SENSEN} = V_{CC} = 20\text{ V}$
Input Imbalance	$I_{\Delta SENSE3}$		± 5	± 25	nA	$I_{\Delta SENSEX} = I_{SENSEP} - I_{SENSEN}$, $V_{SENSE} = \pm 20\text{ mV}$, $V_{SENSEP} = V_{SHUNT}$
ADM1294						
Input Current	I_{IN_SENSE4}			-1	μA	$V_{SENSEP} = V_{SENSEN} \leq 25\text{ mV}$, per individual pin, $V_{VSHUNT} = 12\text{ V}$
Input Imbalance	$I_{\Delta SENSE4}$		± 0.05	± 1	μA	$I_{\Delta SENSEX} = I_{SENSEP} - I_{SENSEN}$, $V_{SENSE} = \pm 20\text{ mV}$, $V_{SENSEP} = 0\text{ V}$, $V_{VSHUNT} = 12\text{ V}$
VCAP PIN						
Internally Regulated Voltage	V_{VCAP}	2.66	2.7	2.74	V	$0\text{ }\mu\text{A} \leq I_{VCAP} \leq 100\text{ }\mu\text{A}$, $C_{VCAP} = 1\text{ }\mu\text{F}$
VIN PIN						
Input Current	I_{VIN}			20	μA	$V_{VIN} = 20\text{ V}$, $V_{RANGE} = 0\text{ V to }21\text{ V}$
				± 100	nA	$V_{VIN} = 1.2\text{ V}$, $V_{RANGE} = 0\text{ V to }1.2\text{ V}$
VAUX PIN						
Input Current	I_{VAUX}			± 100	nA	$V_{VAUX} = 1.2\text{ V}$, VAUX sampling enabled
GPO1/ALERT1/CONV PIN						
Output Low Voltage	V_{OL_GPO1}			0.4	V	$I_{GPO1} = 1\text{ mA}$
				1.5	V	$I_{GPO1} = 5\text{ mA}$
Leakage Current				± 100	nA	$V_{GPO1} \leq 2\text{ V}$, GPO1 output high-Z
				1	μA	$V_{GPO1} = 20\text{ V}$, GPO1 output high-Z
Input High Voltage	V_{IH}	1.1			V	Configured as CONV pin
Input Low Voltage	V_{IL}			0.8	V	Configured as CONV pin
Glitch Filter			1		μs	Configured as CONV pin
GPO2/ALERT2 PIN						
Output Low Voltage	V_{OL_GPO2}			0.4	V	$I_{GPO2} = 1\text{ mA}$
				1.5	V	$I_{GPO2} = 5\text{ mA}$
Leakage Current				± 100	nA	$V_{GPO2} \leq 2\text{ V}$, GPO2 output high-Z
				± 1	μA	$V_{GPO2} = 20\text{ V}$, GPO2 output high-Z

Parameter	Symbol	Min	Typ	Max	Unit	Test Conditions/Comments
GRADE A DEVICE CURRENT AND VOLTAGE MONITORING						
Current Sense Absolute Error						128 sample averaging, $V_{SENSEP} = 0\text{ V to }18\text{ V}$ (unless otherwise noted)
Current Sense Range (CSR) = $\pm 25\text{ mV}$			0.04	0.33	%	$V_{SENSE} = V_{SENSEP} - V_{SENSEN} = \pm 20\text{ mV}$, $T_A = -40^\circ\text{C to }+85^\circ\text{C}$
				0.38	%	$V_{SENSE} = \pm 20\text{ mV}$
				0.72	%	$V_{SENSE} = \pm 20\text{ mV}$, 16 sample averaging
				2.65	%	$V_{SENSE} = \pm 20\text{ mV}$, one sample averaging
				1	%	$V_{SENSE} = \pm 20\text{ mV}$, $V_{SENSEP} = 18\text{ V to }20\text{ V}$
				0.35	%	$V_{SENSE} = \pm 25\text{ mV}$
				0.44	%	$V_{SENSE} = \pm 15\text{ mV}$
				0.59	%	$V_{SENSE} = \pm 10\text{ mV}$
				1	%	$V_{SENSE} = \pm 5\text{ mV}$
				2	%	$V_{SENSE} = \pm 2.5\text{ mV}$
				5	%	$V_{SENSE} = \pm 1\text{ mV}$
CSR = $\pm 50\text{ mV}$				0.26	%	$V_{SENSE} = \pm 40\text{ mV}$
				0.4	%	$V_{SENSE} = \pm 20\text{ mV}$
CSR = $\pm 100\text{ mV}$				0.23	%	$V_{SENSE} = \pm 80\text{ mV}$
				0.3	%	$V_{SENSE} = \pm 40\text{ mV}$
CSR = $\pm 200\text{ mV}$				0.21	%	$V_{SENSE} = \pm 160\text{ mV}$
				0.27	%	$V_{SENSE} = \pm 80\text{ mV}$
Voltage Sense Absolute Error						128 sample averaging
VIN				0.35	%	$V_{VIN} = 10\text{ V to }20\text{ V}$, $V_{RANGE} = 21\text{ V}$
				0.26	%	$V_{VIN} = 3.6\text{ V to }7.4\text{ V}$, $V_{RANGE} = 7.4\text{ V}$
				0.2	%	$V_{VIN} = 0.6\text{ V to }1.2\text{ V}$, $V_{RANGE} = 1.2\text{ V}$, $T_A = -40^\circ\text{C to }+85^\circ\text{C}$
				0.24	%	$V_{VIN} = 0.6\text{ V to }1.2\text{ V}$, $V_{RANGE} = 1.2\text{ V}$
VAUX				0.2	%	$V_{VAUX} = 0.6\text{ V to }1.2\text{ V}$, $T_A = -40^\circ\text{C to }+85^\circ\text{C}$
				0.24	%	$V_{VAUX} = 0.6\text{ V to }1.2\text{ V}$
Power Absolute Error				0.48	%	$V_{SENSE} = \pm 20\text{ mV}$, $SENSEP = VIN = 12\text{ V}$, $V_{RANGE} = 21\text{ V}$, $T_A = -40^\circ\text{C to }+85^\circ\text{C}$
				0.54	%	$V_{SENSE} = \pm 20\text{ mV}$, $SENSEP = VIN = 12\text{ V}$, $V_{RANGE} = 21\text{ V}$
				0.5	%	$V_{SENSE} = \pm 20\text{ mV}$, $SENSEP = VIN = 3.3\text{ V}$, $V_{RANGE} = 7.4\text{ V}$, $T_A = -40^\circ\text{C to }+85^\circ\text{C}$
				0.54	%	$V_{SENSE} = \pm 20\text{ mV}$, $SENSEP = VIN = 3.3\text{ V}$, $V_{RANGE} = 7.4\text{ V}$
				0.48	%	$V_{SENSE} = \pm 20\text{ mV}$, $SENSEP = 20\text{ mV}$, $VIN = 0.8\text{ V}$, $V_{RANGE} = 1.2\text{ V}$, $T_A = -40^\circ\text{C to }+85^\circ\text{C}$
				0.53	%	$V_{SENSE} = \pm 20\text{ mV}$, $SENSEP = 20\text{ mV}$, $VIN = 0.8\text{ V}$, $V_{RANGE} = 1.2\text{ V}$
GRADE B DEVICE CURRENT AND VOLTAGE MONITORING						
Current Sense Absolute Error						128 sample averaging (unless otherwise noted)
CSR = $\pm 25\text{ mV}$			0.1	0.75	%	$V_{SENSE} = V_{SENSEP} - V_{SENSEN} = \pm 20\text{ mV}$, $T_A = -40^\circ\text{C to }+85^\circ\text{C}$
				0.84	%	$V_{SENSE} = \pm 20\text{ mV}$
				1.6	%	$V_{SENSE} = \pm 20\text{ mV}$, 16 sample averaging
				5.8	%	$V_{SENSE} = \pm 20\text{ mV}$, one sample averaging
				2.2	%	$V_{SENSE} = \pm 20\text{ mV}$, $V_{SENSEP} = 18\text{ V to }20\text{ V}$
				0.8	%	$V_{SENSE} = \pm 25\text{ mV}$
				1	%	$V_{SENSE} = \pm 15\text{ mV}$
				1.3	%	$V_{SENSE} = \pm 10\text{ mV}$
				4.5	%	$V_{SENSE} = \pm 2.5\text{ mV}$
				11	%	$V_{SENSE} = \pm 1\text{ mV}$
CSR = $\pm 50\text{ mV}$				0.57	%	$V_{SENSE} = \pm 40\text{ mV}$
				0.9	%	$V_{SENSE} = \pm 20\text{ mV}$

Parameter	Symbol	Min	Typ	Max	Unit	Test Conditions/Comments
CSR = ±100 mV				0.55	%	V _{SENSE} = ±80 mV
				0.7	%	V _{SENSE} = ±40 mV
CSR = ±200 mV				0.5	%	V _{SENSE} = ±160 mV
				0.6	%	V _{SENSE} = ±80 mV
Voltage Sense Absolute Error VIN				0.8	%	128 sample averaging V _{VIN} = 10 V to 20 V, V _{RANGE} = 21 V
				0.6	%	V _{VIN} = 3.6 V to 7.4 V, V _{RANGE} = 7.4 V
				0.45	%	V _{VIN} = 0.6 V to 1.2 V, V _{RANGE} = 1.2 V, T _A = -40°C to +85°C
				0.6	%	V _{VIN} = 0.6 V to 1.2 V, V _{RANGE} = 1.2 V
VAUX				0.45	%	V _{VAUX} = 0.6 V to 1.2 V, T _A = -40°C to +85°C
				0.6	%	V _{VAUX} = 0.6 V to 1.2 V
Power Absolute Error				1.2	%	V _{SENSE} = ±20 mV, SENSEP = VIN = 12 V, V _{RANGE} = 21 V
				1.2	%	V _{SENSE} = ±20 mV, SENSEP = VIN = 3.3 V, V _{RANGE} = 7.4 V
				1.2	%	V _{SENSE} = ±20 mV, SENSEP = 20 mV, VIN = 0.8 V, V _{RANGE} = 1.2 V
ADC CONVERSION TIME						Includes time for power multiplication
			144	165	μs	One sample of IOOUT, from command received to valid data in register
			64	73	μs	One sample of VIN, from command received to valid data in register
			64	73	μs	One sample of VAUX, from command received to valid data in register
ADRx PINS						
Address Set to 00		0		0.8	V	Connect to VEE
Input Current for Address 00		-40	-22		μA	V _{ADRx} = 0 V to 0.8 V
Address Set to 01		135	150	165	kΩ	Resistor to VEE
Address Set to 10		-1		+1	μA	No connect state, maximum leakage current allowed
Address Set to 11		2			V	Connect to VCAP
Input Current for Address 11			3	10	μA	V _{ADRx} = 2.0 V to VCAP, must not exceed the maximum allowable current draw from VCAP
SERIAL BUS DIGITAL I/O						SDAI, SDAO, SCL
Input High Voltage	V _{IH}	1.1			V	
Input Low Voltage	V _{IL}			0.8	V	
SDAO Output Low Voltage	V _{OL}			0.4	V	I _{OL} = 4 mA
Input Leakage	I _{LEAK_PIN}	-10		+10	μA	
		-5		+5	μA	Device is not powered
Nominal Bus Voltage	V _{DD}	2.7		5.5	V	3 V to 5 V ± 10%
Capacitance for I/O Pins	C _{PIN}		5		pF	
Input Glitch Filter	t _{SP}	0		50	ns	

SERIAL BUS TIMING CHARACTERISTICS

Table 2.

Parameter	Description	Min	Typ	Max	Unit
f_{SCLK}	Clock frequency			400	kHz
t_{BUF}	Bus free time	1.3			μ s
$t_{HD;STA}$	Start hold time	0.6			μ s
$t_{SU;STA}$	Start setup time	0.6			μ s
$t_{SU;STO}$	Stop setup time	0.6			μ s
$t_{HD;DAT}$	SDA hold time	300		900	ns
$t_{SU;DAT}$	SDA setup time	100			ns
t_{LOW}	SCL low time	1.3			μ s
t_{HIGH}	SCL high time	0.6			μ s
t_r^1	SCL, SDA rise time	20		300	ns
t_f	SCL, SDA fall time	20		300	ns

¹ $t_r = (V_{IL(MAX)} - 0.15)$ to $(V_{IH3V3} + 0.15)$ and $t_f = 0.9 V_{DD}$ to $(V_{IL(MAX)} - 0.15)$, where $V_{IH3V3} = 2.1$ V, and $V_{DD} = 3.3$ V.

Serial Bus Timing Diagram

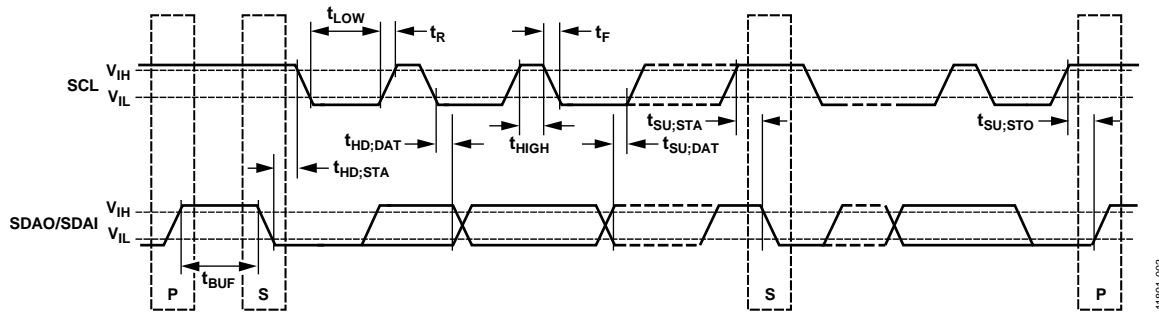

Figure 3. Serial Bus Timing Diagram

11891-003

ABSOLUTE MAXIMUM RATINGS

Pin voltages on the [ADM1293](#) are referenced to the GND pin and pin voltages on the [ADM1294](#) are referenced to the VEE pin.

Table 3.

Parameter	Rating
VCC Pin	–0.3 V to +25 V
VSHUNT Pin	–0.3 V to +14 V
VCAP Pin	–0.3 V to +4 V
SCL Pin	–0.3 V to +6.5 V
SDAI Pin	–0.3 V to +6.5 V
SDAO Pin	–0.3 V to +6.5 V
ADR1 Pin	–0.3 V to VCAP + 0.3 V
ADR2 Pin	–0.3 V to VCAP + 0.3 V
GPO1/ <u>ALERT1</u> /CONV Pin	–0.3 V to +25 V
GPO2/ <u>ALERT2</u> Pin	–0.3 V to +25 V
VIN Pin	–0.3 V to +25 V
VAUX Pin	–0.3 V to +4 V
SENSEP Pin	–0.3 V to +25 V
SENSEN Pin	–0.3 V to +25 V
Continuous Current into VSHUNT Pin	30 mA
Continuous Current into Any Other Pin	±10 mA
Storage Temperature Range	–65°C to +150°C
Operating Ambient Temperature Range	
ADM1293	–40°C to +105°C
Operating Junction Temperature Range	
ADM1294	–40°C to +105°C
Junction Temperature Range	–40°C to +110°C
Lead Temperature, Soldering (10 sec)	300°C
Junction Temperature	150°C

Stresses at or above those listed under Absolute Maximum Ratings may cause permanent damage to the product. This is a stress rating only; functional operation of the product at these or any other conditions above those indicated in the operational section of this specification is not implied. Operation beyond the maximum operating conditions for extended periods may affect product reliability.

THERMAL CHARACTERISTICS

θ_{JA} is specified for the worst case conditions, that is, a device soldered in a circuit board for surface-mount packages.

Table 4. Thermal Resistance

Package Type	θ_{JA}	Unit
16-Lead LFCSP	50.58	°C/W
14-Lead TSSOP	122.73	°C/W

ESD CAUTION



ESD (electrostatic discharge) sensitive device. Charged devices and circuit boards can discharge without detection. Although this product features patented or proprietary protection circuitry, damage may occur on devices subjected to high energy ESD. Therefore, proper ESD precautions should be taken to avoid performance degradation or loss of functionality.

PIN CONFIGURATIONS AND FUNCTION DESCRIPTIONS



NOTES
 1. NIC = NOT INTERNALLY CONNECTED.
 2. EXPOSED PAD. SOLDER THE EXPOSED PAD TO THE BOARD TO IMPROVE THERMAL DISSIPATION. THE EXPOSED PAD CAN BE CONNECTED TO GND.

Figure 4. ADM1293 LFCSP Pin Configuration



Figure 5. ADM1293 TSSOP Pin Configuration

Table 5. ADM1293 Pin Function Descriptions

Pin No.		Mnemonic	Description
LFCSP	TSSOP ¹		
16	1	VAUX	Auxiliary Voltage Monitoring Input. This pin reads back the auxiliary input voltage using the internal ADC. An external divider is required to monitor voltages higher than 1.2 V.
1	2	VCC	Positive Supply Input. An undervoltage lockout (UVLO) circuit resets the device when a low supply voltage is detected. A 0.1 μF decoupling capacitor must be placed close to the VCC pin.
2	3	VCAP	Internal Regulated Supply. Place a capacitor with a value of 1 μF or greater on this pin to maintain accuracy.
3	4	ADR1	PMBus Address. This pin can be tied low, tied to VCAP, left floating, or tied low through a resistor. Combine with the ADR2 pin to set up to 16 different PMBus addresses.
4	5	ADR2	PMBus Address. This pin can be tied low, tied to VCAP, left floating, or tied low through a resistor. Combine with the ADR1 pin to set up to 16 different PMBus addresses.
5	6	SDAI	PMBus Serial Data Input. This is a split version of the SDA for easy use with optocouplers. Tie this pin directly to the SDAO pin if a bus split is not required.
6	7	SDAO	PMBus Serial Data Output. This is a split version of the SDA for easy use with optocouplers. Tie this pin directly to the SDAI pin if a bus split is not required.
7	8	SCL	PMBus Serial Clock. Open-drain input. Requires an external resistive pull-up.
8	9	GPO1/ALERT1/CONV	General-Purpose Digital Output (GPO1). Alert (ALERT1). This pin can be configured to generate an alert signal when one or more warning conditions are detected. Conversion (CONV). This pin can be used as an input signal to control when a power monitor ADC sampling cycle begins. This pin defaults to an alert output at power up. There is no internal pull-up on this pin.
9	10	GPO2/ALERT2	General-Purpose Digital Output (GPO2). Alert (ALERT2). This pin can be configured to generate an alert signal when one or more warning conditions are detected. This pin defaults to an alert output at power up. There is no internal pull-up on this pin.
10	N/A	NIC	Not Internally Connected. This pin is not internally connected.
11	11	SENSEN	Negative Current Sense Input.
12	12	SENSEP	Positive Current Sense Input.
13	13	VIN	Primary Voltage Monitoring Input. This pin reads back the primary input voltage using the internal ADC. The internal divider allows this pin to directly monitor a 20 V supply. An external divider is required to monitor voltages higher than 20 V.
14	N/A	NIC	Not Internally Connected. This pin is not internally connected.
15	14	GND	Chip Ground. This pin must connect to the lowest potential.
EPAD	N/A	EPAD	Exposed Pad. Solder the exposed pad to the board to improve thermal dissipation. Connect the exposed pad to GND.

¹ N/A means not applicable.



NOTES

1. NIC = NOT INTERNALLY CONNECTED.
2. EXPOSED PAD. SOLDER THE EXPOSED PAD TO THE BOARD TO IMPROVE THERMAL DISSIPATION. THE EXPOSED PAD CAN BE CONNECTED TO VEE.

Figure 6. ADM1294 LFCSP Pin Configuration



Figure 7. ADM1294 TSSOP Pin Configuration

Table 6. ADM1294 Pin Function Descriptions

Pin No.		Mnemonic	Description
LFCSP	TSSOP ¹		
16	1	VAUX	Auxiliary Voltage Monitoring Input. This pin reads back the auxiliary input voltage using the internal ADC. An external divider is required to monitor voltages higher than 1.2 V.
1	2	VSHUNT	Shunt Regulated Positive Supply to Chip. Connect this pin to the positive supply rail. A shunt resistor in series is required to limit the input current if the supply voltage is higher than the shunt regulation voltage. A 1 μ F decoupling capacitor to VEE is recommended on the VSHUNT pin.
2	3	VCAP	Internal Regulated Supply. Place a capacitor with a value of 1 μ F or greater on this pin to maintain accuracy.
3	4	ADR1	PMBus Address. This pin can be tied low, tied to VCAP, left floating, or tied low through a resistor. Combine with the ADR2 pin to set up to 16 different PMBus addresses.
4	5	ADR2	PMBus Address. This pin can be tied low, tied to VCAP, left floating, or tied low through a resistor. Combine with the ADR1 pin to set up to 16 different PMBus addresses.
5	6	SDAI	PMBus Serial Data Input. This is a split version of the SDA for easy use with optocouplers. Tie this pin directly to the SDAO pin if a bus split is not required.
6	7	SDAO	PMBus Serial Data Output. This is a split version of the SDA for easy use with optocouplers. Tie this pin directly to the SDAI pin if a bus split is not required.
7	8	SCL	PMBus Serial Clock. Open-drain input. Requires an external resistive pull-up.
8	9	GPO1/ALERT1/CONV	General-Purpose Digital Output (GPO1). Alert (ALERT1). This pin can be configured to generate an alert signal when one or more warning conditions are detected. Conversion (CONV). This pin can be used as an input signal to control when a power monitor ADC sampling cycle begins. This pin defaults to an alert output at power up. There is no internal pull-up on this pin.
9	10	GPO2/ALERT2	General-Purpose Digital Output (GPO2). Alert (ALERT2). This pin can be configured to generate an alert signal when one or more warning conditions are detected. This pin defaults to an alert output at power up. There is no internal pull-up on this pin.
10	N/A	NIC	Not Internally Connected. This pin is not internally connected.
11	11	SENSEN	Negative Current Sense Input.
12	12	SENSEP	Positive Current Sense Input.
13	13	VIN	Primary Voltage Monitoring Input. This pin reads back the primary input voltage using the internal ADC. The internal divider allows this pin to directly monitor a 20 V supply. An external divider is required to monitor voltages higher than 20 V.
14	N/A	NIC	Not Internally Connected. This pin is not internally connected.
15	14	VEE	Chip Ground Pin. This pin must connect to the lowest potential.
EPAD	N/A	EPAD	Exposed Pad. Solder the exposed pad to the board to improve thermal dissipation. Connect the exposed pad to VEE.

¹ N/A means not applicable.

TYPICAL PERFORMANCE CHARACTERISTICS



Figure 8. I_{CC} vs. Pin Voltages



Figure 11. ADM1293 SENSEP/SENSEN Pins Input Current vs. SENSEP and SENSEN Pin Voltage



Figure 9. I_{CC} vs. Temperature



Figure 12. ADM1293 Total SENSEP and SENSEN Pins Input Current vs. SENSEP and SENSEN Pin Voltage

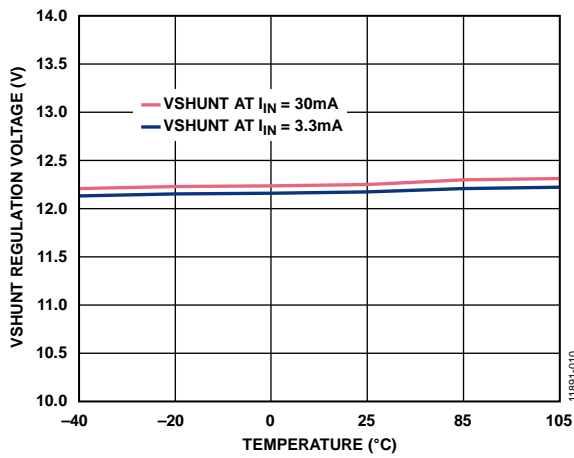

Figure 10. VSHUNT Regulation Voltage vs. Temperature



Figure 13. Total SENSEP and SENSEN Input Current vs. Temperature



Figure 14. SENSEP and SENSEN Pins Input Current Imbalance vs. SENSEP and SENSEN Pins Differential Voltage



Figure 17. VIN/VAUX Input Currents vs. VIN/VAUX Voltage



Figure 15. SENSEN and SENSEP Input Current Imbalance vs. Temperature

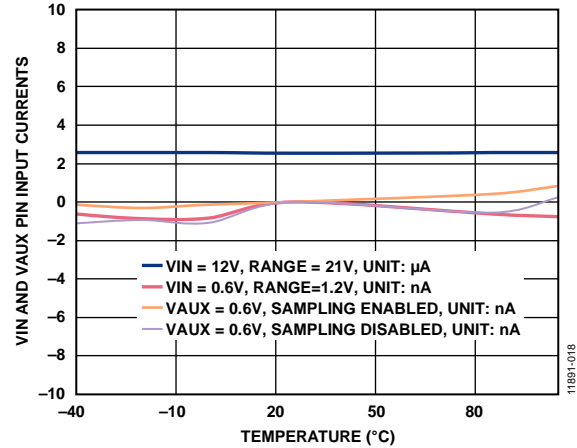

Figure 18. VIN/VAUX Input Currents vs. Temperature



Figure 16. VIN Input Current vs. VIN Pin Voltage, $V_{RANGE} = 0V$ to $7.4V$ or $0V$ to $21V$



Figure 19. Worst Case Current Sense Error vs. Current Sense Voltage with 128 Sample Averaging, $V_{SENSEP} = 0V$ to $18V$, over Full Operating Temperature Range



Figure 20. V_{ADRx} vs. I_{ADRx}

11891-020



Figure 21. GPOx Output Low Voltage vs. Sink Current

11891-021

THEORY OF OPERATION

POWERING THE ADM1293

A supply voltage from 2.95 V to 20 V is required to power the ADM1293 via the VCC pin. The VCC pin provides the majority of the bias current for the device.

To ensure correct operation of the ADM1293, the voltage on the VCC pin must be greater than or equal to the voltage on the SENSEP pin. No sequencing of the VCC and SENSEP rails is necessary. The voltage on SENSEP pin can drop to as low as 0 V for normal operation, provided that a voltage of at least 2.95 V is connected to the VCC pin. For a monitoring supply rail above 3 V, connect both the VCC pin and the SENSEP pin to the same voltage rail via separate traces to prevent accuracy loss in the sense voltage measurement (see Figure 22).



Figure 22. Powering the ADM1293 from a Monitoring Rail

To protect the ADM1293 from unnecessary resets due to transient supply glitches, add an external resistor, as shown in Figure 23. Choose the values of the resistor in conjunction with the decoupling capacitor such that a time constant is provided that can filter any expected glitches. However, use a resistor that is small enough to keep voltage drops due to quiescent current to a minimum.



Figure 23. Transient Glitch Protection Using an RC Network

For monitoring rails below 2.95 V to 0 V, a separate supply is required to provide power to the ADM1293, as shown in Figure 24.



Figure 24. Powering the ADM1293 from a Separate Supply

POWERING THE ADM1294

The internal shunt regulator allows ADM1294 to be powered directly from a high voltage source. The shunt regulator is disabled when the supply voltage on the VSHUNT pin is below the shunt regulation voltage level. After the supply rises above the shunt regulation level, the shunt regulator starts to regulate the voltage on the VSHUNT pin to approximately 12 V. An external current limiting resistor is required to limit the current entering the VSHUNT pin, as shown in Figure 25.



Figure 25. Powering the ADM1294 in a -48 V System

The shunt regulator also maintains a stable supply voltage during transient events on the input supply, protecting the ADM1294 from experiencing overvoltage stress.

Shunt Current Limiting Resistor Selection

The current limiting resistor value must be calculated correctly to provide sufficient current/voltage to power the ADM1294, while keeping the power low enough to prevent the IC from overheating.

Calculate the current limiting resistance upper limit by

$$R_{SHUNT_MAX} = \frac{V_{INPUT_MIN} - V_{OP4_MIN}}{I_{CC4_MAX}}$$

where:

V_{INPUT_MIN} is the minimum supply input voltage before the current limiting resistor.

V_{OP4_MIN} is the minimum operating voltage of the ADM1294.

I_{CC4_MAX} is the maximum supply current of the ADM1294.

When the ADM1294 is in shunt regulation mode, if the supply voltage decreases to a point where the current flowing through the current limiting resistor is not enough to power the IC, the ADM1294 automatically exits the fixed voltage regulation mode and enters into current regulation mode. In current regulation mode, the device lowers the voltage on the VSHUNT pin to maintain the current required to power itself. The VSHUNT pin voltage can be decreased to the minimum operating voltage of the ADM1294. The smooth transition in and out of shunt regulation mode helps to increase the R_{SHUNT_MAX} value, and as a result, extends the range of the suitable current limiting resistors.

Calculate the current limiting resistance lower limit by

$$R_{SHUNT_MIN} = \frac{V_{INPUT_MAX} - V_{SHUNT_MAX}}{I_{SHUNT_MAX}}$$

where:

V_{INPUT_MAX} is the maximum supply input voltage before the current limiting resistor.

V_{SHUNT_MAX} is the maximum shunt regulation voltage of the [ADM1294](#).

I_{SHUNT_MAX} is the maximum current allowed into the shunt regulator. It is related to the maximum allowable power dissipation of the device in a given design, which is limited by the maximum junction temperature of the device.

$$I_{SHUNT_MAX} = \frac{P_{DISS_MAX}}{V_{SHUNT_MAX}}$$

and

$$P_{DISS_MAX} = \frac{T_{J_MAX} - T_{A_MAX}}{\theta_{JA}}$$

where:

T_{J_MAX} is the maximum junction temperature of the [ADM1294](#).

T_{A_MAX} is the maximum ambient temperature of the system.

θ_{JA} is the junction to ambient thermal resistance of the [ADM1294](#).

Example 1: A system has a -48 V supply that can vary between -35 V to -75 V. The system maximum ambient temperature is 85°C. An [ADM1294](#) in an LFCSP package monitors the supply. It is soldered on a JEDEC 2S2P board, with a minimal footprint and a 3 × 3 thermal via array.

Note that because the [ADM1294](#) uses low-side sensing, as shown in Figure 25, all of the voltages are expressed by referencing to the negative supply input.

$$R_{SHUNT_MAX} = \frac{V_{INPUT_MIN} - V_{OP4_MIN}}{I_{CC4_MAX}} = \frac{35\text{ V} - 2.95\text{ V}}{3.6\text{ mA}} = 8.9\text{ k}\Omega$$

$$P_{DISS_MAX} = \frac{T_{JMAX} - T_{AMAX}}{\theta_{JA}} = \frac{110^\circ\text{C} - 85^\circ\text{C}}{50.58^\circ\text{C}} = 0.494\text{ W}$$

$$I_{SHUNT_MAX} = \frac{P_{DISS_MAX}}{V_{SHUNT_MAX}} = \frac{0.494\text{ W}}{13\text{ V}} = 38\text{ mA}$$

$$R_{SHUNT_MIN} = \frac{V_{INPUT_MIN} - V_{SHUNT_MAX}}{I_{SHUNT_MAX}} = \frac{75\text{ V} - 13\text{ V}}{38\text{ mA}} = 1.63\text{ k}\Omega$$

The user can select a current limiting resistor with a value between 8.9 kΩ and 1.63 kΩ. It is recommended to select one at the higher end to reduce power dissipation. After a value is chosen, for example, 7.5 kΩ, the user must check its worst-case power dissipation. In this example, the worst case is when the input supply is at its maximum value.

The worst case power dissipation across the current limiting resistor is

$$P_{R_WORST} = \frac{(V_{INPUT_MAX} - V_{SHUNT_MIN})^2}{R_{SHUNT}} = \frac{(75\text{ V} - 11.5\text{ V})^2}{7.5\text{ k}\Omega} = 0.54\text{ W}$$

The user may need multiple resistors in series or in parallel to meet the power level that is required.

Example 2: A system has a 180 V supply that can vary between -160 V to +200 V. The system maximum ambient temperature is 105°C. An [ADM1294](#) in the LFCSP package monitors the supply. It is soldered on a JEDEC 2S2P board, with a minimal footprint and a 3 × 3 thermal via array.

$$R_{SHUNT_MAX} = \frac{V_{INPUT_MIN} - V_{OP4_MIN}}{I_{CC4_MAX}} = \frac{160\text{ V} - 2.95\text{ V}}{3.6\text{ mA}} = 43.6\text{ k}\Omega$$

$$P_{DISS_MAX} = \frac{T_{JMAX} - T_{AMAX}}{\theta_{JA}} = \frac{110^\circ\text{C} - 105^\circ\text{C}}{50.58^\circ\text{C}} = 0.1\text{ W}$$

$$I_{SHUNT_MAX} = \frac{P_{DISS_MAX}}{V_{SHUNT_MAX}} = \frac{0.1\text{ W}}{13\text{ V}} = 7.7\text{ mA}$$

$$R_{SHUNT_MIN} = \frac{V_{INPUT_MIN} - V_{SHUNT_MAX}}{I_{SHUNT_MAX}} = \frac{200\text{ V} - 13\text{ V}}{7.7\text{ mA}} = 24.3\text{ k}\Omega$$

The user can select a current limiting resistor with a value between 43.6 kΩ and 24.3 kΩ. This example uses a 39 kΩ resistor.

The worst case power dissipation across the current limiting resistor is:

$$P_{R_WORST} = \frac{(V_{INPUT_MAX} - V_{SHUNT_MIN})^2}{R_{SHUNT}} = \frac{(200\text{ V} - 11.5\text{ V})^2}{39\text{ k}\Omega} = 0.91\text{ W}$$

The user may need multiple resistors in series or in parallel to meet the power level that is required.

Additional Options of Powering the [ADM1294](#)

If the supply input range is too wide to choose a suitable current limiting resistor or causing too much power loss, a source follower circuit can be used to generate the supply voltage for the [ADM1294](#), as shown in Figure 26.

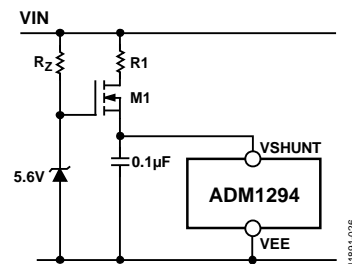

Figure 26. Powering the [ADM1294](#) Through a Source Follower Circuit

In this circuit, R_Z limits the current into the Zener diode, the NMOSFET (or an NPN transistor in the case of an emitter follower) buffers the voltage created by the Zener to supply the ADM1294. The NMOS must be able to withstand the voltage drop of the supply voltage and the worst case power dissipation. The worst case power dissipation is expressed as

$$P_{FET_WORST} = (V_{INPUT_MAX} - V_{ZENER} + V_{TH}) \times I_{CC_MAX}$$

where:

V_{INPUT_MAX} is the maximum supply input voltage before the current limiting resistor.

V_{ZENER} is the Zener diode reverse breakdown voltage.

V_{TH} is the threshold of the NMOSFET or base to emitter voltage in the case of an NPN emitter follower.

I_{CC_MAX} is the maximum supply current of the ADM1294.

Another option to supply power to the ADM1294 is to use the ADM3260 I²C and a power isolator, as shown in Figure 27.



Figure 27. Powering the ADM1294 Using the ADM3260 I²C and Power Isolator

Isolation is usually required in -48 V systems because there can be a large voltage difference between different ground planes in the system. The ADM1294 is referenced to -48 V, whereas the microcontroller unit (MCU) is usually referenced to 0 V. In almost all cases, the I²C signals must be isolated. Any other ADM1294 digital input and output signals that enter or exit the MCU must also be isolated.

The ADM3260 isolator can transfer power and a bidirectional I²C digital signal across an isolation barrier of up to 2.5 kV. The output voltage from the ADM3260 can power the ADM1294 directly as well as providing pull-up resistance for the I²C bus lines. See the ADM3260 data sheet for more information about this device.

OPTIONAL POWER MONITOR INPUTS FILTERING

The internal ADC on both the ADM1293 and ADM1294 uses the current sense input pins, SENSEP and SENSEN, to measure the load current. Additional antialiasing filtering can be placed on the power monitor pins to reduce current monitoring noise. Similarly, RC filters can be used on the voltage sensing inputs, VIN and VAUX, to reduce voltage sensing noise.



Figure 28. Power Monitor Input Filters for the ADM1293



Figure 29. Power Monitor Input Filters for the ADM1294

POWER MONITOR

The ADM1293/ADM1294 feature an integrated ADC that accurately measures the current sense voltage, the input voltage, and optionally, an auxiliary input voltage. The measured input voltage, and current being delivered to the load are multiplied together to give a power value that can be read back. Each power value is also added to an energy accumulator that can be read back to allow an external device to calculate the energy consumption of the load.

The ADM1293/ADM1294 can report the measured current, input voltage, and auxiliary voltage. The PEAK_VIN, PEAK_VAUX, MIN_IOUT, MAX_IOUT, MIN_PIN, and MAX_PIN commands are used to read the peak readings since the value was last cleared.

An averaging function of up to 128× is provided for the voltage, current, and power. This function allows a number of samples to be averaged together by the ADM1293/ADM1294. This function reduces the need for postprocessing of sampled data by the host processor. The number of samples that can be averaged is 2^N , where N is in the range of 0 to 7.

The power averaging is calculated independently of voltage and current averaging value to give the most accurate result. For example, if the two consecutive voltage measurement results are 12.00 V and 12.08 V, and the corresponding current measurement results are 10.0 A and 10.8 A, and the 2× averaging results for voltage and current are 12.04 V and 10.4 A, respectively, then the 2× power averaging result is

$$\frac{12 \times 10 + 12.08 \times 10.8}{2} = 125.232 \text{ W}$$

Not $12.04 \times 10.4 = 125.216 \text{ W}$.

The power monitor current sense amplifier is bipolar and can measure both positive and negative currents. The current sense amplifier has four selectable input ranges: ± 25 mV, ± 50 mV, ± 100 mV, and ± 200 mV. Operating closer to the full range results in higher current measurement accuracy and higher insertion loss across the sense resistor.

The power monitor voltage sensing input, VIN, has three selectable input ranges: 0 V to 1.2 V, 0 V to 7.6 V, and 0 V to 21 V. Configuring the VIN pin to the 0 V to 1.2 V range gives the pin a direct connection to the internal ADC, and results in minimum leakage current into the pin. It is the recommended configuration for use with external resistor dividers. The VAUX input has a fixed 0 V to 1.2 V voltage monitoring range. Both the current and voltage sensing ranges can be configured using the PMON_CONFIG command.

The two basic modes of operation for the power monitor are single shot and continuous. In single shot mode, the ADC samples the input voltage and current a number of times, depending on the averaging value selected by the user. The ADM1293/ADM1294 return a single value corresponding to the average voltage and current measured. When configured for continuous mode, the power monitor continuously samples the voltage and current, making the most recent sample available to be read.

Single shot mode can be triggered in a number of ways. The simplest is by selecting the single shot mode using the PMON_CONFIG command and writing to the convert bit using the PMON_CONTROL command. The convert bit can also be written as part of a PMBus group command. Using a group command allows multiple devices to be written to as part of the same I²C bus transaction, with all devices executing the command when the stop condition appears on the bus. In this way, several devices can be triggered to sample at the same time.

When the GPO1/ALERT1/CONV pin is set to convert (CONV) mode, an external hardware signal triggers the single shot sampling of one or more parts at the same time.

Each time that current sense and input voltage measurements are taken, a power calculation is performed that multiplies the two measurements together. This can be read from the device using the READ_PIN command, returning the input power.

At the same time, the calculated power value is added to the power accumulator register that may increment a rollover counter if the value exceeds the maximum accumulator value. The power accumulator register also increments a power sample counter.

The power accumulator and power sample counter are read using the same READ_EIN command to ensure that the accumulated value and sample count are from the same point in time. The bus host reading the data assigns a time stamp when the data is read. By calculating the time difference between consecutive uses of READ_EIN and determining the delta in power consumed, it is possible for the host to determine the total energy consumed over that period.

Table 7. ADM1293 and ADM1294 Model Options

Model	Build in Shunt Regulator	Monitoring Accuracy Grade	Energy Meter Implementation
ADM1293-1A	No	A	Custom
ADM1293-1B	No	B	Custom
ADM1294-1A	Yes	A	Custom
ADM1294-1B	Yes	B	Custom
ADM1293-2A	No	A	PMBus Standard
ADM1294-2A	Yes	A	PMBus Standard

PMBus INTERFACE

The I²C bus is a common, simple serial bus used by many devices to communicate. It defines the electrical specifications, the bus timing, the physical layer, and some basic protocol rules.

SMBus is based on I²C and aims to provide a more robust and fault tolerant bus. Functions such as bus timeout and packet error checking are added to help achieve this robustness, along with more specific definitions of the bus messages that read and write data to devices on the bus.

PMBus is layered on top of SMBus and, in turn, on I²C. Using the SMBus defined bus messages, PMBus defines a set of standard commands that control a device that is part of a power chain.

The [ADM1293/ADM1294](#) command set is based upon the *PMBus™ Power System Management Protocol Specification*, Part I and Part II, Revision 1.2. This version of the standard is provides a common set of commands for communicating with dc-to-dc type devices. However, many of the standard PMBus commands can be mapped directly to the functions of a digital power monitor.

Part I and Part II of the PMBus standard describe the basic commands and how they are used in a typical PMBus setup. The following sections describe how the PMBus standard and the [ADM1293/ADM1294](#) specific commands are used.

DEVICE ADDRESSING

The PMBus device address is seven bits in size. There are no default addresses for any of the models; any device can be programmed to any of 16 possible addresses. Two quad level ADRx pins map to the 16 possible device addresses.

Table 8. ADRx Pin Connections

ADR _x State	ADR _x Pin Connection
Low	Connect to GND
Resistor	150 kΩ resistor to GND
High-Z	No connection (floating)
High	Connect to VCAP

Table 9. Setting I²C Addresses via the ADR1 Pin and the ADR2 Pin

Base Address (Binary)	ADR2 Pin State	ADR1 Pin State	ADR2 Logic State	ADR1 Logic State	Address (Binary) ¹	Address (Hex)
011	Ground	Ground	00	00	0110000X	0x30
	Ground	Resistor to ground	00	01	0110001X	0x31
	Ground	Floating	00	10	0110010X	0x32
	Ground	High	00	11	0110011X	0x33
	Resistor to ground	Ground	01	00	0110100X	0x34
	Resistor to ground	Resistor to ground	01	01	0110101X	0x35
	Resistor to ground	Floating	01	10	0110110X	0x36
	Resistor to ground	High	01	11	0110111X	0x37
	Floating	Ground	10	00	0111000X	0x38
	Floating	Resistor to ground	10	01	0111001X	0x39
	Floating	Floating	10	10	0111010X	0x3A
	Floating	High	10	11	0111011X	0x3B
	High	Ground	11	00	0111100X	0x3C
	High	Resistor to ground	11	01	0111101X	0x3D
	High	Floating	11	10	0111110X	0x3E
	High	High	11	11	0111111X	0x3F

¹ X means don't care.

SMBus PROTOCOL USAGE

All I²C transactions on the ADM1293/ADM1294 are performed using SMBus defined bus protocols. The following SMBus protocols are implemented by the ADM1293/ADM1294:

- Send byte
- Receive byte
- Write byte
- Read byte
- Write word
- Read word
- Block read

PACKET ERROR CHECKING

The ADM1293/ADM1294 PMBus interface supports the use of the packet error checking (PEC) byte, which is defined in the SMBus standard. The PEC byte is transmitted by the ADM1293/ADM1294 during a read transaction or sent by the bus host to the ADM1293/ADM1294 during a write transaction. The ADM1293/ADM1294 support the use of PEC with all the SMBus protocols that it implements.

The use of the PEC byte is optional. The bus host can decide whether to use the PEC byte with the ADM1293/ADM1294 on a message by message basis. There is no need to enable or disable PEC in the ADM1293/ADM1294.

The PEC byte is used by the bus host or the ADM1293/ADM1294 to detect errors during a bus transaction, depending on whether the transaction is a read or a write. If the host determines that the PEC byte read during a read transaction is incorrect, it can decide to repeat the read if necessary. If the ADM1293/ADM1294 determine that the PEC byte sent during a write transaction is incorrect, it ignores the command (does not execute it) and sets a status flag.

Within a group command, the host can choose whether to send a PEC byte as part of the message to the ADM1293/ADM1294.

PARTIAL TRANSACTIONS ON I²C BUS

If there is a partial transaction on the I²C bus, for example, spurious data interpreted as a start command, the ADM1293/ADM1294 I²C bus does not lock up, thinking it is in the middle of an I²C transaction. A new start command is recognized even in the middle of another transaction.

SMBus MESSAGE FORMATS

Figure 30 to Figure 38 show all of the SMBus protocols that are supported by the ADM1293/ADM1294, together with the PEC variant. In these figures, unshaded cells indicate that the bus host is actively driving the bus; shaded cells indicate that the ADM1293/ADM1294 is driving the bus.

Figure 30 to Figure 38 use the following abbreviations:

- S is the start condition.
- Sr is the repeated start condition.
- P is the stop condition.
- R is the read bit.
- W is the write bit.
- A is the acknowledge bit (0).
- Ā is the acknowledge bit (1).

A, the acknowledge bit, is typically active low (Logic 0) if the transmitted byte is successfully received by a device. However, when the receiving device is the bus master, the acknowledge bit for the last byte read is a Logic 1, indicated by Ā.



Figure 30. Send Byte and Send Byte with PEC



Figure 31. Receive Byte and Receive Byte with PEC

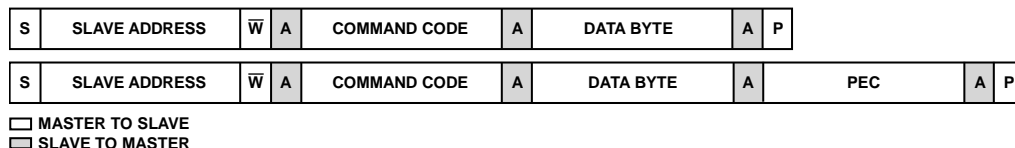

Figure 32. Write Byte and Write Byte with PEC



Figure 33. Read Byte and Read Byte with PEC

11891-033



Figure 34. Write Word and Write Word with PEC

11891-034



Figure 35. Read Word and Read Word with PEC

11891-035



Figure 36. Block Read and Block Read with PEC

11891-036



Figure 37. Group Command

11891-037

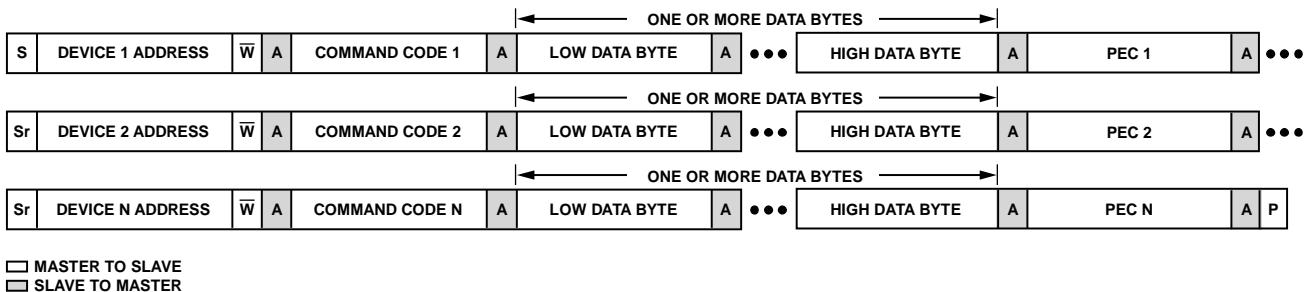

Figure 38. Group Command with PEC

11891-038

GROUP COMMANDS

The PMBus standard defines what are known as group commands. Group commands are single bus transactions that send commands or data to more than one device at the same time. Each device is addressed separately, using its own address; there is no special group command address. A group command transaction can contain only write commands that send data to a device. It is not possible to use a group command to read data from devices.

From an I²C protocol point of view, a normal write command consists of the following:

- I²C start condition
- Slave address bits and a write bit (followed by an acknowledge from the slave device)
- One or more data bytes (each of which is followed by an acknowledge from the slave device)
- I²C stop condition to end the transaction

A group command differs from a nongroup command in that after the data is written to one slave device, a repeated start condition is placed on the bus, followed by the address of the next slave device and data. This continues until all of the devices have been written to, at which point the stop condition is placed on the bus by the master device.

The format of a group command and a group command with PEC is shown in Figure 37 and Figure 38.

Each device that is written to as part of the group command does not immediately execute the command written. The device must wait until the stop condition appears on the bus. At that point, all devices execute their commands at the same time.

Using a group command, it is possible, for example, to turn multiple PMBus devices on or off simultaneously. In the case of the [ADM1293/ADM1294](#), it is also possible to issue a power monitor command that initiates a conversion, causing multiple [ADM1293/ADM1294](#) devices to sample together at the same time.

INFORMATION COMMANDS

CAPABILITY Command

Host processors can use the CAPABILITY command to determine the I²C bus features that are supported by the [ADM1293/ADM1294](#). The features that can be reported include the maximum bus speed, whether the device supports the PEC byte, and the SMBALERT reporting function.

PMBUS_REVISION Command

The PMBUS_REVISION command reports the version of Part I and Part II of the PMBus standard.

MFR_ID, MFR_MODEL, and MFR_REVISION Commands

The MFR_ID, MFR_MODEL, and MFR_REVISION commands return ASCII strings that facilitate detection and identification of the [ADM1293/ADM1294](#) on the bus.

These commands are read using the SMBus block read message type. This message type requires that the [ADM1293/ADM1294](#) return a byte count corresponding to the length of the string data that is to be read back.

STATUS COMMANDS

The [ADM1293/ADM1294](#) provide a number of status bits that are used to report warnings detected. These status bits are located in four different registers that are arranged in a hierarchy. The STATUS_BYTE and STATUS_WORD commands provide 8 bits and 16 bits of high level information, respectively. The STATUS_BYTE and STATUS_WORD commands contain the most important status bits, as well as pointer bits that indicate whether any of the three other status registers must be read for more detailed status information.

Warnings in the [ADM1293/ADM1294](#) are generated from a digital comparison between the power monitor measurements to the threshold values set by the various limit commands. A warning can be used to control the state of the ALERTx output pins, or to generate a SMBALERT interrupt signal through one of the ALERTx pins.

When a status bit is set, it always means that the status condition is active or was active at some point in the past. When a warning bit is set, it is latched until it is explicitly cleared using the CLEAR_FAULTS command. Some other status bits are live, that is, they always reflect a status condition and are never latched.

STATUS_BYTE and STATUS_WORD Commands

The STATUS_BYTE and STATUS_WORD commands can be used to obtain a snapshot of the overall device status. These commands indicate whether it is necessary to read more detailed information using the other status commands.

The low byte of the word returned by the STATUS_WORD command is the same byte returned by the STATUS_BYTE command. The high byte of the word returned by the STATUS_WORD command provides a number of bits that can be used to determine which of the other status commands must be issued to obtain all active status bits.

STATUS_INPUT Command

The STATUS_INPUT command returns a number of bits relating to voltage warnings on the VIN pin as well as the overpower warning.

STATUS_IOUT Command

The STATUS_IOUT command returns a number of bits relating to current warnings on the monitoring rail.

STATUS_MFR_SPECIFIC Command

The STATUS_MFR_SPECIFIC command is a standard PMBus command, but the contents of the byte returned are specific to the [ADM1293/ADM1294](#). It returns a number of bits relating to voltage warnings on the VAUX pin.

CLEAR_FAULTS Command

The CLEAR_FAULTS command clears warnings bits when they are set. Warning bits are latched when they are set. In this way, a host can read the bits any time after the warning condition occurs and determine which problem actually occurred.

If the CLEAR_FAULTS command is issued and the warning condition is no longer active, the status bit is cleared. If the condition is still active—for example, if the input voltage is below the undervoltage threshold of the VIN pin—the CLEAR_FAULTS command attempts to clear the status bit, but that status bit is immediately set again.

GPOX AND ALERTx PIN SETUP COMMANDS

Two multipurpose pins are provided on the [ADM1293/ADM1294](#): GPO1/ALERT1/CONV and GPO2/ALERT2.

These pins can be configured over the PMBus in one of three output modes, as follows:

- General-purpose digital output
- Output for generating an SMBALERT when one or more warning status bits become active in the PMBus status registers
- Digital comparator

In digital comparator mode, the current, voltage, and power warning thresholds are compared to the values read or calculated by the [ADM1293/ADM1294](#). The comparison result sets the output high or low according to whether the value is greater or less than the warning threshold that has been set.

For an example of how to configure these pins to generate an SMBALERT and how to respond and clear the condition, see the Example Use of SMBus ARA section.

ALERT1_CONFIG and ALERT2_CONFIG Commands

Using combinations of bit masks, the ALERT1_CONFIG and ALERT2_CONFIG commands select the status bits that, when set, generate an SMBALERT signal to a processor, or control the digital comparator mode. The GPO1/ALERT1/CONV and GPO2/ALERT2 pins must be configured in SMBALERT or digital comparator mode in the DEVICE_CONFIG register.

If configured in GPO mode, the pin is under software control. If this mode is set, the SMBALERT masking bits are ignored.

POWER MONITOR COMMANDS

The [ADM1293/ADM1294](#) provide a high accuracy, 12-bit current, voltage, and power monitor. The power monitor can be configured in a number of different modes of operation and can run in either continuous mode or single shot mode with a number of different sample averaging options.

The power monitor can measure the following quantities:

- Input voltage (VIN)
- Output current (IOUT)
- Auxiliary input voltage (VAUX)

The following quantities are then calculated:

- Input power (PIN)
- Energy flow in forward direction (EIN)
- Energy flow in reverse direction (EOUT)

PMON_CONFIG Command

The power monitor can run in a number of different modes. The PMON_CONFIG command is used to set up the power monitor.

The settings that can be configured are as follows:

- Single shot or continuous sampling
- VIN/VAUX sampling enable/disable
- Current and voltage sample averaging
- Power sample averaging
- Simultaneous sampling enable/disable
- VIN monitoring range selection
- Current monitoring range selection

Modifying the power monitor settings while the power monitor is sampling is not recommended. To ensure correct operation of the device and to avoid any potential spurious data or the generation of status alerts, stop the power monitor before changing any of these settings.

PMON_CONTROL Command

Power monitor sampling can be initiated via hardware or via software using the PMON_CONTROL command. This command can be used with single shot or continuous mode.

READ_VIN, READ_VAUX, and READ_IOUT Commands

The [ADM1293/ADM1294](#) power monitor always measures the voltage developed across the sense resistor to provide a current measurement. [ADM1293/ADM1294](#) supports bidirectional current monitoring and the data returned by the READ_IOUT command is expressed in twos complement format with the MSB indicating the direction of the current flow. A MSB of 0 indicates positive current flow (from the SENSEP pin to the SENSEN pin), and a MSB of 1 indicates reverse current flow (from the SENSEN pin to the SENSEP pin).

The input voltage measurement from the SENSEP pin is also enabled by default. The auxiliary input voltage present on the VAUX pin is available if enabled with the PMON_CONFIG command.

READ_PIN, READ_PIN_EXT, READ_EIN, and READ_EIN_EXT Commands

The 12-bit VIN input voltage and 12-bit IOUT current measurement values are multiplied by the [ADM1293/ADM1294](#) to give the input power value. This is accomplished by using fixed point arithmetic, and produces a 24-bit value. It is assumed that the numbers are in the 12.0 format, meaning that there is no fractional part.

This 24-bit extended precision power value can be read from the [ADM1293/ADM1294](#) using the READ_PIN_EXT command.

The 16 most significant bits of the 24-bit value can be read using the READ_PIN command.

Similar to READ_IOUT, both the READ_PIN and the READ_PIN_EXT commands are expressed in twos complement format with the MSB indicating the direction of the power flow.

READ_EIN, READ_EIN_EXT, READ_EOUT, and READ_EOUT_EXT Commands

There are two sets of power accumulators inside the [ADM1293/ADM1294](#) to support bidirectional energy metering function.

The forward flowing power data (from the SENSEP pin to the SENSEN pin, with an MSB of 0) is accumulated in the READ_EIN register and the negative flowing power data (from the SENSEN pin to the SENSEP pin, with an MSB of 1) is accumulated in the READ_EOUT register.

Each time a power calculation is performed, the 24-bit power value is added to a corresponding unsigned 24-bit energy accumulator register.

Each time this energy accumulator register rolls over from 0xFFFFF to 0x00000, a 16-bit rollover counter is incremented. The rollover counter is straight binary, with a maximum value of 0xFFFF before it rolls over.

A 24-bit straight binary power sample counter is also incremented by 1 each time a power value is calculated and added to the energy accumulator.

These registers can be read back either in standard data format by the READ_EIN and the READ_EOUT commands, or extended precision data format by the READ_EIN_EXT and the READ_EOUT_EXT commands, depending on the level of accuracy required for the energy accumulator and the desire to limit the frequency of reads from the [ADM1293/ADM1294](#).

A bus host can read these values, and by calculating the delta in the power accumulated, the delta in the number of samples, and the time delta since the last read, the host can calculate the average power since the last read, as well as the energy consumed since the last read.

The time delta is calculated by the bus host based on when it sends its commands to read from the device, and is not provided by the [ADM1293/ADM1294](#).

To avoid data loss, the bus host must read at a rate that ensures the rollover counter does not wrap around more than once, and if the counter does wrap around, that the next value read for P_{IN} is less than the previous one.

The READ_EIN and READ_EOUT commands return the top 16 bits of the energy accumulator, the lower 8 bits of the rollover counter, and the full 24 bits of the sample counter.

The READ_EIN_EXT and READ_EOUT_EXT commands return the full 24 bits of the energy accumulator, the full 16 bits of the rollover counter, and the full 24 bits of the sample counter. The use of the longer rollover counter means that the time interval between reads of the device can be increased from seconds to minutes, without losing any data.

By disabling VIN sampling, a constant value of 1 is assigned to the VIN register. This allows IOUT data to be duplicated in the PIN register, as $PIN = IOUT \times 1 = IOUT$ and transforms the power accumulators to current accumulators/coulomb counters.

READ_EIN and READ_EOUT Commands in the PMBus Standard

The definition and implementation of the READ_EIN and READ_EOUT commands on the [ADM1293/ADM1294](#) devices are slightly different from the ones described in the PMBus Standard. Pay special attention to the differences to avoid a calculation error.

In terms of the definition, the READ_EIN and READ_EOUT commands described in the PMBus standard are used to return the accumulated power values entering and then exiting the PMBus device. Together they allow the host to calculate the power and energy consumption of the PMBus device. This is useful for devices with dynamic power loss such as a dc-to-dc converter.

As dedicated power monitors, the power consumption of the [ADM1293/ADM1294](#) devices is fairly constant and generally very small compared to the power they are trying to monitor. Therefore, instead of monitoring their own power consumption, the READ_EIN and READ_EOUT commands on the [ADM1293/ADM1294](#) are designed to return the accumulated bidirectional power data on the monitored supply rail. They allow the user to calculate the energy flow on the rail in both directions.

As for implementation, the power accumulation data described in the PMBus standard are expressed in signed, 16-bit, twos complement format. The rollover counter increases by 1 each time the energy accumulator register rolls over from 0x7FFF to 0x0000.

The power accumulators on the [ADM1293/ADM1294](#) devices are defined to accumulate power in one specific direction. This removes the need for the sign bit and the power accumulation data on the [ADM1293/ADM1294](#) devices is expressed as an unsigned 16-bit value. As a result, the rollover counter increases by 1 each time the energy accumulator register rolls over from 0xFFFF to 0x0000.

PEAK_VIN, PEAK_VAUX, MIN_IOUT, MAX_IOUT, MIN_PIN, and MAX_PIN Commands

In addition to the standard PMBus commands for reading voltage, current, and power, the [ADM1293/ADM1294](#) provide commands that report the maximum peak voltage, the maximum and minimum current, and the power values recorded.

The [ADM1293/ADM1294](#) devices support bidirectional current and power monitoring. Both current and power data are expressed in twos complement format with the MSB being the sign bit indicating the direction of the current/power flow. For current and power, the maximum values are defined as the most positive values recorded (flowing from the SENSEP pin to the SENSEN pin) or least negative values recorded (flowing from the SENSEN pin to the SENSEP pin), and the minimum values are defined as the most negative or least positive values recorded. For example, if the current readback ranges between 3 A and 5 A, the MAX_IOUT command returns 5 A and the MIN_IOUT command returns 3 A. If the current readback ranges between -3 A and -5 A, the MAX_IOUT command returns -3 A and the MIN_IOUT command returns -5 A.

These peak values are updated only after the power monitor has sampled and averaged the current and voltage measurements. Individual peak values are cleared by writing a value of 0 with the corresponding command.

WARNING LIMIT SETUP COMMANDS

The [ADM1293/ADM1294](#) power monitor can monitor a number of different warning conditions simultaneously and report any current, voltage, or power values that exceed the user defined thresholds using the status commands.

All comparisons performed by the power monitor require the measured value to be strictly greater or less than the threshold value.

At power-up, all threshold limits are set to either minimum scale (for undervoltage conditions) or to maximum scale (for overvoltage, overcurrent, or overpower conditions). This effectively disables the generation of any status warnings by default; warning bits are not set in the status registers until the user explicitly sets the threshold values.

VIN_OV_WARN_LIMIT and VIN_UV_WARN_LIMIT Commands

The VIN_OV_WARN_LIMIT and VIN_UV_WARN_LIMIT commands set the overvoltage (OV) and undervoltage (UV) thresholds on the input voltage, as measured at the VIN pin.

VAUX_OV_WARN_LIMIT and VAUX_UV_WARN_LIMIT Commands

The VAUX_OV_WARN_LIMIT and VAUX_UV_WARN_LIMIT commands set the OV and UV thresholds on the output voltage, as measured at the VAUX pin.

IOUT_OC_WARN_LIMIT Command

The IOUT_OC_WARN_LIMIT command sets the overcurrent threshold for the current flowing through the sense resistor.

If the threshold is a positive value, a more positive current measurement value is required to trigger the overcurrent warning. If the threshold is a negative value, a more negative current measurement value is required to trigger the overcurrent warning.

PIN_OP_WARN_LIMIT Command

The PIN_OP_WARN_LIMIT command sets the overpower threshold for the power that appears on the rail being monitored.

If the threshold is a positive value, a more positive power measurement value is required to trigger the overpower warning. If the threshold is a negative value, a more negative power measurement value is required to trigger the overpower warning.

PMBus DIRECT FORMAT CONVERSION

The [ADM1293/ADM1294](#) uses the PMBus direct format to represent real-world quantities such as voltage, current, and power values. A direct format number takes the form of a 2-byte, twos complement, binary integer value.

It is possible to convert between direct format value and real-world quantities using the following equations. Equation 1 converts from real-world quantities to PMBus direct values, and Equation 2 converts PMBus direct format values to real-world values.

$$Y = (mX + b) \times 10^R \quad (1)$$

$$X = 1/m \times (Y \times 10^{-R} - b) \quad (2)$$

where:

Y is the value in PMBus direct format.

X is the real-world value.

m is the slope coefficient, a 2-byte, twos complement integer.

b is the offset, a 2-byte, twos complement integer.

R is a scaling exponent, a 1-byte, twos complement integer.

The same equations are used for voltage, current, and power conversions (with the exception of accumulated power conversion), the only difference being the values of the m, b, and R coefficients that are used. Table 10 lists all the coefficients required for the [ADM1293/ADM1294](#). The current and power coefficients shown are dependent on the value of the external sense resistor used in a given application. This means that an additional calculation must be performed to take the sense resistor value into account to obtain the coefficients for a specific sense resistor value.

Table 10. PMBus Conversion to Real-World Coefficients

Coefficients	Voltage Range (V) ¹	Current Sense Range (mV) ¹	m ²	b	R
Voltage (V)	0 to 1.2	N/A	3333	-1	0
	0 to 7.4	N/A	5552	-5	-1
	0 to 21	N/A	19,604	-50	-2
Current (A)	N/A	±25	8000 × R _{SENSE}	-100	-2
	N/A	±50	4000 × R _{SENSE}	-100	-2
	N/A	±100	20,000 × R _{SENSE}	-1000	-3
	N/A	±200	10,000 × R _{SENSE}	-1000	-3
Power (W)	0 to 1.2	±25	10,417 × R _{SENSE}	0	-1
	0 to 1.2	±50	5208 × R _{SENSE}	0	-1
	0 to 1.2	±100	26,042 × R _{SENSE}	0	-2
	0 to 1.2	±200	13,021 × R _{SENSE}	0	-2
	0 to 7.4	±25	17,351 × R _{SENSE}	0	-2
	0 to 7.4	±50	8676 × R _{SENSE}	0	-2
	0 to 7.4	±100	4338 × R _{SENSE}	0	-2
	0 to 7.4	±200	21,689 × R _{SENSE}	0	-3
	0 to 21	±25	6126 × R _{SENSE}	0	-2
	0 to 21	±50	30,631 × R _{SENSE}	0	-3
	0 to 21	±100	15,316 × R _{SENSE}	0	-3
	0 to 21	±200	7658 × R _{SENSE}	0	-3

¹ N/A means not applicable.

² The sense resistor value, used in the calculations to obtain the coefficients, is expressed in milliohms.

The sense resistor value used in the calculations to obtain the coefficients is expressed in milliohms. The m coefficients are defined as 2-byte twos complement numbers in the PMBus standard; therefore, the maximum positive value that can be represented is 32,767. If the m value is greater than that, and is to be stored in PMBus standard form, then divide the m coefficients by 10, and increase the R coefficient by a value of 1. For example, if a 10 mΩ sense resistor is used, the m coefficient for power is 6123, and the R coefficient is -1.

Example 1: IOUT_OC_WARN_LIMIT requires a current-limit value expressed in direct format.

Assume the current sense range is 25 mV. If the required current limit is 10 A and the sense resistor is 2 mΩ, the first step is to determine the voltage coefficient. This is $m = 8000 \times 2$, giving 16,000.

Using Equation 1, and expressing X in units of amperes,

$$Y = ((16,000 \times 10) - 100) \times 10^{-2}$$

$$Y = 1599$$

Writing a value of 1599 with the IOUT_OC_WARN_LIMIT command sets an overcurrent warning at 10 A.

Example 2: IOUT_OC_WARN_LIMIT requires a current-limit value expressed in direct format.

Assume the current sense range is 25 mV. If the required current limit is -10 A and the sense resistor is 2 mΩ, the first step is to determine the voltage coefficient. This is $m = 8000 \times 2$, giving 16,000.

Using Equation 1, and expressing X in units of amperes,

$$Y = ((16,000 \times -10) - 100) \times 10^{-2}$$

$$Y = -1601 = (\text{signed 16 bits}) 0xF9BF = (\text{unsigned}) 63935d$$

Writing a value of 63935d with the IOUT_OC_WARN_LIMIT command sets an overcurrent warning at -10 A.

Example 3: the READ_IOUT command returns a direct format value of 125, representing the current flowing through a sense resistor of 1 mΩ. The current sense range is 50 mV.

To convert this value to the current flowing, use Equation 2, with $m = 4000 \times 1$.

$$X = 1/4000 \times (125 \times 10^2 + 100)$$

$$X = 3.15 \text{ A}$$

This means that when READ_IOUT returns a value of 125, 3.15 A is flowing in the sense resistor. A positive values means the current is flowing in the forward direction from the SENSEP pin to the SENSEN pin.

Example 4: the READ_PIN command returns a direct format value of 12,635, representing the power measured through a sense resistor of 0.25 mΩ. The voltage range is 0 V to 21 V and the current sense range is 0 mV to 25 mV.

To convert this value to the current flowing, use Equation 2, with $m = 6126 \times 0.25 = 1531.5$

$$X = 1/1531.5 \times (12635 \times 10^2 - 0)$$

$$X = 825 \text{ W}$$

This means that, when READ_PIN returns a value of 12,635, 825 W is being delivered on the rail.

Note that the READ_PIN_EXT command returns the 24-bit extended precision versions of the 16-bit values returned by the READ_PIN command. The direct format values must be divided by 256 before being converted with the coefficients shown in Table 10.

ENERGY METER VALUE CONVERSION

On the ADM1293 and ADM1294, the accumulated power value in the energy metering registers is stored as an unsigned integer. The total energy accumulated can be derived by treating the rollover count value as the most significant extension to the power accumulator value.

Example 1: The READ_EIN command has been issued to an ADM1293 or ADM1294 device twice by a processor with 1000 ms in between reads.

The data returned from the first read is

- SAMPLE_COUNT: 0x004000
- EIN_ROLLOVER_COUNT: 0x1A
- EIN_ENERGY_COUNT: 0x02FE

The data returned from the second read is

- SAMPLE_COUNT: 0x00602C
- EIN_ROLLOVER_COUNT: 0xF8
- EIN_ENERGY_COUNT: 0x2FDC

The sense resistor is 0.25 mΩ, the voltage range is 0 V to 21 V, and the current sense range is 0 mV to 25 mV. Assuming the rollover counter did not roll over between the two reads, the processor is required to determine the energy consumption on the rail being monitored during this time.

Start by determining the total power accumulated in the energy meter register at each read. By treating the rollover count value as the most significant extension to the power accumulator value, the total power accumulated at the first read is 0x1A02FE. Similarly, the total power accumulated at the second read is 0xF82FDC. The power delta between the two reads is

$$0xF82FDC - 0x1A02FE = 0xDE2CDE$$

And the sample count delta is

$$0x00602C - 0x004000 = 0x202C$$

The average power per sample between the two reads is

$$0xDE2CDE/0x202C = 0x6E7 = 1767d$$

To convert this to a real-world value, the first step is to determine the m coefficient, that is, $m = 6126 \times 0.25 = 1531.5$.

Using Equation 2

$$X = 1/1531.5 \times (1767 \times 10^2 - 0)$$

$$X = 115.38 \text{ W}$$

The energy consumed between the two reads is equal to the average power by time.

$$\text{Energy} = 115.38 \text{ W} \times 1 \text{ sec} = 115.38 \text{ J}$$

On the ADM1293-2 and ADM1294-2, the accumulated power value in the energy metering registers is presented in twos complement format as defined in the PMBus standard.

Example 2: The READ_EIN command has been issued to an ADM1293-2 or ADM1294-2 device twice by a processor with 1000 ms in between reads.

The data returned from the first read is

- SAMPLE_COUNT: 0x004000
- EIN_ROLLOVER_COUNT: 0x1A
- EIN_ENERGY_COUNT: 0x02FE

The data returned from the second read is

- SAMPLE_COUNT: 0x00602C
- EIN_ROLLOVER_COUNT: 0xF8
- EIN_ENERGY_COUNT: 0x2FDC

The sense resistor is 0.25 mΩ, the voltage range is 0 V to 21 V, and the current sense range is 0 mV to 25 mV. Assuming the rollover counter did not roll over between the two reads, the processor is required to determine the energy consumption on the rail being monitored during this time.

Start by determining the total power accumulated in the energy meter register at each read.

$$\text{Total Power} = \text{RolloverCount} \times \text{MaximumEnergyCount} + \text{EnergyCount}$$

Where the maximum energy count is the maximum value of the energy count register before roll over happens. And for the ADM1293-2 and ADM1294-2, the maximum energy count is 0x7FFF.

The total power accumulated at the time of the first read is

$$0x1A \times 0x7FFF + 0x02FE = 0xD02E4$$

The total power accumulated at the time of the second read is

$$0xF8 \times 0x7FFF + 0x2FDC = 0x7C2EE4$$

The power delta between the two reads is

$$0x7C2EE4 - 0xD02E4 = 0x6F2C00$$

And the sample count delta is

$$0x00602C - 0x004000 = 0x202C$$

The average power per sample between the two reads is

$$0x6F2C00 \div 0x202C = 0x374 = 884d$$

To convert this to a real-world value, the first step is to determine the m coefficient, that is, $m = 6126 \times 0.25 = 1531.5$.

Using Equation 2

$$X = 1/1531.5 \times (884 \times 10^2 - 0)$$

$$X = 57.72 \text{ W}$$

The energy consumed between the two reads is equal to the average power by time.

$$\text{Energy} = 57.72 \text{ W} \times 1 \text{ sec} = 57.72 \text{ J}$$

ENERGY METER VALUE TO PMBus STANDARD DATA CONVERSION

Although the energy meter function on the [ADM1293-1/ADM1294-1](#) devices is implemented differently to the PMBus standard, some simple data preprocessing steps can be added to the processor firmware if the user wants to use the same software code written for the PMBus standard EIN_READ and EOUT_READ commands with the [ADM1293-1/ADM1294-1](#) devices. The two data preprocessing steps are

1. Treating ENERGY_COUNT as an unsigned integer.
2. Multiply ROLLOVER_COUNT by 2.

VOLTAGE AND CURRENT CONVERSION USING LSB VALUES

The direct format voltage and current values returned by the READ_VIN, READ_VAUX, and READ_IOUT commands and the corresponding peak versions are the data output directly by the [ADM1293/ADM1294](#) ADCs. Because the voltages and currents are 12-bit ADC output codes, they can also be converted to real-world values when there is knowledge of the size of the LSB on the ADC.

The m, b, and R coefficients defined for the PMBus conversion are required to be whole integers by the standard and have, therefore, been rounded slightly. Using this alternative method,

with the exact LSB values, somewhat more accurate numerical conversions can be provided.

To convert an ADC code to current in amperes, use the following formulas:

$$V_{SENSE} = LSB_{CURRENT} \times (I_{ADC} + 1)$$

$$I_{OUT} = \frac{V_{SENSE}}{R_{SENSE}}$$

where:

$$V_{SENSE} = V_{SENSEP} - V_{SENSEN}$$

$LSB_{CURRENT}$ is the size of the current sense voltage LSB for a given current sense range.

I_{ADC} is the 12-bit ADC code.

I_{OUT} is the measured current value in amperes.

R_{SENSE} is the value of the sense resistor in ohms.

To convert an ADC code to a voltage, use the following formula:

$$V_M = LSB_{VOLTAGE} \times (V_{ADC} + 0.5)$$

where:

V_M is the measured value in volts.

$LSB_{VOLTAGE}$ is the size of the voltage sensing LSB for a given input voltage range.

V_{ADC} is the 12-bit ADC code.

Table 11. LSB Values

LSB Type	Voltage Range (V) ¹	Current Sense Range (mV) ¹	LSB Value
LSB Voltage (mV)	0 to 1.2	N/A	0.3
	0 to 7.4	N/A	1.801
	0 to 21	N/A	5.101
LSB Current Sensing (μV)	N/A	±25	12.5
	N/A	±50	25
	N/A	±100	50
	N/A	±200	100

¹ N/A means not applicable.

ALERT_x PIN BEHAVIOR

WARNINGS

The sources of a warning are defined as follows:

- CML, a communications error occurred on the I²C bus
- IOUT OC warning from the ADC
- VIN UV warning from the ADC
- VIN OV warning from the ADC
- VAUX UV warning from the ADC
- VAUX OV warning from the ADC
- PIN overpower (OP) warning from the VIN × IOUT calculation
- Hysteretic output warning from the ADC

A value of 1 in a status register bit field always indicates a warning condition. Warning bits in the status registers are latched when set to 1. Use the CLEAR_FAULTS command to clear a latched bit to 0.

GENERATING AN ALERT

A host device can periodically poll the [ADM1293/ADM1294](#) using the status commands to determine whether a warning is active. However, this polling is very inefficient in terms of software and processor resources. The [ADM1293/ADM1294](#) have two output pins (GPO1/ALERT1/CONV and GPO2/ALERT2) that can be used to generate interrupts to a host processor.

By default at power-up, the open-drain GPO1/ALERT1/CONV and GPO2/ALERT2 outputs are high impedance; therefore, the pins can be pulled high through a resistor. The GPO1/ALERT1/CONV and GPO2/ALERT2 pins are disabled by default on the [ADM1293/ADM1294](#).

Any one or more of the warnings listed in the Warnings section can be enabled and cause an alert, making the corresponding GPO1/ALERT1/CONV or GPO2/ALERT2 pin active. By default, the active state of the GPO1/ALERT1/CONV and GPO2/ALERT2 pins are low.

For example, to use GPO2/ALERT2 to monitor the VAUX UV warning from the ADC, the followings steps must be performed:

3. Set a threshold level with the VAUX_UV_WARN_LIMIT command.
4. Set the VAUX_UV_WARN_EN2 bit in the ALERT2_CONFIG register.
5. Start the power monitor sampling on VAUX. Ensure the power monitor is configured to sample VAUX in the PMON_CONFIG register.

If a VAUX sample is taken that is below the configured VAUX UV value, the GPO2/ALERT2 pin is pulled low, signaling an interrupt to a processor.

HANDLING/CLEARING AN ALERT

When warnings are configured on the GPO1/ALERT1/CONV or GPO2/ALERT2 pins, the pin becomes active to signal an interrupt to the processor. The pin is active low, unless inversion is enabled. The GPO1/ALERT1/CONV or GPO2/ALERT2 signal performs the functions of an SMBALERT.

Note that the GPO1/ALERT1/CONV and GPO2/ALERT2 pins can become active independently but they are always made inactive together.

A processor can respond to the interrupt in one of two ways.

- If only one device is on the bus, the processor can read the status bytes and issue a CLEAR_FAULTS command to clear all the status bits, which causes the deassertion of the GPO1/ALERT1/CONV or GPO2/ALERT2 line. If the cause of the SMBALERT is a power monitor generated warning and that warning persists, providing the power monitor is running continuously, the next sample generates a new SMBALERT after the CLEAR_FAULTS command is issued.
- If there are several devices on the bus, the processor can issue an SMBus alert response address (ARA) command to find out which device asserted the SMBALERT line. The processor can read the status bytes from that device and issue a CLEAR_FAULTS command.

SMBus ALERT RESPONSE ADDRESS (ARA)

The SMBus ARA is a special address that is used by the bus host to locate any devices that need to communicate with the bus host. A host typically uses a hardware interrupt pin to monitor the SMBus alert pins of multiple devices. When the host interrupt occurs, the host issues a message on the bus using the SMBus receive byte or receive byte with PEC protocol.

The special address used by the host is 0x0C. Any devices that have an SMBALERT signal return their own 7-bit address as the seven MSBs of the data byte. The LSB value is not used and can be either 1 or 0. The host reads the device address from the received data byte and proceeds to handle the alert condition.

More than one device may have an active SMBALERT signal and attempt to communicate with the host. In this case, the device with the lowest address dominates the bus and succeeds in transmitting its address to the host. The device that succeeds disables its SMBus alert signal. If the host sees that the SMBus alert signal is still low, it continues to read addresses until all devices that need to communicate have successfully transmitted their addresses.

EXAMPLE USE OF SMBus ARA

The full sequence of steps that occurs when an SMBALERT is generated and cleared is as follows:

1. A warning is enabled using the ALERT2_CONFIG command, and the corresponding status bit for the warning changes from 0 to 1, indicating that the warning has recently become active.
2. The GPO2/ALERT2 pin becomes active (set low) to signal that an SMBALERT is active.
3. The host processor issues an SMBus ARA command to determine which device has an active alert.
4. If there are no other active alerts from devices with lower I²C addresses, this device makes the GPO2/ALERT2 pin inactive (set high) during the no acknowledge bit period after it sends its address to the host processor.
5. If the GPO2/ALERT2 pin stays low, the host processor must continue to issue SMBus ARA commands to devices to determine the addresses of all devices whose status it must check.
6. The ADM1293/ADM1294 continue to operate with the GPO2/ALERT2 pin inactive and the contents of the status bytes unchanged until the host reads the status bytes and clears them, or until a new fault occurs. That is, if a status bit for a fault or warning that is enabled on the GPO2/ALERT2 pin and that was not already active (equal to 1) changes from 0 to 1, a new alert is generated, causing the GPO2/ALERT2 pin to become active again.

DIGITAL COMPARATOR MODE

The GPO1/ALERT1/CONV and GPO2/ALERT2 pins can be configured to indicate if a user defined threshold for voltage, current, or power is being exceeded. In this mode, the output pin is live and is not latched when a warning threshold is exceeded. In effect, the pin acts as a digital comparator, where the threshold is set using the warning limit threshold commands.

The ALERTx_CONFIG command is used, similar to the SMBALERT configuration, to select the specific warning threshold to be monitored. The GPO1/ALERT1/CONV or GPO2/ALERT2 pin then indicates if the measured value is above or below the threshold.

APPLICATION DIAGRAMS

Figure 39 shows an example application circuit of the ADM1293. With different address pin configurations, up to 16 ADM1293 devices can share the same I²C bus and are controlled by the same bus master. Each device can be used to monitor a supply rail with a voltage ranging from 0 V to 20 V and report voltage, current, power, and energy consumption. Each device can also monitor one additional node on the system using the VAUX input and report the voltage value present on the node.

The multifunction pins can be configured to indicate status warnings generated by the ADM1293 either to the microprocessor or directly to the user by driving a LED. These pins can also be configured as an ADC conversion signal input to allow synchronized voltage and current sampling across the system.



¹ALERT2 IS THE ACTIVE PIN FUNCTION IN THIS SETUP.
²CONV IS THE ACTIVE PIN FUNCTION IN THIS SETUP.

Figure 39. ADM1293 Typical Application Diagram

11891-039

Figure 40 shows an example application circuit of the ADM1294. Two of the devices shown are used to monitor a 300 V supply rail and a -48 V supply rail. Both of the devices communicate with the master device across an isolation barrier. Separated SDA lines make it easy to set up the bidirectional communication across the isolation barrier with optocouplers. The internal shunt regulator allows the ADM1294 to be

powered directly from a wide range of supply voltages. The ADM3260 I²C and power isolator are used with another ADM1294. The I²C and power isolator not only greatly simplifies the cross isolation communication design, but also can be used to provide power to the ADM1294 and other circuits on the primary side.



¹GPO2 IS THE ACTIVE PIN FUNCTION IN THIS SETUP.
²ALERT1 IS THE ACTIVE PIN FUNCTION IN THIS SETUP.
³ALERT2 IS THE ACTIVE PIN FUNCTION IN THIS SETUP.
⁴CONV IS THE ACTIVE PIN FUNCTION IN THIS SETUP.

Figure 40. ADM1294 Typical Application Diagram

1189F-040

PMBus COMMAND REFERENCE

Register addresses are in hexadecimal format.

Table 12. PMBus Commands Summary

Address	Name	Description	Reset	RW
0x03	CLEAR_FAULTS	Clear faults	Not applicable	W
0x19	CAPABILITY	PMBus capability	0xB0	R
0x4A	IOUT_OC_WARN_LIMIT	IOUT OC warning limit	0x07FF	RW
0x57	VIN_OV_WARN_LIMIT	VIN OV warning limit	0x0FFF	RW
0x58	VIN_UV_WARN_LIMIT	VIN UV warning limit	0x0000	RW
0x6B	PIN_OP_WARN_LIMIT	PIN OP warning limit	0x7FFF	RW
0x78	STATUS_BYTE	Status byte	0x00	R
0x79	STATUS_WORD	Status word	0x0000	R
0x7B	STATUS_IOUT	IOUT status	0x00	R
0x7C	STATUS_INPUT	Input status	0x00	R
0x80	STATUS_MFR_SPECIFIC	Manufacturer specific status	0x00	R
0x86	READ_EIN	Read EIN	0x000000000000	R
0x87	READ_EOUT	Read EOUT	0x000000000000	R
0x88	READ_VIN	Read VIN	0x0000	R
0x8C	READ_IOUT	Read IOUT	0x0000	R
0x97	READ_PIN	Read PIN	0x0000	R
0x98	PMBUS_REVISION	PMBus revision	0x22	R
0x99	MFR_ID	Manufacturer ID	0x494441	R
0x9A	MFR_MODEL	Manufacturer model		R
0x9B	MFR_REVISION	Manufacturer revision	0x32	R
0xD0	MAX_IOUT	Maximum IOUT	0xF800	R
0xD1	PEAK_VIN	Peak VIN	0x0000	R
0xD2	PEAK_VAUX	Peak VAUX	0x0000	R
0xD3	PMON_CONTROL	Power monitor control	0x01	RW
0xD4	PMON_CONFIG	Power monitor configuration	0x0714	RW
0xD5	ALERT1_CONFIG	Alert 1 configuration	0x0000	RW
0xD6	ALERT2_CONFIG	Alert 2 configuration	0x0000	RW
0xD8	DEVICE_CONFIG	Device configuration	0x0000	RW
0xDA	MAX_PIN	Maximum PIN	0x8000	R
0xDB	READ_PIN_EXT	Read PIN (extended)	0x000000	R
0xDC	READ_EIN_EXT	Read EIN (extended)	0x0000000000000000	R
0xDD	READ_VAUX	Read VAUX	0x0000	R
0xDE	VAUX_OV_WARN_LIMIT	VAUX OV warning limit	0x0FFF	RW
0xDF	VAUX_UV_WARN_LIMIT	VAUX UV warning limit	0x0000	RW
0xE3	MIN_IOUT	Minimum IOUT	0x7FF	R
0xE4	MIN_PIN	Minimum PIN	0x7FFF	R
0xE5	READ_EOUT_EXT	Read EOUT (extended)	0x0000000000000000	R
0xF2	HYSTERESIS_LOW	Hysteresis low threshold level	0x8000	RW
0xF3	HYSTERESIS_HIGH	Hysteresis high threshold level	0x7FFF	RW
0xF4	STATUS_HYSTERESIS	Hysteresis status	0x00	R

PMBus COMMAND DESCRIPTIONS

CLEAR FAULTS REGISTER

Address: 0x03, Reset: 0x, Name: CLEAR_FAULTS

The CLEAR_FAULTS command clears fault and warning bits in all the status registers. All faults and warnings are cleared, but may be asserted again if it remains active following the next power monitor conversion cycle or bus communication.

This command does not require any data.

PMBus CAPABILITY REGISTER

Address: 0x19, Reset: 0xB0, Name: CAPABILITY

The CAPABILITY command allows the host system to determine the SMBus interface capabilities of the device.

Table 13. Bit Descriptions for CAPABILITY

Bits	Bit Name	Settings	Description	Reset	Access
7	PEC_SUPPORT	1	Packet error correction (PEC) support. Always reads as 1. PEC is supported.	0x1	R
[6:5]	MAX_BUS_SPEED	01	Maximum bus interface speed. Always reads as 01. Maximum supported bus speed is 400 kHz.	0x1	R
4	SMBALERT_SUPPORT	1	SMBALERT support. Always reads as 1. Device supports SMBALERT and the alert response address (ARA).	0x1	R
[3:0]	RESERVED		Always reads as 0000b.	0x0	Reserved

IOUT OC WARNING LIMIT REGISTER

Address: 0x4A, Reset: 0x07FF, Name: IOUT_OC_WARN_LIMIT

The IOUT_OC_WARN_LIMIT command sets the overcurrent warning limit for the current measured between the SENSEP and the SENSEN pins. If the warning limit is a positive number, an overcurrent condition is triggered by a more positive current readback. If the warning limit is a negative number, an overcurrent condition is triggered by a more negative current readback.

Table 14. Bit Descriptions for IOUT_OC_WARN_LIMIT

Bits	Bit Name	Settings	Description	Reset	Access
[15:12]	RESERVED		Always reads as 0000b.	0x0	Reserved
[11:0]	IOUT_OC_WARN_LIMIT		Overcurrent warning threshold for the IOUT measurement, expressed in direct format. Set to default value to disable.	0x7FF	RW

VIN OV WARNING LIMIT REGISTER

Address: 0x57, Reset: 0x0FFF, Name: VIN_OV_WARN_LIMIT

The VIN_OV_WARN_LIMIT command sets the overvoltage warning limit for the voltage measured on the VIN pin.

Table 15. Bit Descriptions for VIN_OV_WARN_LIMIT

Bits	Bit Name	Settings	Description	Reset	Access
[15:12]	RESERVED		Always reads as 0000b.	0x0	Reserved
[11:0]	VIN_OV_WARN_LIMIT		Overvoltage warning threshold for the VIN pin measurement, expressed in direct format. Set these bits to the default value to disable.	0xFFF	RW

VIN UV WARNING LIMIT REGISTER

Address: 0x58, Reset: 0x0000, Name: VIN_UV_WARN_LIMIT

The VIN_UV_WARN_LIMIT command sets the undervoltage warning limit for the voltage measured on the VIN pin.

Table 16. Bit Descriptions for VIN_UV_WARN_LIMIT

Bits	Bit Name	Settings	Description	Reset	Access
[15:12]	RESERVED		Always reads as 0000b.	0x0	Reserved
[11:0]	VIN_UV_WARN_LIMIT		Undervoltage warning threshold for the VIN pin measurement, expressed in direct format. Set these bits to the default value to disable.	0x000	RW

PIN OP WARNING LIMIT REGISTER

Address: 0x6B, Reset: 0x7FFF, Name: PIN_OP_WARN_LIMIT

The PIN_OP_WARN_LIMIT command sets the overpower warning limit for the calculated power value.

If the warning limit is a positive number, an overpower condition is triggered by a more positive power readback. If the warning limit is a negative number, an overpower condition is triggered by a more negative power readback.

Table 17. Bit Descriptions for PIN_OP_WARN_LIMIT

Bits	Bit Name	Settings	Description	Reset	Access
[15:0]	PIN_OP_WARN_LIMIT		Overpower warning threshold for the calculated power, expressed in direct format. Set these bits to the default value to disable.	0x7FFF	RW

STATUS BYTE REGISTER

Address: 0x78, Reset: 0x00, Name: STATUS_BYTE

The STATUS_BYTE command provides status information for communication fault and certain top level status commands in the device. This is also the lower byte returned by STATUS_WORD. A bit set to 1 indicates a fault or warning has occurred.

Table 18. Bit Descriptions for STATUS_BYTE

Bits	Bit Name	Settings	Description	Reset	Access
[7:2]	RESERVED		Always reads as 000000b.	0x00	Reserved
1	CML_FAULT	0 1	Communication fault. This bit is latched. No communications error detected on the I ² C/PMBus interface. An error was detected on the I ² C/PMBus interface. Errors detected are unsupported command, invalid PEC byte, and incorrectly structured message.	0x0	R
0	NONEABOVE_STATUS	0 1	None of the above. This bit is live. No other active status bit reported by any other status command. Active status bits are waiting to be read by one or more status commands.	0x0	R

STATUS WORD REGISTER

Address: 0x79, Reset: 0x0000, Name: STATUS_WORD

The STATUS_WORD command provides status information for communication faults and all top level status commands in the device. The lower byte is also returned by STATUS_BYTE.

Table 19. Bit Descriptions for STATUS_WORD

Bits	Bit Name	Settings	Description	Reset	Access
15	RESERVED		Always reads as 0.	0x0	Reserved
14	IOUT_STATUS	0 1	IOUT warning. This bit is live. There are no active status bits to be read by STATUS_IOUT. There are one or more active status bits to be read by STATUS_IOUT.	0x0	R

Bits	Bit Name	Settings	Description	Reset	Access
13	INPUT_STATUS	0 1	Input warning. This bit is live. There are no active status bits to be read by STATUS_INPUT. There are one or more active status bits to be read by STATUS_INPUT.	0x0	R
12	MFR_STATUS	0 1	Manufacturer specific warnings. This bit is live. There are no active status bits to be read by STATUS_MFR_SPECIFIC. There are one or more active status bits to be read by STATUS_MFR_SPECIFIC.	0x0	R
[11:8]	RESERVED		Always reads as 0000b.	0x0	Reserved
[7:2]	RESERVED		Duplicate of corresponding bit in STATUS_BYTE.	0x00	Reserved
1	CML_FAULT		Duplicate of corresponding bit in STATUS_BYTE.	0x0	R
0	NONEABOVE_STATUS		Duplicate of corresponding bit in STATUS_BYTE.	0x0	R

IOUT STATUS REGISTER

Address: 0x7B, Reset: 0x00, Name: STATUS_IOUT

The STATUS_IOUT command provides status information for warnings related to the IOUT current being monitored.

Table 20. Bit Descriptions for STATUS_IOUT

Bits	Bit Name	Settings	Description	Reset	Access
[7:6]	RESERVED		Always reads as 00b.	0x0	Reserved
5	IOUT_OC_WARN	0 1	IOUT overcurrent warning. No overcurrent condition on the output supply was detected by the power monitor using the IOUT_OC_WARN_LIMIT command. An overcurrent condition was detected by the power monitor using the IOUT_OC_WARN_LIMIT command. This bit is latched.	0x0	R
[4:0]	RESERVED		Always reads as 00000b.	0x00	Reserved

INPUT STATUS REGISTER

Address: 0x7C, Reset: 0x00, Name: STATUS_INPUT

The STATUS_INPUT command provides status information for warnings related to VIN and PIN.

Table 21. Bit Descriptions for STATUS_INPUT

Bits	Bit Name	Settings	Description	Reset	Access
7	RESERVED		Always reads as 0.	0x0	Reserved
6	VIN_OV_WARN	0 1	VIN overvoltage warning. No overvoltage condition on the VIN pin was detected by the power monitor using the VIN_OV_WARN_LIMIT command. An overvoltage condition on the VIN pin was detected by the power monitor using the VIN_OV_WARN_LIMIT command. This bit is latched.	0x0	R
5	VIN_UV_WARN	0 1	VIN undervoltage warning. No undervoltage condition on the VIN pin was detected by the power monitor using the VIN_UV_WARN_LIMIT command. An undervoltage condition on the VIN pin was detected by the power monitor using the VIN_UV_WARN_LIMIT command. This bit is latched.	0x0	R
[4:1]	RESERVED		Always reads as 0000b.	0x0	Reserved
0	PIN_OP_WARN	0 1	PIN overpower warning. No overpower condition on the input supply detected by the power monitor using the PIN_OP_WARN_LIMIT command. An overpower condition on the input supply was detected by the power monitor using the PIN_OP_WARN_LIMIT command. This bit is latched.	0x0	R

MANUFACTURER SPECIFIC STATUS REGISTER

Address: 0x80, Reset: 0x00, Name: STATUS_MFR_SPECIFIC

The STATUS_MFR_SPECIFIC command provides status information for manufacturer specific faults and warnings.

Table 22. Bit Descriptions for STATUS_MFR_SPECIFIC

Bits	Bit Name	Settings	Description	Reset	Access
7	RESERVED		Always reads as 0.	0x0	Reserved
6	VAUX_OV_WARN	0 1	VAUX overvoltage warning. No overvoltage condition was detected on the VAUX pin by the power monitor using the VAUX_OV_WARN_LIMIT command. An overvoltage condition was detected on the VAUX pin by the power monitor using the VAUX_OV_WARN_LIMIT command. This bit is latched.	0x0	R
5	VAUX_UV_WARN	0 1	VAUX undervoltage warning. No undervoltage condition was detected on the VAUX pin by the power monitor using the VAUX_UV_WARN_LIMIT command. An undervoltage condition was detected on the VAUX pin by the power monitor using the VAUX_UV_WARN_LIMIT command. This bit is latched.	0x0	R
[4:0]	RESERVED		Always reads as 00000b.	0x00	Reserved

READ EIN REGISTER

Address: 0x86, Reset: 0x000000000000, Name: READ_EIN

The READ_EIN command reads the forward flow energy meter registers in a single operation to ensure time consistent data. READ_EIN accumulates power data when IOUT is positive.

Table 23. Bit Descriptions for READ_EIN

Bits	Bit Name	Settings	Description	Reset	Access
[47:24]	SAMPLE_COUNT		This is the total number of PIN samples acquired and accumulated in both the forward flow and reverse flow energy count accumulator. Byte 5 is the high byte, Byte 4 is the middle byte, and Byte 3 is the low byte.	0x000000	R
[23:16]	EIN_ROLLOVER_COUNT		Number of times that the forward flow energy count has rolled over. On the ADM1293-1 and ADM1294-1 , the rollover counter increases by 1 each time the energy count rolls over from 0xFFFF to 0x0000. On the ADM1293-2 and ADM1294-2 , the rollover counter increases by 1 each time the energy count rolls over from 0x7FFF to 0x0000. This is an unsigned 8-bit binary value.	0x00	R
[15:0]	EIN_ENERGY_COUNT		Forward flow energy accumulator value in direct format. Byte 1 is the high byte, and Byte 0 is the low byte. On the ADM1293-1 and ADM1294-1 devices, the data is presented as unsigned integer. On the ADM1293-2 and ADM1294-2 devices, the data is presented in two's complement format. Internally, the energy accumulator is a 24-bit value, but only the most significant 16 bits are returned with this command. Use the READ_EIN_EXT to access the nontruncated version.	0x0000	R

READ EOUT REGISTER

Address: 0x87, Reset: 0x000000000000, Name: READ_EOUT

The READ_EOUT command reads the reverse flow energy meter registers in a single operation to ensure time consistent data. READ_EOUT accumulates power data when IOUT is negative.

Table 24. Bit Descriptions for READ_EOUT

Bits	Bit Name	Settings	Description	Reset	Access
[47:24]	SAMPLE_COUNT		Duplicate of corresponding bit in READ_EIN.	0x000000	R
[23:16]	EOUT_ROLLOVER_COUNT		Number of times that the reverse flow energy count has rolled over. On the ADM1293-1 and the ADM1294-1 , the rollover counter increases by 1 each time the energy count rolls over from 0xFFFF to 0x0000. On the ADM1293-2 and the ADM1294-2 , the rollover counter increases by 1 each time the energy count rolls over from 0x7FFF to 0x0000. This is an unsigned 8-bit binary value.	0x00	R
[15:0]	EOUT_ENERGY_COUNT		Reverse flow energy accumulator value in direct format. Byte 1 is the high byte, and Byte 0 is the low byte. On the ADM1293-1 and ADM1294-1 , the data is presented as unsigned integer. On the ADM1293-2 and ADM1294-2 , the data is presented in twos complement format. Internally, the energy accumulator is a 24-bit value, but only the most significant 16 bits are returned with this command. Use the READ_EOUT_EXT to access the nontruncated version.	0x0000	R

READ VIN REGISTER

Address: 0x88, Reset: 0x0000, Name: READ_VIN

The READ_VIN command reads the input voltage, VIN, from the device.

Table 25. Bit Descriptions for READ_VIN

Bits	Bit Name	Settings	Description	Reset	Access
[15:12]	RESERVED		Always reads as 0000b.	0x0	Reserved
[11:0]	READ_VIN		Voltage measurement on the VIN pin after averaging, expressed in direct format.	0x000	R

READ IOUT REGISTER

Address: 0x8C, Reset: 0x0000, Name: READ_IOUT

The READ_IOUT command reads the output current, IOUT, from the device.

Table 26. Bit Descriptions for READ_IOUT

Bits	Bit Name	Settings	Description	Reset	Access
[15:0]	READ_IOUT		Current measurement derived from differential voltage between the SENSEP and SENSEN pins, after averaging, expressed in direct format.	0x0000	R

READ PIN REGISTER

Address: 0x97, Reset: 0x0000, Name: READ_PIN

The READ_PIN command reads the calculated input power, PIN, from the device.

Table 27. Bit Descriptions for READ_PIN

Bits	Bit Name	Settings	Description	Reset	Access
[15:0]	READ_PIN		Input power calculation, using $VIN \times IOUT$, after averaging, expressed in direct format.	0x0000	R

PMBus REVISION REGISTER

Address: 0x98, Reset: 0x22, Name: PMBUS_REVISION

The PMBUS_REVISION command allows the system to read the PMBus revision that the device supports.

Table 28. Bit Descriptions for PMBUS_REVISION

Bits	Bit Name	Settings	Description	Reset	Access
[7:4]	PMBUS_P1_REVISION	0010	PMBus Part I Support. Revision 1.2.	0x2	R
[3:0]	PMBUS_P2_REVISION	0010	PMBus Part II Support. Revision 1.2.	0x2	R

MANUFACTURER ID REGISTER

Address: 0x99, Reset: 0x494441, Name: MFR_ID

The MFR_ID command returns a string identifying the manufacturer of the device.

Table 29. Bit Descriptions for MFR_ID

Bits	Bit Name	Settings	Description	Reset	Access
[23:0]	MFR_ID		String identifying manufacturer as ADI.	0x494441	R

MANUFACTURER MODEL REGISTER

Address: 0x9A, Name: MFR_MODEL

The MFR_MODEL command returns a string identifying the specific model of the device.

Table 30. Bit Descriptions for MFR_MODEL

Bits	Bit Name	Settings	Description	Reset	Access
[79:0]	MFR_MODEL		String identifying model as ADM129x-yz, where x identifies the particular model, y identifies the particular model type, and z identifies the grade.		R

MANUFACTURER REVISION REGISTER

Address: 0x9B, Reset: 0x32, Name: MFR_REVISION

The MFR_REVISION command returns a string identifying the hardware revision of the device.

Table 31. Bit Descriptions for MFR_REVISION

Bits	Bit Name	Settings	Description	Reset	Access
[7:0]	MFR_REVISION		String identifying hardware revision in ASCII code, for example 0x32 for 2.	0x32	R

MAXIMUM IOOUT REGISTER

Address: 0xD0, Reset: 0xF800, Name: MAX_IOOUT

The MAX_IOOUT command reports the most positive IOOUT value recorded, expressed in direct format. Writing a 0 with this command resets it to the default value.

Table 32. Bit Descriptions for MAX_IOOUT

Bits	Bit Name	Settings	Description	Reset	Access
[15:0]	MAX_IOOUT		Reports the most positive IOOUT value recorded, expressed in direct format. Writing 0 with this command resets it to the default value.	0xF800	R

PEAK VIN REGISTER

Address: 0xD1, Reset: 0x0000, Name: PEAK_VIN

The PEAK_VIN command reports the most positive VIN value recorded, expressed in direct format. Writing a 0 with this command resets it to the default value.

Table 33. Bit Descriptions for PEAK_VIN

Bits	Bit Name	Settings	Description	Reset	Access
[15:12]	RESERVED		Always reads as 0000b.	0x0	Reserved
[11:0]	PEAK_VIN		Reports the most positive VIN value recorded, expressed in direct format. Writing 0 with this command resets it to the default value.	0x000	R

PEAK VAUX REGISTER

Address: 0xD2, Reset: 0x0000, Name: PEAK_VAUX

The PEAK_VAUX command reports the most positive VAUX value recorded, expressed in direct format. Writing a 0 with this command resets it to the default value.

Table 34. Bit Descriptions for PEAK_VAUX

Bits	Bit Name	Settings	Description	Reset	Access
[15:12]	RESERVED		Always reads as 0000b.	0x0	Reserved
[11:0]	PEAK_VAUX		Reports the most positive VAUX value recorded, expressed in direct format. Writing 0 with this command resets it to the default value.	0x000	R

POWER MONITOR CONTROL REGISTER

Address: 0xD3, Reset: 0x01, Name: PMON_CONTROL

The PMON_CONTROL command starts and stops the power monitor.

Table 35. Bit Descriptions for PMON_CONTROL

Bits	Bit Name	Settings	Description	Reset	Access
[7:1]	RESERVED		Always reads as 0000000b.	0x00	Reserved
0	CONVERT	0 1	Convert enable. 0 Power monitor is not running. 1 Power monitor is sampling. In single shot mode, this bit clears itself after one complete cycle. In continuous mode, this bit must be written to 0 to stop sampling. A rising edge on a convert (CONV) input pin sets this bit to 1. During sampling, additional rising edges on CONV are ignored.	0x1	RWAS

POWER MONITOR CONFIGURATION REGISTER

Address: 0xD4, Reset: 0x0714, Name: PMON_CONFIG

The PMON_CONFIG command is used to configure the power monitor. Different combinations of channels can be included in the sampling round robin, and averaging can be set for different measurements.

Table 36. Bit Descriptions for PMON_CONFIG

Bits	Bit Name	Settings	Description	Reset	Access
15	RESERVED		Always reads as 0.	0x0	Reserved
14	SIMULTANEOUS	0 1	Simultaneous sampling mode enable. Simultaneous sampling disabled. Simultaneous sampling enabled.	0x0	RW
[13:11]	PWR_AVG	000 001 010 011 100 101 110 111	PIN averaging mode select. Disables sample averaging for power. Sets sample averaging for power to two samples. Sets sample averaging for power to four samples. Sets sample averaging for power to eight samples. Sets sample averaging for power to 16 samples. Sets sample averaging for power to 32 samples. Sets sample averaging for power to 64 samples. Sets sample averaging for power to 128 samples.	0x0	RW
[10:8]	VI_AVG	000 001 010 011 100 101 110 111	VIN/VAUX/IOOUT averaging mode select. Disables sample averaging for current and voltage. Sets sample averaging for current and voltage to two samples. Sets sample averaging for current and voltage to four samples. Sets sample averaging for current and voltage to eight samples. Sets sample averaging for current and voltage to 16 samples. Sets sample averaging for current and voltage to 32 samples. Sets sample averaging for current and voltage to 64 samples. Sets sample averaging for current and voltage to 128 samples.	0x7	RW
[7:6]	IRANGE	00 01 10 11	Current sense range (CSR) select. Sets current sense range to ± 25 mV. Sets current sense range to ± 50 mV. Sets current sense range to ± 100 mV. Sets current sense range to ± 200 mV.	0x0	RW
5	RESERVED		Always reads as 0.	0x0	Reserved
4	PMON_MODE	0 1	Conversion mode select. Single shot sampling. Continuous sampling.	0x1	RW
[3:2]	VIN_SEL	00 01 10 11	VIN Sampling mode select. VIN sampling disabled. VIN sampling as direct ADC input with full scale of 1.2 V. VIN sampling with ADC full scale of 7.4 V. VIN sampling with ADC full scale of 21 V.	0x1	RW
1	VAUX_EN	0 1	VAUX sampling enable. VAUX sampling disabled. VAUX sampling enabled.	0x0	RW
0	RESERVED		Always reads as 0.	0x0	Reserved

ALERT 1 CONFIGURATION REGISTER

Address: 0xD5, Reset: 0x0000, Name: ALERT1_CONFIG

The ALERT1_CONFIG command allows different combinations of faults and warnings to be configured on the GPO1/ALERT1/CONV output pin. The pin can operate in different modes, configured using the DEVICE_CONFIG command.

Table 37. Bit Descriptions for ALERT1_CONFIG

Bits	Bit Name	Settings	Description	Reset	Access
[15:12]	RESERVED		Always reads as 0000b.	0x0	Reserved
11	CML_ERROR_EN1		Communications error enable.	0x0	RW
10	IOUT_OC_WARN_EN1		IOUT overcurrent warning enable.	0x0	RW
9	HYSTERETIC_EN1		Hysteretic output enable.	0x0	RW
8	VIN_OV_WARN_EN1		VIN overvoltage warning enable.	0x0	RW
7	VIN_UV_WARN_EN1		VIN undervoltage warning enable.	0x0	RW
6	VAUX_OV_WARN_EN1		VAUX overvoltage warning enable.	0x0	RW
5	VAUX_UV_WARN_EN1		VAUX undervoltage warning enable.	0x0	RW
4	RESERVED		Always reads as 0.	0x0	Reserved
3	PIN_OP_WARN_EN1		PIN overpower warning enable.	0x0	RW
[2:0]	RESERVED		Always reads as 000b.	0x0	Reserved

ALERT 2 CONFIGURATION REGISTER

Address: 0xD6, Reset: 0x0000, Name: ALERT2_CONFIG

The ALERT2_CONFIG command allows different combinations of faults and warnings to be configured on the GPO2/ALERT2 output pin. The pin can operate in different modes, configured using the DEVICE_CONFIG command.

Table 38. Bit Descriptions for ALERT2_CONFIG

Bits	Bit Name	Settings	Description	Reset	Access
[15:12]	RESERVED		Always reads as 0000b.	0x0	Reserved
11	CML_ERROR_EN2		Communications error enable.	0x0	RW
10	IOUT_OC_WARN_EN2		IOUT overcurrent warning enable.	0x0	RW
9	HYSTERETIC_EN2		Hysteretic output enable.	0x0	RW
8	VIN_OV_WARN_EN2		VIN overvoltage warning enable.	0x0	RW
7	VIN_UV_WARN_EN2		VIN undervoltage warning enable.	0x0	RW
6	VAUX_OV_WARN_EN2		VAUX overvoltage warning enable.	0x0	RW
5	VAUX_UV_WARN_EN2		VAUX undervoltage warning enable.	0x0	RW
4	RESERVED		Always reads as 0.	0x0	Reserved
3	PIN_OP_WARN_EN2		PIN overpower warning enable.	0x0	RW
[2:0]	RESERVED		Always reads as 000b.	0x0	Reserved

DEVICE CONFIGURATION REGISTER

Address: 0xD8, Reset: 0x0000, Name: DEVICE_CONFIG

The DEVICE_CONFIG command configures the GPO1/GPO2 output modes.

Table 39. Bit Descriptions for DEVICE_CONFIG

Bits	Bit Name	Settings	Description	Reset	Access
[15:11]	RESERVED		Always reads as 0000b.	0x0	Reserved
10	PWR_HYST_EN	0 1	Power hysteretic comparison enable. When enabled the hysteresis functions refer to power rather than current. The HYSTERETIC_EN bit also needs to be set in ALERT_CONFIG. 0 Current hysteresis mode. 1 Power hysteresis mode.	0x0	RW
[9:8]	GPO2_MODE	00 01 10 11	GPO2 configuration mode. 00 Default. GPO2 is configured to generate SMBALERTs. 01 GPO2 can be used a general-purpose digital output pin. The GPO2_INVERT bit is used to change the output state. 10 Reserved. 11 Digital comparator mode. The output pin now reflects the live status of the warning or fault bit selected for the output. In effect, this is a nonlatched SMBALERT.	0x0	RW
7	GPO2_INVERT	0 1	GPO invert mode. 0 In SMBALERT mode the output is not inverted, and active low. In GPO mode, the output is set low. 1 In SMBALERT mode the output is inverted, and active high. In GPO mode, the output is set high.	0x0	RW
[6:5]	GPO1_MODE	00 01 10 11	GPO1 configuration mode. 00 Default. GPO1 is configured to generate SMBALERTs. 01 GPO1 can be used a general-purpose digital output pin. The GPO1_INVERT bit is used to change the output state. 10 GPO1 is configured as a convert (CONV) input pin. 11 Digital comparator mode. The output pin reflects the live status of the warning or fault bit selected for the output. In effect, this is a nonlatched SMBALERT.	0x0	RW
4	GPO1_INVERT	0 1	GPO1 invert mode. 0 In SMBALERT mode, the output is not inverted, and active low. In GPO mode, the output is set low. 1 In SMBALERT mode the output is inverted, and active high. In GPO mode, the output is set high.	0x0	RW
[3:0]	RESERVED		Always reads as 0000b.	0x0	Reserved

MAXIMUM PIN REGISTER

Address: 0xDA, Reset: 0x8000, Name: MAX_PIN

The MAX_PIN command reports the most positive PIN value recorded, expressed in direct format. Writing 0 with this command resets it to the default value.

Table 40. Bit Descriptions for MAX_PIN

Bits	Bit Name	Settings	Description	Reset	Access
[15:0]	MAX_PIN		Reports the most positive PIN value recorded, expressed in direct format. Writing 0 with this command resets it to the default value.	0x8000	R

READ PIN (EXTENDED) REGISTER

Address: 0xDB, Reset: 0x000000, Name: READ_PIN_EXT

The READ_PIN_EXT command reads the extended precision version of the calculated input power, PIN, from the device.

Table 41. Bit Descriptions for READ_PIN_EXT

Bits	Bit Name	Settings	Description	Reset	Access
[23:0]	READ_PIN_EXT		Extended precision version of input power calculation, PIN, expressed in direct format.	0x000000	R

READ EIN (EXTENDED) REGISTER

Address: 0xDC, Reset: 0x0000000000000000, Name: READ_EIN_EXT

The READ_EIN_EXT command reads the extended precision version of the forward flow energy meter register, EIN, from the device.

Table 42. Bit Descriptions for READ_EIN_EXT

Bits	Bit Name	Settings	Description	Reset	Access
[63:40]	SAMPLE_COUNT		These bits report the total number of PIN samples acquired and accumulated in both the forward and reverse flow energy count accumulator. Byte 7 is the high byte, Byte 6 is the middle byte, and Byte 5 is the low byte.	0x000000	R
[39:24]	EIN_ROLLOVER_EXT		These bits report the number of times that the forward flow energy count has rolled over. On the ADM1293-1 and ADM1294-1 , the rollover counter increases by 1 each time the energy count rolls over from 0xFFFFF to 0x000000. On the ADM1293-2 and ADM1294-2 , the rollover counter increases by 1 each time the energy count rolls over from 0x7FFFFF to 0x000000. This is an unsigned 16-bit binary value. Byte 4 is the high byte, and Byte 3 is the low byte.	0x0000	R
[23:0]	EIN_ENERGY_EXT		Extended precision forward flow energy accumulator value in direct format. Byte 2 is the high byte, and Byte 0 is the low byte. On the ADM1293-1 and ADM1294-1 , the data is presented as unsigned integer. On the ADM1293-2 and ADM1294-2 , the data is presented in twos complement format.	0x000000	R

READ VAUX REGISTER

Address: 0xDD, Reset: 0x0000, Name: READ_VAUX

The READ_VAUX command reads the auxiliary input voltage, V_{VAUX} , from the device.

Table 43. Bit Descriptions for READ_VAUX

Bits	Bit Name	Settings	Description	Reset	Access
[15:12]	RESERVED		Always reads as 0000b.	0x0	Reserved
[11:0]	READ_VAUX		Voltage measurement on VAUX pin after averaging, expressed in direct format.	0x000	R

VAUX OV WARNING LIMIT REGISTER

Address: 0xDE, Reset: 0x0FFE, Name: VAUX_OV_WARN_LIMIT

The VAUX_OV_WARN_LIMIT command sets the overvoltage warning limit for the voltage measured on the VAUX pin.

Table 44. Bit Descriptions for VAUX_OV_WARN_LIMIT

Bits	Bit Name	Settings	Description	Reset	Access
[15:12]	RESERVED		Always reads as 0000b.	0x0	Reserved
[11:0]	VAUX_OV_WARN_LIMIT		Overvoltage warning threshold for the VAUX pin measurement, expressed in direct format. Set these bits to the default value to disable.	0xFF	RW

VAUX UV WARNING LIMIT REGISTER

Address: 0xDF, Reset: 0x0000, Name: VAUX_UV_WARN_LIMIT

The VAUX_UV_WARN_LIMIT command sets the undervoltage warning limit for the voltage measured on the VAUX pin.

Table 45. Bit Descriptions for VAUX_UV_WARN_LIMIT

Bits	Bit Name	Settings	Description	Reset	Access
[15:12]	RESERVED		Always reads as 0000b.	0x0	Reserved
[11:0]	VAUX_UV_WARN_LIMIT		Undervoltage warning threshold for the VAUX pin measurement, expressed in direct format. Set these bits to the default value to disable.	0x000	RW

MINIMUM IOUT REGISTER

Address: 0xE3, Reset: 0x7FF, Name: MIN_IOUT

The MIN_IOUT command reports the most negative IOUT value recorded, expressed in direct format. Writing 0 with this command resets it to the default value.

Table 46. Bit Descriptions for MIN_IOUT

Bits	Bit Name	Settings	Description	Reset	Access
[15:0]	MIN_IOUT		Reports the most negative IOUT value recorded, expressed in direct format. Writing 0 with this command resets it to the default value.	0x7FF	R

MINIMUM PIN REGISTER

Address: 0xE4, Reset: 0x7FFF, Name: MIN_PIN

The MIN_PIN command reports the most negative PIN value recorded, expressed in direct format. Writing 0 with this command resets it to the default value.

Table 47. Bit Descriptions for MIN_PIN

Bits	Bit Name	Settings	Description	Reset	Access
[15:0]	MIN_PIN		Reports the most negative PIN value recorded, expressed in direct format. Writing 0 with this command resets it to the default value.	0x7FFF	R

READ EOUT (EXTENDED) REGISTER

Address: 0xE5, Reset: 0x0000000000000000, Name: READ_EOUT_EXT

The READ_EOUT_EXT command reads the extended precision version of the reverse flow energy meter register, EOUT, from the device.

Table 48. Bit Descriptions for READ_EOUT_EXT

Bits	Bit Name	Settings	Description	Reset	Access
[63:40]	SAMPLE_COUNT		Duplicate of corresponding bit in READ_EIN_EXT.	0x000000	R
[39:24]	EOUT_ROLLOVER_EXT		Reports the number of times that the reverse flow energy count has rolled over. On the ADM1293-1 and ADM1294-1 , the rollover counter increases by 1 each time the energy count rolls over from 0xFFFFF to 0x000000. On the ADM1293-2 and ADM1294-2 , the rollover counter increases by 1 each time the energy count rolls over from 0x7FFFF to 0x000000. This is an unsigned 16-bit binary value. Byte 4 is the high byte, and Byte 3 is the low byte.	0x0000	R
[23:0]	EOUT_ENERGY_EXT		Extended precision reverse flow energy accumulator value in direct format. Byte 2 is the high byte, and Byte 0 is the low byte. On the ADM1293-1 and ADM1294-1 , the data is presented as unsigned integer. On the ADM1293-2 and ADM1294-2 , the data is presented in twos complement format.	0x000000	R

HYSTERESIS LOW THRESHOLD LEVEL REGISTER

Address: 0xF2, Reset: 0x8000, Name: HYSTERESIS_LOW

The HYSTERESIS_LOW command sets the lower threshold used to generate the hysteretic output signal that is available on a GPOx pin.

Table 49. Bit Descriptions for HYSTERESIS_LOW

Bits	Bit Name	Settings	Description	Reset	Access
[15:0]	HYSTERESIS_LOW		Value setting the lower hysteresis threshold, expressed in direct format.	0x8000	RW

HYSTERESIS HIGH THRESHOLD LEVEL REGISTER

Address: 0xF3, Reset: 0x7FFF, Name: HYSTERESIS_HIGH

The HYSTERESIS_HIGH command sets the higher threshold that generates the hysteretic output signal that is available on a GPOx pin.

Table 50. Bit Descriptions for HYSTERESIS_HIGH

Bits	Bit Name	Settings	Description	Reset	Access
[15:0]	HYSTERESIS_HIGH		Value setting the higher hysteresis threshold, expressed in direct format.	0x7FFF	RW

HYSTERESIS STATUS REGISTER

Address: 0xF4, Reset: 0x00, Name: STATUS_HYSTERESIS

The STATUS_HYSTERESIS status register reports if the hysteretic comparison is above or below the user defined HYSTERESIS_HIGH and HYSTERESIS_LOW thresholds, the resulting hysteretic output and the IOUT_OC_WARNING status bit.

Table 51. Bit Descriptions for STATUS_HYSTERESIS

Bits	Bit Name	Settings	Description	Reset	Access
[7:4]	RESERVED		Always reads as 0000b.	0x0	Reserved
3	IOUT_OC_WARN	0 1	IOUT overcurrent warning. 0 No overcurrent condition on the output supply detected by the power monitor using the IOUT_OC_WARN_LIMIT command. 1 An overcurrent condition was detected by the power monitor using the IOUT_OC_WARN_LIMIT command.	0x0	R
2	HYST_STATE	0 1	Hysteretic comparison output. 0 Comparison output low. 1 Comparison output high.	0x0	R
1	HYST_GT_HIGH	0 1	Hysteretic upper threshold comparison. 0 Compared value is equal or below upper threshold. 1 Compared value is above upper threshold.	0x0	R
0	HYST_LT_LOW	0 1	Hysteretic lower threshold comparison. 0 Compared value is equal or above the lower threshold. 1 Compared value is below the lower threshold.	0x0	R

OUTLINE DIMENSIONS



COMPLIANT TO JEDEC STANDARDS MO-220-WGGC.

Figure 41. 16-Lead Lead Frame Chip Scale Package [LFCSP_WQ]
4 mm x 4 mm Body, Very Very Thin Quad
(CP-16-17)

Dimensions shown in millimeters

08-16-2010-C



COMPLIANT TO JEDEC STANDARDS MO-153-AB-1

Figure 42. 14-Lead Thin Shrink Small Outline Package [TSSOP]
RU-14

Dimensions shown in millimeters

061908-A

ORDERING GUIDE

Model ¹	Temperature Range ²	Grade	Package Description	Package Option
ADM1293-1AACPZ	-40°C to +105°C	A	16-Lead LFCSP_WQ	CP-16-17
ADM1293-1AACPZ-RL7	-40°C to +105°C	A	16-Lead LFCSP_WQ	CP-16-17
ADM1293-1BACPZ	-40°C to +105°C	B	16-Lead LFCSP_WQ	CP-16-17
ADM1293-1BACPZ-RL7	-40°C to +105°C	B	16-Lead LFCSP_WQ	CP-16-17
ADM1293-1AARUZ	-40°C to +105°C	A	14-Lead TSSOP	RU-14
ADM1293-1AARUZ-RL7	-40°C to +105°C	A	14-Lead TSSOP	RU-14
ADM1293-1BARUZ	-40°C to +105°C	B	14-Lead TSSOP	RU-14
ADM1293-1BARUZ-RL7	-40°C to +105°C	B	14-Lead TSSOP	RU-14
ADM1293-2AACPZ	-40°C to +105°C	A	16-Lead LFCSP_WQ	CP-16-17
ADM1293-2AACPZ-RL	-40°C to +105°C	A	16-Lead LFCSP_WQ	CP-16-17
ADM1294-1AACPZ	-40°C to +105°C	A	16-Lead LFCSP_WQ	CP-16-17
ADM1294-1AACPZ-RL7	-40°C to +105°C	A	16-Lead LFCSP_WQ	CP-16-17
ADM1294-1BACPZ	-40°C to +105°C	B	16-Lead LFCSP_WQ	CP-16-17
ADM1294-1BACPZ-RL7	-40°C to +105°C	B	16-Lead LFCSP_WQ	CP-16-17
ADM1294-1AARUZ	-40°C to +105°C	A	14-Lead TSSOP	RU-14
ADM1294-1AARUZ-RL7	-40°C to +105°C	A	14-Lead TSSOP	RU-14
ADM1294-1BARUZ	-40°C to +105°C	B	14-Lead TSSOP	RU-14
ADM1294-1BARUZ-RL7	-40°C to +105°C	B	14-Lead TSSOP	RU-14
ADM1294-2AACPZ	-40°C to +105°C	A	16-Lead LFCSP_WQ	CP-16-17
ADM1294-2AACPZ-RL	-40°C to +105°C	A	16-Lead LFCSP_WQ	CP-16-17
EVAL-ADM1293EBZ			Evaluation Kit	
EVAL-ADM1294EBZ			Evaluation Kit	

¹ Z = RoHS Compliant Part.² The operation temperature is specified as ambient for [ADM1293](#) and junction for [ADM1294](#).