

FEATURES

- 5.7 kV rms signal isolated CAN FD transceiver
- 1500 V peak and dc working voltage to DIN VDE 0884-11
- 1.7 V to 5.5 V supply and logic side levels
- 4.5 V to 5.5 V supply on bus side
- ISO 11898-2:2016-compliant CAN FD
- Data rates up to 12 Mbps for CAN FD
- Low maximum loop propagation delay: 155 ns
- Extended common-mode range: ± 25 V
- Bus fault protection (CANH, CANL): ± 40 V
- ESD protection on the CANH and CANL bus pins
 - $\geq \pm 8$ kV IEC 61000-4-2 contact discharge
 - $\geq \pm 15$ kV IEC 61000-4-2 air discharge
- Passes EN 55022, Class B by 6 dB
- Safety and regulatory approvals (pending)
 - UL: 5700 V rms for 1-minute per UL 1577
 - CSA Component Acceptance 5A at 5.7 kV rms IEC 60601 and IEC 61010
 - VDE Certificates of Conformity
 - DIN VDE V 0884-11 (VDE V 0884-11):2017-01
 - $V_{IORM} = 1500$ V peak
- High common-mode transient immunity: > 50 kV/ μs
- Industrial operating temperature range: -40°C to $+125^\circ\text{C}$

APPLICATIONS

- CANOpen, DeviceNet, and other CAN bus implementations
- Industrial automation
- Process control and building control
- Transport and infrastructure

GENERAL DESCRIPTION

The ADM3058E is a 5.7 kV rms isolated controller area network (CAN) physical layer transceiver with a high performance, basic feature set. The ADM3058E fully meets the CAN flexible data rate (CAN FD) ISO 11898-2:2016 requirements and is further capable of supporting data rates as high as 12 Mbps.

The device employs Analog Devices, Inc., *iCoupler*[®] technology to combine a 2-channel isolator and a CAN transceiver into a single small outline integrated circuit (SOIC) surface-mount package. The ADM3058E is a fully isolated solution for CAN and CAN FD applications. The ADM3058E provides isolation between the CAN controller and physical layer bus. Safety and

FUNCTIONAL BLOCK DIAGRAM

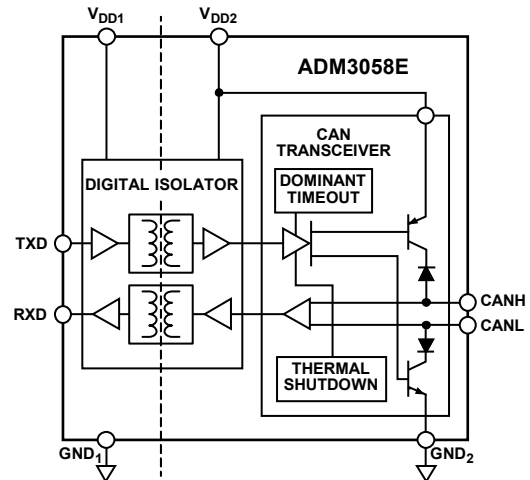

Figure 1.

20135-001

regulatory approvals (pending) for a 5.7 kV rms withstand voltage and a 1500 V peak working voltage ensure that the ADM3058E meets application isolation requirements.

Low loop propagation delays and the extended common-mode range of ± 25 V support robust communication on longer bus cables. Dominant timeout functionality protects against bus lock up in a fault condition, and current limiting and thermal shutdown features protect against output short circuits. The CAN bus input and output pins are protected to ± 40 V against accidental connection to a +24 V bus supply. The device is fully specified over the -40°C to $+125^\circ\text{C}$ industrial temperature range.

TABLE OF CONTENTS

Features	1	Theory of Operation	14
Applications	1	CAN Transceiver Operation	14
Functional Block Diagram	1	Signal Isolation	14
General Description	1	Integrated and Certified IEC Electromagnetic Compatibility (EMC) Solution	14
Revision History	2	±40 V Miswire Protection.....	14
Specifications	3	Dominant Timeout.....	14
Timing Specifications	5	Fail-Safe Features	14
Insulation and Safety Related Specifications.....	6	Thermal Shutdown	15
Package Characteristics	6	Applications Information	16
Regulatory Information.....	6	Radiated Emissions and PCB Layout	16
DIN V VDE V 0884-11 (VDE V 0884-11) Insulation Characteristics (Pending).....	7	PCB Layout	16
Absolute Maximum Ratings	8	Thermal Analysis	16
Thermal Resistance	8	Insulation Lifetime.....	16
Electrostatic Discharge (ESD) Ratings	8	Surface Tracking.....	16
ESD Caution.....	8	Insulation Wear Out.....	16
Pin Configuration and Function Descriptions	9	Calculation and Use of Parameters Example.....	17
Typical Performance Characteristics.....	10	Outline Dimensions.....	18
Test Circuits	12	Ordering Guide	18
Terminology.....	13		

REVISION HISTORY

8/2020—Rev. 0 to Rev. A

Changes to Data Sheet Title and Features Section	1
--	---

6/2020—Revision 0: Initial Version

SPECIFICATIONS

All voltages are relative to their respective ground, $1.7\text{ V} \leq V_{DD1} \leq 5.5\text{ V}$, $4.5\text{ V} \leq V_{DD2} \leq 5.5\text{ V}$, and $-40^\circ\text{C} \leq T_A \leq +125^\circ\text{C}$, unless otherwise noted. Typical specifications are at $V_{DD1} = V_{DD2} = 5\text{ V}$ and $T_A = 25^\circ\text{C}$, unless otherwise noted.

Table 1.

Parameter	Symbol	Min	Typ	Max	Unit	Test Conditions/Comments
SUPPLY CURRENT						
Bus Side	I_{DD2}					
Recessive State			5.3	7	mA	TXD high, load resistance (R_L) = 60 Ω
Dominant State			63	75	mA	Limited by transmit dominant timeout (t_{DT}), see the Theory of Operation section, $R_L = 60\ \Omega$
70% Dominant/30% Recessive						Worst case, see the Theory of Operation section, $R_L = 60\ \Omega$
1 Mbps			45	58	mA	
5 Mbps			49	60	mA	
12 Mbps		58	65	mA		
Logic Side <i>i</i> Coupler Current	I_{DD1}			5.5	mA	TXD high, low, or switching
DRIVER						
Differential Outputs						See Figure 17
Recessive State Voltage						TXD high, R_L , and common-mode filter capacitor (C_F) open
CANH, CANL	V_{CANL} V_{CANH}	2.0		3.0	V	
Differential Output	V_{OD}	-500		+50	mV	
Dominant State Voltage						TXD low, C_F open
CANH	V_{CANH}	2.75		4.5	V	$50\ \Omega \leq R_L \leq 65\ \Omega$
CANL	V_{CANL}	0.5		2.0	V	$50\ \Omega \leq R_L \leq 65\ \Omega$
Differential Output	V_{OD}	1.5		3.0	V	$50\ \Omega \leq R_L \leq 65\ \Omega$
		1.4		3.3	V	$45\ \Omega \leq R_L \leq 70\ \Omega$
		1.5		5.0	V	$R_L = 2240\ \Omega$
Output Symmetry ($V_{DD2} - V_{CANH}$ to V_{CANL})	V_{SYM}	-0.55		+0.55	V	$R_L = 60\ \Omega$, $C_F = 4.7\ \text{nF}$
Short-Circuit Current	$ I_{sc} $					R_L open
Absolute						
CANH				115	mA	$V_{CANH} = -3\text{ V}$
CANL				115	mA	$V_{CANL} = 18\text{ V}$
Steady State						
CANH				115	mA	$V_{CANH} = -24\text{ V}$
CANL				115	mA	$V_{CANL} = 24\text{ V}$
Logic Input TXD						
Input Voltage						
High	V_{IH}	$0.65 \times V_{DD1}$			V	
Low	V_{IL}			$0.35 \times V_{DD1}$	V	
Complementary Metal-Oxide Semiconductor (CMOS) Logic Input Currents	$ I_{IH} , I_{IL} $			10	μA	Input high or low
RECEIVER						
Differential Inputs						
Differential Input Voltage Range	V_{ID}					See Figure 18, RXD capacitance (C_{RXD}) open, $-25\text{ V} < V_{CANL}, V_{CANH} < +25\text{ V}$
Recessive		-1.0		+0.5	V	
Dominant		0.9		5.0	V	

Parameter	Symbol	Min	Typ	Max	Unit	Test Conditions/Comments
Input Voltage Hysteresis	V_{HYS}		150		mV	
Unpowered Input Leakage Current	$ I_{IN(OFF)} $			10	μA	$V_{CANH}, V_{CANL} = 5 V, V_{DD2} = 0 V$
Input Resistance						
CANH, CANL	R_{INH}, R_{INL}	6		25	k Ω	See Figure 21
Differential	R_{DIFF}	20		100	k Ω	See Figure 20
Input Resistance Matching	m_R	-0.03		+0.03		$m_R = 2 \times (R_{INH} - R_{INL}) / (R_{INH} + R_{INL})$
Input Capacitance						
CANH, CANL	C_{INH}, C_{INL}		35		pF	See Figure 21
Differential	C_{DIFF}		12		pF	See Figure 20
Logic Output (RXD)						
Output Voltage						
Low	V_{OL}		0.2	0.4	V	Output impedance (I_{OUT}) = 2 mA
High	V_{OH}	$V_{DD1} - 0.2$			V	$I_{OUT} = -2$ mA
Short-Circuit Current	I_{OS}	7		85	mA	Output voltage (V_{OUT}) = GND ₁ or V_{DD1}
COMMON-MODE TRANSIENT IMMUNITY ¹						Common-mode voltage (V_{CM}) ≥ 1 kV, transient magnitude ≥ 800 V
Input High, Recessive	$ CM_H $	50	100		kV/ μs	Input voltage (V_{IN}) = V_{DD1} (TXD) or CANH/CANL recessive
Input Low, Dominant	$ CM_L $	50	100		kV/ μs	$V_{IN} = 0$ V (TXD) or CANH/CANL dominant

¹ $|CM_H|$ is the maximum common-mode voltage slew rate that can be sustained while maintaining CANH/CANL recessive or $RXD \geq V_{DD1} - 0.2$ V. $|CM_L|$ is the maximum common-mode voltage slew rate that can be sustained while maintaining CANH/CANL dominant or $RXD \leq 0.4$ V. The common-mode voltage slew rates apply to both rising and falling common-mode voltage edges.

TIMING SPECIFICATIONS

All voltages are relative to their respective ground, $1.7\text{ V} \leq V_{DD1} \leq 5.5\text{ V}$, $4.5\text{ V} \leq V_{DD2} \leq 5.5\text{ V}$, and $-40^\circ\text{C} \leq T_A \leq +125^\circ\text{C}$, unless otherwise noted. Typical specifications are at $V_{DD1} = V_{DD2} = 5\text{ V}$ and $T_A = 25^\circ\text{C}$, unless otherwise noted.

Table 2.

Parameter	Symbol	Min	Typ	Max	Unit	Test Conditions/Comments
DRIVER						
Maximum Data Rate		12			Mbps	See Figure 2 and Figure 17, $t_{\text{BIT_TXD}}^1 = 200\text{ ns}$, $R_L = 60\ \Omega$, load capacitance (C_L) = 100 pF
Propagation Delay from TXD to Bus						
Recessive to Dominant	$t_{\text{TXD_DOM}}$		35	60	ns	
Dominant to Recessive	$t_{\text{TXD_REC}}$		45	70	ns	
Transmit Dominant Timeout	t_{DT}	1175		4000	μs	TXD low, see Figure 3
RECEIVER						
Loop Propagation Delay						
Falling Edge (TXD to RXD)	$t_{\text{LOOP_FALL}}$			155	ns	
Rising Edge (TXD to RXD)	$t_{\text{LOOP_RISE}}$			155	ns	
Loop Delay Symmetry (Minimum Recessive Bit Width)	$t_{\text{BIT_RXD}}$					
2 Mbps		450		550	ns	$t_{\text{BIT_TXD}} = 500\text{ ns}$
5 Mbps		160		220	ns	$t_{\text{BIT_TXD}} = 200\text{ ns}$
8 Mbps		85		140	ns	$t_{\text{BIT_TXD}} = 125\text{ ns}$
12 Mbps		50		91.6	ns	$t_{\text{BIT_TXD}} = 83.3\text{ ns}$

¹ $t_{\text{BIT_TXD}}$ is the bit time at the TXD pin as transmitted by the CAN controller.

Timing Diagrams

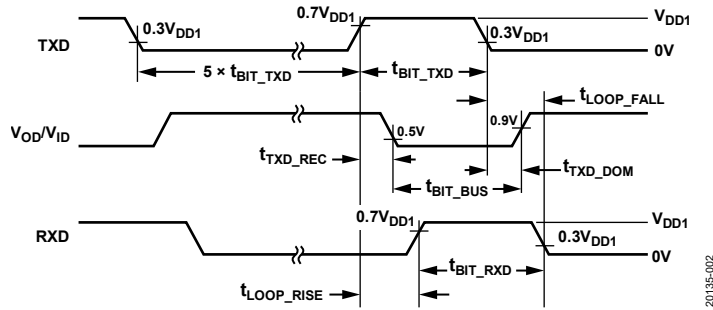

Figure 2. Transceiver Timing Diagram

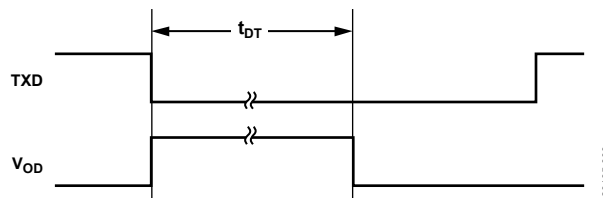

Figure 3. Dominant Timeout, t_{DT}

INSULATION AND SAFETY RELATED SPECIFICATIONS

For additional information, see www.analog.com/icouplersafety.

Table 3.

Parameter	Symbol	Value	Unit	Test Conditions/Comments
Rated Dielectric Insulation Voltage		5700	V rms	1-minute duration
Minimum External Air Gap (Clearance)	L (I01)	8.3	mm min	Measured from input terminals to output terminals, shortest distance through air
Minimum External Tracking (Creepage)	L (I02)	8.3	mm min	Measured from input terminals to output terminals, shortest distance path along body
Minimum Clearance in the Plane of the Printed Circuit Board (PCB) Clearance	L (PCB)	8.3	mm min	Measured from input terminals to output terminals, shortest distance through air, line of sight, in the PCB mounting plane
Minimum Internal Gap (Internal Clearance)		40	µm min	Insulation distance through insulation
Tracking Resistance (Comparative Tracking Index)	CTI	>600	V	DIN IEC 112/VDE 0303 Part 1
Material Group		I		Material group (DIN VDE 0110, 1/89, Table 1)

PACKAGE CHARACTERISTICS

Table 4.

Parameter	Symbol	Min	Typ	Max	Unit	Test Conditions/Comments
Resistance (Input to Output) ¹	R _{I-O}		10 ¹³		Ω	
Capacitance (Input to Output) ¹	C _{I-O}		0.9		pF	f = 1 MHz
Input Capacitance ²	C _I		4.0		pF	

¹ The device is considered a 2-terminal device: Pin 1 through Pin 4 are shorted together, and Pin 5 through Pin 8 are shorted together.

² Input capacitance is from any input data pin to ground.

REGULATORY INFORMATION

See Table 10 and the Insulation Lifetime section for the recommended maximum working voltages for specific cross isolation waveforms and insulation levels. The ADM3058E is pending approval by the organizations listed in Table 5.

Table 5.

UL (Pending)	CSA (Pending)	VDE (Pending)	CQC (Pending)
UL1577 Component Recognition Program ¹ Single Protection, 5.7 kV rms Isolation Voltage	Approved under CSA Component Acceptance Notice 5A CSA 60950-1-07+A1+A2 and IEC 60950-1, second edition, +A1+A2: Basic insulation at 830 V rms (1137 V peak) Reinforced insulation at 415 V rms (587 V peak) IEC 60601-1 Edition 3.1: Reinforced insulation (2 means of patient protection (MOPP)), 261V rms (291 V dc) CSA 61010-1-12 and IEC 61010-1 third edition: Basic insulation at: 300 V rms mains, 830 V secondary (1174 V peak) Reinforced insulation at: 300 V rms mains, 415 V secondary (587 V peak)	DIN V VDE V 0884-11 (VDE V 0884-11):2017-01 ² Reinforced insulation, 1500 V peak, V _{OTM} = 8000 V	Certified under CQC11-471543-2012 GB4943.1-2011 Basic insulation at 830 V rms (1137 V peak) Reinforced insulation at 415 V rms (587 V peak)
File E214100	File 205078	File 2471900-4880-0001	File (pending)

¹ In accordance with UL 1577, each ADM3058E is proof tested by applying an insulation test voltage ≥ 6840 V rms for 1 sec.

² In accordance with DIN V VDE V 0884-11, each product is proof tested by applying an insulation test voltage ≥ 2813 V peak for 1 sec (partial discharge detection limit = 5 pC). The * marking branded on the component designates DIN V VDE V 0884-11 approval.

DIN V VDE V 0884-11 (VDE V 0884-11) INSULATION CHARACTERISTICS (PENDING)

These isolators are suitable for reinforced electrical isolation only within the safety limit data. Protective circuits ensure the maintenance of the safety data.

Table 6. ADM3058E VDE Characteristics

Description	Test Conditions/Comments	Symbol	Characteristic	Unit
Installation Classification per DIN VDE 0110 For Rated Mains Voltage ≤ 150 V rms For Rated Mains Voltage ≤ 300 V rms For Rated Mains Voltage ≤ 600 V rms			I to IV I to IV I to IV	
Climatic Classification			40/125/21	
Pollution Degree per DIN VDE 0110, Table 1			2	
Maximum Working Insulation Voltage Reinforced		V _{IORM}	1500	V peak
Basic, DC Working Voltage	See the Absolute Maximum Ratings section and Table 10 for the maximum continuous working voltage for ac bipolar, ac unipolar, and dc voltages, basic and reinforced insulation, and 50-year lifetime to 1% failure	V _{IORM}	1500	V peak
Input to Output Test Voltage, Method B1	V _{IORM} × 1.875 = V _{pd(m)} , 100% production test, t _{ini} = t _m = 1 sec, partial discharge < 5 pC	V _{pd(m)}	2813	V peak
Input to Output Test Voltage, Method A After Environmental Tests Subgroup 1	V _{IORM} × 1.5 = V _{pd(m)} , t _{ini} = 60 sec, t _m = 10 sec, partial discharge < 5 pC	V _{pd(m)}	2250	V peak
After Input and/or Safety Test Subgroup 2 and Subgroup 3	V _{IORM} × 1.2 = V _{pd(m)} , t _{ini} = 60 sec, t _m = 10 sec, partial discharge < 5 pC		1800	V peak
Highest Allowable Overvoltage Impulse		V _{IOTM}	8000	V peak
	1.2 μs rise time, 50 μs, 50% fall time in air to the preferred sequence	V _{IMPULSE}	8000	V peak
Surge Isolation Test Voltage	Peak voltage (V _{PEAK}) = 12.8 kV, 1.2 μs rise time, 50 μs, and 50% fall time	V _{IOSM}	8000	V peak
Safety Limiting Values	Maximum value allowed in the event of a failure (see Figure 4)			
Maximum Junction Temperature		T _S	150	°C
Total Power Dissipation at 25°C		P _S	1.28	W
Insulation Resistance at T _S	Test voltage = 500 V	R _S	>10 ⁹	Ω

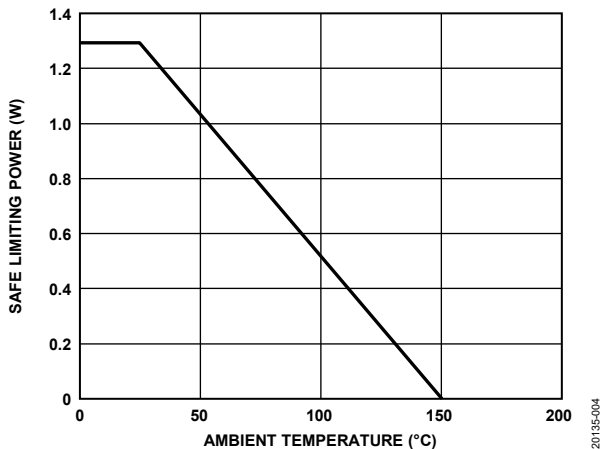

Figure 4. Thermal Derating Curve, Dependence of Safety Limiting Values with Ambient Temperature per DIN V VDE V 0884-11 (See the Thermal Resistance Section for Additional Information)

ABSOLUTE MAXIMUM RATINGS

Pin voltages with respect to GND₁/GND₂ are on same side, unless otherwise noted.

Table 7.

Parameter	Rating
V _{DD1} , V _{DD2}	−0.5 V to +6 V
Logic Side Input and Output: TXD, RXD	−0.5 V to V _{DD1} + 0.5 V
CANH, CANL	−40 V to +40 V
Temperature	
Industrial Operating Range	−40°C to +125°C
Storage Range	−65°C to +150°C
Maximum Junction (T _j)	150°C
Moisture Sensitivity Level (MSL)	3

Stresses at or above those listed under Absolute Maximum Ratings may cause permanent damage to the product. This is a stress rating only; functional operation of the product at these or any other conditions above those indicated in the operational section of this specification is not implied. Operation beyond the maximum operating conditions for extended periods may affect product reliability.

THERMAL RESISTANCE

Thermal performance is directly linked to PCB design and operating environment. Careful attention to PCB thermal design is required.

θ_{JA} is the natural junction to ambient thermal resistance measured in a one cubic foot sealed enclosure.

Table 8. Thermal Resistance

Package Type ¹	θ _{JA}	Unit
RI-8-1	97	°C/W

¹ The thermocouple is located at the center of the package underside, and the test was conducted on a 4-layer board with thin traces. See the Thermal Analysis section for the thermal model definitions.

Table 10. Maximum Continuous Working Voltage¹

Parameter	Insulation Rating (20-Year Lifetime) ²	VDE 0884-11 Lifetime Conditions Fulfilled
AC Voltage		
Bipolar Waveform		
Reinforced Insulation	1060 V peak	Lifetime limited by insulation lifetime per VDE-0884-11
DC Voltage		
Basic Insulation	1660 V peak	Lifetime limited by package creepage per IEC 60664-1
Reinforced Insulation	830 V peak	Lifetime limited by package creepage per IEC 60664-1

¹ The maximum continuous working voltage refers to the continuous voltage magnitude imposed across the isolation barrier. See the Insulation Lifetime section for more details.

² Insulation capability without regard to creepage limitations. Working voltage may be limited by the PCB creepage when considering rms voltages for components soldered to a PCB (assumes Material Group I up to 1250 V rms), or by the SOIC_IC package creepage of 8.3 mm, when considering rms voltages for Material Group II.

ELECTROSTATIC DISCHARGE (ESD) RATINGS

The following ESD information is provided for handling of ESD sensitive devices in an ESD protected area only.

Human body model (HBM) per ANSI/ESDA/JEDEC JS-001.

International Electrotechnical Commission (IEC) electromagnetic compatibility: Part 4-2 (IEC) per IEC 61000-4-2.

ESD Ratings for ADM3058E

Table 9. ADM3058E, 8-Lead SOIC_IC

ESD Model	Withstand Threshold (V)	Class
HBM ¹	±4 kV	3A
IEC ²	±8 kV (across isolation barrier with respect to GND ₁)	Level 4
IEC ³	±8 kV (contact discharge with respect to GND ₂)	Level 4
	±15 kV (air discharge with respect to GND ₂)	Level 4

¹ All pins, 1.5 kΩ, 100 pF.

² Across the isolation barrier, GND₂ to GND₁.

³ CANH/CANL.

ESD CAUTION



ESD (electrostatic discharge) sensitive device.

Charged devices and circuit boards can discharge without detection. Although this product features patented or proprietary protection circuitry, damage may occur on devices subjected to high energy ESD. Therefore, proper ESD precautions should be taken to avoid performance degradation or loss of functionality.

PIN CONFIGURATION AND FUNCTION DESCRIPTIONS

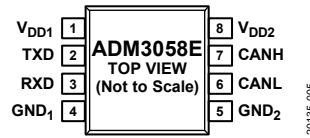

Figure 5. Pin Configuration

Table 11. Pin Function Descriptions

Pin No.	Mnemonic	Description
1	V _{DD1}	Power Supply, Logic Side, 1.7 V to 5.5 V. V _{DD1} requires a 0.1 μ F decoupling capacitor.
2	TXD	Driver Input Data.
3	RXD	Receiver Output Data.
4	GND ₁	Ground, Logic Side.
5	GND ₂	Ground, Bus Side.
6	CANL	CAN Low Input and Output.
7	CANH	CAN High Input and Output.
8	V _{DD2}	Power Supply, Bus Side, 4.5 V to 5.5 V. V _{DD2} requires a 0.1 μ F decoupling capacitor.

Table 12. Operational Truth Table

V _{DD1}	V _{DD2}	TXD	Mode	RXD	CANH or CANL
On	On	Low	Normal	Low	Dominant (limited by t _{DT})
On	On	High	Normal	High per bus	Recessive and set by bus
Off	On	Don't care	Normal	Indeterminate	Recessive and set by bus
On	Off	Don't care	Transceiver off	High	High-Z

TYPICAL PERFORMANCE CHARACTERISTICS

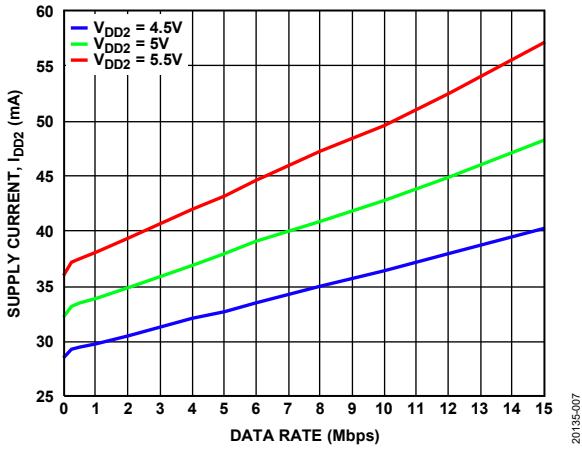

Figure 6. Supply Current (I_{DD2}) vs. Data Rate

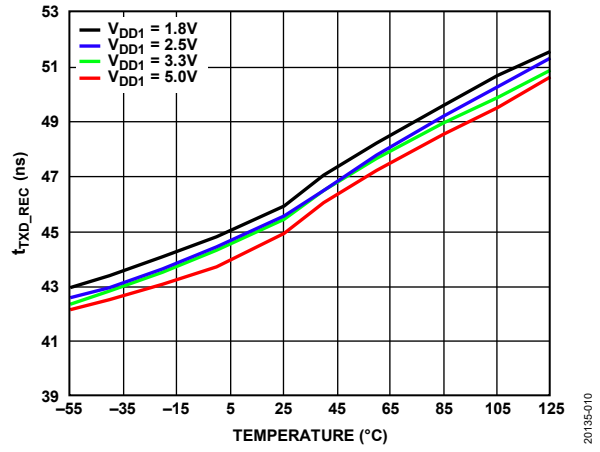

Figure 9. t_{TXD_REC} vs. Temperature

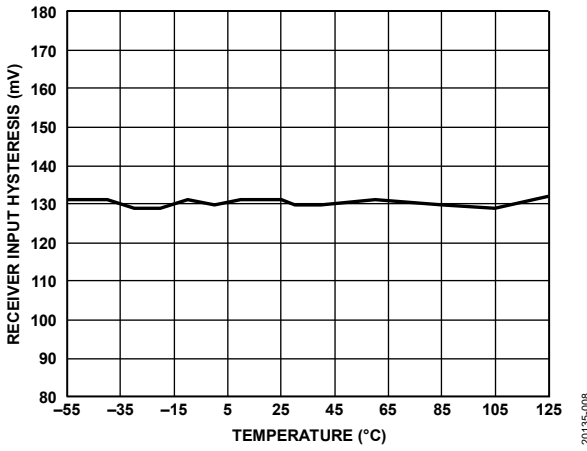

Figure 7. Receiver Input Hysteresis vs. Temperature

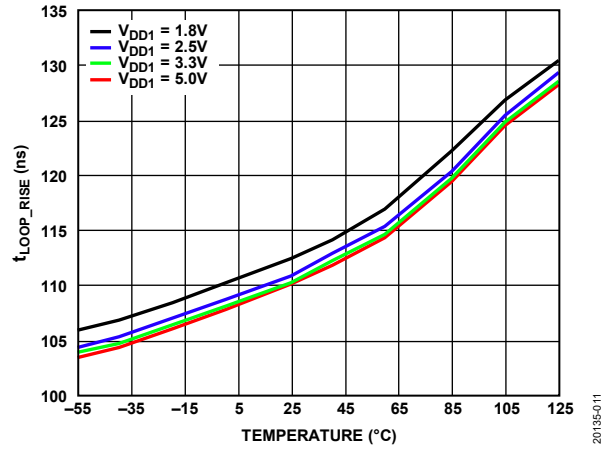

Figure 10. t_{LOOP_RISE} vs. Temperature

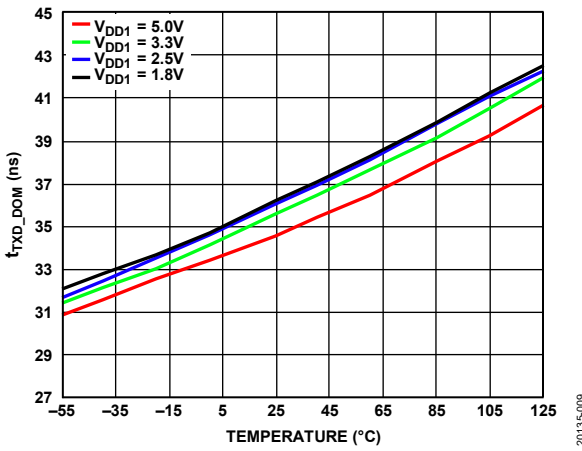

Figure 8. t_{TXD_DOM} vs. Temperature

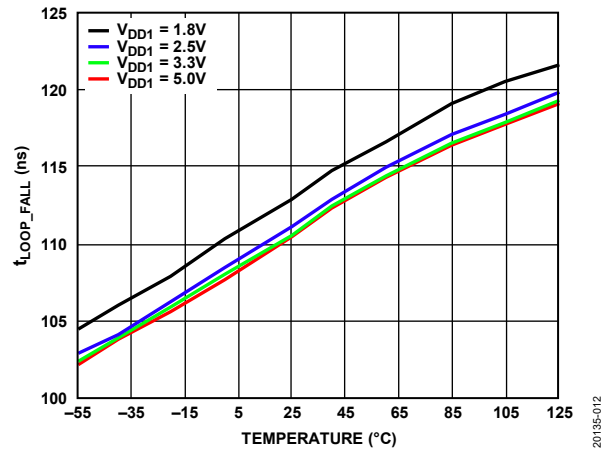

Figure 11. t_{LOOP_FALL} vs. Temperature

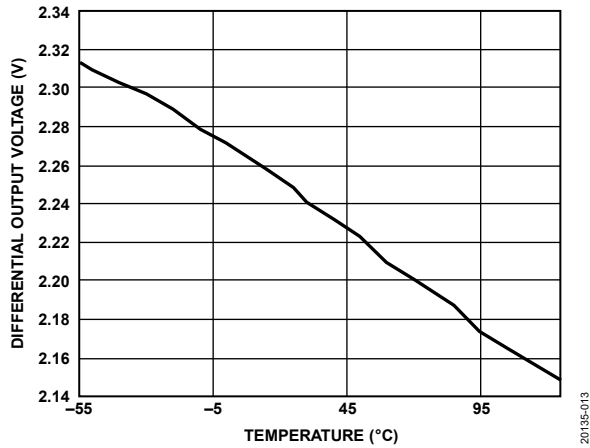

Figure 12. Differential Output Voltage vs. Temperature, $R_L = 60\ \Omega$

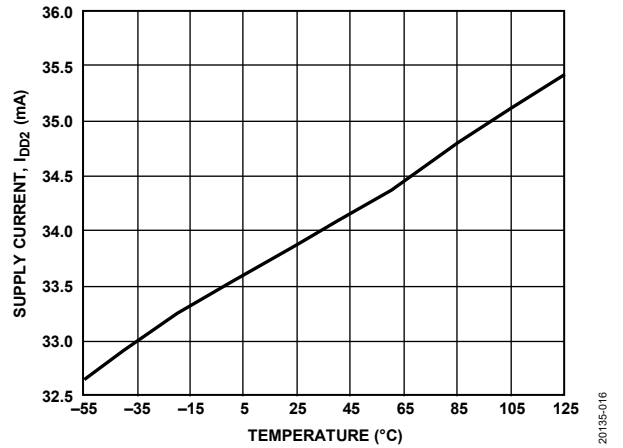

Figure 15. Supply Current (I_{DD2}) vs. Temperature

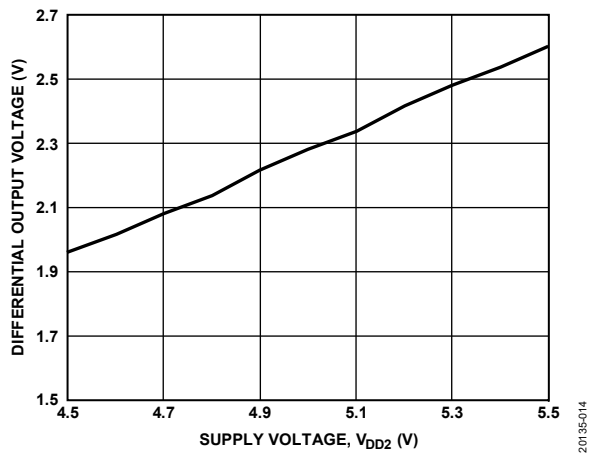

Figure 13. Differential Output Voltage vs. Supply Voltage (V_{DD2}), $R_L = 60\ \Omega$

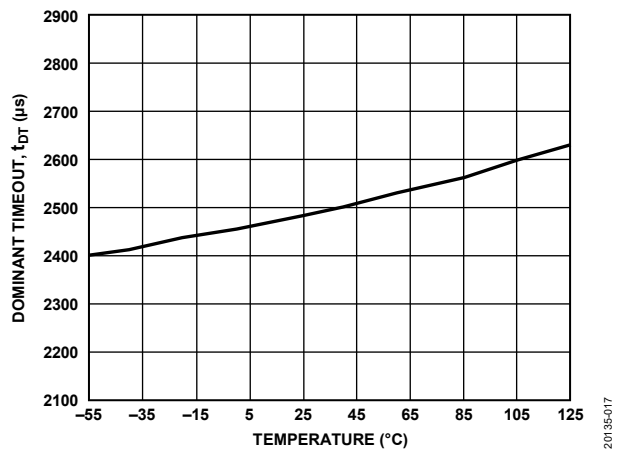

Figure 16. Dominant Timeout (t_{DT}) vs. Temperature

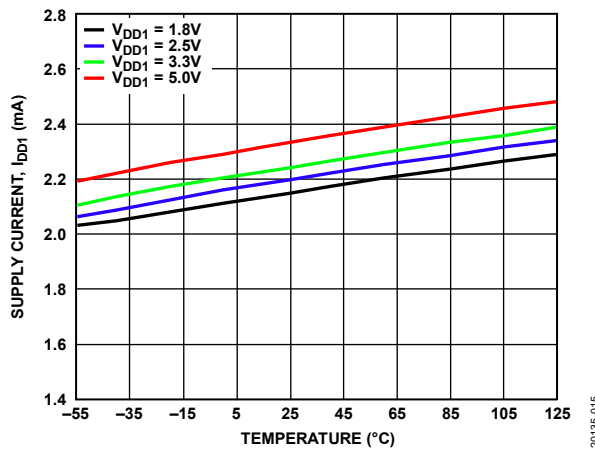

Figure 14. Supply Current (I_{DD1}) vs. Temperature

TEST CIRCUITS

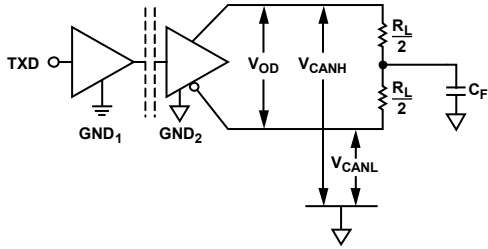

Figure 17. Driver Voltage Measurement

20135-018

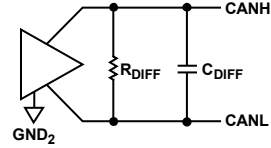

Figure 20. R_{DIFF} and C_{DIFF} Measured in Recessive State, Bus Disconnected

20135-021

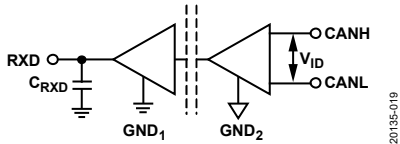

Figure 18. Receiver Voltage Measurement

20135-019

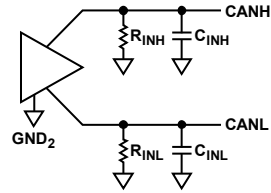
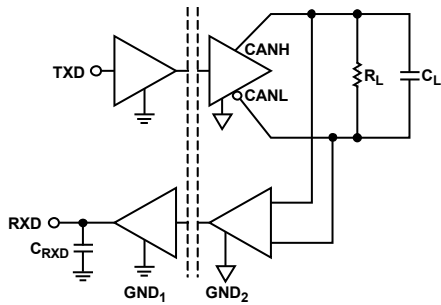

Figure 21. Input Resistance (R_{INx}) and Input Capacitance (C_{INx}) Measured in Recessive State, Bus Disconnected

20135-022



NOTES
1. 1% TOLERANCE FOR ALL RESISTORS AND CAPACITORS.
Figure 19. Switching Characteristics Measurements

20135-020

TERMINOLOGY

I_{DD1}

I_{DD1} is the current drawn by the V_{DD1} pin.

I_{DD2}

I_{DD2} is the current drawn by the V_{DD2} pin.

V_{OD} and V_{ID}

V_{OD} and V_{ID} are the differential voltages from the transmitter or at the receiver on the CANH and CANL pins.

t_{TXD_DOM}

t_{TXD_DOM} is the propagation delay from a low signal on TXD to transition the bus to a dominant state.

t_{TXD_REC}

t_{TXD_REC} is the propagation delay from a high signal on TXD to transition the bus to a recessive state.

t_{LOOP_FALL}

t_{LOOP_FALL} is the propagation delay of a low signal on the TXD pin to the bus dominant. t_{LOOP_FALL} transitions low on the RXD pin.

t_{LOOP_RISE}

t_{LOOP_RISE} is the propagation delay of a high signal on TXD to the bus recessive. t_{LOOP_RISE} transitions high on the RXD pin.

t_{BIT_TXD}

t_{BIT_TXD} is the bit time at the TXD pin as transmitted by the CAN controller. See Figure 2 for level definitions.

t_{BIT_BUS}

t_{BIT_BUS} is the bit time as transmitted by the transceiver to the bus. When compared with a given t_{BIT_TXD}, a measure of bit symmetry from the TXD digital isolation channel and CAN transceiver can be determined. See Figure 2 for level definitions.

t_{BIT_RXD}

t_{BIT_RXD} is the bit time on the RXD output pin, which can be compared with t_{BIT_TXD} for a round trip measure of pulse width distortion through the TXD digital isolation channel, the CAN transceiver, and back through the RXD isolation channel.

THEORY OF OPERATION

CAN TRANSCEIVER OPERATION

The ADM3058E facilitates communication between a CAN controller and the CAN bus. The CAN controller and the ADM3058E communicate with standard 1.8 V, 2.5 V, 3.3 V, or 5.0 V CMOS levels. The internal transceiver translates the CMOS levels to and from the CAN bus.

The CAN bus has two states: dominant and recessive. The recessive state is present on the bus when the differential voltage between CANH and CANL is less than 0.5 V. In the recessive state, both the CANH pin and CANL pin are set to high impedance and are loosely biased to a single-ended voltage of 2.5 V. A dominant state is present on the bus when the differential voltage between CANH and CANL is greater than 1.5 V. The transceiver transmits a dominant state by driving the single-ended voltage of the CANH line to 3.5 V and the CANL pin to 1.5 V. The recessive and dominant states correspond to CMOS high and CMOS low, respectively, on the RXD pin and TXD pin.

A dominant state from another node overwrites a recessive state on the bus. A CAN frame can be set for higher priority by using a longer string of dominant bits to gain control of the CAN bus during the arbitration phase. While transmitting, a CAN transceiver also reads back the state of the bus. When a CAN controller receives a dominant state while transmitting a recessive state during arbitration, the CAN controller surrenders the bus to the node still transmitting the dominant state. The node that gains control during the arbitration phase reads back only its own transmission. This interaction between recessive and dominant states allows competing nodes to negotiate for control of the bus while avoiding contention between nodes.

Industrial applications can have long cable runs. These long runs may have differences in local earth potential. Different sources may also power nodes. The ADM3058E transceiver has a ± 25 V common-mode range (CMR) that exceeds the ISO11898-2 requirement and further increases the tolerance to ground variation.

See the [AN-1123 Application Note](#) for additional information on CAN.

SIGNAL ISOLATION

The ADM3058E device provides galvanic signal isolation implemented on the logic side of the interface. The RXD and TXD channels are isolated using a low propagation delay on/off keying (OOK) architecture with *i*Coupler digital isolation technology.

The low propagation delay isolation, quick transceiver conversion speeds, and integrated form factor are critical for longer cable lengths, higher data speeds, and reducing the total solution board space. The ADM3058E isolated transceiver reduces solution board space while increasing data transfer rates over discrete optocoupler and transceiver solutions.

INTEGRATED AND CERTIFIED IEC ELECTROMAGNETIC COMPATIBILITY (EMC) SOLUTION

Typically, designers must add protections against harsh operating environments while also making the product as small as possible. To reduce the board space and the design efforts needed to meet system level ESD standards, the ADM3058E isolated transceiver has robust protection circuitry on chip for the CANH and CANL lines.

± 40 V MISWIRE PROTECTION

High voltage miswire events commonly occur when the system power supply is connected directly to the CANH and the CANL bus lines during assembly. Supplies can also be shorted by accidental damage to the field bus cables while the system is operating. Accounting for inductive kick and switching effects, the ADM3058E isolated transceiver CAN bus lines are protected against these miswire or shorting events in systems with up to nominal 24 V supplies. The CANH and CANL signal lines can withstand a continuous supply short with respect to GND₂ or between the CAN bus lines without damage. This level of protection applies when the device is either powered or unpowered.

DOMINANT TIMEOUT

The ADM3058E features a dominant timeout (t_{DT} in Figure 3). A TXD line shorted to ground or malfunctioning CAN controller are examples of how a single node can indefinitely prevent further bus traffic. t_{DT} limits how long the dominant state can transmit to the CAN bus by the transceiver. The TXD function restores when the line is presented with a logic low.

The t_{DT} minimum also inherently creates a minimum data rate. Under normal operation, the CAN protocol allows five consecutive bits of the same polarity before stuffing a bit of opposite polarity into the transmitting bit sequence. When an error is detected, the CAN controller purposely violates the bit stuffing rules by producing six consecutive dominant bits. At any given data rate, the CAN controller must transmit as many as 11 consecutive dominant bits to effectively limit the ADM3058E minimum data rate to 9600 bps.

FAIL-SAFE FEATURES

In cases where the TXD input pin is allowed to float to prevent bus traffic interruption, the TXD input channel has an internal pull-up to the V_{DD1} pin. The pull-up holds the transceiver in the recessive state.

THERMAL SHUTDOWN

The integrated transceiver is designed with thermal shutdown circuitry to protect the device from excessive power dissipation during fault conditions. Shorting the driver outputs to a low impedance source can result in high driver currents. The thermal

sensing circuitry detects the increase in die temperature under this condition and disables the driver outputs. The circuitry disables the driver outputs when the die temperature reaches 175°C. The drivers are enabled after the die has cooled.

APPLICATIONS INFORMATION

RADIATED EMISSIONS AND PCB LAYOUT

The ADM3058E isolated CAN transceivers with integrated dc-to-dc converters pass EN 55022, Class B by 6 dB on a simple 2-layer PCB design. Neither stitching capacitance nor high voltage surface-mount technology (SMT) safety capacitors are required to meet this emission level.

PCB LAYOUT

The ADM3058E isolated CAN transceiver requires no external interface circuitry for the logic interfaces. Power supply bypassing is required at the logic input supply (V_{DD1}), and the shared CAN transceiver and digital isolator supply pin (V_{DD2}). The recommended bypass capacitor value is 0.1 μ F. Note that low effective series resistance (ESR) bypass capacitors are required and must be placed as close to the chip pads as possible. The total lead length between both ends of the capacitor and the input power supply pin must not exceed 10 mm.

In applications involving high common-mode transients, minimize board coupling across the isolation barrier. Design the board layout so that any coupling that does occur equally affects all pins on a given component side. Failure to ensure this equal coupling can cause voltage differences between pins exceeding the absolute maximum ratings of the device, thereby leading to latch-up or permanent damage.

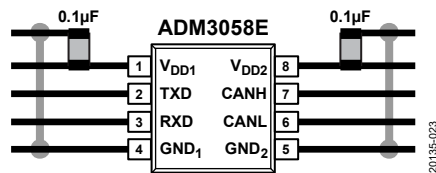

Figure 22. Recommended PCB Layout

THERMAL ANALYSIS

The ADM3058E device consists of three internal die attached to a split lead frame. For the purposes of thermal analysis, the die are treated as a thermal unit, with the highest junction temperature reflected in the θ_{JA} value from Table 8. The θ_{JA} value is based on measurements taken with the devices mounted on a JEDEC standard, 4-layer board with fine width traces and still air.

INSULATION LIFETIME

All insulation structures eventually break down when subjected to voltage stress over a sufficiently long period of time. The rate of insulation degradation is dependent on the characteristics of the voltage waveform applied across the insulation as well as on the materials and material interfaces.

The two types of insulation degradation of primary interest are breakdown along surfaces exposed to air and insulation wear out. Surface breakdown is the phenomenon of surface tracking and is the primary determinant of surface creepage requirements in system level standards. Insulation wear out is the phenomenon where charge injection or displacement

currents inside the insulation material cause long-term insulation degradation.

SURFACE TRACKING

Surface tracking is addressed in electrical safety standards by setting a minimum surface creepage based on the working voltage, the environmental conditions, and the properties of the insulation material. Safety agencies perform characterization testing on the surface insulation of components, allowing the components to be categorized in different material groups. Lower material group ratings are more resistant to surface tracking and can therefore provide adequate lifetime with smaller creepage. The minimum creepage for a given working voltage and material group is in each system level standard and is based on the total rms voltage across the isolation, pollution degree, and material group.

The material group and creepage for the ADM3058E isolator is listed in Table 3 for the 8-lead, wide body SOIC package.

INSULATION WEAR OUT

The lifetime of insulation caused by wear out is determined by its thickness, material properties, and the voltage stress applied. It is important to verify that the product lifetime is adequate at the application working voltage. The working voltage supported by an isolator for wear out may not be the same as the working voltage supported for tracking. The working voltage applicable to tracking is specified in most standards.

Testing and modeling have shown that the primary driver of long-term degradation is displacement current in the polyimide insulation causing incremental damage. The stress on the insulation can be broken down into broad categories, such as dc stress, which causes little wear out because there is no displacement current, and an ac component time varying voltage stress, which causes wear out.

The ratings in certification documents are usually based on 60 Hz sinusoidal stress because this reflects isolation from line voltage. Many practical applications have combinations of 60 Hz ac and dc across the barrier, as shown in Equation 1. Because only the ac portion of the stress causes wear out, the equation can be rearranged to solve for the ac rms voltage, as shown in Equation 2. For insulation wear out with the polyimide materials used in this product, the ac rms voltage determines the product lifetime.

$$V_{RMS} = \sqrt{V_{AC\,RMS}^2 + V_{DC}^2} \quad (1)$$

or

$$V_{AC\,RMS} = \sqrt{V_{RMS}^2 - V_{DC}^2} \quad (2)$$

where:

V_{RMS} is the total rms working voltage.

$V_{AC\,RMS}$ is the time varying portion of the working voltage.

V_{DC} is the dc offset of the working voltage.

