

FEATURES

RF input frequency range: 17.5 GHz to 24 GHz
IF output frequency range: 2.5 GHz to 3.5 GHz
LO input frequency range: 7 GHz to 13.5 GHz
Conversion gain (with hybrid): 15 dB typical
SSB noise figure: 2.5 dB typical
Input IP3: 3 dBm typical
Input P1dB: -5 dBm typical
25 dB of image rejection
Single-ended, 50 Ω RF and LO input ports
Exposed pad, 4.9 mm \times 4.9 mm, 32-terminal LCC

APPLICATIONS

Point to point microwave radios
Radars and electronic warfare systems
Instrumentation, automatic test equipment (ATE)
Satellite communications

GENERAL DESCRIPTION

The ADMV1012 is a compact, gallium arsenide (GaAs) design, monolithic microwave integrated circuit (MMIC), in phase/quadrature (I/Q) downconverter in a RoHS compliant package optimized for point to point microwave radio designs that operate in the 17.5 GHz to 24 GHz input frequency range.

The ADMV1012 provides 15 dB of conversion gain with 25 dB of image rejection, and 2.5 dB noise figure. The ADMV1012 uses a radio frequency (RF) low noise amplifier (LNA) followed by an I/Q, double balanced mixer, where a driver amplifier drives the local oscillator (LO) with a $\times 2$ multiplier. IF1 and IF2 mixer quadrature outputs are provided, and an external 90° hybrid is required to select the required sideband.

FUNCTIONAL BLOCK DIAGRAM

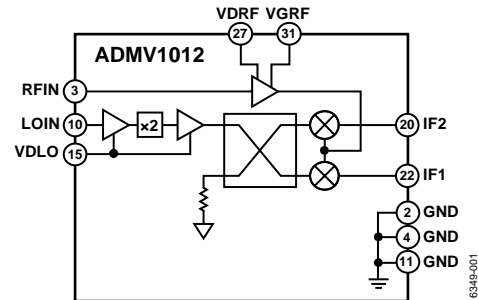

Figure 1.

The I/Q mixer topology reduces the need for filtering of unwanted sideband. The ADMV1012 is a much smaller alternative to hybrid style, double sideband (DSB) downconverter assemblies and eliminates the need for wire bonding by allowing the use of surface-mount manufacturing assemblies.

The ADMV1012 downconverter comes in a compact, thermally enhanced, 4.9 mm \times 4.9 mm, 32-terminal LCC. The ADMV1012 operates over the -40°C to $+85^{\circ}\text{C}$ temperature range.

TABLE OF CONTENTS

Features	1	Return Loss Performance	12
Applications	1	Spurious Performance	13
Functional Block Diagram	1	M × N Spurious Performance for LO = 0 dBm	13
General Description	1	Theory of Operation	14
Revision History	2	LO Driver Amplifier	14
Specifications	3	Mixer	14
Absolute Maximum Ratings	4	LNA	14
Thermal Resistance	4	Applications Information	15
ESD Caution	4	Typical Application Circuit	15
Pin Configuration and Function Descriptions	5	Evaluation Board Information	16
Typical Performance Characteristics	6	Bill of Materials	18
Upper Sideband (Low-Side LO)	6	Outline Dimensions	19
Lower Sideband (High-Side LO)	8	Ordering Guide	19
IF Bandwidth	10		
Leakage Performance	11		

REVISION HISTORY

2/2018—Rev. 0 to Rev. A

Changes to Features Section, General Description Section, and Figure 1	1
Changes to Table 1	3
Changes to Table 2	4
Added Thermal Resistance Section and Table 3; Renumbered Sequentially	4
Changes to Figure 2 and Table 4	5
Changes to Figure 3 and Figure 6	6
Changes to Figure 12	7
Changes to Figure 24, Figure 25, and Figure 26	10
Changes to Figure 27 through Figure 30	11

Changed M × N Spurious Performance for LO = 4 dBm Section to M × N Spurious Performance for LO = 0 dBm Section	13
Changes to M × N Spurious Performance for LO = 0 dBm Section	13
Changes to LO Driver Amplifier Section	14
Changes to Applications Information Section and Figure 34	15
Changes to Power-On Sequence Section	16
Changes to Figure 37	17
Changes to Table 6	18
Changes to Ordering Guide	19

10/2017—Revision 0: Initial Version

SPECIFICATIONS

Data taken at $V_{DRF} = 3\text{ V}$, $V_{DLO} = 3\text{ V}$, $LO = -4\text{ dBm} \leq LO \leq +4\text{ dBm}$, $-40^\circ\text{C} \leq T_A \leq +85^\circ\text{C}$, with a Mini-Circuits® QCN-45+ power splitter for both upper sideband (low-side LO) and lower sideband (high-side LO), unless otherwise noted.

Table 1.

Parameter	Symbol	Test Conditions/Comments	Min	Typ	Max	Unit
INPUT FREQUENCY RANGE						
Radio Frequency	RF		17.5		24	GHz
Local Oscillator	LO		7		13.5	GHz
LO AMPLITUDE						
			-4	0	+4	dBm
OUTPUT FREQUENCY RANGE						
Intermediate Frequency	IF		2.5		3.5	GHz
RF PERFORMANCE						
Conversion Gain		With hybrid	10.5	15	20	dB
Single Sideband (SSB) Noise Figure	SSB NF					
Lower Sideband (High-Side LO)				2.1	3.5	dB
Upper Sideband (Low-Side LO)				2.5	4	dB
Input Third-Order Intercept	IP3	At -20 dBm/tone	0	3		dBm
Input 1 dB Compression Point	P1dB		-9	-5		dBm
Image Rejection			20	25		dB
Leakage						
LO to RF				-37	-25	dBm
LO to IF				-40	-25	dBm
2× LO to IF				-40	-25	dBm
IM3 at Input						
-20 dBm Input Power		-23 dBm per tone	46	52		dBc
-25 dBm Input Power		-28 dBm per tone	52	60		dBc
-30 dBm Input Power		-33 dBm per tone	56	70		dBc
Return Loss						
RF Input				-11	-10	dB
IF Output				-23	-10	dB
LO Input				-11	-10	dB
POWER INTERFACE						
RF LNA Bias Voltage	VDRF			3	3.5	V
LO Amplifier Bias Voltage	VDLO			3	3.5	V
RF LNA Gate Voltage	VGRF		-1.8		-0.4	
RF Amplifier Bias Current	IDRF	Adjust VGRF between -1.8 V to -0.4 V to get IDRF		68		mA
LO Amplifier Bias Current	IDLO			170		mA
RF Amplifier Gate Current	IGRF			<1		mA
Total Power				0.7	0.8	W

ABSOLUTE MAXIMUM RATINGS

Table 2.

Parameter	Rating
Supply Voltage	
VDLO	4 V
VGRF	0 V
VDRF – VGRF ¹	6 V
Input Power	
RF	15 dBm
LO	15 dBm
Maximum Junction Temperature	175°C
Maximum Power Dissipation	2 W
Lifetime at Maximum Junction Temperature (T _J)	>1 million hours
Operating Temperature Range	–40°C to +85°C
Storage Temperature Range	–65°C to +150°C
Lead Temperature (Soldering 60 sec)	260°C
Moisture Sensitivity Level (MSL) Rating	MSL3
Electrostatic Discharge (ESD) Sensitivity	
Human Body Model (HBM)	750 V
Field Induced Charged Device Model (FICDM)	500 V

¹ The maximum VDRF voltage and the minimum VGRF voltage is determined by this difference. If a maximum VDRF voltage of +4 V is required, then the minimum VGRF voltage is –2 V.

Stresses at or above those listed under Absolute Maximum Ratings may cause permanent damage to the product. This is a stress rating only; functional operation of the product at these or any other conditions above those indicated in the operational section of this specification is not implied. Operation beyond the maximum operating conditions for extended periods may affect product reliability.

THERMAL RESISTANCE

Thermal performance is directly linked to printed circuit board (PCB) design and operating environment. Careful attention to PCB thermal design is required.

θ_{JA} is thermal resistance, junction to ambient (°C/W), and θ_{JC} is thermal resistance, junction to case (°C/W).

Table 3. Thermal Resistance

Package Type	θ_{JA} ¹	θ_{JC}	Unit
E-32-1	33.4	34	°C/W

¹ See JEDEC standard JESD51-2 for additional information on optimizing the thermal impedance (PCB with 3 × 3 vias).

ESD CAUTION



ESD (electrostatic discharge) sensitive device. Charged devices and circuit boards can discharge without detection. Although this product features patented or proprietary protection circuitry, damage may occur on devices subjected to high energy ESD. Therefore, proper ESD precautions should be taken to avoid performance degradation or loss of functionality.

PIN CONFIGURATION AND FUNCTION DESCRIPTIONS

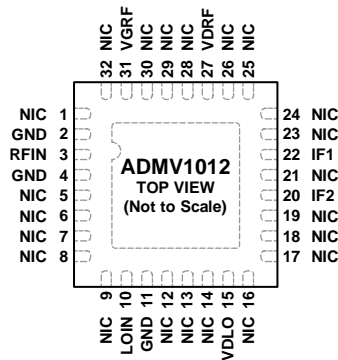

- NOTES**
1. NIC = NOT INTERNALLY CONNECTED. IT IS RECOMMENDED TO GROUND THESE PINS ON THE PCB.
 2. EXPOSED PAD. THE EXPOSED PAD MUST BE CONNECTED TO GND. GOOD RF AND THERMAL GROUNDING IS RECOMMENDED.

16349-002

Figure 2. Pin Configuration

Table 4. Pin Function Descriptions

Pin No.	Mnemonic	Description
1, 5 to 9, 12 to 14, 16 to 19, 21, 23 to 26, 28 to 30, 32	NIC	Not Internally Connected. It is recommended to ground these pins on the PCB.
2, 4, 11	GND	Ground.
3	RFIN	RF Input. This pin is ac-coupled internally and matched to 50 Ω single ended.
10	LOIN	LO Input. This pin is ac-coupled internally and matched to 50 Ω single ended.
15	VDLO	Power Supply Voltage for the LO Amplifier. Refer to the Applications Information section for the required external components and biasing.
20, 22	IF2, IF1	Quadrature IF Outputs. Matched to 50 Ω and ac coupled. No external dc block is required.
27	VDRF	Power Supply Voltage for the RF Amplifier. Refer to the Applications Information section for the required external components and biasing.
31	VGRF	Power Supply Gate Voltage for the RF Amplifier. Refer to the Applications Information section for the required external components and biasing.
	EPAD	Exposed Pad. The exposed pad must be connected to GND. Good RF and thermal grounding is recommended.

TYPICAL PERFORMANCE CHARACTERISTICS

UPPER SIDEBAND (LOW-SIDE LO)

Data taken at VDRF = 3 V, VDLO = 3 V, IDRF = 68 mA, LO = -4 dBm ≤ LO ≤ +4 dBm, -40°C ≤ T_A ≤ +85°C, with Mini-Circuits QCN-45+, power splitter as upper sideband (low-side LO), unless otherwise noted.

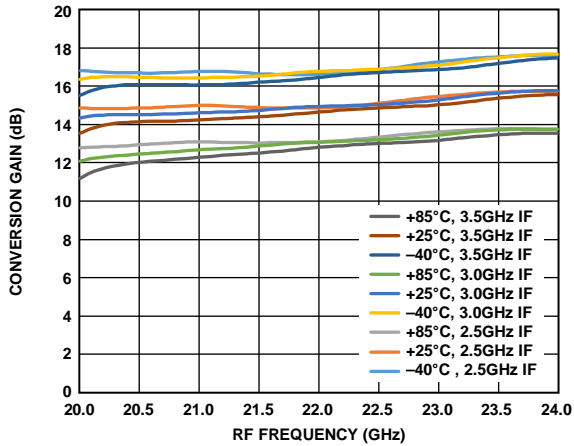

Figure 3. Conversion Gain vs. RF Frequency at Various Temperatures and Various IF Frequencies

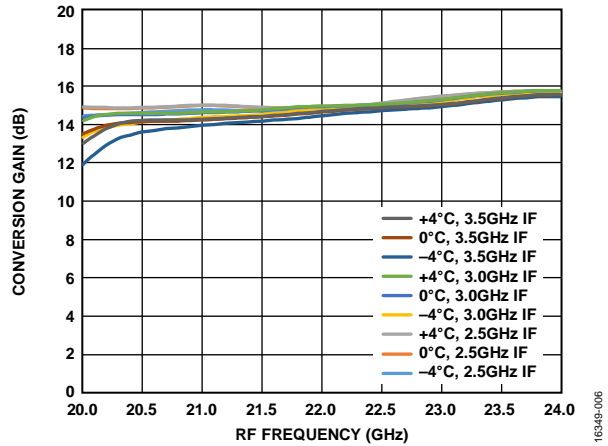

Figure 6. Conversion Gain vs. RF Frequency at Various LO Powers and Various IF Frequencies

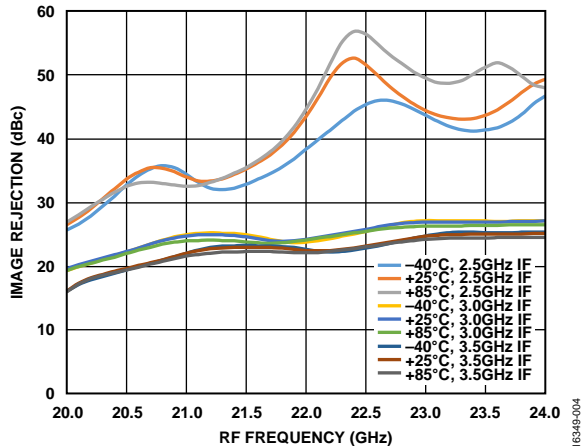

Figure 4. Image Rejection vs. RF Frequency at Various Temperatures and Various IF Frequencies

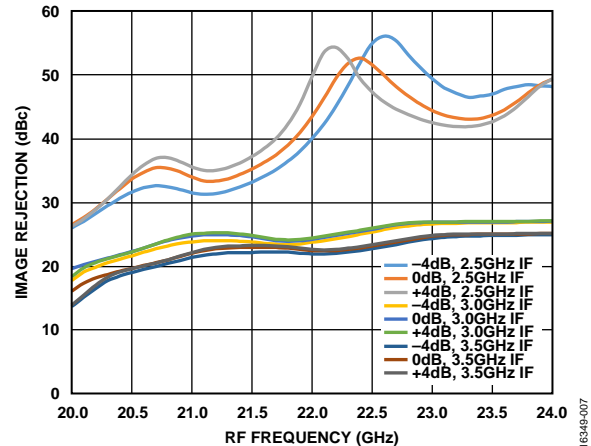

Figure 7. Image Rejection vs. RF Frequency at Various LO Powers and Various IF Frequencies

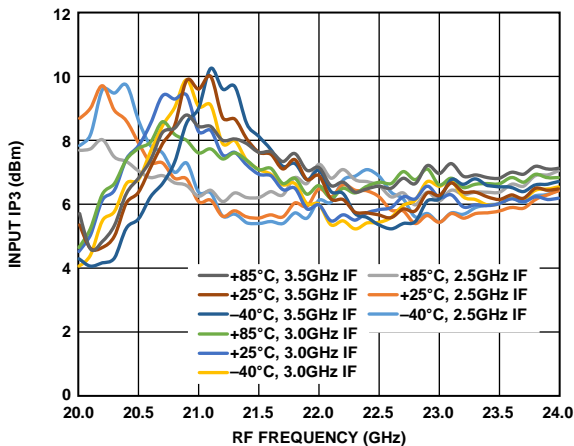

Figure 5. Input IP3 vs. RF Frequency at Various Temperatures and Various IF Frequencies

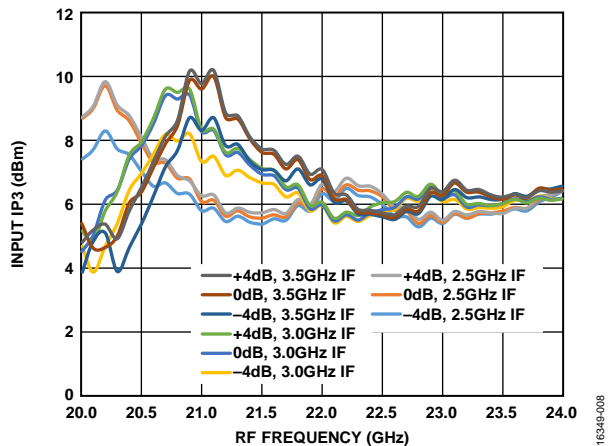

Figure 8. Input IP3 vs. RF Frequency at Various LO Powers and Various IF Frequencies

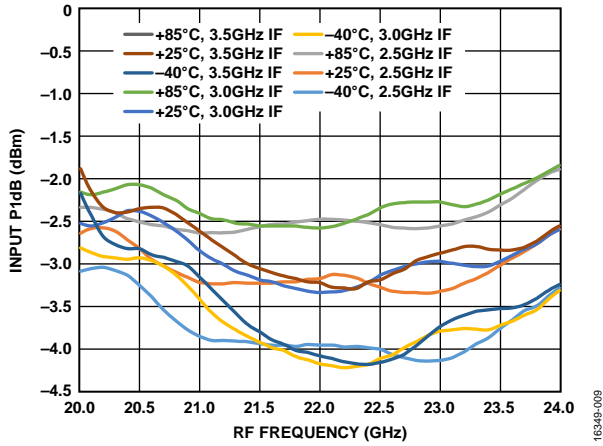

Figure 9. Input P1dB vs. RF Frequency at Various Temperatures and Various IF Frequencies

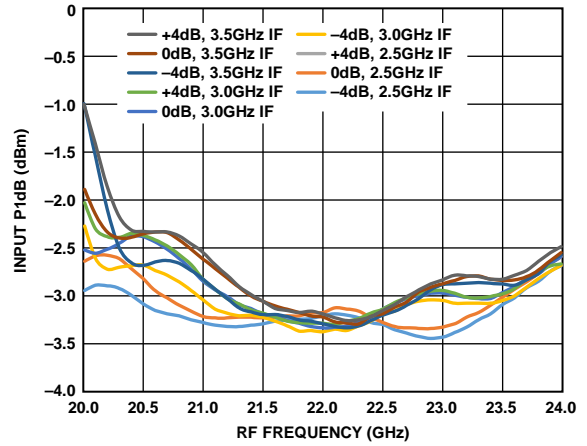

Figure 11. Input P1dB vs. RF Frequency at Various LO Powers and Various IF Frequencies

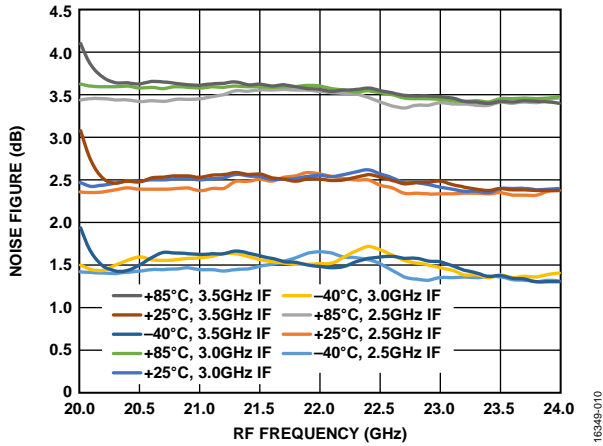

Figure 10. Noise Figure vs. RF Frequency at Various Temperatures and Various IF Frequencies

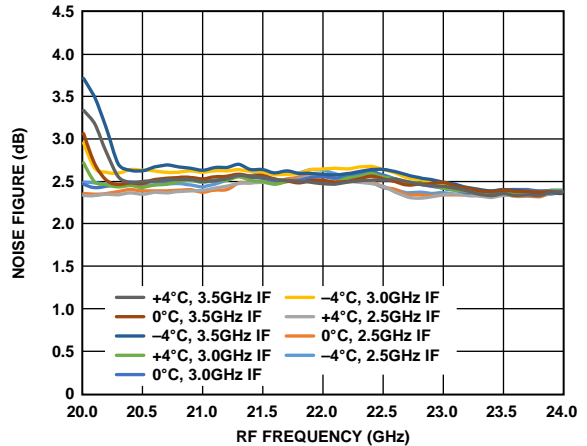

Figure 12. Noise Figure vs. RF Frequency at Various LO Powers and Various IF Frequencies

LOWER SIDEBAND (HIGH-SIDE LO)

Data taken at VDRF = 3 V, VDLO = 3 V, IDRf = 68 mA, LO = -4 dBm ≤ LO ≤ +4 dBm, -40°C ≤ T_A ≤ +85°C, with Mini-Circuits QCN-45+, power splitter as lower sideband (high-side LO), unless otherwise noted.

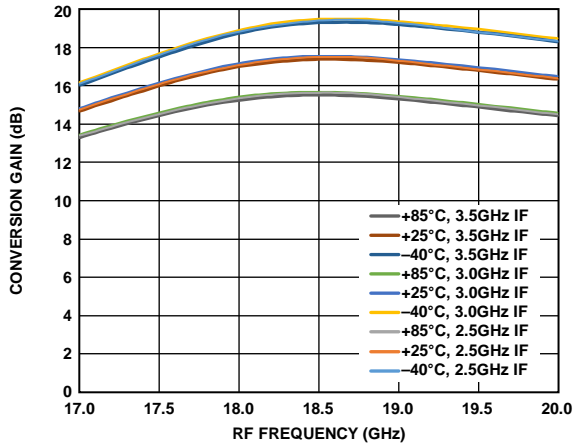

Figure 13. Conversion Gain vs. RF Frequency at Various Temperatures and Various IF Frequencies

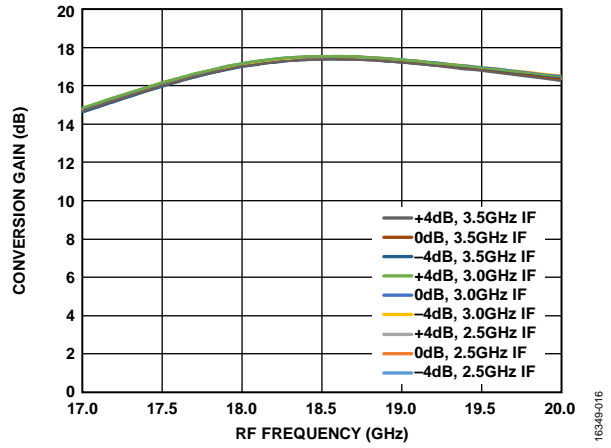

Figure 16. Conversion Gain vs. RF Frequency at Various LO Powers and Various IF Frequencies

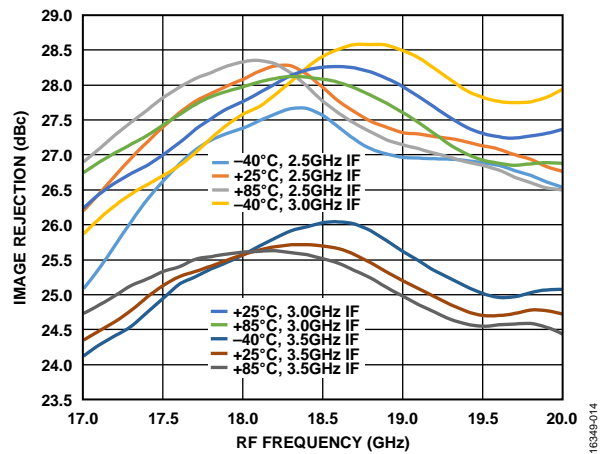

Figure 14. Image Rejection vs. RF Frequency at Various Temperatures and Various IF Frequencies

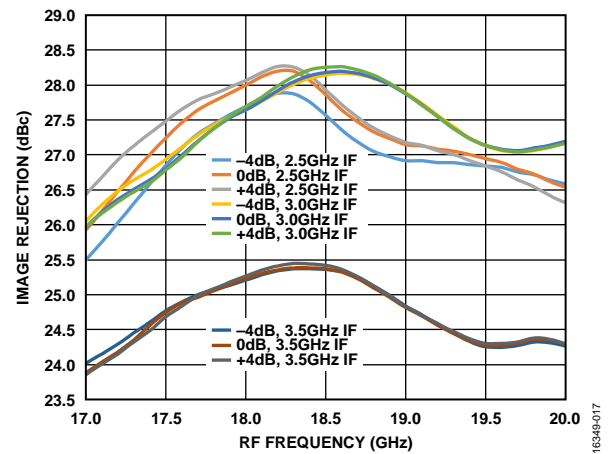

Figure 17. Image Rejection vs. RF Frequency at Various LO Powers and Various IF Frequencies

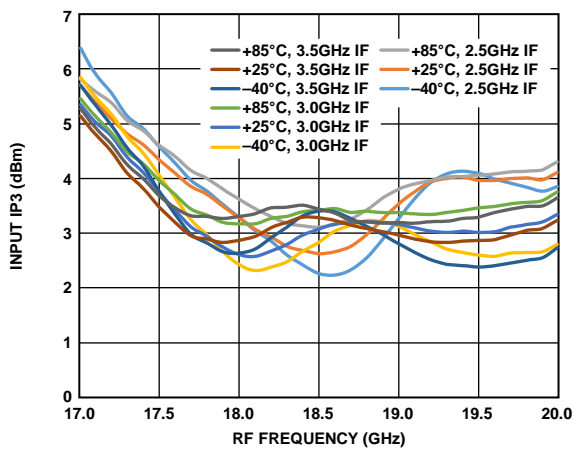

Figure 15. Input IP3 vs. RF Frequency at Various Temperatures and Various IF Frequencies

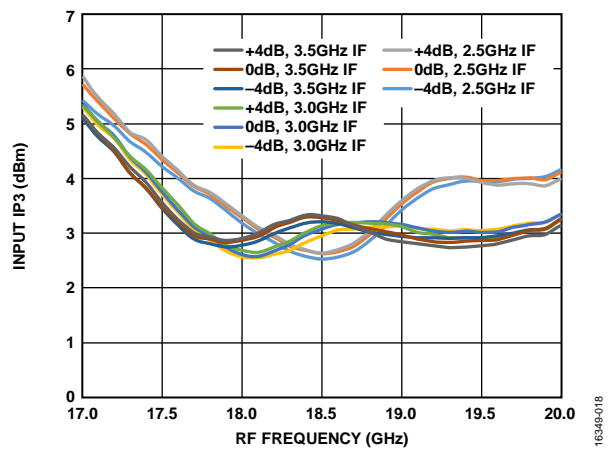

Figure 18. Input IP3 vs. RF Frequency at Various LO Powers and Various IF Frequencies

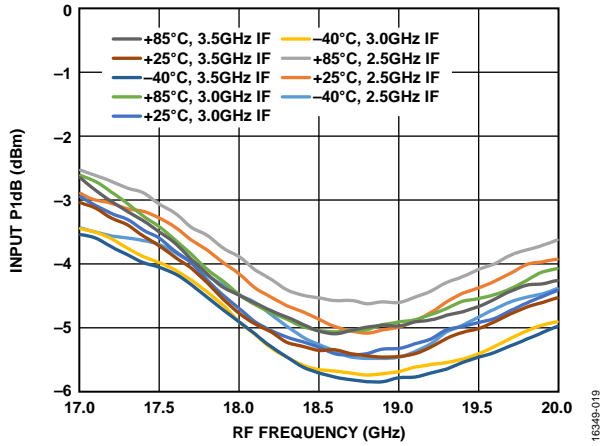

Figure 19. Input P1dB vs. RF Frequency at Various Temperatures and Various IF Frequencies

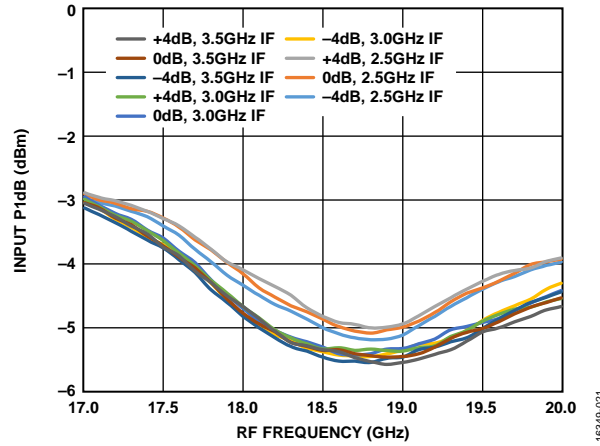

Figure 21. Input P1dB vs. RF Frequency at Various LO Powers and Various IF Frequencies

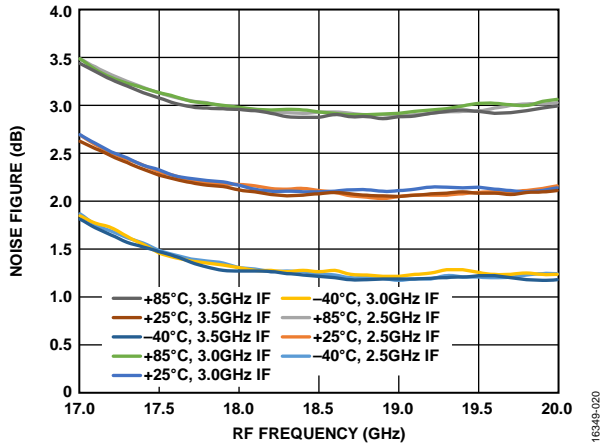

Figure 20. Noise Figure vs. RF Frequency at Various Temperatures and Various IF Frequencies

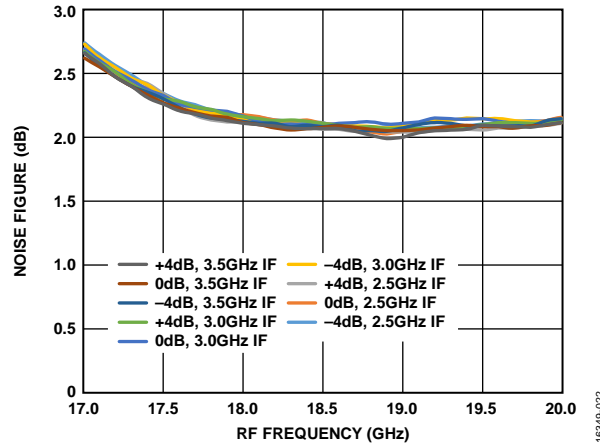

Figure 22. Noise Figure vs. RF Frequency at Various LO Powers and Various IF Frequencies

IF BANDWIDTH

Data taken at VDRF = 3 V, VDLO = 3 V, IDRf = 68 mA, LO = -4 dBm ≤ LO ≤ +4 dBm at 10 GHz, -40°C ≤ T_A ≤ +85°C, with Mini-Circuits QCN-45+, power splitter, unless otherwise noted.

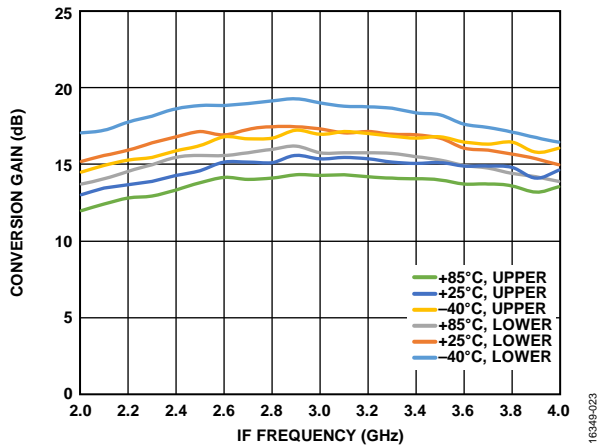

Figure 23. Conversion Gain vs. IF Frequency at Various Temperatures and Sidebands

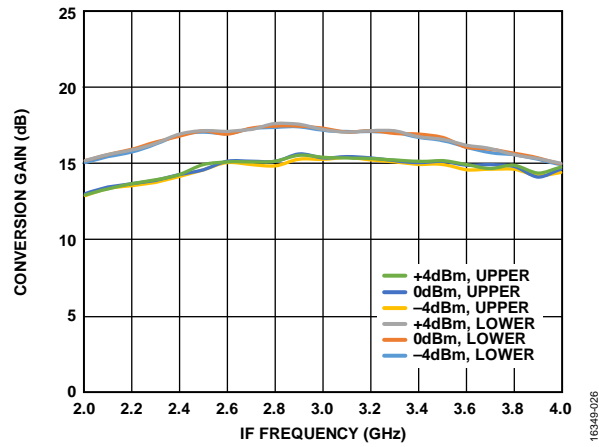

Figure 25. Conversion Gain vs. IF Frequency at Various LO Powers and Sidebands

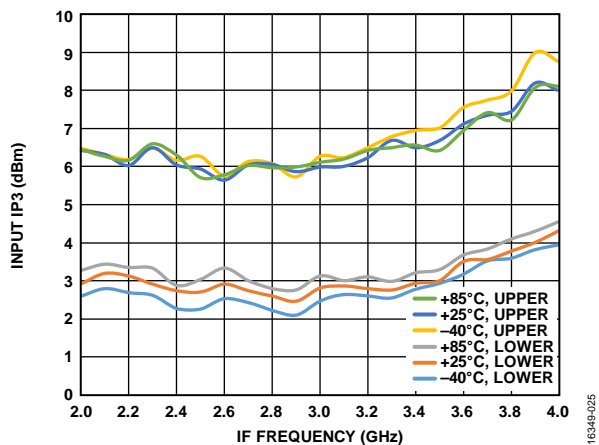

Figure 24. Input IP3 vs. IF Frequency at Various Temperatures and Sidebands

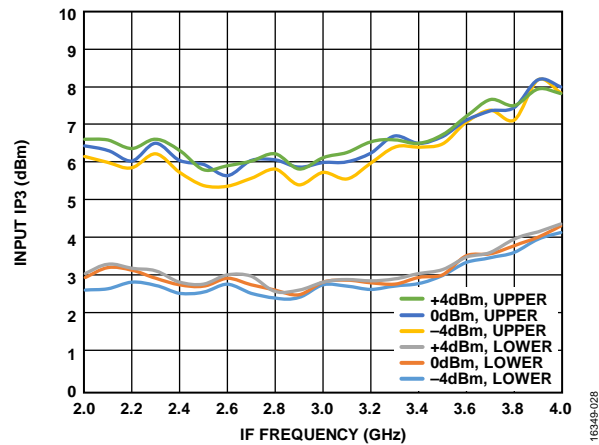

Figure 26. Input IP3 vs. IF Frequency at Various LO Powers and Sidebands

LEAKAGE PERFORMANCE

Data taken at VDRF = 3 V, VDLO = 3 V, LO = -4 dBm ≤ LO ≤ +4 dBm, -40°C ≤ T_A ≤ +85°C, with Mini-Circuits QCN-45+, power splitter, unless otherwise noted.

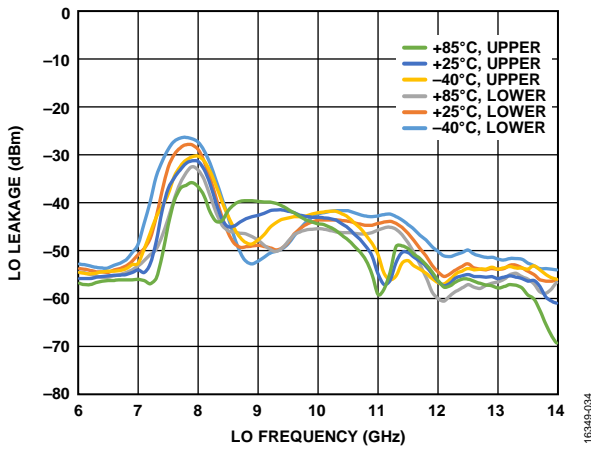

Figure 27. LO Leakage at IF Output vs. LO Frequency at Various Temperatures and Sidebands

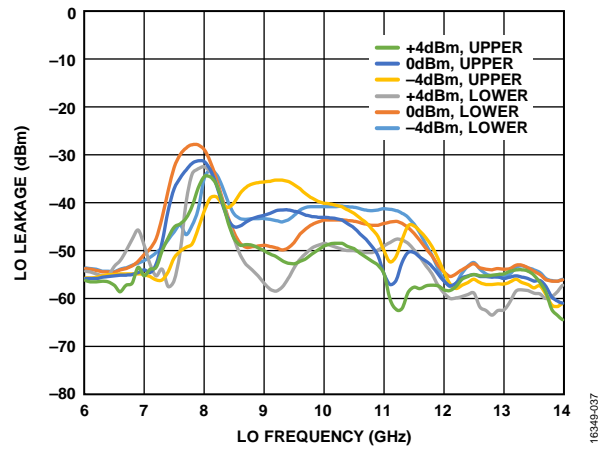

Figure 29. LO Leakage at IF Output vs. LO Frequency at Various LO Powers and Sidebands

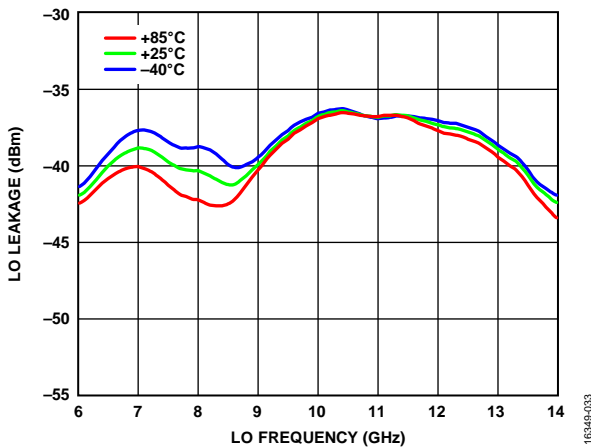

Figure 28. LO Leakage at RFIN vs. LO Frequency at Various Temperatures

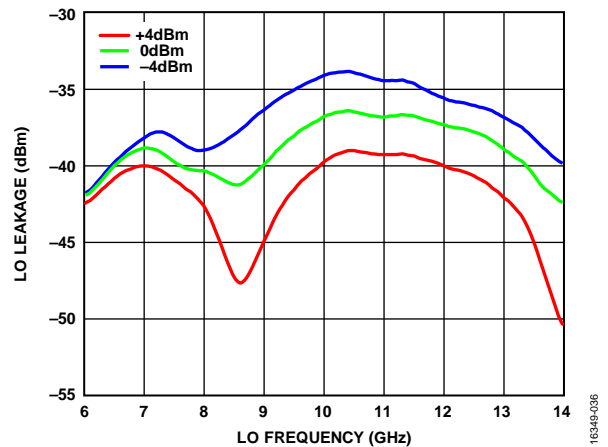

Figure 30. LO Leakage at RFIN vs. LO Frequency at Various LO Powers

RETURN LOSS PERFORMANCE

Data taken at VDRF = 3 V, VDLO = 3 V, IDRf = 68 mA, LO = -4 dBm ≤ LO ≤ +4 dBm, -40°C ≤ T_A ≤ +85°C, with Mini-Circuits QCN-45+, power splitter, unless otherwise noted. Measurement reference plane at connector.

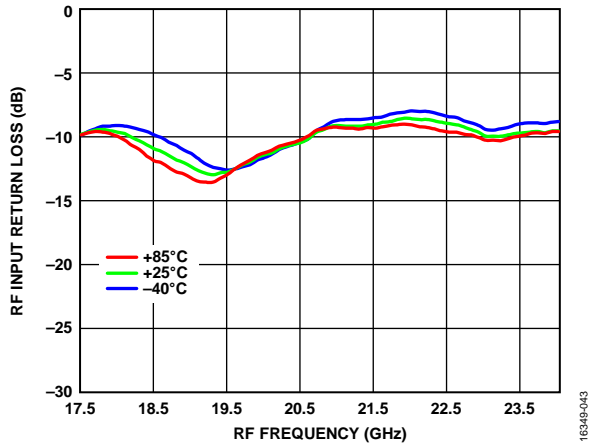

Figure 31. RF Input Return Loss vs. RF Frequency at Various Temperatures

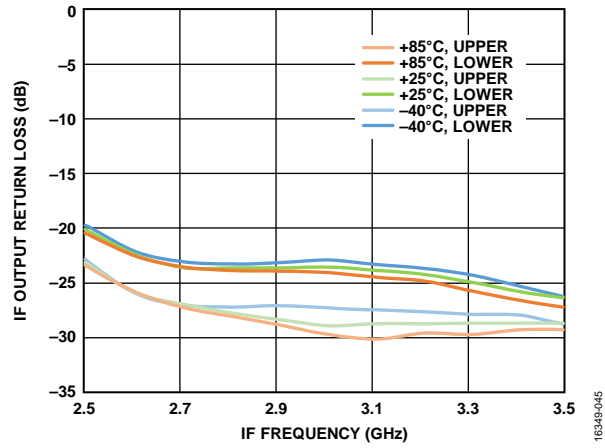

Figure 33. IF Output Return Loss vs. IF Frequency at Various Temperatures and Sidebands

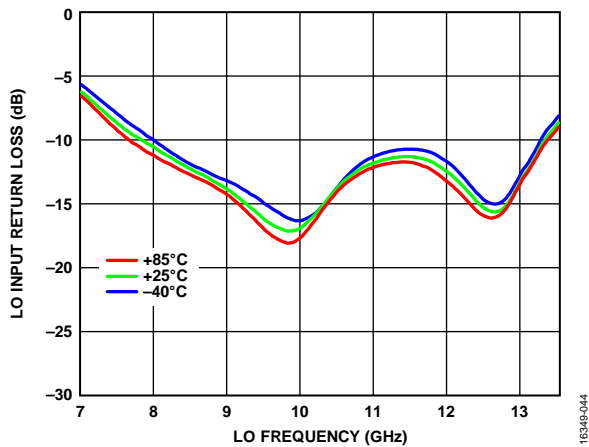

Figure 32. LO Input Return Loss vs. LO Frequency at Various Temperatures

SPURIOUS PERFORMANCE

Data taken at VDRF = 3 V, VDLO = 3 V, IDRF = 68 mA, LO = 0 dBm, and $-40^{\circ}\text{C} \leq T_A \leq +85^{\circ}\text{C}$ with a Mini-Circuits QCN-45+, power splitter, unless otherwise noted.

Table 5. LO Harmonic Leakage at IF Output

LO Frequency (MHz)	Frequency			
	1.0	2.0	3.0	4.0
7000	-48	-65	-42	-57
8500	-47	-64	-57	-64
9000	-50	-51	-51	-61
10,000	-49	-40	-52	-61
11,000	-49	-47	-61	N/A
12,000	-58	-46	-56	N/A
13,000	-54	-42	-59	N/A
13,500	-55	-40	N/A	N/A

M × N SPURIOUS PERFORMANCE FOR LO = 0 dBm

Mixer spurious products are measured in dBc from the IF output power level. Spurious values are measured using the following equation: (M × RF) + (N × LO). N/A means not applicable. The frequencies are referred from the frequencies applied to the pin of the ADMV1012.

Lower Sideband

IF = 2.8 GHz

RF = 18000 MHz at -20 dBm and LO = 10400 MHz at 4 dBm. All values in dBc below IF power level. N/A means not applicable.

M × RF		N × LO				
		0	1	2	3	4
M × RF	-2	N/A	N/A	N/A	N/A	-58.6
	-1	N/A	N/A	0	-68.5	-71.1
	0	N/A	-42	-38.4	-52.2	-53.2
	1	-49.1	-70.2	-65.7	-67.9	N/A
	2	-66.5	-74.4	N/A	N/A	N/A

IF = 3.3 GHz

RF = 18000 MHz at RF power of -20 dBm, and LO = 10650 MHz at LO power of 4 dBm. All values in dBc below IF power level. N/A means not applicable.

M × RF		N × LO				
		0	1	2	3	4
M × RF	-2	N/A	N/A	N/A	N/A	-56
	-1	N/A	N/A	0	-72.5	-83.9
	0	N/A	-42.3	-44.7	-54.1	-56.9
	1	-48.8	-68.3	-69.5	-63.4	N/A
	2	-71.7	-65.8	N/A	N/A	N/A

IF = 3.5 GHz

RF = 18000 MHz at RF power of -20 dBm, and LO = 10750 MHz at LO power of 4 dBm. All values in dBc below IF power level. N/A means not applicable.

M × RF		N × LO				
		0	1	2	3	4
M × RF	-2	N/A	N/A	N/A	N/A	-57.5
	-1	N/A	N/A	0	-76.6	-74.2
	0	N/A	-42.7	-33.4	-47.2	-46.2
	1	-48.2	-74.5	-83.8	N/A	N/A
	2	-77.2	-59.9	N/A	N/A	N/A

Upper Sideband

IF = 2.8 GHz

RF = 23000 MHz at RF power of -20 dBm, and LO = 10100 MHz at LO power of 4 dBm. All values in dBc below IF power level. N/A means not applicable.

M × RF		N × LO				
		0	1	2	3	4
M × RF	-2	N/A	N/A	N/A	N/A	-56.4
	-1	N/A	N/A	0	-62.6	-72.3
	0	N/A	-39.9	-40.2	-46.9	-47
	1	-53.2	-77.8	-64.9	N/A	N/A
	2	-60.9	N/A	N/A	N/A	N/A

IF = 3.3 GHz

RF = 23000 MHz at RF power of -20 dBm, and LO = 9850 MHz at LO power of 4 dBm. All values in dBc below IF power level. N/A means not applicable.

M × RF		N × LO				
		0	1	2	3	4
M × RF	-2	N/A	N/A	N/A	N/A	-61.5
	-1	N/A	N/A	0	-53.8	-69
	0	N/A	-40.6	-42	-44.2	-56.5
	1	-52.9	-99.8	-65.3	N/A	N/A
	2	-74.9	N/A	N/A	N/A	N/A

IF = 3.5 GHz

RF = 23000 MHz at RF power of -20 dBm, and LO = 9750 MHz at LO power of 4 dBm. All values in dBc below IF power level. N/A means not applicable.

M × RF		N × LO				
		0	1	2	3	4
M × RF	-2	N/A	N/A	N/A	N/A	-67.6
	-1	N/A	N/A	0	-50.1	-63.9
	0	N/A	-41.5	-40.8	-47.4	-64.8
	1	-53.6	-68.7	-72.2	N/A	N/A
	2	-70.7	N/A	N/A	N/A	N/A

THEORY OF OPERATION

The ADMV1012 is a compact GaAs, MMIC, double sideband (DSB) downconverter in a RoHS compliant package optimized for both upper sideband and lower sideband point to point microwave radio applications operating in the 17.5 GHz to 24 GHz input frequency range. The ADMV1012 supports LO input frequencies of 7 GHz to 13.5 GHz and IF output frequencies of 2.5 GHz to 3.5 GHz.

The ADMV1012 uses a RF LNA followed by an I/Q double balanced mixer, where a driver amplifier drives the LO (see Figure 1). This combination of design, process, and packaging technology allows the functions of these subsystems to be integrated into a single die, using mature packaging and interconnection technologies to provide a high performance, low cost design with excellent electrical, mechanical, and thermal properties. In addition, the need for external components is minimized, optimizing cost and size.

LO DRIVER AMPLIFIER

The LO driver amplifier takes a single LO input and doubles the frequency and amplifies it to the desired LO signal level for the mixer to operate optimally. The LO driver amplifier is self biased, and it requires only a single dc bias voltage (VDLO), which draws approximately 170 mA at 3 V under the LO drive. The LO amplitude range of -4 dBm to $+4$ dBm makes it compatible with the Analog Devices, Inc., wideband synthesizer portfolio without the need for an external LO driver amplifier.

MIXER

The mixer is an I/Q double balanced mixer, and this mixer topology reduces the need for filtering unwanted sideband. An external 90° hybrid is required to select the upper sideband of operation. The ADMV1012 has been optimized to work with the Mini-Circuits QCN-45+ RF 90° hybrid.

LNA

The LNA requires a single dc bias voltage (VDRF) and a single dc gate bias (VGRF) to operate. Starting at -1.8 V at the gate supply (VGRF), the LNA is biased at $+3$ V (VDRF). Then, the gate bias (VGRF) is varied until the desired LNA bias current (IDRF) is achieved. The desired LNA bias current is 68 mA at 3 V under small signal conditions.

The typical application circuit (see Figure 34) shows the necessary external components on the bias lines to eliminate any undesired stability problems for the RF amplifier and the LO amplifier.

The ADMV1012 is a much smaller alternative to hybrid style image reject converter assemblies, and it eliminates the need for wire bonding by allowing the use of surface-mount manufacturing assemblies.

The ADMV1012 downconverter comes in a compact, thermally enhanced, 4.9 mm \times 4.9 mm, 32-terminal ceramic leadless chip carrier (LCC) package. The ADMV1012 operates over the -40°C to $+85^\circ\text{C}$ temperature range.

APPLICATIONS INFORMATION

The evaluation board and typical application circuit are optimized for low-side LO (upper sideband) performance with the Mini-Circuit QCN-45+ RF 90° hybrid. Because the I/Q mixers are double balanced, the ADMV1012 can support IF frequencies from 3.5 GHz to low frequency.

TYPICAL APPLICATION CIRCUIT

The typical applications circuit is shown in Figure 34. The application circuit shown has been replicated for the evaluation board circuit.

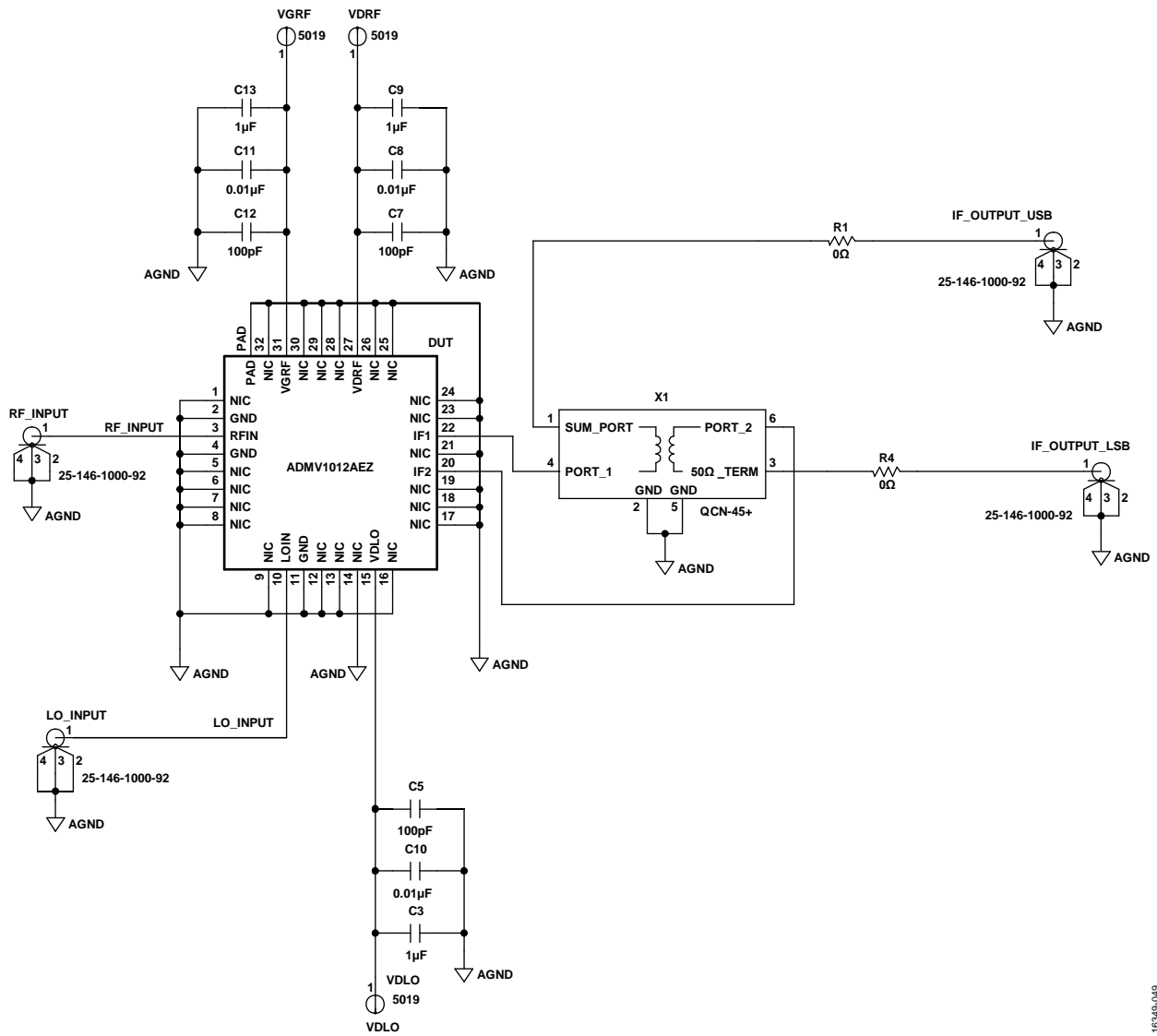

Figure 34. Typical Application Circuit

16349-049

EVALUATION BOARD INFORMATION

The circuit board used in the application must use RF circuit design techniques. Signal lines must have $50\ \Omega$ impedance, and the package ground leads and exposed pad must be connected directly to the ground plane similarly to that shown in Figure 35 and Figure 36. Use a sufficient number of via holes to connect the top and bottom ground planes. The evaluation circuit board shown in Figure 34 is available from Analog Devices upon request.

Layout

Solder the exposed pad on the underside of the ADMV1012 to a low thermal and electrical impedance ground plane. This pad is typically soldered to an exposed opening in the solder mask on the evaluation board. Connect these ground vias to all other ground layers on the evaluation board to maximize heat dissipation from the device package. Figure 35 shows the PCB land pattern footprint for the ADMV1012-EVALZ, and Figure 36 shows the solder paste stencil for the ADMV1012-EVALZ evaluation board.

Power-On Sequence

To set up the ADMV1012-EVALZ, take the following steps:

1. Power up the VGRF with a $-1.8\ \text{V}$ supply.
2. Power up the VDRF with a $3\ \text{V}$ supply.
3. Power up the VDLO with a $3\ \text{V}$ supply.
4. Adjust the VGRF supply between $-1.8\ \text{V}$ to $-0.4\ \text{V}$ until $\text{IDRF} = 68\ \text{mA}$.
5. Connect LOIN to the LO signal generator with an LO power of between $-4\ \text{dBm}$ to $+4\ \text{dBm}$.
6. For the upper sideband, add a $50\ \Omega$ termination to the IF_OUTPUT_LSB connector. For the lower sideband, add a $50\ \Omega$ termination to the IF_OUTPUT_USB connector.
7. Apply a RF signal to the RF_INPUT and LO_INPUT ports.

Power-Off Sequence

To turn off the ADMV1012-EVALZ, take the following steps:

1. Turn off the LO and RF signals.
2. Set VGRF to $-1.8\ \text{V}$.
3. Set the VDRF supply to $0\ \text{V}$ and then turn off the VDRF supply.
4. Set the VDLO supply to $0\ \text{V}$ and then turn off the VDLO supply.
5. Turn off the VGRF supply.

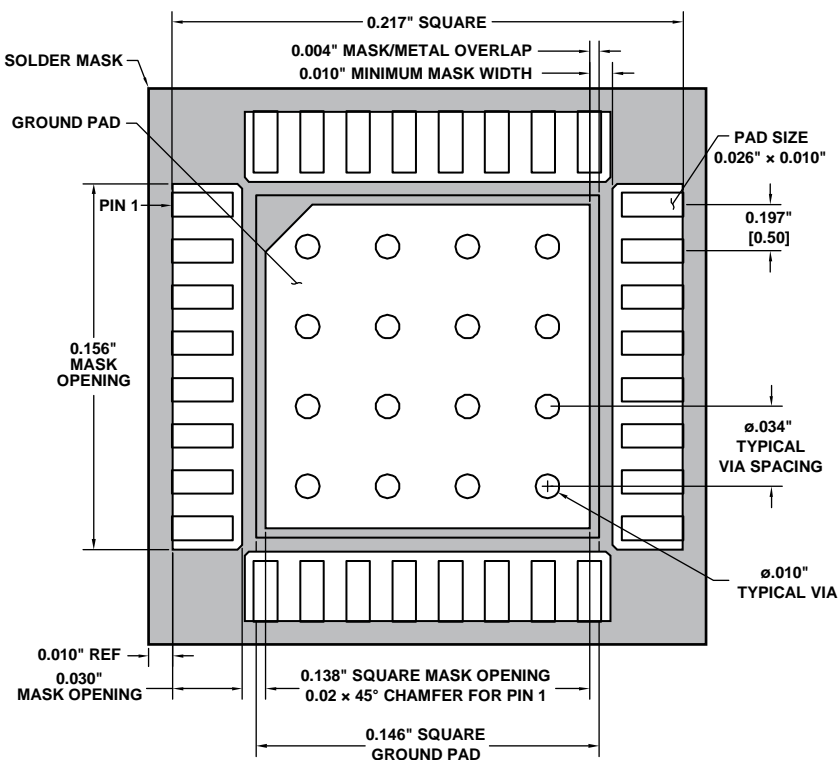

Figure 35. PCB Land Pattern Footprint of the ADMV1012-EVALZ

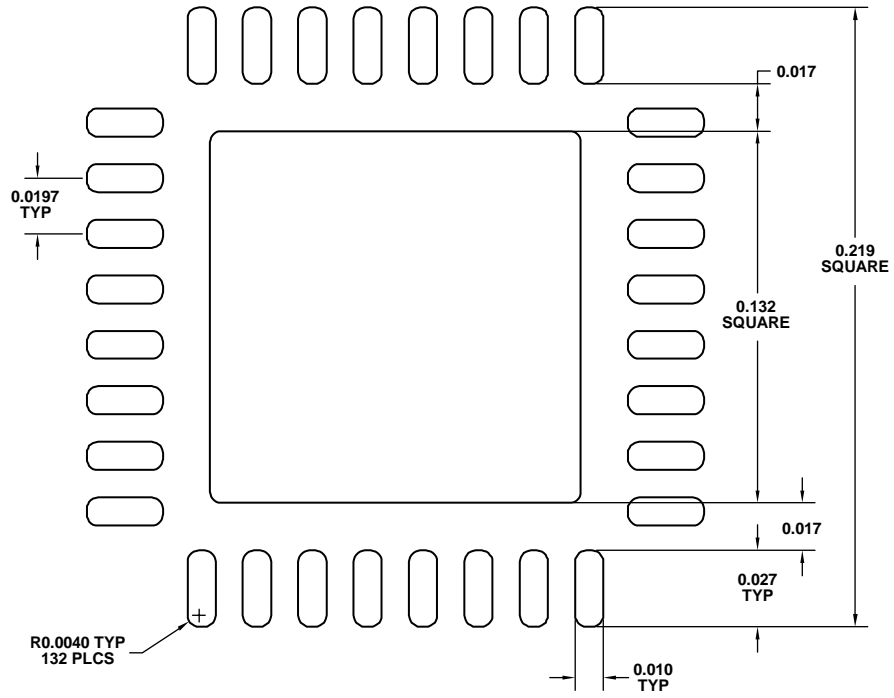
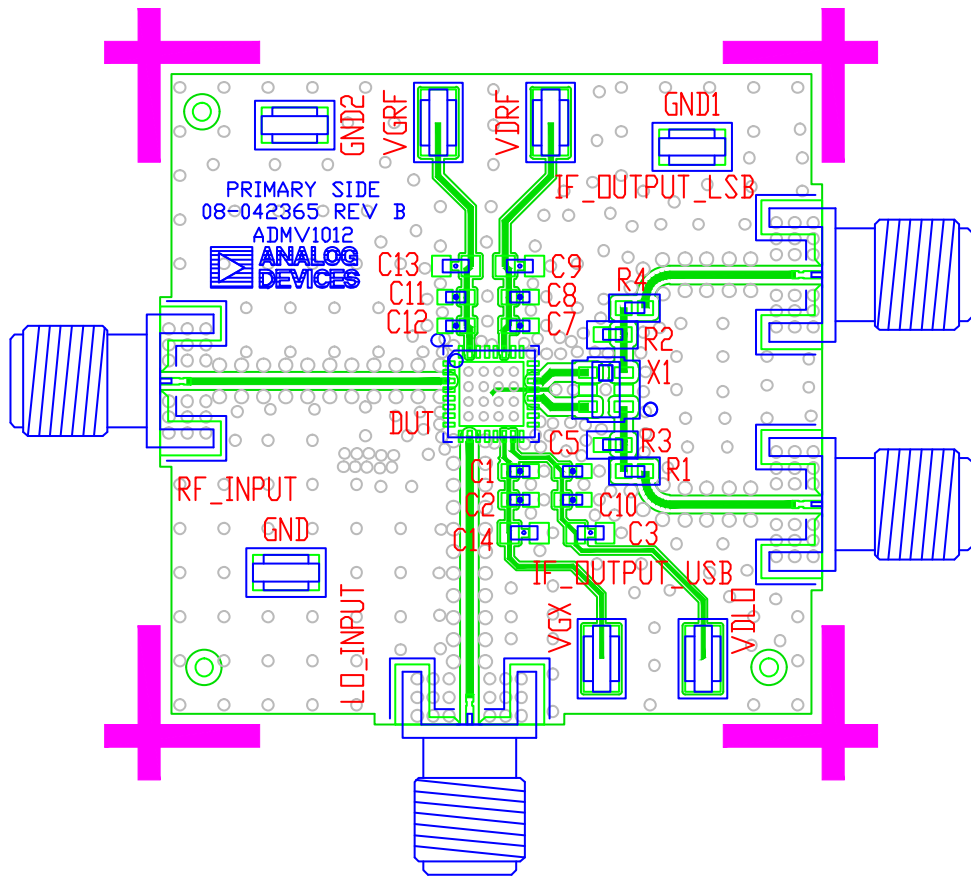

Figure 36. Solder Paste Stencil of the ADMV1012-EVALZ

18349-051



- NOTES
 1. NOT ALL COMPONENTS OR BIAS LINES ARE USED ON THE EVALUATION BOARD.

Figure 37. ADMV1012-EVALZ Evaluation Board Top Layer

18349-052

BILL OF MATERIALS

Table 6.

Qty.	Component	Description	Manufacturer/Part No.
1	Evaluation board	PCB	Analog Devices, Supplied/042365
4	C5, C7, C12	100 pF, high temperature, multilayer ceramic capacitors, NP0, 0402	TDK/C1005NP01H101J050BA
4	C8, C10, C11	0.01 μ F ceramic capacitors, X7R, 0402	Murata Manufacturing/GRM155R71E103KA01D
4	C3, C9, C13	1 μ F ceramic capacitors, X5R, 0603	Murata Manufacturing/GRM188R61E105KA12D
7	GND, VDLO, VDRF, VGRF	CONN-PCB test points, compact mini, CNKEY5019	Keystone Electronics Corporation/5019.00
4	LO_INPUT, RF_INPUT, IF_OUTPUT_LSB, IF_OUTPUT_USB	CONN-PCB, SMA K_SRI-NS, CNSMAL460W295H156	SRI CONNECTOR GAGE/25-146-1000-92
2	R1, R4	0 Ω resistor chips, SMD, JMPR, 0402	Panasonic/ERJ-2GE0R00X
1	X1	XFMR, power splitter/combiner, 2500 MHz to 4500 MHz, TSML126W63H42	Mini-Circuits/QCN-45+
1	Device under test (DUT)	17.5 GHz to 24 GHz, GaAs, MMIC, I/Q downconverter	Analog Devices Supplied/ADMV1012AEZ
1	Heatsink	Heatsink	Analog Devices Supplied/104365