



EVK-R8

LENA-R8 series modules evaluation kit

User guide



Abstract

This guide explains how to set up the EVK-R8 evaluation kits to evaluate u-blox LENA-R8 series modules supporting LTE Cat 1 bis / 2G cellular radio access technologies, plus concurrent reception of up to 4 GNSS systems with the integrated u-blox UBX-M10 GNSS receiver.

Document information

Title	EVK-R8	
Subtitle	LENA-R8 series modules evaluation kit	
Document type	User guide	
Document number	UBX-22018774	
Revision and date	R03	28-Sep-2023
Disclosure restriction	C1-Public	

This document applies to the following products:

Product name	Type number
EVK-R8001	EVK-R8001-00C-00
EVK-R8001M10	EVK-R8001M10-00C-00

u-blox or third parties may hold intellectual property rights in the products, names, logos and designs included in this document. Copying, reproduction, modification or disclosure to third parties of this document or any part thereof is only permitted with the express written permission of u-blox.

The information contained herein is provided "as is" and u-blox assumes no liability for its use. No warranty, either express or implied, is given, including but not limited to, with respect to the accuracy, correctness, reliability and fitness for a particular purpose of the information. This document may be revised by u-blox at any time without notice. For the most recent documents, visit www.u-blox.com.

Copyright © u-blox AG.

Contents

Document information	2
Contents	3
1 Introduction	4
2 Board quick start	5
2.1 Software installation	5
2.2 Board setup	5
2.2.1 SIM and antenna.....	5
2.2.2 Power supply.....	6
2.2.3 Local connectivity.....	7
2.3 Switch off the cellular system.....	9
3 Register to network	10
3.1 Enabling error result codes	10
3.2 PIN code insertion (when required).....	10
3.3 Registration on a cellular network.....	10
4 Setting up cellular packet data connection on Windows	11
4.1 How to install and configure a low data rate modem connection	11
4.2 How to install and configure a high data rate modem connection	13
5 EVK-R8 HW	15
5.1 EVK-R8 block diagram and basic description	15
5.2 Switches, jumpers and buttons	17
5.3 LEDs.....	18
5.4 Connectors	19
5.5 EVK-R8 pin out	20
5.6 Current consumption measurement	22
Appendix	23
A Setting up AT terminal application	23
B Glossary	25
C Declaration of conformities	25
Related documentation	26
Revision history	26
Contact	26

1 Introduction

The EVK-R8 kit is a powerful and easy-to-use tool that simplifies the evaluation of u-blox LENA-R8 series multimode modules. The following evaluation kits are available with u-blox LENA-R8 modules:

- The EVK-R8001 evaluation kit, for evaluation of LENA-R8001 modules, which integrate a cellular modem supporting LTE Cat 1bis and 2G radio access technologies
- The EVK-R8001M10 evaluation kit, for evaluation of LENA-R8001M10 modules, which integrate the same cellular modem of LENA-R8001 modules plus a GNSS receiver based on the u-blox M10 chipset. The two subsystems, cellular and GNSS, can operate fully independently.

All evaluation kits are herein referred as EVK-R8. As shown in [Figure 1](#), the EVK-R8 is formed of three boards:

- The motherboard, called EVB-WL3 or EVB, which contains the power supply and other peripherals for the cellular and GNSS module.
- The LENA-R8 adapter board, called ADP-R8, which contains the LENA-R8 module, (LENA-R8001 or LENA-R8001M10), and other connectors and switches.
- The GNSS adapter board, called ADP-GNSS, which contains the u-blox MAX-M10S GNSS module, the GNSS antenna connector and the USB connector for the GNSS module.

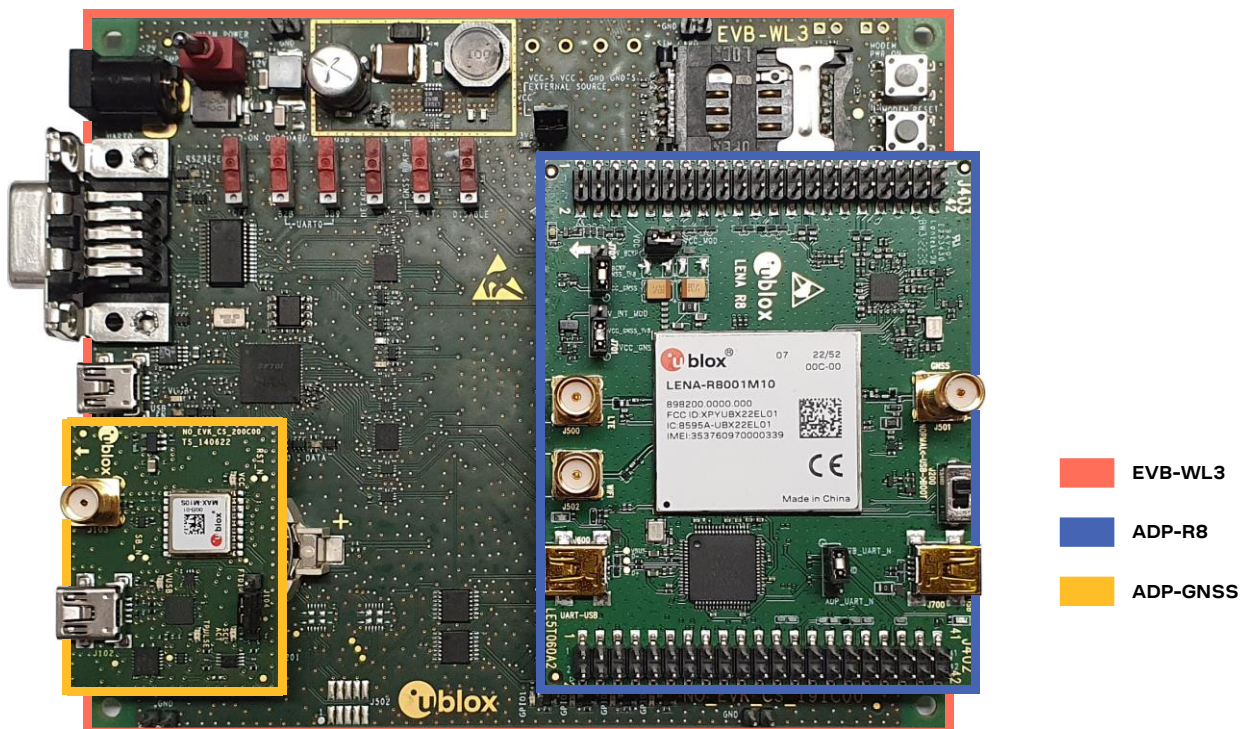

Figure 1: EVK-R8 evaluation kit formed by three boards

For more hardware details about the EVK-R8 evaluation kit, see [section 5](#)

2 Board quick start

2.1 Software installation

Before setting up the board, download and install the LENA-R8 USB drivers for Windows from <http://www.u-blox.com>.

2.2 Board setup

2.2.1 SIM and antenna

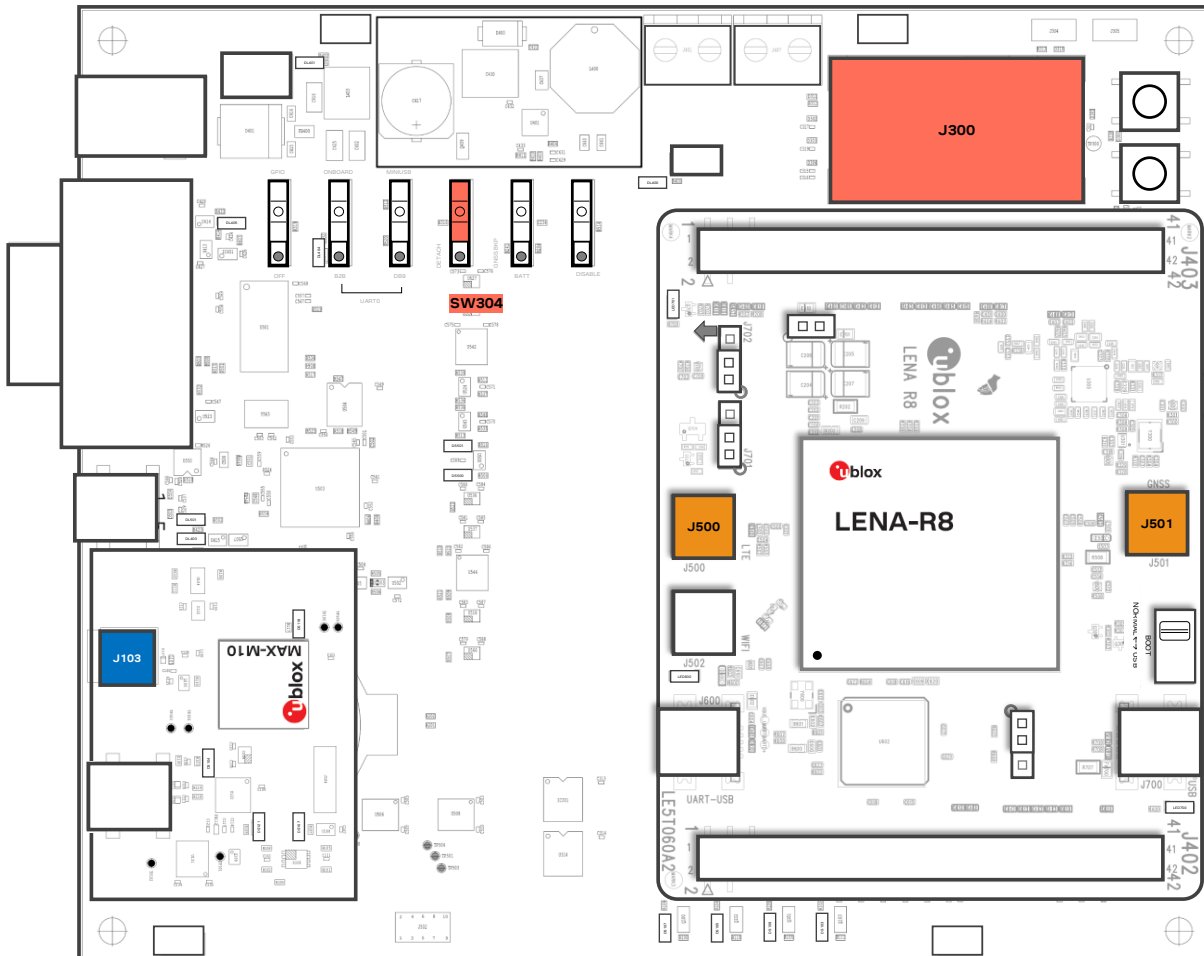

Figure 2: SIM and antenna set up

1. Insert a SIM card into **J300**, the SIM card holder.
2. Connect the cellular antenna provided with the EVK-R8 evaluation kit box to **J500**, the cellular antenna SMA connector.
3. For LENA-R8001M10, connect the GNSS antenna provided with the EVK-R8 evaluation kit box to **J501**, the GNSS antenna SMA connector.
4. For LENA-R8001, if MAX-M10S GNSS module function required, connect the GNSS antenna provided with the evaluation kit to **J103**, the GNSS antenna SMA connector. Keep the cellular GNSS detach switch **SW304** in “GNSS” position.
5. Place the GNSS antenna in a location with a good view of the sky.

2.2.2 Power supply

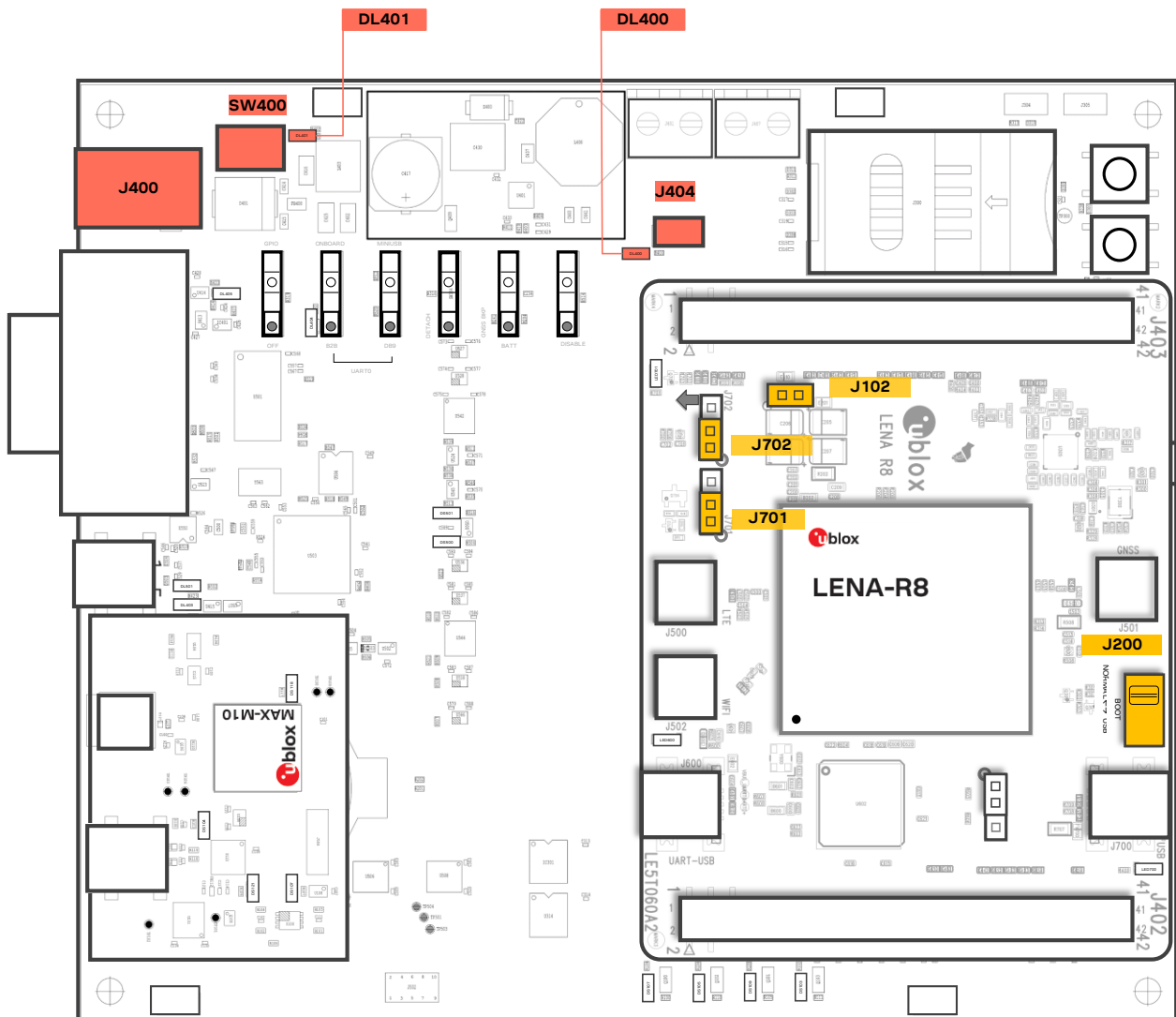

Figure 3: Power supply set up

1. Connect the AC / DC +12 V power supply adapter to **J400**, the 9 – 18 V Power Input connector. LED **DL401** lights turn blue.
2. Provide a jumper socket on **J404**, the Cellular VCC supply jumper, and to **J102**, the Cellular VCC supply jumper.
3. For LENA-R8001M10, provide a jumper socket on **J701**, the VCC_GNSS enable jumper, and to **J702**, the VBCKP_GNSS enable jumper.
4. Set **J200**, the Cellular USB boot slide switch on the “NORMAL” position. For FW update over USB, set the slide switch on the “USB” position.
5. Turn **SW400**, the Main power switch to the ON position. LED **DL400** lights turn green. The cellular system of the LENA-R8 module is powered but still switched off. The GNSS system of the LENA-R8001M10 module switches on.

2.2.3 Local connectivity



Figure 4: Set up local connectivity via USB or UART

2.2.3.1 Communication via USB

1. For communication via the cellular USB interface, connect a USB cable to **J700**, the Cellular native **USB** connector. **LED700** turns blue.
2. Press **SW302**, the cellular power-on button, to switch on the cellular system of LENA-R8 module.
3. Once the cellular system switched on, the COM ports in the [Table 1](#) are enabled by the Windows USB driver after the module boot (see Windows device manager for numbering of ports)¹:

Parameter	Type	Remarks
Unisoc Usb Serial Port 0	Ports (COM & LPT)	AT command interface and data communication
Unisoc Usb Serial Port 1	Ports (COM & LPT)	Reserved
Unisoc Usb Serial Port 2	Ports (COM & LPT)	Reserved
Unisoc Usb Serial Port 3	Ports (COM & LPT)	Diagnostic log (CP)
Unisoc Usb Serial Port 4	Ports (COM & LPT)	Diagnostic log (AP)
Unisoc Usb Serial Port 5	Ports (COM & LPT)	GNSS data tunneling
Unisoc Usb Serial Port 6	Ports (COM & LPT)	AT command interface and data communication
Unisoc Usb Serial Port 7	Ports (COM & LPT)	AT command interface and data communication

Table 1: Cellular USB interface configuration

¹ A message “driver installation fail” may appear on Windows if the USB cable has been connected before the end of the module boot, but this can be ignored as the normal operating functionality will be available anyway after the end of the module boot.

Run an AT terminal (e.g., the u-blox m-center tool), select the AT port with below settings:

Data rate	Data bits	Parity	Stop bits	Flow control
115200 bit/s	8	N	1	HW

See [appendix A](#) for how to configure the u-blox m-center AT terminal for Windows.

2.2.3.2 Communication via UART

1. For communication via the UART interfaces, use one of the following connections:
 - a. Connect a USB cable to **J501** (mini-USB), the Cellular USB Main UART. The LED **DL501** turns blue. When a USB cable is connected to this mini-USB connector, two COM ports are enabled in Windows.
 - The main 8-wire UART interface of the cellular system integrated in LENA-R8 modules is available over the first COM port opened by the driver after the end of the cellular system boot, once the cellular system is switched on.
 - The 2-wire UART interface of the GNSS system integrated in LENA-R8001M10 modules is available over the second COM port opened by the driver after the end of the GNSS system boot.
 - b. Connect an RS232 cable to the **J500**, the Cellular RS232 Main UART, a DB9 connector: the main 8-wire UART interface of the cellular system is available over RS232 after the cellular system boot, once the cellular system is switched on.
 - c. Connect a USB cable to **J600** (mini-USB), the Cellular USB two UARTs². The **LED600** turns green. The two 4-wire UART interfaces² of the cellular system are each available over the two numbered COM ports opened by the driver, after the end of the cellular system boot once the cellular system is switched on.

Type of connections	SW401	SW403	J601	LED
Access to the main UART interface over the Cellular USB (Main UART) mini-USB connector on EVB-WL3 (J501)	ON BOARD	MINIUSB	Jumper socket on pins 1-2	DL403 DL501
Access to the LENA-R8001M10 GNSS UART interface over the Cellular USB mini-USB connector on EVB-WL3 (J501)	ON BOARD	MINIUSB	Jumper socket on pins 1-2	DL403 DL501
Access to the main UART interface over the Cellular RS232 (Main UART) DB9 connector on EVB-WL3 (J500)	ON BOARD	DB9	Jumper socket on pins 1-2	DL405
Access to the two UART interfaces ² over the Cellular USB (Two UARTs) mini-USB connector on ADP-R8 (J201)	B2B	Do not care	Jumper socket on pins 2-3	DL404 DS201
Access to UART(s) interface(s) ² over the DIL B2B header on the top of the adapter board (J402)	B2B	Do not care	No jumper socket	DL404

Table 2: UART serial interfaces configuration

Run an AT terminal (such as the u-blox m-center tool) selecting the AT port, with these settings:

Data rate	Data bits	Parity	Stop bits	Flow control
115200 bit/s	8	N	1	HW

See [appendix A](#) for how to configure the u-blox m-center AT terminal for Windows.

2. Press **SW302**, the cellular power-on button, to switch on the cellular system of LENA-R8 module.

² The support of the auxiliary UART interface is not presented with the “00C” product version of LENA-R8 modules

2.3 Switch off the cellular system

To switch off the cellular system in the EVK-R8, send the +CPWROFF AT command.

-  Issue AT+CPWROFF command before switching off the main power supply, otherwise settings and configuration parameters may not be saved in the non-volatile memory of the cellular module.

3 Register to network

3.1 Enabling error result codes

Command sent by DTE (user)	DCE response (module)	Description
AT+CMEE=2	OK	Enable the cellular module to report verbose error result codes.

3.2 PIN code insertion (when required)

Command sent by DTE (user)	DCE response (module)	Description
AT+CPIN="8180"	OK	Enter the PIN code, if needed (enter the PIN of the SIM card – 8180 is an example).
AT+CLCK="SC",0,"8180"	OK	Unlock the PIN at power-on (the last parameter is the PIN of the SIM card – 8180 is an example).
AT+CLCK="SC",1,"8180"	OK	Lock the PIN at power-on (the last parameter is the PIN of the SIM card – 8180 is an example).

3.3 Registration on a cellular network

Command sent by DTE (user)	DCE response (module)	Description
AT+CREG?	+CREG: 0,1 OK	Verify the CS network registration.
AT+CEREG?	+CEREG: 0,1,"5684","03761b14",7 OK	Verify the EPS network registration.
AT+COPS=0	OK	Register the module on the network. The cellular module automatically registers itself on the cellular network. This command is necessary only if the auto-registration failed (AT+CREG? returns 0,0).
AT+COPS?	+COPS: 0,0,"I TIM",7 OK	Read the operator name and radio access technology (RAT).

For the complete description and syntax of the AT commands supported by LENA-R8 series modules, see the AT commands manual [\[1\]](#).

4 Setting up cellular packet data connection on Windows

This section describes how to set up a packet data connection on Windows 10 using the operating system's TCP/IP stack and EVK-R8. This is also called a dial-up connection.

The following examples describe how to install and configure two types of modems on Windows:

1. Low data rate modem: via the UART interface of the cellular module connected to the Windows PC by the **Cellular USB** connector (J501 on EVB) or the **Cellular RS232** connector (J500 on EVB)
2. High data rate modem: via the native USB interface of the cellular module connected to the Windows PC by the **Cellular Native USB** connector (J700 on the ADP-R8)

4.1 How to install and configure a low data rate modem connection

This example describes how to install and configure a low data rate packet data connection on a PC with Windows 10 operating system. This uses the TCP/IP stack of the PC over the UART interface of the cellular module connected to the PC by the cellular USB connector (J501 on EVB) or the cellular RS232 connector (J500 on EVB).

1. From **Control Panel**, select **Phone and Modem > Modems > Add**.

This opens the Add Hardware Wizard.

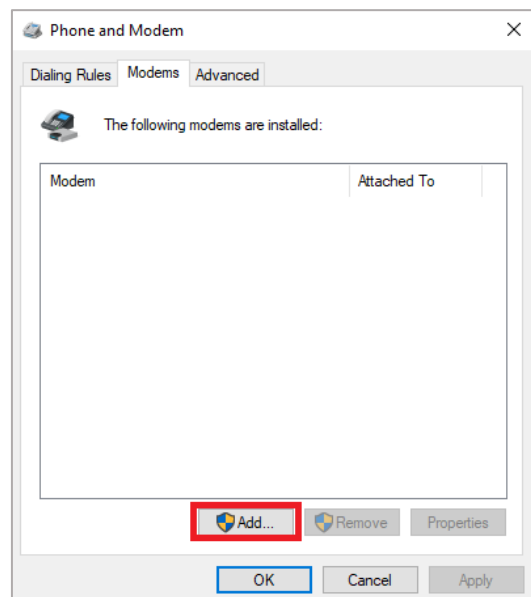
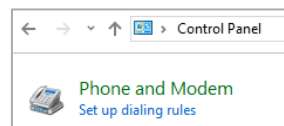

2. Tick “Don’t detect my modem” checkbox.
Click **Next**.

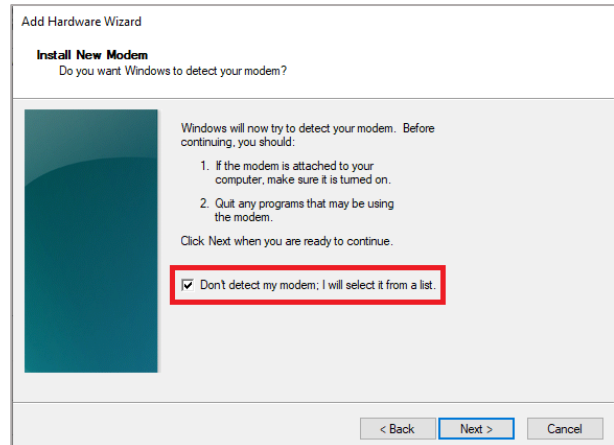

3. Select **Standard 33600 bps Modem**.
Click **Next**.

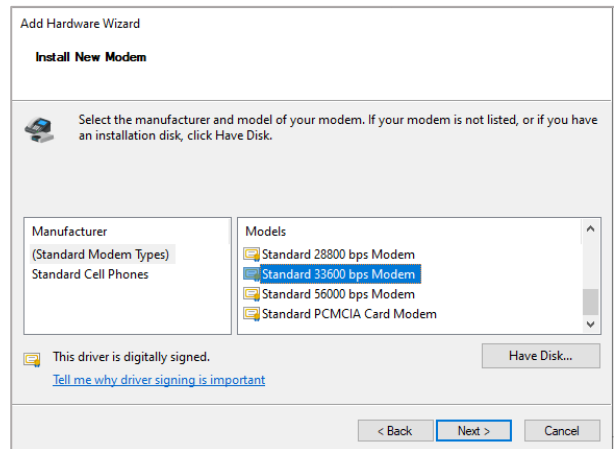

4. Select **COM** port for data communication and click **Next**. The modem will be installed on this COM port.
5. Click **Finish** to complete the installation.

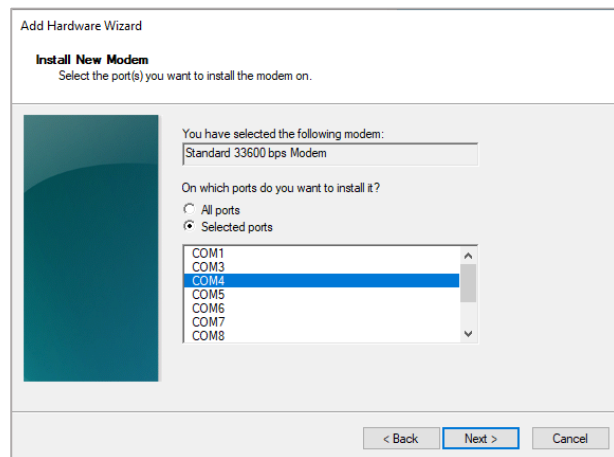

6. Now the new modem is visible in **Control Panel**, under **Phone and Modem > Modems**.

Any extra initialization AT command (e.g., to set a specific APN name) can be entered by:

Selecting **Properties** and filling in **Advanced > Extra initialization commands** text box.

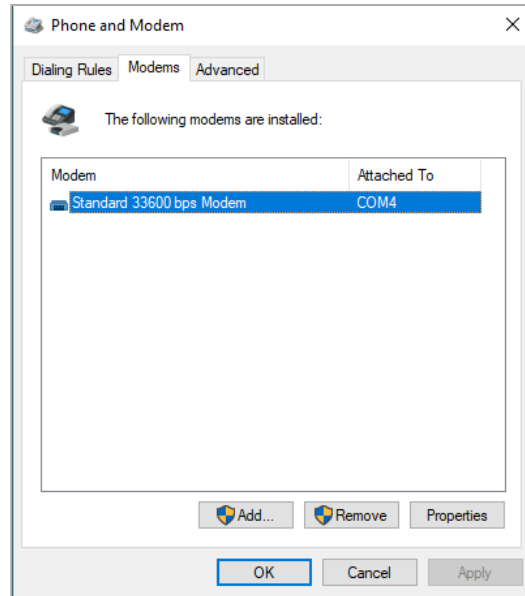

Now the module is ready, and the connection can be configured.

The modem configuration can also be edited in **Device Manager**, by clicking on the modem name.

4.2 How to install and configure a high data rate modem connection

This example describes how to install and configure a high data rate packet data connection on a PC with the Windows 10 operating system, using the TCP/IP stack of the PC, over the native USB interface of the cellular module connected to the Windows PC by the Cellular Native USB connector (J700 on the ADP-R8).

1. From **Control Panel**, select **Network and Sharing Center > Set up a new connection or network**.

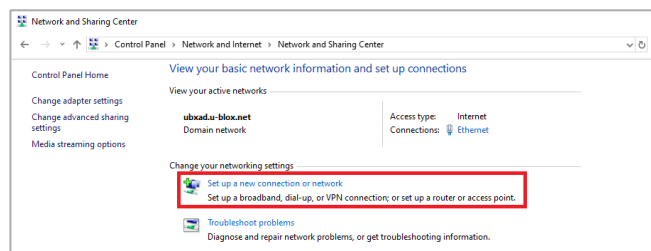

2. Click **Connect to the Internet** and then **Next**.

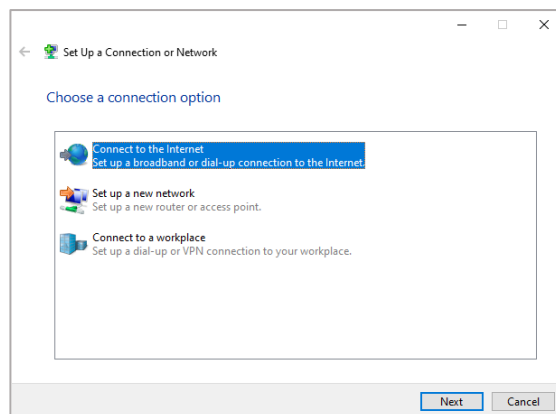

3. Select **Dial-up** and if requested, the modem previously installed.

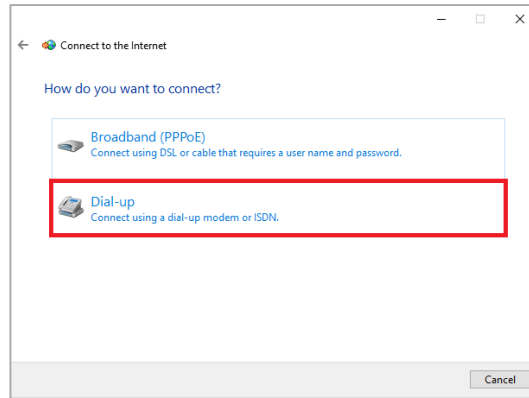

4. Select one of the two AT commands ports.

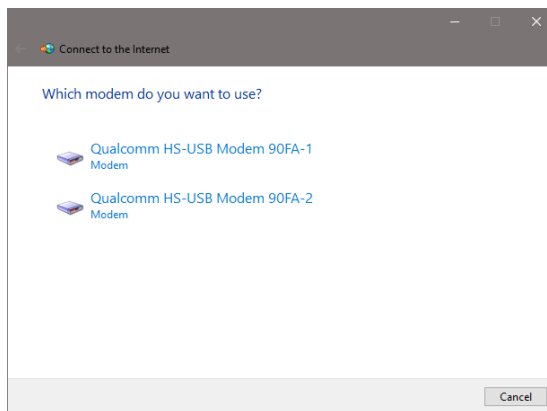

5. Enter the parameters for the dial-up connection:

- The module telephone number: ***99***1#** (Change if using a PDP context other than 1)
- The account info for the network operator
- A name for the connection (e.g., "R8 Dial-up")

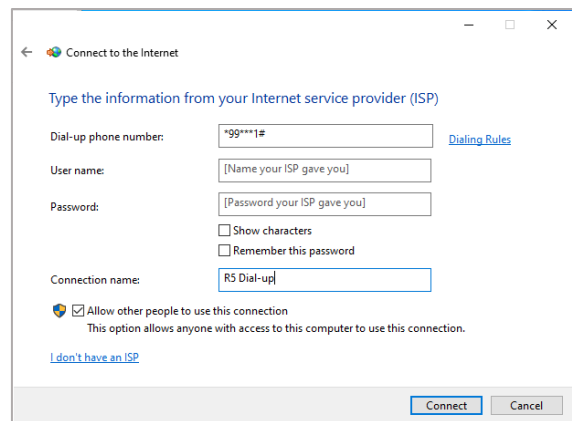

The packet data connection is now ready to be used with EVK-R8. Click **Connect** to start the connection, then start a browser to check internet connectivity.

Consult the cellular network operator for username and password. In most cases, they can be left empty.

5 EVK-R8 HW

5.1 EVK-R8 block diagram and basic description

Figure 5 shows the main interfaces and internal connections of the EVK-R8 evaluation kit:

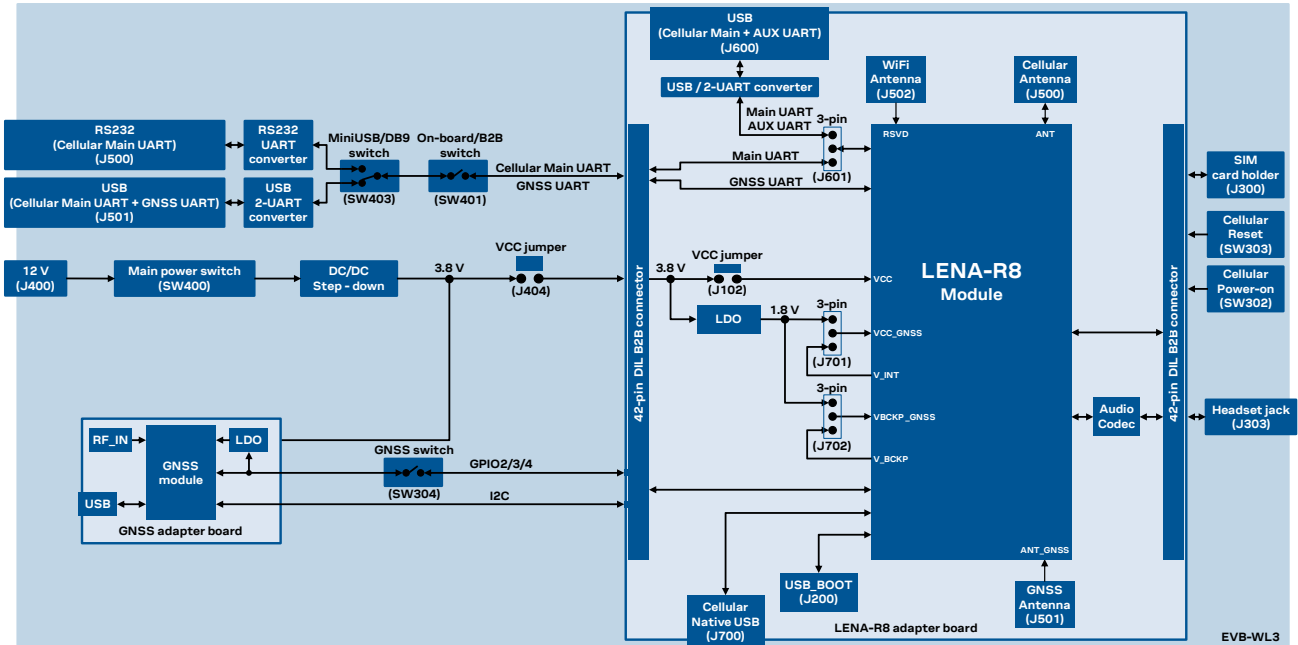

Figure 5: Block diagram of EVK-R8

The EVK-R8 is formed by three boards:

- The motherboard, called EVB-WL3 or EVB, contains the power supply and other peripherals for the cellular and GNSS module (such as SIM card holder, reset button and power-on button).
- The LENA-R8 adapter board, called ADP-R8, contains the LENA-R8 module.
- The GNSS adapter board, called ADP-GNSS, contains the u-blox GNSS module.

The LENA-R8 and the GNSS adapter boards (ADP-R8 and ADP-GNSS respectively) are connected by male header board-to-board connectors on the bottom of the adapter boards and their corresponding female connectors on top of the lower board (EVB-WL3).

The USB interface of the LENA-R8 cellular system is available on the native USB connector (J700) on the cellular adapter board (ADP-R8).

The main UART and the auxiliary UART² interfaces of the LENA-R8 cellular system can be routed as follows, by the 3-way UARTs' routing switch (J601) available on the LENA-R8 adapter board (ADP-R8) as illustrated in Figure 6:

- EVB position (pin 1-2 of J601 shorted by jumper socket): main UART routed as 8-wire interface to the lower EVB-WL3 board by the dual-in-line male board-to-board connectors mounted on the bottom of the adapter board ADP-R8. According to the mini-USB / DB9 switch (SW403) setting on the EVB-WL3, the main 8-wire UART interface can be accessed on the USB connector (J501) or on the RS232 DB9 connector (J500) on the EVB-WL3, with the on-board / B2B switch (SW401) on the EVB-WL3 set to "on-board". The auxiliary UART² interface is not available.
- ADP position (pin 2-3 of J601 shorted by jumper socket): main UART and auxiliary UART² routed as 4-wire interfaces to the USB two UARTs connector (J600) mounted on the adapter board, with the on-board / B2B switch (SW401) on the EVB-WL3 board is set to "B2B".
- No position (no jumper socket on J601): main 8-wire UART interface or main 4-wire UART with auxiliary 4-wire UART² interfaces, routed to the dual-in-line male header connectors mounted on

the top of the adapter board ADP-R8, allowing a connection to an external compatible device with the on-board / B2B switch (SW401) on the EVB-WL3 board set to “B2B”.

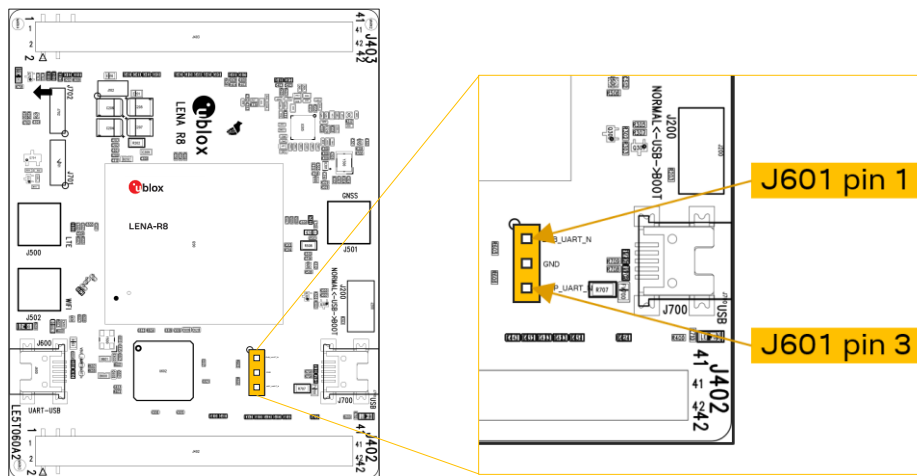

Figure 6: 3-pin header J601 available to set the routing of the UART interfaces

The main GNSS supply input (VCC_GNSS) of the GNSS system integrated in the LENA-R8001M10 modules can be fed using the main supply available on the ADP-R8 adapter board or using the V_INT supply output of the cellular system integrated in LENA-R8001M10 modules by properly changing the position of the jumper socket on the 3-pin header J701:

- VCC position (pin 1-2 of J701 shorted by jumper socket): VCC_GNSS of LENA-R8001M10 fed by the main supply available on the ADP-R8 adapter board. In this case the GNSS system integrated in LENA-R8001M10 will switch-on / switch-off according to the presence of the main supply, which can be controlled by the main power switch **SW400** on the EVB-WL3 motherboard.
- V_INT position (pin 1-2 of J701 shorted by jumper socket): VCC_GNSS supply of LENA-R8001M10 fed by the V_INT supply output of LENA-R8001M10 cellular system. In this case the GNSS system integrated in LENA-R8001M10 will switch-on / switch-off as controlled by the cellular system integrated in LENA-R8001M10, sending related AT+UGPS=1 / AT+UGPS=0 commands.

Similarly, the GNSS backup supply input (VBCKP_GNSS) of the LENA-R8001M10 modules can be fed using the main supply available on the ADP-R8 adapter board or using the V_BCKP supply output of the cellular system integrated in LENA-R8001M10 modules by properly changing the position of the jumper socket on the 3-pin header J702:

- VCC position (pin 1-2 of J702 shorted by jumper socket): VBCKP_GNSS of LENA-R8001M10 fed by the main supply available on the ADP-R8 adapter board.
- V_BCKP position (pin 1-2 of J702 shorted by jumper socket): VBCKP_GNSS of LENA-R8001M10 fed by the V_BCKP supply output of LENA-R8001M10 cellular system.

The other peripherals of the module are available on the dual-in-line male header connectors (J402 / J403) on the top layer of the cellular adapter board ADP-R8.

The lower board is compatible with other u-blox cellular adapter boards. It contains additional switches, jumpers, connectors, LEDs and parts that are partially described in this document, because they are intended for use only with other u-blox cellular modules. It is recommended to leave any additional connector unconnected, and to leave any additional switch in its default configuration.

5.2 Switches, jumpers and buttons

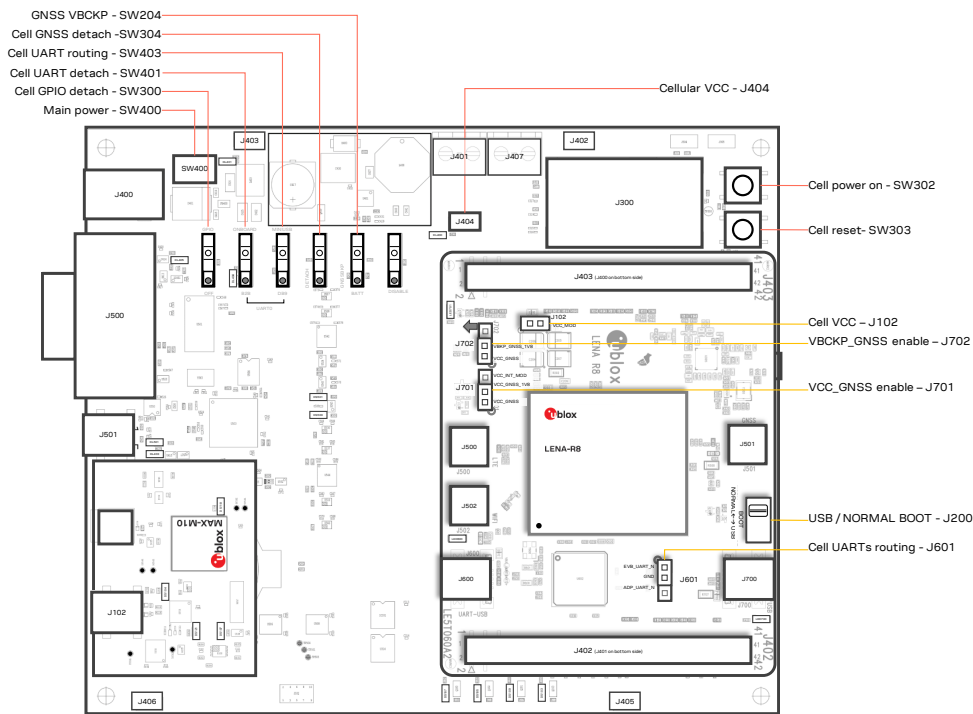

Function	Description	Name	Board
Main power switch	Power on / off the whole evaluation kit	SW400	EVB
Cellular VCC	Jumper socket to provide the 3.8 V supply to the cellular VCC input	J404	EVB
Cellular power-on	Push button to switch-on the cellular system of LENA-R8	SW302	EVB
Cellular reset	Push button to reset the cellular system of LENA-R8	SW303	EVB
Cellular UART detach	Slide switch to attach / detach cellular UART from USB / RS232 connectors: when detached, UART signals available only on DIL B2B connector on ADP board	SW401	EVB
Cellular UART routing	Slide switch to select cellular main UART routing on USB or on RS232 connector	SW403	EVB
Cellular GPIO detach	Slide switch to attach / detach the cellular GPIOs from peripherals: when detached, SW300 the signals are available only on the DIL B2B connector on ADP-R8 board	SW300	EVB
Cellular GNSS detach	Slide switch to attach / detach the cellular system of LENA-R8 to the GNSS module SW304 mounted on the ADP-GNSS: when detached, signals are available only on DIL B2B connector on ADP-R8 board	SW304	EVB
GNSS V_BCKP	Slide switch to connect / disconnect backup battery to V_BCKP pin of the GNSS module mounted on the ADP-GNSS	SW204	EVB
Cellular VCC	Jumper socket to provide the 3.8 V supply to the cellular VCC input	J102	ADP-R8
Cellular UARTs routing	Jumper to route cellular UART interfaces to the USB two UARTs connector on the ADP-R8 (both Main and Auxiliary ² UART) or to lower EVB-WL3 motherboard by means of Dual-In-Line male Board-to-Board connectors (only Main UART)	J601	ADP-R8
Cellular USB boot	Slide switch to select cellular system boot mode: normal operating boot mode or USB boot mode for FW update	J200	ADP-R8
VCC_GNSS enable	Jumper socket to enable 1.8 V supply to VCC_GNSS input of LENA-R8001M10	J701	ADP-R8
VBCKP_GNSS enable	Jumper socket to enable 1.8 V supply to VBCKP_GNSS input of LENA-R8001M10	J702	ADP-R8

Table 3: EVK-R8 switch and button descriptions

5.3 LEDs

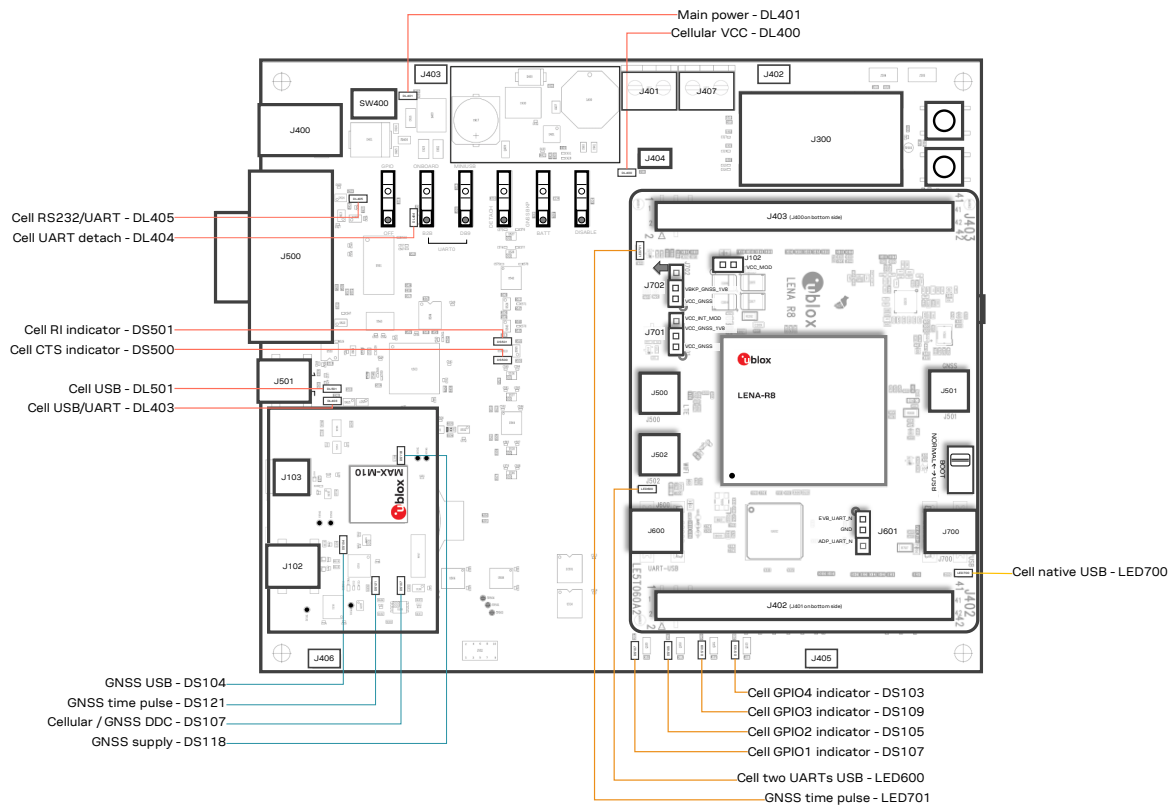

Function	Color	Description	LED #	Board
Main power	 	Power supply plugged in the 9 - 18 V Power Input	DL401	EVB
Cellular VCC	 	Cellular module supplied. Main power switch must be switched on	DL400	EVB
Cellular native USB	 	USB cable plugged in the Cellular native USB connector	LED700	ADP-R8
Cellular two UARTs ² USB	 	USB cable plugged in the Cellular two UARTs USB connector	LED600	ADP-R8
Cellular USB	 	USB cable plugged in the Cellular USB connector for UART access	DL501	EVB
Cellular USB / UART	 	Green light on when UART is routed to the cellular USB connector Red light blinks at UART TX or RX data on the Cellular USB connector	DL403	EVB
Cellular UART detach	 	UART signals are available only on the DIL connector on ADP-R8 board	DL404	EVB
Cellular RS232 / UART	 	Green light is activated when UART is routed to Cellular RS232 connector Red light blinks at UART TX or RX data on the Cellular RS232 connector	DL405	EVB
Cellular RI indicator	 	RI line turns ON (active low)	DS501	EVB
Cellular CTS indicator	 	CTS line turns ON (active low)	DS500	EVB
Cellular GPIO1 indicator	 	Green light on when cellular GPIO1 is high	DS107	EVB
Cellular GPIO2 indicator	 	Green light on when cellular GPIO2 is high	DS105	EVB
Cellular GPIO3 indicator	 	Green light on when cellular GPIO3 is high	DS109	EVB
Cellular GPIO4 indicator	 	Green light on when cellular GPIO4 is high	DS103	EVB
GNSS time pulse	 	Time pulse of the LENA-R8001M10 GNSS system	LED701	ADP-R8
GNSS supply	 	Supply of the GNSS module mounted on the ADP-GNSS is turned ON	DS118	ADP-GNSS
GNSS USB	 	USB cable plugged in GNSS USB connector	DS124	ADP-GNSS
GNSS time pulse	 	Time pulse of the GNSS module mounted on the ADP-GNSS	DS121	ADP-GNSS
Cellular / GNSS DDC	 	Cellular / GNSS module communication over the DDC (I2C) interface	DS132	ADP-GNSS

Table 4: EVK-R8 LED descriptions

5.4 Connectors

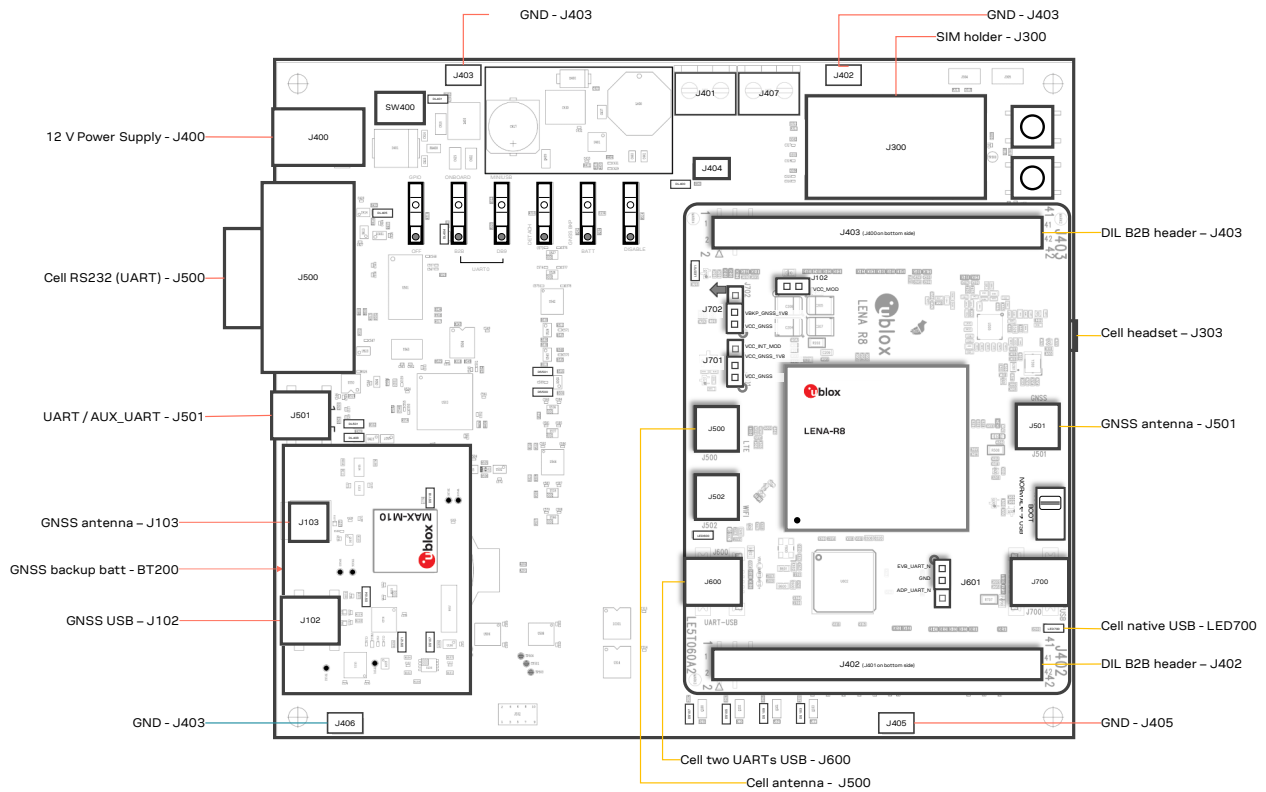



Function	Description	Name	Board
9 - 18 V Power Input	Connector for the AC / DC power adapter of the EVK AC: 100-240 V, 0,8 A, 50-60 Hz / DC: +12 V, 2,5 A 	J400	EVb
SIM card holder	SIM card holder	J300	EVb
Cellular antenna	SMA connector for the cellular antenna (ANT, Tx/Rx)	J500	ADP-R8
GNSS antenna	SMA connector for LENA-R8001M10 GNSS system (ANT_GNSS, Rx)	J501	ADP-R8
Cellular native USB	Mini USB connector for the cellular native USB interface	J700	ADP-R8
Cellular two UARTs ² USB	Mini USB connector for the cellular main and auxiliary ² USB interfaces	J600	ADP-R8
Cellular USB (UART)	Mini USB connector for the cellular UART interface converted as USB interface	J501	EVb
Cellular RS232 (UART)	DB9 connector for the cellular UART interface converted as RS232 interface	J500	EVb
DIL B2B headers	Dual-In-Line Board-to-Board connectors for LENA-R8 interfaces	J402-J403	ADP-R8
Cellular headset	Audio headset jack connector for the cellular audio interface	J303	EVb
GNSS antenna	SMA connector for the antenna of the GNSS module mounted on ADP-GNSS	J208	ADP-GNSS
GNSS USB	Mini USB connector for the GNSS module USB interface	J102	ADP-GNSS
GNSS backup battery	Backup battery socket for the GNSS module (under GNSS adapter board)	BT200	EVb
GND	Ground terminals for the probe reference	J402÷J406	EVb

Table 5: EVK-R8 connector descriptions

 **Caution!** In the unlikely event of a failure in the internal protection circuitry, there is a risk of an explosion when charging a fully or partially discharged battery. Replace the battery when it no longer has a sufficient charge for unit operation. Check the battery before use if the device has not been used for an extended period of time.

 **Caution!** Risk of explosion if battery is replaced with incorrect type. Dispose battery according to rules!

5.5 EVK-R8 pin out

Table 6 shows the Interfaces of LENA-R8 series modules, as routed on the 42-pin dual-in-line board-to-board connectors (J402, J403) on the adapter board ADP-R8 of the evaluation kit

LENA-R8 series		DIL B2B	LENA-R8 series		DIL B2B	LENA-R8 series		DIL B2B
Pin N°	Name	Name / Pin N°	Pin N°	Name	Name / Pin N°	Pin N°	Name	Name / Pin N°
1	GND	J402 pins 7-10	24	GPIO3	J402 pin 32	47	TXD_GNSS	J402 pin 20
2	V_BCKP	J402 pin 3	25	GPIO4	J402 pin 25	48	RXD_GNSS	J402 pin 19
3	GND	J402 pins 7-10	26	SDA ³	J403 pin 21	49	RSVD	Not present
4	V_INT	J402 pin 36	27	SCL ³	J403 pin 20	50	GND	J402 pins 7-10
5	GND	J402 pins 7-10	28	USB_D-	Not present	51	VCC	J403 pins 8-10
6	DSR	J402 pin 18	29	USB_D+	Not present	52	VCC	J403 pins 8-10
7	RI	J402 pin 17	30	GND	J402 pins 7-10	53	VCC	J403 pins 8-10
8	DCD	J402 pin 11	31	ANT_GNSS	Not present	54	GND	J402 pins 7-10
9	DTR	J402 pin 12	32	GND	J402 pins 7-10	55	GND	J402 pins 7-10
10	RTS	J402 pin 13	33	USB_BOOT	Not present	56	ANT	Not present
11	CTS	J402 pin 14	34	I2S_WA ⁴	J403 pin 25	57	GND	J402 pins 7-10
12	TXD	J402 pin 15	35	I2S_TXD4	J403 pin 24	58	GND	J402 pins 7-10
13	RXD	J402 pin 16	36	I2S_CLK ⁴	J403 pin 22	59	ANT_DET	Not present
14	GND	J402 pins 7-10	37	I2S_RX ⁴	J403 pin 23	60	GND	J402 pins 7-10
15	PWR_ON	J402 pin 29	38	SIM_CLK	J403 pin 15	61	GND	J402 pins 7-10
16	GPIO1	J402 pin 33	39	SIM_IO	J403 pin 14	62	RSVD	Not present
17	VUSB_DET	Not present	40	SIM_RST	J403 pin 16	63	GND	J402 pins 7-10
18	RESET_N	J403 pin 26	41	VSIM	J403 pin 13	64	GND	J402 pins 7-10
19	GPIO6	J402 pin 24	42	GPIO5	J402 pin 23	65-96	GND	J402 pins 7-10
20	GND	J402 pins 7-10	43	GND	J402 pins 7-10	97	RFCTRL1	J403 pin 5
21	RSVD	Not present	44	ANT_ON	J403 pin 3	98	RFCTRL2	J403 pin 6
22	GND	J402 pins 7-10	45	TIMEPULSE	J403 pin 2	99	VCC_GNSS	Not present
23	GPIO2	J402 pin 31	46	EXTINT	J403 pin 4	100	VBCKP_GNSS	Not present

Table 6: Interfaces of LENA-R8 series modules

Table 7 shows the pin-out of the 42-pin dual-in-line board-to-board connectors (J402, J403) on the adapter board ADP-R8.

³ The support of the cellular external I2C interface (SDA, SCL pins) is not presented with the “00C” product version of LENA-R8001M10 modules

⁴ The support of the I2S digital audio interface function (I2S_TXD, I2S_RXD, I2S_CLK, I2S_WA pins) is not presented with the “00C” product version of LENA-R8 modules

Dual-in-line board-to-board connector J402				Dual-in-line board-to-board connector J403			
Signal name	Pin N°	Pin N°	Signal name	Signal name	Pin N°	Pin N°	Signal name
GND	1	2	Not connected	GND	1	2	TIMEPULSE
V_BCKP	3	4	Not connected	ANT_ON	3	4	EXTINT
Not connected	5	6	Not connected	RFCTRL1	5	6	RFCTRL2
GND	7	8	GND	VCC	7	8	VCC
GND	9	10	GND	VCC	9	10	VCC
DCD	11	12	DTR	Not connected	11	12	Not connected
RTS	13	14	CTS	VSIM	13	14	SIM_IO
TXD	15	16	RXD	SIM_CLK	15	16	SIM_RST
RI	17	18	DSR	Not connected	17	18	Not connected
RXD_GNSS	19	20	TXD_GNSS	Not connected	19	20	SCL ⁴
Not connected	21	22	Not connected	SDA ⁴	21	22	I2S_CLK ⁴
GPIO5	23	24	GPIO6	I2S_RXD ⁴	23	24	I2S_TXD ⁴
GPIO4	25	26	Not connected	I2S_WA ⁴	25	26	RESET_N
Not connected	27	28	Not connected	MIC_GND	27	28	MIC_BIAS
PWR_ON	29	30	Not connected	Not connected	29	30	Not connected
GPIO2	31	32	GPIO3	Not connected	31	32	Not connected
GPIO1	33	34	Not connected	SPK_P	33	34	SPK_N
Not connected	35	36	V_INT	Not connected	35	36	Not connected
Not connected	37	38	Not connected	Not connected	37	38	Not connected
Not connected	39	40	Not connected	Not connected	39	40	Not connected
GND	41	42	GND	GND	41	42	Not connected

Table 7: Pin-out of the 42-pin dual-in-line board-to-board connectors (J402, J403)

 The pins / interfaces that are not supported by a specific LENA-R8 product version should not be driven by an external device. For the features supported by each LENA-R8 product version, see the LENA-R8 series data sheet [\[2\]](#) and the LENA-R8 series system integration manual [\[3\]](#).

5.6 Current consumption measurement

To measure the current consumption of the LENA-R8 module cellular system, remove the jumper socket from the Cellular VCC supply jumper, (**J102** on the ADP-R8), as shown in [Figure 7](#).

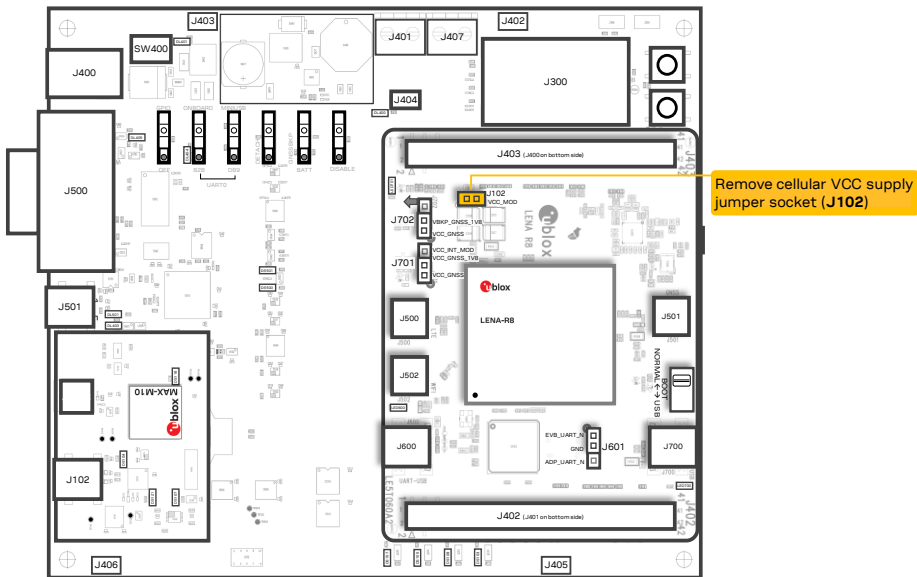

Figure 7: Jumper socket to be removed for cellular module's current consumption measurement

A suitable external digital multi-meter (as the Keysight 34465A, 34410A or 34411A) can be used for current consumption measurements: in this example, the 3.8 V supply circuit on the EVB will supply the cellular module, with the digital multi-meter placed in series as illustrated in [Figure 8](#).

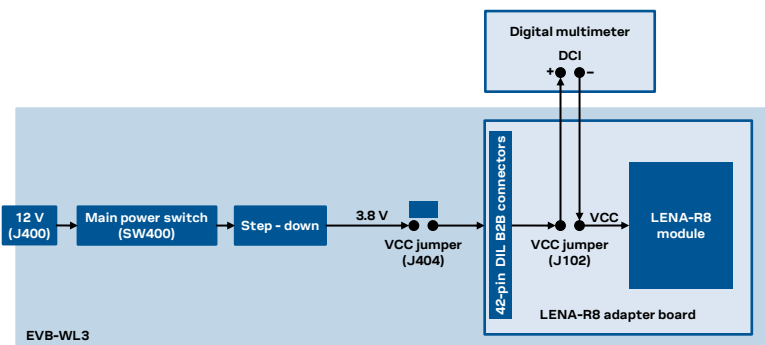

Figure 8: Setup for cellular module's current consumption measurement using a current meter

Alternatively, a suitable external DC power supply with the dynamic current measurement capabilities (e.g., the portable and cheap Qoitech Otii Arc, or the more accurate Keysight N6705B, or the models designed for mobile communications Keysight 66319B/D or 66321B/D) can be used, acting also as 3.8 V supply source for the cellular module mounted on the adapter board, as illustrated in [Figure 9](#).

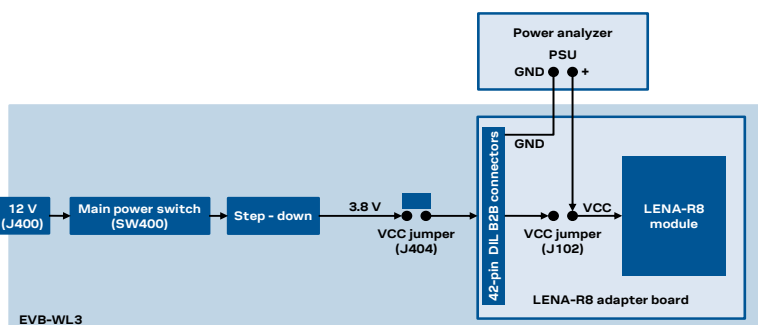

Figure 9: Setup for cellular module's current consumption measurement using a DC power analyzer

Appendix

A Setting up AT terminal application

The u-blox m-center cellular module evaluation tool is a powerful platform for evaluating, configuring and testing u-blox cellular products. m-center includes an AT commands terminal for communication with the device and can be downloaded for free from www.u-blox.com. For m-center example scripts, visit <https://github.com/u-blox/m-center>.

1. Follow the board setup instructions in [section 2](#) to provide all the required connections and switching on the cellular module.
2. Run the m-center tool: after the m-center start-up, the **Home** page appears as shown in [Figure 10](#).

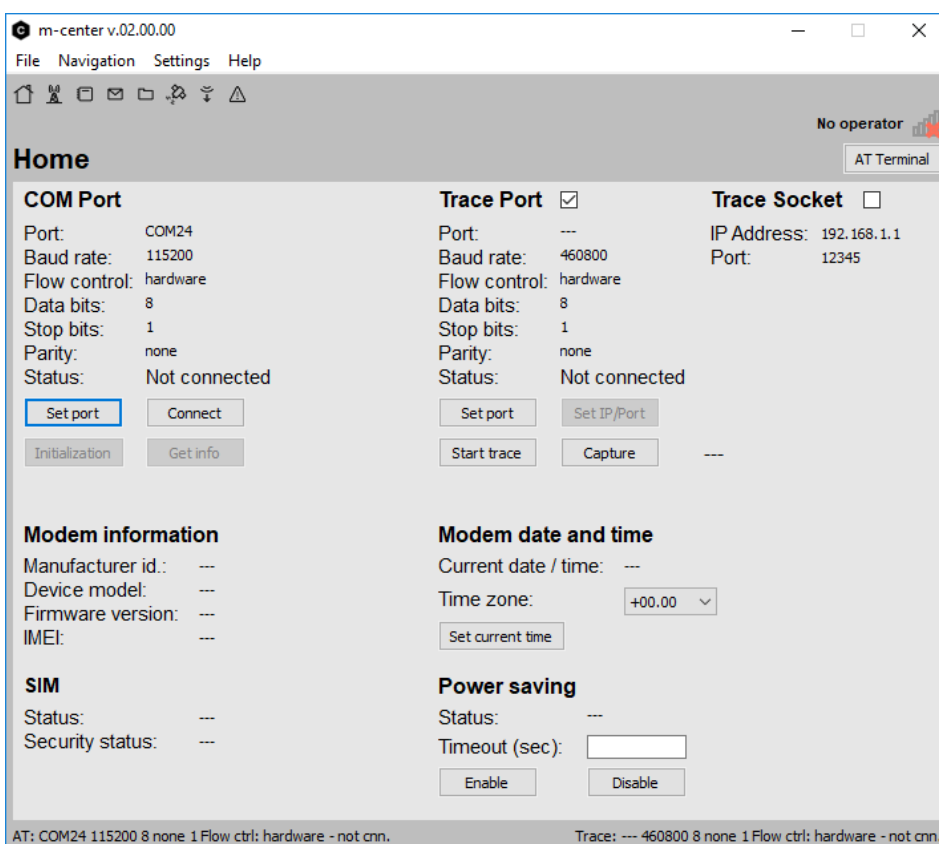

Figure 10: m-center Home page

3. On the **Home** page, set up the AT COM port with setting values below:
 - o Data rate: 115200 bit/s
 - o Data bits: 8
 - o Parity: N
 - o Stop bits: 1
 - o Flow control: HW
4. Check in Windows Device Manager to find out which COM port is being used by the EVK-R8.
5. Enable the connection to u-blox cellular module by clicking on the **Connect** button.
6. Retrieve the module and network information by clicking on the **Get Info** button.
7. The module information is retrieved and displayed on the **Home** page.

- Click on the **AT Terminal** button, found at the upper right of the **Home** page. A new window opens and the AT-command terminal is now ready for communication with the EVK-R8.

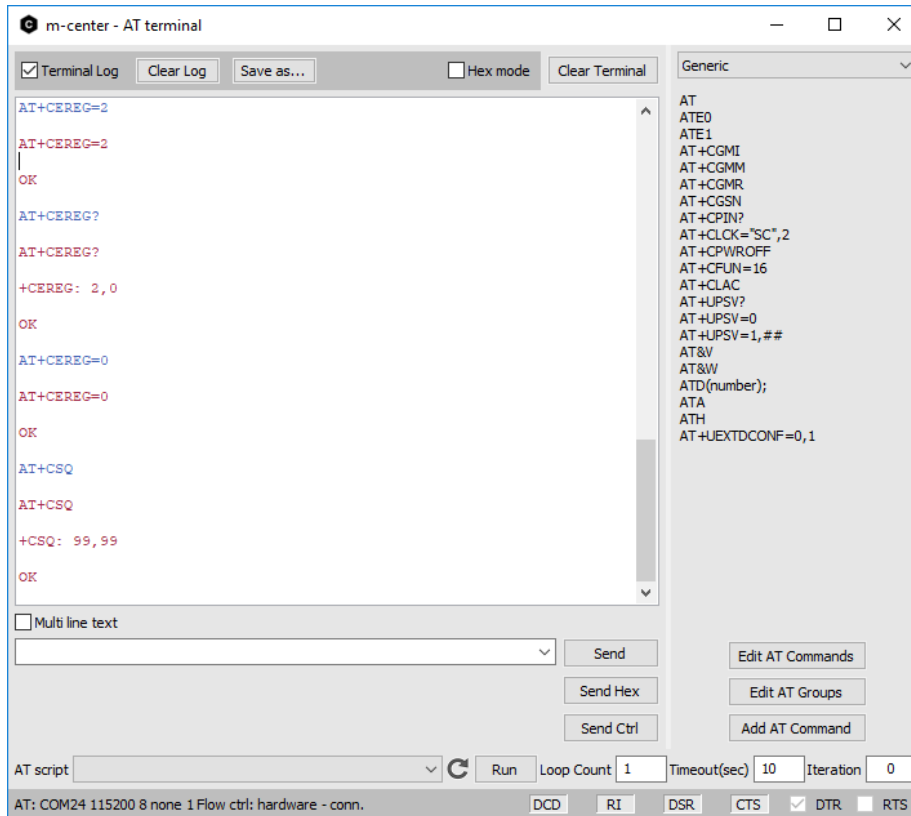

Figure 11: AT Terminal window

- The AT terminal is ready to use.

For more information on using the u-blox m-center, press the **F1** key to open the m-center help window on the computer.

For the complete list of AT commands supported by the modules and their syntax, see the u-blox AT commands manual [\[1\]](#).

B Glossary

Abbreviation	Definition
ADP	Adapter Board
APN	Access Point Name
AT	AT Command Interpreter Software Subsystem, or attention
B2B	Board-To-Board
CS	Circuit Switched
CTS	Clear To Send
DCI	Direct Current
DDC	Display Data Channel
DIL	Dual In Line
EPS	Evolved Packet System
EVB	Evaluation Board
EVK	Evaluation Kit
GND	Ground
GNSS	Global Navigation Satellite System
GPIO	General Purpose Input Output
GPRS	General Packet Radio Service
IMS	IP Multimedia Subsystem
LDO	Low Drop-Out
LED	Light Emitting Diode
LTE	Long Term Evolution
NVM	Non-Volatile Memory
PIN	Personal Identification Number
PS	Packet Switch
PSU	Power Supply Unit
RAT	Radio Access Technology
RF	Radio Frequency
RI	Ring Indicator
UART	Universal Asynchronous Receiver-Transmitter
URC	Unsolicited Result Code
VCC	Voltage Common Collector

C Declaration of conformities

The equipment is intended for indoor usage. It is the user's duty to verify if further restrictions apply, such as in airplanes, hospitals, or hazardous locations (petrol stations, refineries, etc.).

Any changes or modification made to this equipment will void its compliance to the safety requirements.

Maintenance, inspections and/or repairs of the EVK-R8 shall be performed by u-blox AG.