

### FEATURES

#### Very low quiescent current

 $I_Q = 590 \text{ nA}$  with 0  $\mu\text{A}$  load

 $I_Q = 890 \text{ nA}$  with 1  $\mu\text{A}$  load

#### Maintains very low quiescent current in dropout (pass through mode)

 $I_{Q\_DROP} = 720 \text{ nA}$  with 0  $\mu\text{A}$  load

 $I_{Q\_DROP} = 1200 \text{ nA}$  with 1  $\mu\text{A}$  load

#### Stable with 1 $\mu\text{F} \pm 30\%$ ceramic input and output capacitors

#### Maximum operating load current ( $I_{LOAD\_MAX}$ ): 150 mA

#### Input voltage range: 2.2 V to 5.5 V

#### Low shutdown current: 50 nA typical

#### Low dropout voltage: 120 mV at 150 mA load

#### Initial output voltage accuracy: $\pm 1\%$

#### Accuracy over line, load, and temperature: $\pm 3.5\%$

#### 7 fixed output voltage options: 1.2 V to 3.3 V

#### Adjustable output option can be set from 1.0 V to 4.2 V

#### PSRR: 72 dB at 100 Hz, $V_{OUT} = 1.2 \text{ V}$

#### Current-limit and thermal overload protection

#### Logic control enable

#### Integrated output discharge resistor

#### Three package options

5-lead TSOT package

 6-lead, 2 mm  $\times$  2 mm LFCSP

4-ball, 0.5 mm pitch WLCSP

### APPLICATIONS

#### Portable and battery-powered equipment

#### Post dc-to-dc regulation

#### Portable medical devices

#### Wireless sensor network (WSN) devices

### GENERAL DESCRIPTION

The ADP165/ADP166 are very low quiescent current, low dropout (LDO), linear regulators that operate from 2.2 V to 5.5 V and provide up to 150 mA of output current. The low 120 mV dropout voltage at a 150 mA load improves efficiency and allows operation over a wide input voltage range.

The ADP165/ADP166 are specifically designed for stable operation with a tiny 1  $\mu\text{F} \pm 30\%$  ceramic input and output capacitors to meet the requirements of high performance, space constrained applications.

### TYPICAL APPLICATION CIRCUITS

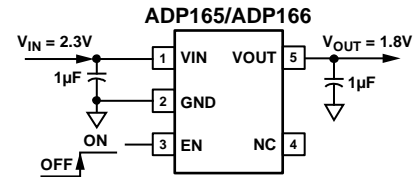

#### NOTES

1. NC = NO CONNECT. NOT CONNECTED INTERNALLY.

12188-001

Figure 1. 5-Lead TSOT ADP165/ADP166 with Fixed Output Voltage, 1.8 V

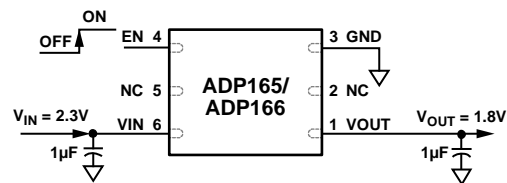

#### NOTES

1. NC = NO CONNECT. NOT CONNECTED INTERNALLY.

12188-002

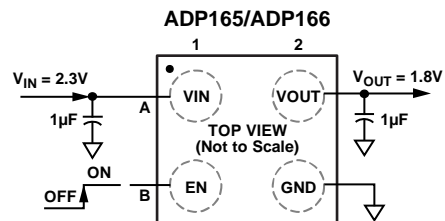
 Figure 2. 6-Lead, 2 mm  $\times$  2 mm LFCSP ADP165/ADP166 with Fixed Output Voltage, 1.8 V

12188-003

Figure 3. 4-Ball WLCSP ADP165/ADP166 with Fixed Output Voltage, 1.8 V

The ADP165/ADP166 are available in seven fixed output voltage options, ranging from 1.2 V to 3.3 V, and an adjustable output option. The ADP165 also includes a switched resistor to discharge the output automatically when the LDO is disabled. The ADP166 is identical to the ADP165, but it does not include the output discharge function.

Short-circuit and thermal overload protection circuits prevent damage in adverse conditions. The ADP165/ADP166 are available in a tiny 5-lead TSOT, a 6-lead LFCSP, and a 4-ball, 0.5 mm pitch WLCSP package for the smallest footprint solution to meet a variety of portable power applications.

**TABLE OF CONTENTS**

|   |   |  |    |
|---|---|--|----|
| Features .....  | 1 | Theory of Operation .....                          | 13 |
| Applications.....                                       | 1 | Applications Information .....                     | 15 |
| Typical Application Circuits.....                       | 1 | Capacitor Selection .....                          | 15 |
| General Description .....                               | 1 | Enable Feature .....                               | 16 |
| Revision History .....                                  | 2 | Undervoltage Lockout (UVLO) .....                  | 16 |
| Specifications.....                                     | 3 | Current-Limit and Thermal Overload Protection..... | 16 |
| Recommended Specifications: Input and Output Capacitors | 4 | Thermal Considerations.....                        | 17 |
| Absolute Maximum Ratings.....                           | 5 | PCB Layout Considerations.....                     | 20 |
| Thermal Data .....                                      | 5 | Light Sensitivity of WLCSPs .....                  | 21 |
| Thermal Resistance .....                                | 5 | Outline Dimensions .....                           | 22 |
| ESD Caution.....  | 5 | Ordering Guide .....                               | 23 |
| Pin ConfigurationS and Function Descriptions.....       | 6 |  |    |
| Typical Performance Characteristics .....               | 9 |  |    |

**REVISION HISTORY**

**11/14—Rev. 0 to Rev. A**

|   |    |
|---|----|
| Change to Features Section .....            | 1  |
| Change to Theory of Operation Section ..... | 13 |

**9/14—Revision 0: Initial Version**

## SPECIFICATIONS

$V_{IN} = (V_{OUT} + 0.5 V)$  or 2.2 V, whichever is greater,  $EN = V_{IN}$ ,  $I_{OUT} = 10 \text{ mA}$ ,  $C_{IN} = C_{OUT} = 1 \mu\text{F}$ ,  $T_A = 25^\circ\text{C}$ ,  $T_J = -40^\circ\text{C}$  to  $+125^\circ\text{C}$  for minimum/maximum specifications, unless otherwise noted.

Table 1.

| Parameter  | Symbol                         | Test Conditions/Comments  | Min  | Typ   | Max  | Unit             |
|--|--------------------------------|---|------|-------|------|------------------|
| INPUT VOLTAGE RANGE                              | $V_{IN}$                       | $T_J = -40^\circ\text{C}$ to $+125^\circ\text{C}$   | 2.2  |       | 5.5  | V                |
| OPERATING SUPPLY CURRENT                         | $I_Q$                          | $I_{OUT} = 0 \mu\text{A}$ , $T_A = 25^\circ\text{C}$  |      | 590   | 1250 | nA               |
|  |                                | $I_{OUT} = 0 \mu\text{A}$ , $T_J = -40^\circ\text{C}$ to $+125^\circ\text{C}$   |      |       | 2.4  | $\mu\text{A}$    |
|  |                                | $I_{OUT} = 1 \mu\text{A}$ , $T_A = 25^\circ\text{C}$  |      | 890   | 1800 | nA               |
|  |                                | $I_{OUT} = 1 \mu\text{A}$ , $T_J = -40^\circ\text{C}$ to $+125^\circ\text{C}$   |      |       | 3.0  | $\mu\text{A}$    |
|  |                                | $I_{OUT} = 100 \mu\text{A}$ , $T_A = 25^\circ\text{C}$  |      | 2.6   | 4.8  | $\mu\text{A}$    |
|  |                                | $I_{OUT} = 100 \mu\text{A}$ , $T_J = -40^\circ\text{C}$ to $+125^\circ\text{C}$   |      |       | 6.2  | $\mu\text{A}$    |
|  |                                | $I_{OUT} = 10 \text{ mA}$ , $T_A = 25^\circ\text{C}$  |      | 11    | 19   | $\mu\text{A}$    |
|  |                                | $I_{OUT} = 150 \text{ mA}$ , $T_A = 25^\circ\text{C}$   |      | 42    | 65   | $\mu\text{A}$    |
| SUPPLY CURRENT IN DROPOUT<br>(PASS THROUGH MODE) | $I_{Q\_DROPOUT}$               | $I_{OUT} = 0 \mu\text{A}$ , $V_{IN} = V_{OUT} - 0.2 \text{ V}$ , $T_A = 25^\circ\text{C}$   |      | 720   | 1600 | nA               |
|  |                                | $I_{OUT} = 0 \mu\text{A}$ , $V_{IN} = V_{OUT} - 0.2 \text{ V}$ , $T_J = -40^\circ\text{C}$ to $+125^\circ\text{C}$                            |      |       | 2.7  | $\mu\text{A}$    |
|  |                                | $I_{OUT} = 1 \mu\text{A}$ , $V_{IN} = V_{OUT} - 0.2 \text{ V}$ , $T_A = 25^\circ\text{C}$   |      | 1200  | 2400 | nA               |
|  |                                | $I_{OUT} = 1 \mu\text{A}$ , $V_{IN} = V_{OUT} - 0.2 \text{ V}$ , $T_J = -40^\circ\text{C}$ to $+125^\circ\text{C}$                            |      |       | 3.5  | $\mu\text{A}$    |
| SHUTDOWN CURRENT                                 | $I_{GND\_SD}$                  | $EN = \text{GND}$   |      | 50    |      | nA               |
|  |                                | $EN = \text{GND}$ , $T_J = -40^\circ\text{C}$ to $+125^\circ\text{C}$   |      |       | 1    | $\mu\text{A}$    |
| FIXED OUTPUT VOLTAGE ACCURACY                    | $V_{OUT\_ACCURACY}$            | $I_{OUT} = 10 \text{ mA}$ , $T_A = 25^\circ\text{C}$  | -1   |       | +1   | %                |
|  |                                | $0 \mu\text{A} < I_{OUT} < 150 \text{ mA}$ , $V_{IN} = (V_{OUT} + 0.5 \text{ V})$ to 5.5 V, $T_A = 25^\circ\text{C}$                          | -2   |       | +2   | %                |
|  |                                | $0 \mu\text{A} < I_{OUT} < 150 \text{ mA}$ , $V_{IN} = (V_{OUT} + 0.5 \text{ V})$ to 5.5 V, $T_J = -40^\circ\text{C}$ to $+125^\circ\text{C}$ | -3.5 |       | +3.5 | %                |
| ADJ PIN VOLTAGE ACCURACY <sup>1</sup>            | $V_{ADJ}$                      | $I_{OUT} = 10 \text{ mA}$   | 0.99 | 1.0   | 1.01 | V                |
|  |                                | $0 \mu\text{A} < I_{OUT} < 150 \text{ mA}$ , $V_{IN} = (V_{OUT} + 0.5 \text{ V})$ to 5.5 V  | 0.98 |       | 1.02 | V                |
|  |                                | $0 \mu\text{A} < I_{OUT} < 150 \text{ mA}$ , $V_{IN} = (V_{OUT} + 0.5 \text{ V})$ to 5.5 V, $T_J = -40^\circ\text{C}$ to $+125^\circ\text{C}$ | 0.97 |       | 1.03 | V                |
|  |                                |   |      |       |      |                  |
| REGULATION                                       | $\Delta V_{OUT}/\Delta V_{IN}$ | $V_{IN} = (V_{OUT} + 0.5 \text{ V})$ to 5.5 V, $T_J = -40^\circ\text{C}$ to $+125^\circ\text{C}$  | -0.1 |       | +0.1 | %/V              |
|  |                                | $I_{OUT} = 100 \mu\text{A}$ to 150 mA   |      | 0.004 | 0.01 | %/mA             |
| DROPOUT VOLTAGE <sup>3</sup>                     | $V_{DROPOUT}$                  | $V_{OUT} = 3.3 \text{ V}$   |      |       |      |                  |
|  |                                | $I_{OUT} = 10 \text{ mA}$   |      | 45    | 110  | mV               |
|  |                                | $I_{OUT} = 150 \text{ mA}$  |      | 120   | 225  | mV               |
| ADJ PIN INPUT BIAS CURRENT                       | $ADJ\_BIAS$                    | $2.2 \text{ V} \leq V_{IN} \leq 5.5 \text{ V}$ , ADJ connected to VOUT  |      | 10    |      | nA               |
| ACTIVE PULL-DOWN RESISTANCE<br>(ADP165)          | $R_{PULL\_DOWN}$               | $V_{OUT} = 3.3 \text{ V}$ , $R_{LOAD} = \infty$   |      | 300   | 600  | $\Omega$         |
| START-UP TIME <sup>4</sup>                       | $T_{START\_UP}$                | $V_{OUT} = 3.3 \text{ V}$   |      | 1100  |      | $\mu\text{s}$    |
| MAXIMUM OPERATING LOAD CURRENT                   | $I_{LOAD\_MAX}$                |   |      | 150   |      | mA               |
| CURRENT-LIMIT THRESHOLD <sup>5</sup>             | $I_{LIMIT}$                    |   | 215  | 320   | 500  | mA               |
| THERMAL SHUTDOWN                                 | $TS_{SD}$                      | $T_J$ rising  |      | 150   |      | $^\circ\text{C}$ |
|  |                                |   |      | 15    |      | $^\circ\text{C}$ |
| EN INPUT   | $V_{IH}$                       | $2.2 \text{ V} \leq V_{IN} \leq 5.5 \text{ V}$  | 1.2  |       |      | V                |
|  |                                | $2.2 \text{ V} \leq V_{IN} \leq 5.5 \text{ V}$  |      |       | 0.4  | V                |
|  |                                | $EN = V_{IN}$ or GND  |      | 0.1   |      | $\mu\text{A}$    |
| EN Input Leakage Current                         | $V_{I\_LEAKAGE}$               | $EN = V_{IN}$ or GND, $T_J = -40^\circ\text{C}$ to $+125^\circ\text{C}$   |      |       | 1    | $\mu\text{A}$    |

| Parameter                    | Symbol               | Test Conditions/Comments  | Min  | Typ | Max  | Unit   |
|------------------------------|----------------------|---|------|-----|------|--------|
| UNDERVOLTAGE LOCKOUT (UVLO)  |                      |   |      |     |      |        |
| Input Voltage Rising         | UVLO <sub>RISE</sub> |   |      |     | 2.19 | V      |
| Input Voltage Falling        | UVLO <sub>FALL</sub> |   | 1.60 |     |      | V      |
| Hysteresis                   | UVLO <sub>HYS</sub>  |   |      | 85  |      | mV     |
| OUTPUT NOISE                 | OUT <sub>NOISE</sub> | 10 Hz to 100 kHz, V <sub>IN</sub> = 5 V, V <sub>OUT</sub> = 3.3 V |      | 105 |      | μV rms |
|                              |                      | 10 Hz to 100 kHz, V <sub>IN</sub> = 5 V, V <sub>OUT</sub> = 2.5 V |      | 100 |      | μV rms |
|                              |                      | 10 Hz to 100 kHz, V <sub>IN</sub> = 5 V, V <sub>OUT</sub> = 1.2 V |      | 80  |      | μV rms |
| POWER SUPPLY REJECTION RATIO | PSRR                 | 100 Hz, V <sub>IN</sub> = 5 V, V <sub>OUT</sub> = 3.3 V           |      | 60  |      | dB     |
|                              |                      | 100 Hz, V <sub>IN</sub> = 5 V, V <sub>OUT</sub> = 2.5 V           |      | 65  |      | dB     |
|                              |                      | 100 Hz, V <sub>IN</sub> = 5 V, V <sub>OUT</sub> = 1.2 V           |      | 72  |      | dB     |
|                              |                      | 1 kHz, V <sub>IN</sub> = 5 V, V <sub>OUT</sub> = 3.3 V            |      | 50  |      | dB     |
|                              |                      | 1 kHz, V <sub>IN</sub> = 5 V, V <sub>OUT</sub> = 2.5 V            |      | 50  |      | dB     |
|                              |                      | 1 kHz, V <sub>IN</sub> = 5 V, V <sub>OUT</sub> = 1.2 V            |      | 62  |      | dB     |

<sup>1</sup> Accuracy when V<sub>OUT</sub> is connected directly to ADJ. When the V<sub>OUT</sub> voltage is set by the external feedback resistors, the absolute accuracy in adjust mode depends on the tolerances of the resistors used.

<sup>2</sup> Based on an endpoint calculation using 0 μA and 150 mA loads.

<sup>3</sup> Dropout voltage is defined as the input-to-output voltage differential when the input voltage is set to the nominal output voltage. This applies only for output voltages above 2.2 V.

<sup>4</sup> Start-up time is defined as the time between the rising edge of EN to V<sub>OUT</sub> being at 90% of its nominal value.

<sup>5</sup> Current-limit threshold is defined as the current at which the output voltage drops to 90% of the specified typical value. For example, the current limit for a 3.0 V output voltage is defined as the current that causes the output voltage to drop to 90% of 3.0 V, or 2.7 V.

## RECOMMENDED SPECIFICATIONS: INPUT AND OUTPUT CAPACITORS

Table 2.

| Parameter   | Symbol                             | Test Conditions/Comments  | Min   | Typ | Max | Unit |
|---|------------------------------------|---|-------|-----|-----|------|
| INPUT AND OUTPUT CAPACITOR                        |                                    |   |       |     |     |      |
| Minimum Input and Output Capacitance <sup>1</sup> | C <sub>IN</sub> ; C <sub>OUT</sub> | C <sub>IN</sub> and C <sub>OUT</sub> tolerance = ±30%, T <sub>A</sub> = -40°C to +125°C | 0.7   | 1   |     | μF   |
| Capacitor Effective Series Resistance (ESR)       | R <sub>ESR</sub>                   | T <sub>A</sub> = -40°C to +125°C  | 0.001 |     | 0.2 | Ω    |

<sup>1</sup> The minimum input and output capacitance must be greater than 0.7 μF over the full range of operating conditions. The full range of operating conditions in the application must be considered during device selection to ensure that the minimum capacitance specification is met. X7R and X5R type capacitors are recommended; however, Y5V and Z5U capacitors are not recommended for use with any LDO.

## ABSOLUTE MAXIMUM RATINGS

Table 3.

| Parameter                            | Rating           |
|--------------------------------------|------------------|
| VIN to GND                           | −0.3 V to +6.5 V |
| VOU to GND                           | −0.3 V to VIN    |
| EN to GND                            | −0.3 V to VIN    |
| ADJ to GND                           | −0.3 V to VIN    |
| NC to GND                            | −0.3 V to VIN    |
| Storage Temperature Range            | −65°C to +150°C  |
| Operating Junction Temperature Range | −40°C to +125°C  |
| Operating Ambient Temperature Range  | −40°C to +125°C  |
| Soldering Conditions                 | JEDEC J-STD-020  |

Stresses at or above those listed under Absolute Maximum Ratings may cause permanent damage to the product. This is a stress rating only; functional operation of the product at these or any other conditions above those indicated in the operational section of this specification is not implied. Operation beyond the maximum operating conditions for extended periods may affect product reliability.

### THERMAL DATA

Absolute maximum ratings only apply individually; they do not apply in combination. The ADP165/ADP166 can be damaged when the junction temperature limits are exceeded. Monitoring ambient temperature does not guarantee that the junction temperature ( $T_J$ ) is within the specified temperature limits. In applications with high power dissipation and poor thermal resistance, the maximum ambient temperature may have to be derated.

In applications with moderate power dissipation and low printed circuit board (PCB) thermal resistance, the maximum ambient temperature can exceed the maximum limit as long as the junction temperature is within specification limits.  $T_J$  is dependent on the ambient temperature ( $T_A$ ), the power dissipation of the device ( $P_D$ ), and the junction-to-ambient thermal resistance of the package ( $\theta_{JA}$ ).

Maximum  $T_J$  is calculated from  $T_A$  and  $P_D$  using the formula

$$T_J = T_A + (P_D \times \theta_{JA})$$

Junction-to-ambient thermal resistance ( $\theta_{JA}$ ) of the package is based on modeling and calculation using a 4-layer board. The junction-to-ambient thermal resistance is highly dependent on the application and board layout. In applications where high maximum power dissipation exists, close attention to thermal board design is required. The value of  $\theta_{JA}$  may vary, depending on PCB material, layout, and environmental conditions. The specified values of  $\theta_{JA}$  are based on a 4-layer, 4 inches  $\times$  3 inches, circuit board. Refer to JESD 51-7 and JESD 51-9 for detailed information on the board construction.

$\Psi_{JB}$  is the junction to board thermal characterization parameter with units of °C/W.  $\Psi_{JB}$  of the package is based on modeling and calculation using a 4-layer board. The JESD51-12, *Guidelines for Reporting and Using Electronic Package Thermal Information*, states that thermal characterization parameters are not the same as thermal resistances.  $\Psi_{JB}$  measures the component power flowing through multiple thermal paths rather than a single path as in thermal resistance ( $\theta_{JB}$ ). Therefore,  $\Psi_{JB}$  thermal paths include convection from the top of the package as well as radiation from the package, factors that make  $\Psi_{JB}$  more useful in real-world applications. Maximum  $T_J$  is calculated from the board temperature ( $T_B$ ) and  $P_D$  using the formula

$$T_J = T_B + (P_D \times \Psi_{JB})$$

Refer to JESD51-8 and JESD51-12 for more detailed information about  $\Psi_{JB}$ .

### THERMAL RESISTANCE

$\theta_{JA}$  and  $\Psi_{JB}$  are specified for worst-case conditions, that is, a device soldered in a circuit board for surface-mount packages.

Table 4. Thermal Resistance

| Package Type               | $\theta_{JA}$ | $\Psi_{JB}$ | Unit |
|----------------------------|---------------|-------------|------|
| 5-Lead TSOT                | 170           | 43          | °C/W |
| 6-Lead LFCSP               | 50.2          | 18.2        | °C/W |
| 4-Ball, 0.4 mm Pitch WLCSP | 260           | 58          | °C/W |

### ESD CAUTION



**ESD (electrostatic discharge) sensitive device.** Charged devices and circuit boards can discharge without detection. Although this product features patented or proprietary protection circuitry, damage may occur on devices subjected to high energy ESD. Therefore, proper ESD precautions should be taken to avoid performance degradation or loss of functionality.

## PIN CONFIGURATIONS AND FUNCTION DESCRIPTIONS

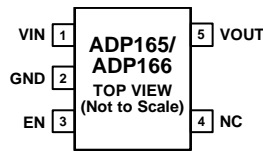

NOTES  
 1. NC = NO CONNECT. NOT CONNECTED INTERNALLY.

12188-004

Figure 4. 5-Lead TSOT, Fixed Output Pin Configuration

Table 5. Fixed Output, 5-Lead TSOT Pin Function Descriptions

| Pin No. | Mnemonic | Description   |
|---------|----------|---|
| 1       | VIN      | Regulator Input Supply. Bypass VIN to GND with a 1 $\mu$ F or greater capacitor.  |
| 2       | GND      | Ground.   |
| 3       | EN       | Enable Input. Drive EN high to turn on the regulator; drive EN low to turn off the regulator. For automatic startup, connect EN to VIN. |
| 4       | NC       | No Connect. This pin is not connected internally.   |
| 5       | VOUT     | Regulated Output Voltage. Bypass VOUT to GND with a 1 $\mu$ F or greater capacitor.   |

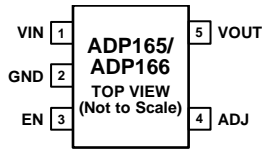

12188-005

Figure 5. 5-Lead TSOT, Adjustable Output Pin Configuration

Table 6. Adjustable Output, 5-Lead TSOT Pin Function Descriptions

| Pin No. | Mnemonic | Description   |
|---------|----------|---|
| 1       | VIN      | Regulator Input Supply. Bypass VIN to GND with a 1 $\mu$ F or greater capacitor.  |
| 2       | GND      | Ground.   |
| 3       | EN       | Enable Input. Drive EN high to turn on the regulator; drive EN low to turn off the regulator. For automatic startup, connect EN to VIN. |
| 4       | ADJ      | Output Voltage Adjust Pin. Connect the midpoint of the voltage divider between VOUT and GND to this pin to set the output voltage.      |
| 5       | VOUT     | Regulated Output Voltage. Bypass VOUT to GND with a 1 $\mu$ F or greater capacitor.   |

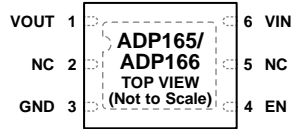

NOTES  
 1. NC = NO CONNECT. NOT CONNECTED INTERNALLY.  
 2. THE EXPOSED PAD MUST BE CONNECTED TO GROUND. THE EXPOSED PAD ENHANCES THE THERMAL PERFORMANCE OF THE PACKAGE.

12188-006

Figure 6. 6-Lead LFCSP, Fixed Output Pin Configuration

Table 7. Fixed Output, 6-Lead LFCSP Pin Function Descriptions

| Pin No. | Mnemonic    | Description  |
|---------|-------------|--|
| 1       | VOUT        | Regulated Output Voltage. Bypass VOUT to GND with a 1 $\mu$ F or greater capacitor.  |
| 2       | NC          | No Connect. This pin is not connected internally.  |
| 3       | GND         | Ground.  |
| 4       | EN          | Enable Input. Drive EN high to turn on the regulator; drive EN low to turn off the regulator. For automatic startup, connect EN to VIN.  |
| 5       | NC          | No Connect. This pin is not connected internally. Connect this pin to GND or leave open.   |
| 6       | VIN<br>EPAD | Regulator Input Supply. Bypass VIN to GND with a 1 $\mu$ F or greater capacitor.<br>Exposed Pad. The exposed pad must be connected to ground. The exposed pad enhances the thermal performance of the package. |

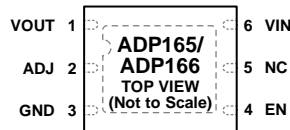

NOTES  
 1. NC = NO CONNECT. NOT CONNECTED INTERNALLY.  
 2. THE EXPOSED PAD MUST BE CONNECTED TO GROUND. THE EXPOSED PAD ENHANCES THE THERMAL PERFORMANCE OF THE PACKAGE.

12188-007

Figure 7. 6-Lead LFCSP, Adjustable Output Pin Configuration

Table 8. Adjustable Output, 6-Lead LFCSP Pin Function Descriptions

| Pin No. | Mnemonic    | Description  |
|---------|-------------|--|
| 1       | VOUT        | Regulated Output Voltage. Bypass VOUT to GND with a 1 $\mu$ F or greater capacitor.  |
| 2       | ADJ         | Output Voltage Adjust Pin. Connect the midpoint of the voltage divider between VOUT and GND to this pin to set the output voltage.   |
| 3       | GND         | Ground.  |
| 4       | EN          | Enable Input. Drive EN high to turn on the regulator; drive EN low to turn off the regulator. For automatic startup, connect EN to VIN.  |
| 5       | NC          | No Connect. This pin is not connected internally.  |
| 6       | VIN<br>EPAD | Regulator Input Supply. Bypass VIN to GND with a 1 $\mu$ F or greater capacitor.<br>Exposed Pad. The exposed pad must be connected to ground. The exposed pad enhances the thermal performance of the package. |

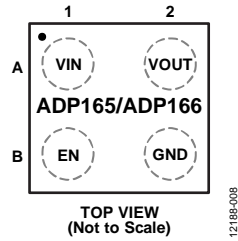

Figure 8. 4-Ball WLCSP Pin Configuration

Table 9. 4-Ball WLCSP Pin Function Descriptions

| Pin No. | Mnemonic | Description   |
|---------|----------|---|
| A1      | VIN      | Regulator Input Supply. Bypass VIN to GND with a 1 $\mu$ F or greater capacitor.  |
| B1      | EN       | Enable Input. Drive EN high to turn on the regulator; drive EN low to turn off the regulator. For automatic startup, connect EN to VIN. |
| A2      | VOUT     | Regulated Output Voltage. Bypass VOUT to GND with a 1 $\mu$ F or greater capacitor.   |
| B2      | GND      | Ground.   |



# TYPICAL PERFORMANCE CHARACTERISTICS

$V_{IN} = 3.8\text{ V}$ ,  $V_{OUT} = 3.3\text{ V}$ ,  $I_{OUT} = 1\text{ mA}$ ,  $C_{IN} = C_{OUT} = 1\text{ }\mu\text{F}$ ,  $T_A = 25^\circ\text{C}$ , unless otherwise noted.

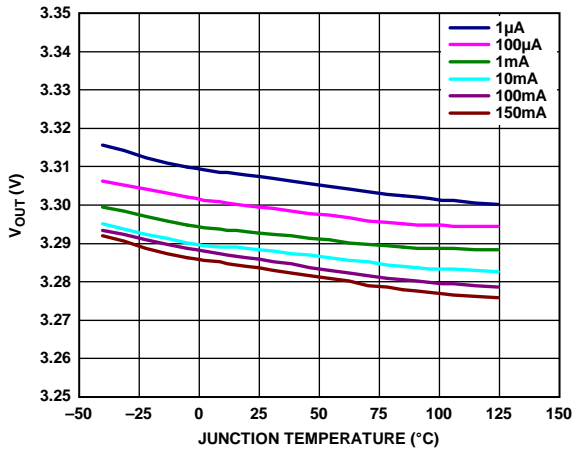

Figure 9. Output Voltage ( $V_{OUT}$ ) vs. Junction Temperature

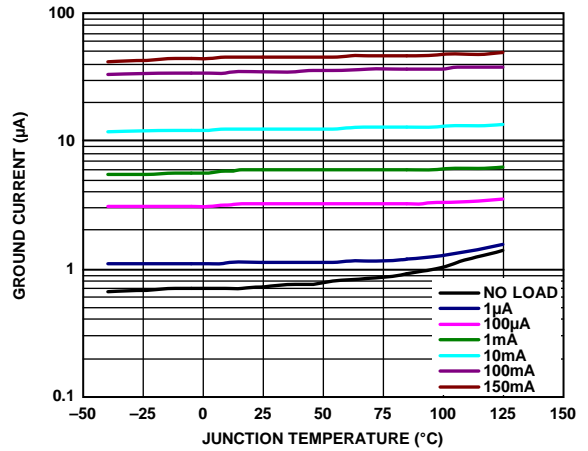

Figure 12. Ground Current vs. Junction Temperature

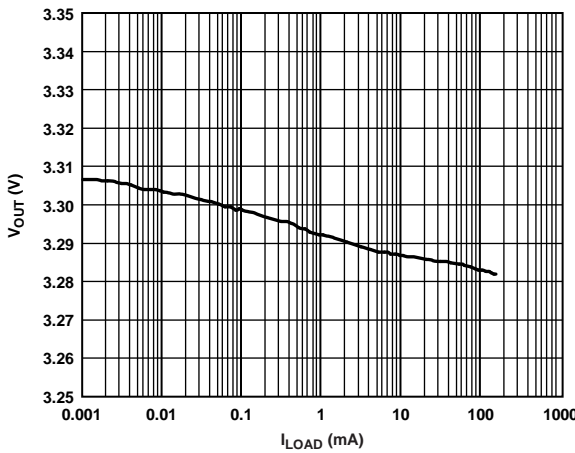

Figure 10. Output Voltage ( $V_{OUT}$ ) vs. Load Current ( $I_{LOAD}$ )

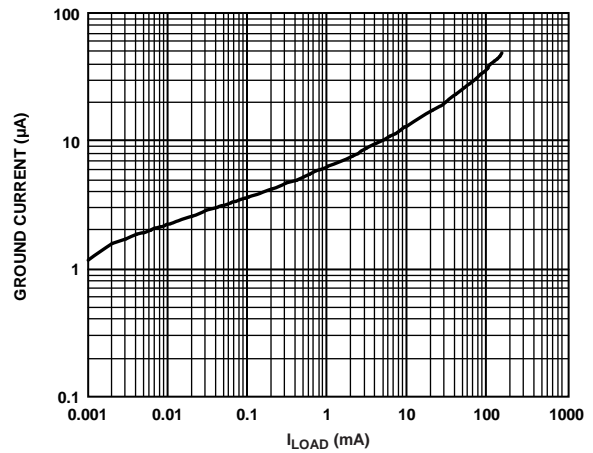

Figure 13. Ground Current vs. Load Current ( $I_{LOAD}$ )

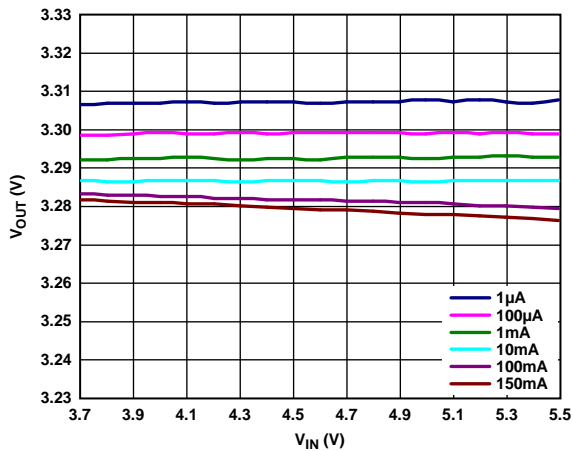

Figure 11. Output Voltage ( $V_{OUT}$ ) vs. Input Voltage ( $V_{IN}$ )

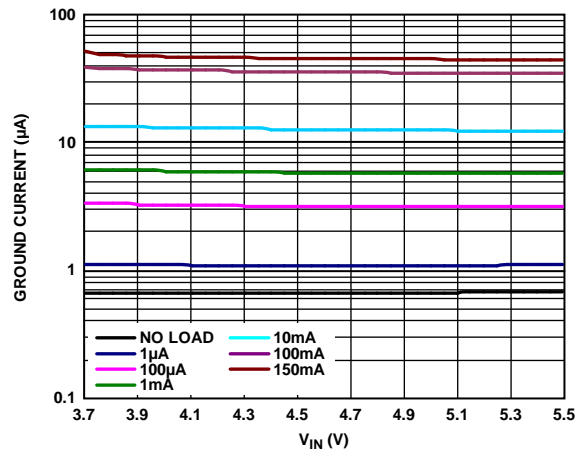

Figure 14. Ground Current vs. Input Voltage ( $V_{IN}$ )

12188-109

12188-112

12188-110

12188-113

12188-111

12188-114

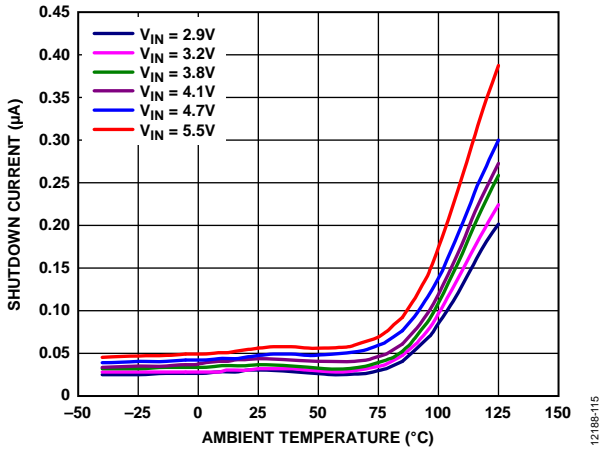

12188-115

Figure 15. Shutdown Current vs. Ambient Temperature at Various Input Voltages

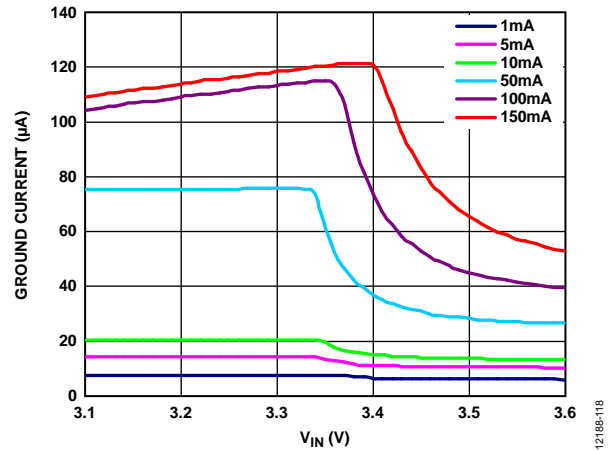

12188-118

Figure 18. Ground Current vs. Input Voltage ( $V_{IN}$ ) in Dropout

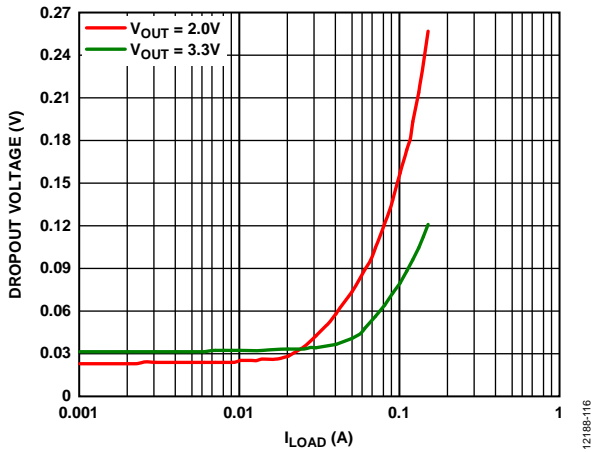

12188-116

Figure 16. Dropout Voltage vs. Load Current ( $I_{LOAD}$ )

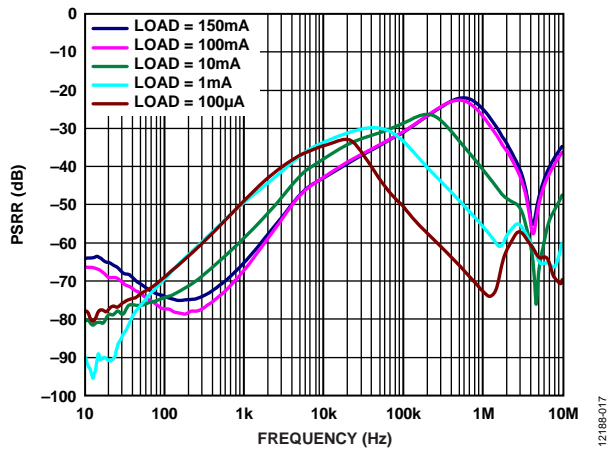

12188-017

Figure 19. Power Supply Rejection Ratio (PSRR) vs. Frequency, Various Load Currents,  $V_{OUT} = 1.2\text{ V}$ ,  $V_{IN} = 2.2\text{ V}$

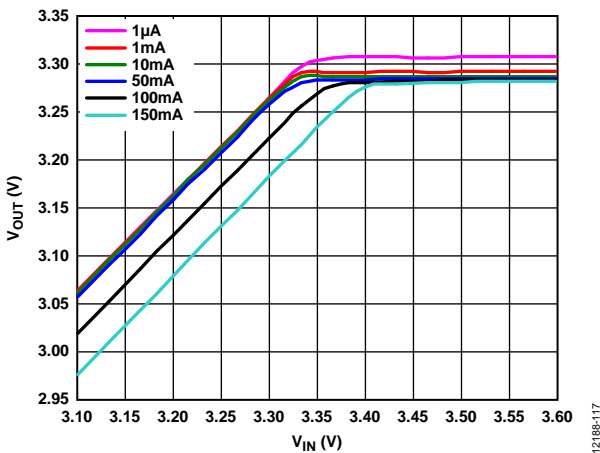

12188-117

Figure 17. Output Voltage ( $V_{OUT}$ ) vs. Input Voltage ( $V_{IN}$ ) in Dropout

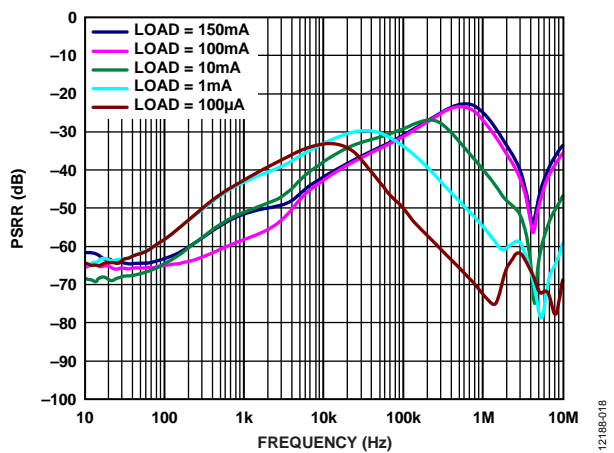

12188-018

Figure 20. PSRR vs. Frequency, Various Load Currents,  $V_{OUT} = 2.5\text{ V}$ ,  $V_{IN} = 3.5\text{ V}$

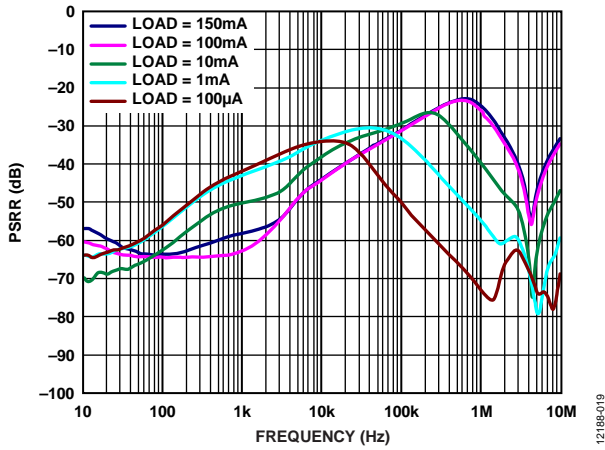

Figure 21. PSRR vs. Frequency, Various Load Currents,  $V_{OUT} = 3.3 V$ ,  $V_{IN} = 4.3 V$

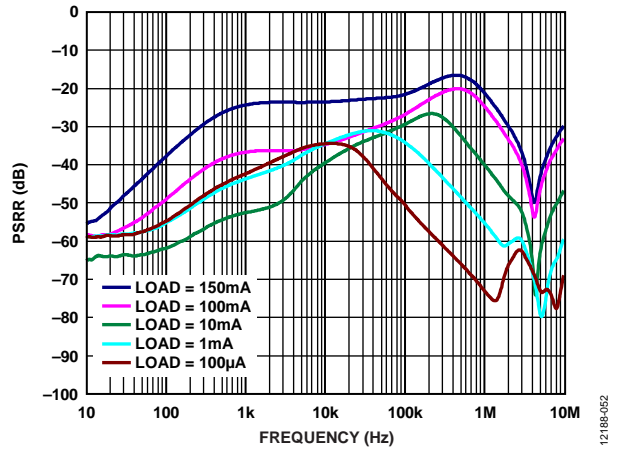

Figure 24. PSRR vs. Frequency, Various Load Currents,  $V_{OUT} = 3.3 V$ ,  $V_{IN} = 3.8 V$

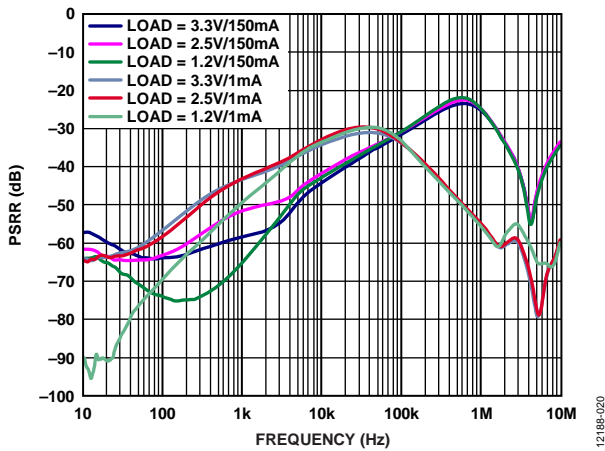

Figure 22. PSRR vs. Frequency, Various Load Currents,  $V_{IN} - V_{OUT} = 1 V$

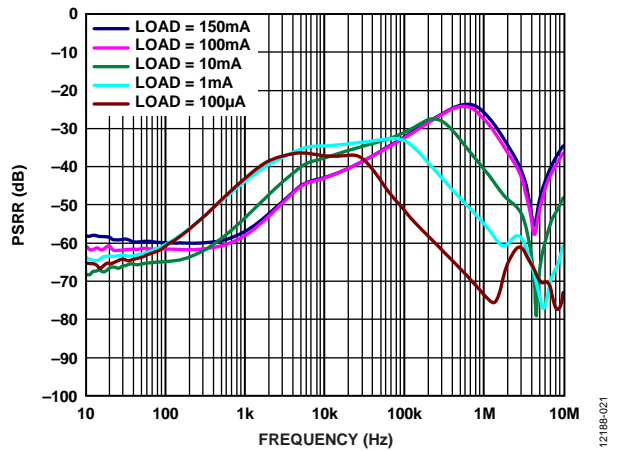

Figure 25. Adjustable ADP165/ADP166 PSRR vs. Frequency, Various Load Currents,  $V_{OUT} = 3.3 V$ ,  $V_{IN} = 4.3 V$

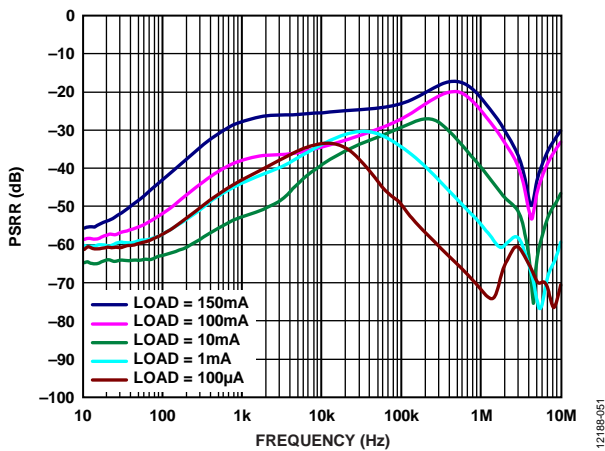

Figure 23. PSRR vs. Frequency, Various Load Currents,  $V_{OUT} = 2.5 V$ ,  $V_{IN} = 3.0 V$

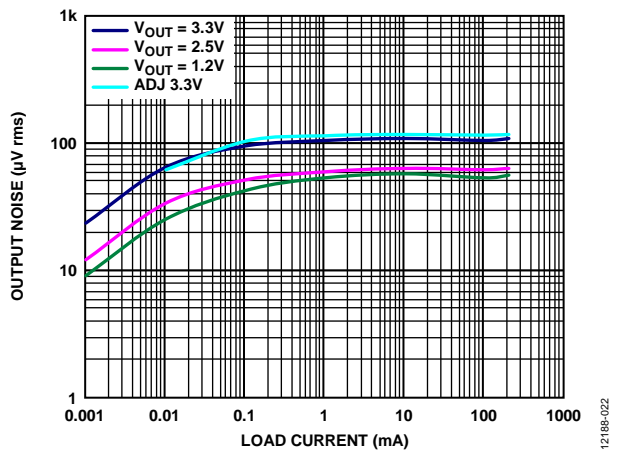

Figure 26. Output Noise vs. Load Current and Output Voltage,  $V_{IN} = 5 V$ ,  $C_{OUT} = 1 \mu F$

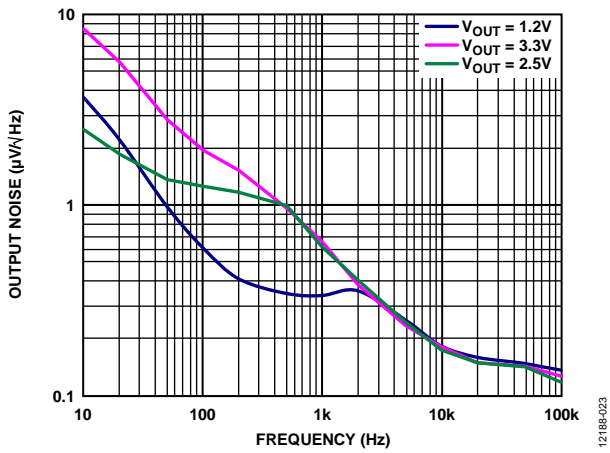

Figure 27. Output Noise Spectral Density,  $V_{IN} = 5\text{ V}$ ,  $I_{LOAD} = 10\text{ mA}$ ,  $C_{OUT} = 1\text{ }\mu\text{F}$

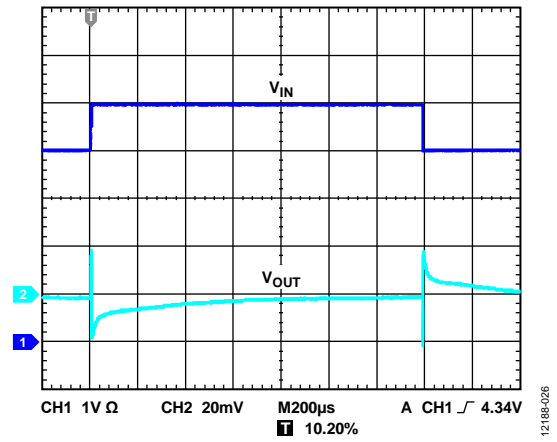

Figure 30. Line Transient Response,  $V_{IN} = 4\text{ V to }5\text{ V}$ ,  $C_{IN} = C_{OUT} = 1\text{ }\mu\text{F}$ ,  $I_{LOAD} = 150\text{ mA}$ , CH1 =  $V_{IN}$ , CH2 =  $V_{OUT}$

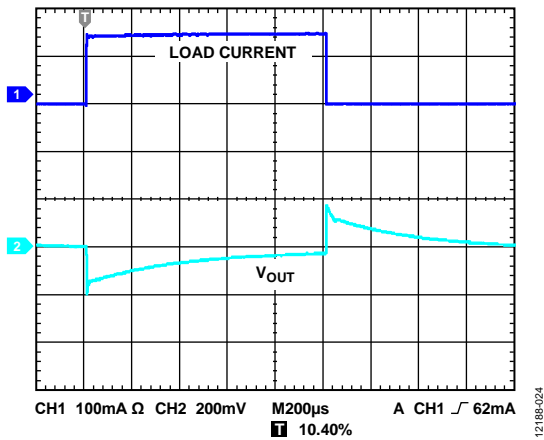

Figure 28. Load Transient Response,  $C_{IN} = C_{OUT} = 1\text{ }\mu\text{F}$ ,  $I_{LOAD} = 1\text{ mA to }150\text{ mA}$ , 200 ns Rise Time, CH1 = Load Current, CH2 =  $V_{OUT}$

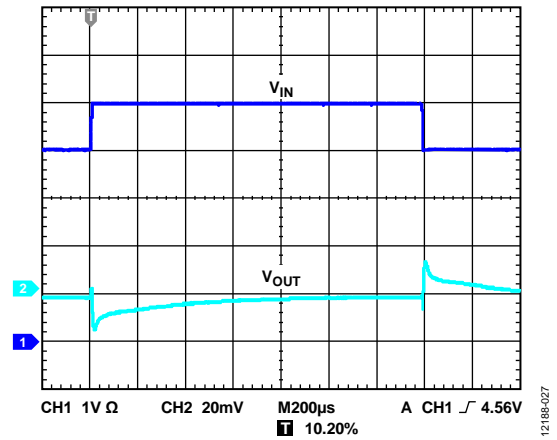

Figure 31. Line Transient Response,  $V_{IN} = 4\text{ V to }5\text{ V}$ ,  $C_{IN} = 1\text{ }\mu\text{F}$ ,  $C_{OUT} = 10\text{ }\mu\text{F}$ ,  $I_{LOAD} = 150\text{ mA}$ , CH1 =  $V_{IN}$ , CH2 =  $V_{OUT}$

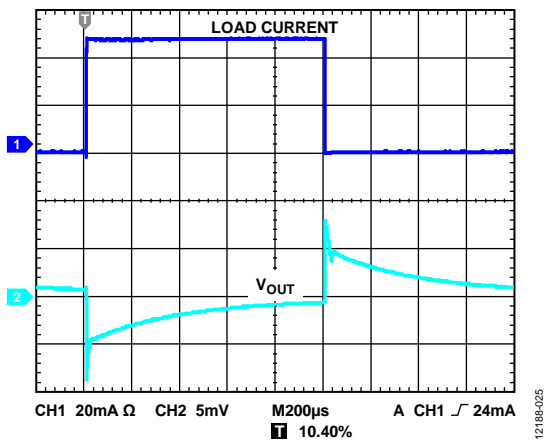

Figure 29. Load Transient Response,  $C_{IN} = C_{OUT} = 1\text{ }\mu\text{F}$ ,  $I_{LOAD} = 1\text{ mA to }50\text{ mA}$ , 200 ns Rise Time, CH1 = Load Current, CH2 =  $V_{OUT}$

### THEORY OF OPERATION

The ADP165/ADP166 are very low quiescent current, low dropout linear regulators that operate from 2.2 V to 5.5 V and can provide up to 150 mA of output current. Drawing only 590 nA (typical) at no load and a low 42 µA of quiescent current (typical) at full load makes the ADP165/ADP166 ideal for battery-operated portable equipment. Shutdown current consumption is typically 50 nA.

Using new innovative design techniques, the ADP165/ADP166 provide very low quiescent current and superior transient performance for digital and RF applications. The ADP165/ADP166 are also optimized for use with small 1 µF ceramic capacitors.

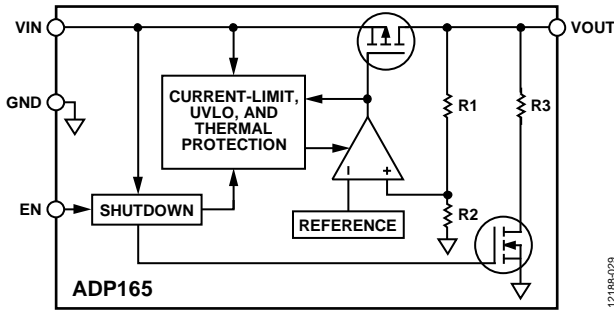

Figure 32. Internal Block Diagram, Fixed Output with Output Discharge Function

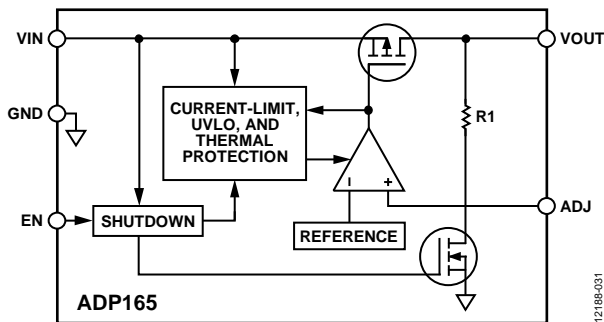

Figure 33. Internal Block Diagram, Adjustable Output with Output Discharge Function

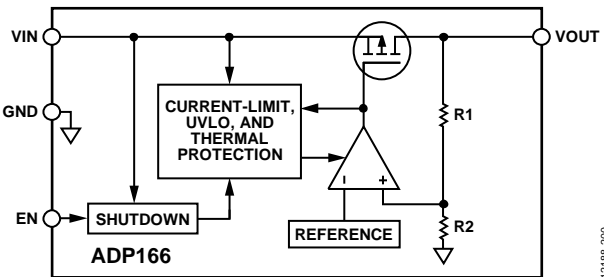

Figure 34. Internal Block Diagram, Fixed Output Without Output Discharge Function

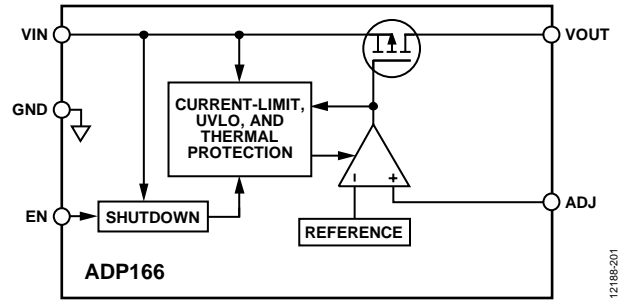

Figure 35. Internal Block Diagram, Adjustable Output Without Output Discharge Function

Internally, the ADP165/ADP166 consist of a reference, an error amplifier, a feedback voltage divider, and a PMOS pass transistor. Output current is delivered via the PMOS pass device, which is controlled by the error amplifier. The error amplifier compares the reference voltage with the feedback voltage from the output and amplifies the difference. If the feedback voltage is lower than the reference voltage, the gate of the PMOS device is pulled lower, allowing more current to pass and increasing the output voltage. If the feedback voltage is higher than the reference voltage, the gate of the PMOS device is pulled higher, allowing less current to pass and decreasing the output voltage.

The adjustable ADP165/ADP166 have an output voltage range of 1.0 V to 4.2 V. The output voltage is set by the ratio of two external resistors, which are the same as the R1 and R2 resistors in Figure 32 and Figure 34, but are connected through the ADJ pin. The device serves the output to maintain the voltage at the ADJ pin at 1.0 V referenced to ground. The current in R1 is then equal to 1.0 V/R2, and the current in R1 is the current in R2 plus the ADJ pin bias current. The ADJ pin bias current, 10 nA at 25°C, flows through R1 into the ADJ pin.

Calculate the output voltage using the following equation:

$$V_{OUT} = 1.0 V(1 + R1/R2) + (ADJ_{I-BIAS})(R1)$$

The value of R1 must be less than 200 kΩ to minimize errors in the output voltage caused by the ADJ pin bias current. For example, when R1 and R2 each equal 200 kΩ, the output voltage is 2.0 V. The output voltage error introduced by the ADJ pin bias current is 2 mV or 0.05%, assuming a typical ADJ pin bias current of 10 nA at 25°C.

To minimize quiescent current in the [ADP165/ADP166](#), Analog Devices, Inc., recommends using high values of resistance for R1 and R2. Using a value of 1 M $\Omega$  for R2 keeps the total, no load quiescent current below 2  $\mu$ A. However, note that a high value of resistance introduces a small output voltage error. For example, assuming R1 and R2 are 1 M $\Omega$ , the output voltage is 2 V. Taking into account the nominal ADJ pin bias current of 10 nA, the output voltage error is 0.25%.

Note that, in shutdown, the output is turned off, and the divider current is zero.

The [ADP165](#) also includes an output discharge resistor to force the output voltage to zero when the LDO is disabled. This ensures that the output of the LDO is always in a well-defined state, whether it is enabled or not. The [ADP166](#) does not include the output discharge function.

The [ADP165/ADP166](#) are available in seven output voltage options, ranging from 1.2 V to 3.3 V. The [ADP165/ADP166](#) use the EN pin to enable and disable the VOUT pin under normal operating conditions. When EN is high, VOUT turns on, and when EN is low, VOUT turns off. For automatic startup, tie EN to VIN.

## APPLICATIONS INFORMATION

### CAPACITOR SELECTION

#### Output Capacitor, $C_{OUT}$

The ADP165/ADP166 are designed for operation with small, space-saving ceramic capacitors, but function with most commonly used capacitors as long as care is taken with regard to the ESR value. The ESR of the output capacitor affects stability of the LDO control loop. A minimum of 1  $\mu\text{F}$  capacitance with an ESR of 1  $\Omega$  or less is recommended to ensure stability of the ADP165/ADP166. Transient response to changes in load current is also affected by output capacitance. Using a larger value of output capacitance improves the transient response of the ADP165/ADP166 to large changes in load current. Figure 36 and Figure 37 show the transient responses for output capacitance values of 1  $\mu\text{F}$  and 10  $\mu\text{F}$ , respectively.

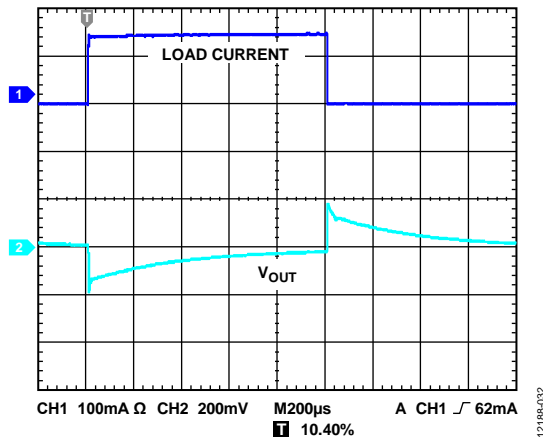

Figure 36. Output Transient Response,  $C_{OUT} = 1 \mu\text{F}$ ,  
CH1 = Load Current, CH2 =  $V_{OUT}$

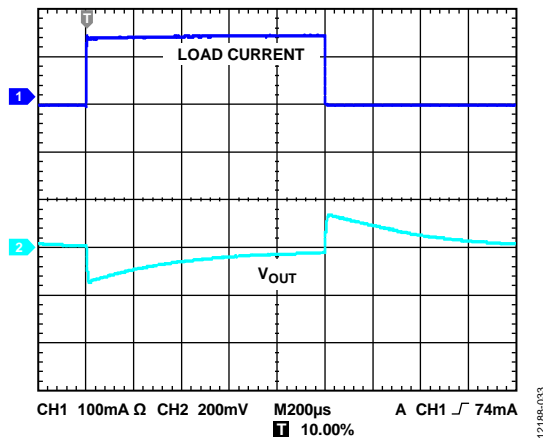

Figure 37. Output Transient Response,  $C_{OUT} = 10 \mu\text{F}$ ,  
CH1 = Load Current, CH2 =  $V_{OUT}$

#### Input Bypass Capacitor, $C_{IN}$

Connecting a 1  $\mu\text{F}$  capacitor from VIN to GND reduces the circuit sensitivity to the PCB layout, especially when long input traces or high source impedance are encountered. If an output capacitance of greater than 1  $\mu\text{F}$  is required, increase the input capacitor to match it.

#### Input and Output Capacitor Properties

Any good quality ceramic capacitors can be used with the ADP165/ADP166, as long as they meet the minimum capacitance and maximum ESR requirements. Ceramic capacitors are manufactured with a variety of dielectrics, each with different behavior over temperature and applied voltage. Capacitors must have a dielectric adequate to ensure the minimum capacitance over the necessary temperature range and dc bias conditions. X5R or X7R dielectrics with a voltage rating of 6.3 V or 10 V are recommended. Y5V and Z5U dielectrics are not recommended due to their poor temperature and dc bias characteristics.

Figure 38 depicts the capacitance vs. voltage bias characteristic of a 0402, 1  $\mu\text{F}$ , 10 V, X5R capacitor. The voltage stability of a capacitor is strongly influenced by the capacitor size and voltage rating. In general, a capacitor in a larger package or higher voltage rating exhibits better stability. The temperature variation of the X5R dielectric is about  $\pm 15\%$  over the  $-40^\circ\text{C}$  to  $+85^\circ\text{C}$  temperature range and is not a function of package or voltage rating.

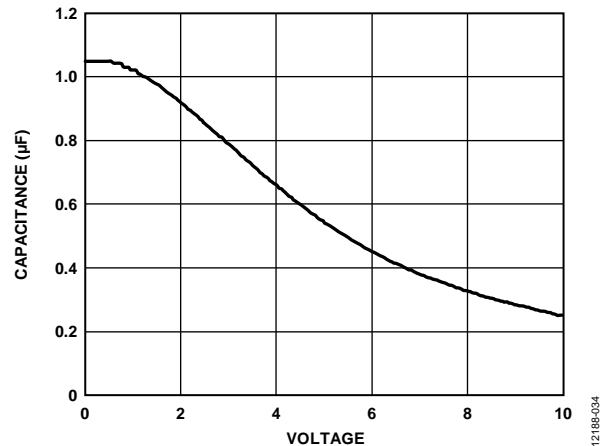

Figure 38. Capacitance vs. Voltage Bias Characteristic

Use Equation 1 to determine the worst-case capacitance accounting for capacitor variation over temperature, component tolerance, and voltage.

$$C_{EFF} = C_{BIAS} \times (1 - TEMPCO) \times (1 - TOL) \quad (1)$$

where:

$C_{BIAS}$  is the effective capacitance at the operating voltage.  
 $TEMPCO$  is the worst-case capacitor temperature coefficient.  
 $TOL$  is the worst-case component tolerance.

In this example, the worst-case temperature coefficient ( $TEMPCO$ ) over the  $-40^\circ\text{C}$  to  $+85^\circ\text{C}$  range is 15% for an X5R dielectric. The tolerance of the capacitor ( $TOL$ ) is 10%, and  $C_{BIAS}$  is 0.94  $\mu\text{F}$  at 1.8 V, as shown in Figure 38.

Substituting these values in Equation 1 yields

$$C_{EFF} = 0.94 \mu\text{F} \times (1 - 0.15) \times (1 - 0.1) = 0.719 \mu\text{F}$$

Therefore, the capacitor chosen in this example meets the minimum capacitance requirement of the LDO over temperature and tolerance at the chosen output voltage.

To guarantee the performance of the ADP165/ADP166, it is imperative that the effects of dc bias, temperature, and tolerances on the behavior of the capacitors are evaluated for each.

**ENABLE FEATURE**

The ADP165/ADP166 use the EN pin to enable and disable the VOUT pin under normal operating conditions. As shown in Figure 39, when a rising voltage on EN crosses the active threshold, VOUT turns on. When a falling voltage on EN crosses the inactive threshold, VOUT turns off.

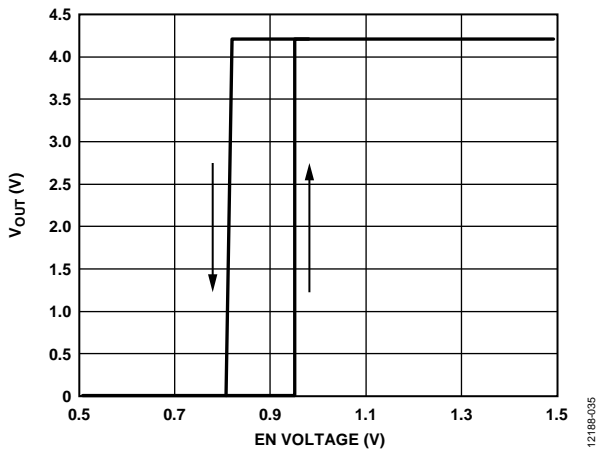

Figure 39. Typical EN Pin Operation

As shown in Figure 39, the EN pin has hysteresis built in, which prevents on/off oscillations that can occur due to noise on the EN pin as it passes through the threshold points.

The EN pin active/inactive thresholds are derived from the VIN voltage. Therefore, these thresholds vary with changing input voltage. Figure 40 shows typical EN active/inactive thresholds when the input voltage varies from 2.2 V to 5.5 V.

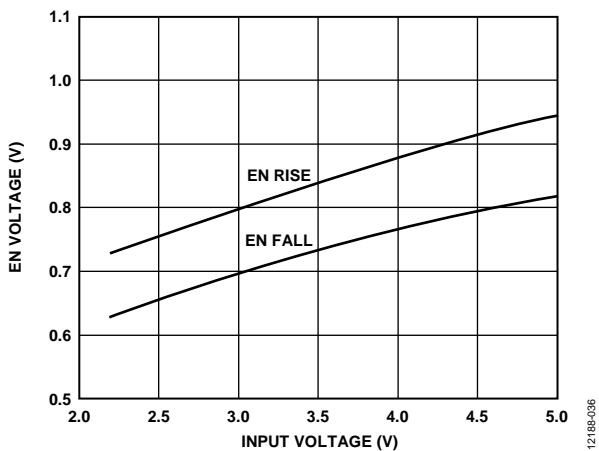

Figure 40. Typical EN Pin Thresholds vs. Input Voltage

The start-up behavior of the ADP165/ADP166 is shown in Figure 41.

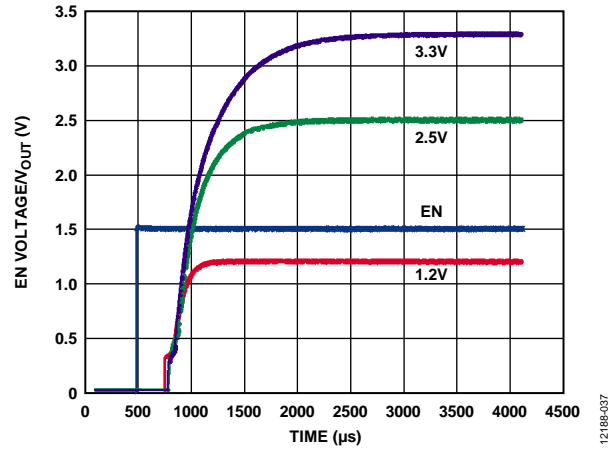

Figure 41. Typical Start-Up Behavior

The shutdown behavior of the ADP165/ADP166 is shown in Figure 42.

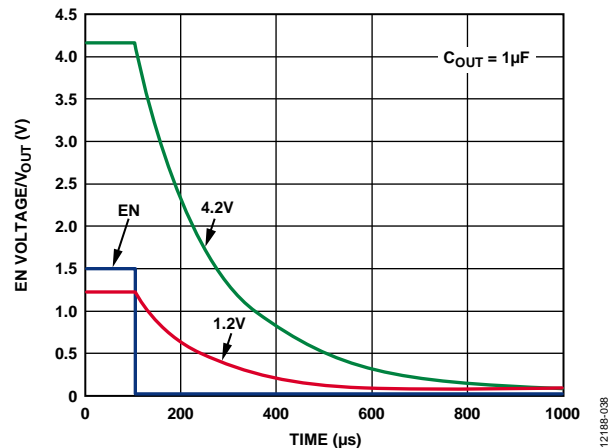

Figure 42. Typical Shutdown Behavior, No Load

**UNDERVOLTAGE LOCKOUT (UVLO)**

The ADP165/ADP166 also incorporates an internal UVLO circuit to disable the output voltage when the input voltage is less than the minimum input voltage rating of the regulator.

**CURRENT-LIMIT AND THERMAL OVERLOAD PROTECTION**

The ADP165/ADP166 are protected against damage due to excessive power dissipation by short-circuit and thermal overload protection circuits. The ADP165/ADP166 are designed to limit current when the output load reaches 320 mA (typical). When the output load exceeds 320 mA, the output voltage is reduced to maintain a constant current limit.

Thermal overload protection is included, which limits the junction temperature to a maximum of 150°C (typical). Under extreme conditions (that is, high ambient temperature and power dissipation), when the junction temperature starts to rise above 150°C, the output turns off, reducing the output current to zero. When the junction temperature drops below 135°C, the output turns on again, and the output current is restored to its nominal value.



Consider the case where a hard short from V<sub>OUT</sub> to ground occurs. At first, the ADP165/ADP166 limit current so that only 320 mA is conducted into the short.

If self-heating of the junction temperature is great enough to cause its temperature to rise above 150°C, thermal shutdown activates, turning off the output and reducing the output current to zero. As the junction temperature cools and drops below 135°C, the output turns on and conducts 320 mA into the short, again causing the junction temperature to rise above 150°C. This thermal oscillation between 135°C and 150°C causes a current oscillation between 320 mA and 0 mA that continues as long as the short remains at the output.

Current and thermal limit protections are intended to protect the device against accidental overload conditions. For reliable operation, device power dissipation must be externally limited so that junction temperatures do not exceed 125°C.

### THERMAL CONSIDERATIONS

In most applications, the ADP165/ADP166 do not dissipate much heat due to their high efficiency. However, in applications with high ambient temperature and high supply voltage to output voltage differential, the heat dissipated in the package is high enough that it can cause the junction temperature of the die to exceed the maximum junction temperature of 125°C.

When the junction temperature exceeds 150°C, the converter enters thermal shutdown. It recovers only after the junction temperature has decreased below 135°C to prevent any permanent damage. Therefore, thermal analysis for the chosen application is very important to guarantee reliable performance over all conditions. The junction temperature of the die is the sum of the ambient temperature of the environment and the temperature rise of the package due to the power dissipation, as shown in Equation 2.

To guarantee reliable operation, the junction temperature of the ADP165/ADP166 must not exceed 125°C. To ensure that the junction temperature stays below this maximum value, the user must be aware of the parameters that contribute to junction temperature changes. These parameters include ambient temperature, power dissipation in the power device, and thermal resistances between the junction and ambient air ( $\theta_{JA}$ ). The  $\theta_{JA}$  number is dependent on the package assembly compounds that are used and the amount of copper used to solder the package GND pins to the PCB.

Table 10 shows the typical  $\theta_{JA}$  values of the 5-lead TSOT, 6-lead LFCSP, and the 4-ball WLCSP for various PCB copper sizes. Table 11 shows the typical  $\Psi_{JB}$  value of the 5-lead TSOT, 6-lead LFCSP, and 4-ball WLCSP.

**Table 10. Typical  $\theta_{JA}$  Values**

| Copper Size (mm <sup>2</sup> ) | $\theta_{JA}$ (°C/W) |       |       |
|--------------------------------|----------------------|-------|-------|
|                                | TSOT                 | LFCSP | WLCSP |
| 0 <sup>1</sup>                 | 170                  | 175.1 | 260   |
| 50                             | 152                  | 135.6 | 159   |
| 100                            | 146                  | 77.3  | 157   |
| 300                            | 134                  | 65.2  | 153   |
| 500                            | 131                  | 51    | 151   |

<sup>1</sup> Device soldered to minimum size pin traces.

**Table 11. Typical  $\Psi_{JB}$  Values**

| Package      | $\Psi_{JB}$ | Unit   |
|--------------|-------------|--------|
| 5-Lead TSOT  | 42.8        | (°C/W) |
| 6-Lead LFCSP | 17.9        | (°C/W) |
| 4-Ball WLCSP | 58.4        | (°C/W) |

Calculate the junction temperature of the ADP165/ADP166 from the following equation:

$$T_J = T_A + (P_D \times \theta_{JA}) \quad (2)$$

where:

$T_A$  is the ambient temperature.

$P_D$  is the power dissipation in the die, given by

$$P_D = [(V_{IN} - V_{OUT}) \times I_{LOAD}] + (V_{IN} \times I_{GND}) \quad (3)$$

where:

$V_{IN}$  and  $V_{OUT}$  are input and output voltages, respectively.

$I_{LOAD}$  is the load current.

$I_{GND}$  is the ground current.

Power dissipation due to ground current is quite small and can be ignored. Therefore, the junction temperature equation simplifies to the following:

$$T_J = T_A + \theta_{JA}[(V_{IN} - V_{OUT}) \times I_{LOAD}] \quad (4)$$

As shown in Equation 4, for a given ambient temperature, input-to-output voltage differential, and continuous load current, there exists a minimum copper size requirement for the PCB to ensure the junction temperature does not rise above 125°C. Figure 43 to Figure 57 show the junction temperature calculations for the different ambient temperatures, load currents, V<sub>IN</sub>-to-V<sub>OUT</sub> differentials, and areas of PCB copper.

In the case where the board temperature is known, use the thermal characterization parameter,  $\Psi_{JB}$ , to estimate the junction temperature rise (see Figure 55 to Figure 57). Maximum junction temperature ( $T_J$ ) is calculated from the board temperature ( $T_B$ ) and power dissipation ( $P_D$ ) using the following formula:

$$T_J = T_B + (P_D \times \Psi_{JB}) \quad (5)$$

The typical value of  $\Psi_{JB}$  is 17.9°C/W for the 6-lead LFCSP package, 42.8°C/W for the 5-lead TSOT package, and 58.4°C/W for the 4-ball WLCSP package.

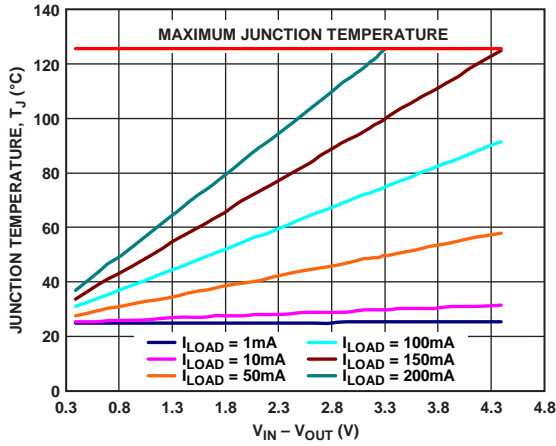

Figure 43. 500 mm<sup>2</sup> of PCB Copper, WLCSP, T<sub>A</sub> = 25°C

12188-039

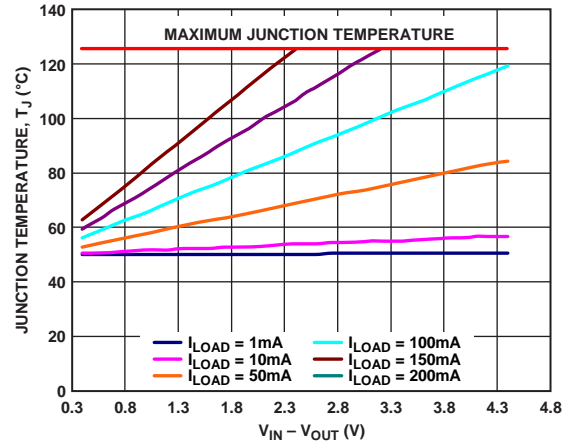

Figure 46. 100 mm<sup>2</sup> of PCB Copper, WLCSP, T<sub>A</sub> = 50°C

12188-042

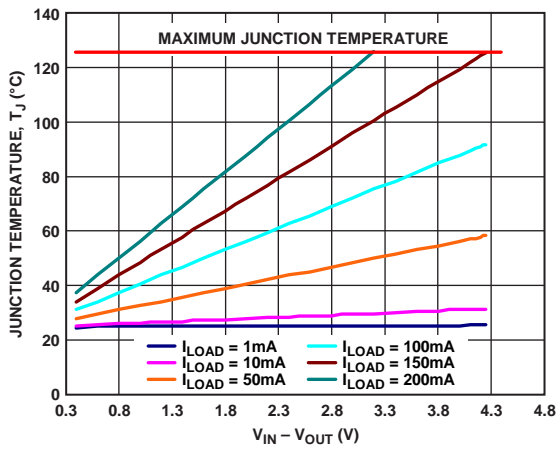

Figure 44. 100 mm<sup>2</sup> of PCB Copper, WLCSP, T<sub>A</sub> = 25°C

12188-040

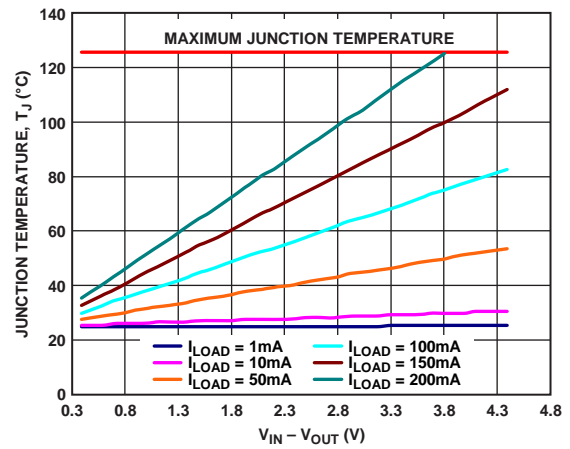

Figure 47. 500 mm<sup>2</sup> of PCB Copper, TSOT, T<sub>A</sub> = 25°C

12188-043

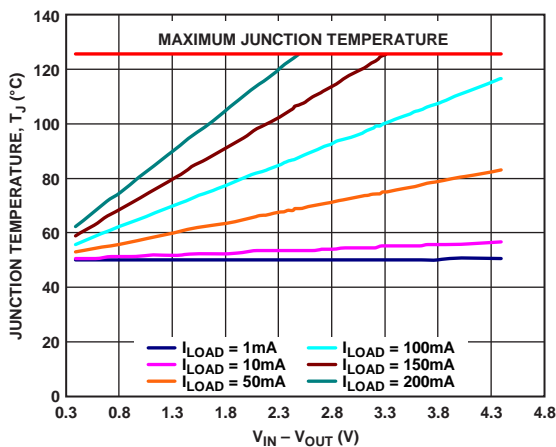

Figure 45. 500 mm<sup>2</sup> of PCB Copper, WLCSP, T<sub>A</sub> = 50°C

12188-041

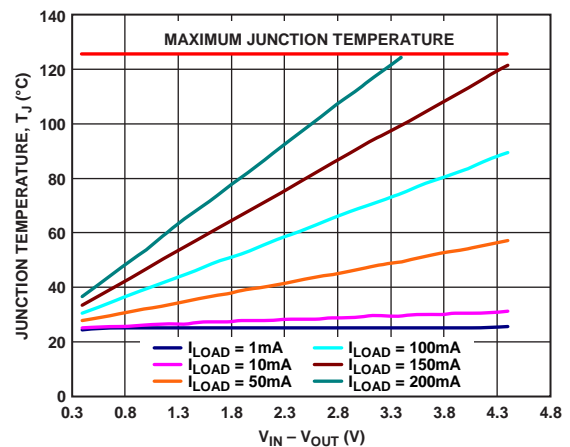

Figure 48. 100 mm<sup>2</sup> of PCB Copper, TSOT, T<sub>A</sub> = 25°C

12188-044

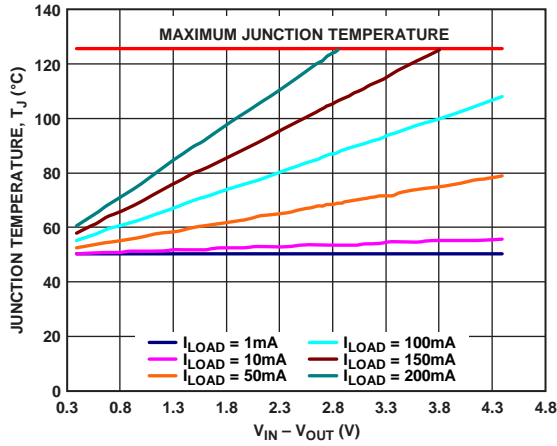

Figure 49. 500 mm<sup>2</sup> of PCB Copper, TSOT, T<sub>A</sub> = 50°C

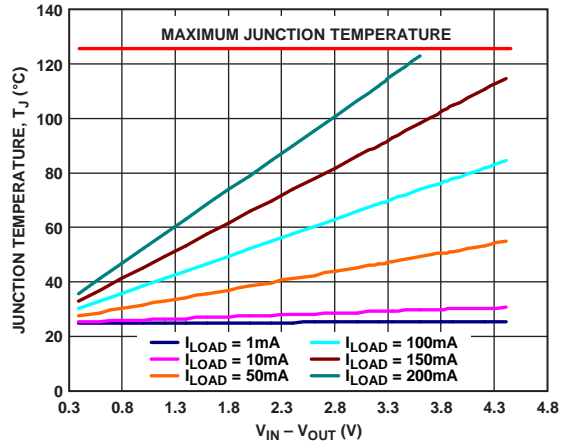

Figure 52. 100 mm<sup>2</sup> of PCB Copper, LFCSPT, T<sub>A</sub> = 25°C

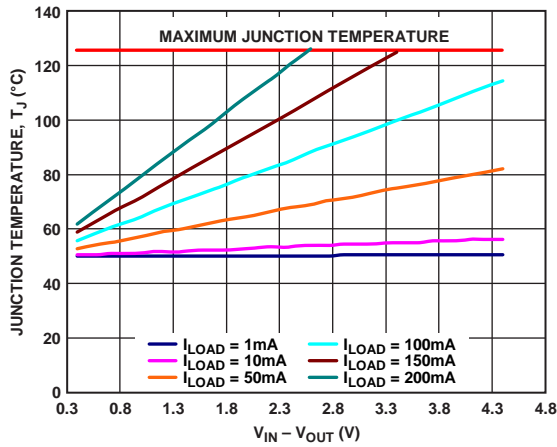

Figure 50. 100 mm<sup>2</sup> of PCB Copper, TSOT, T<sub>A</sub> = 50°C

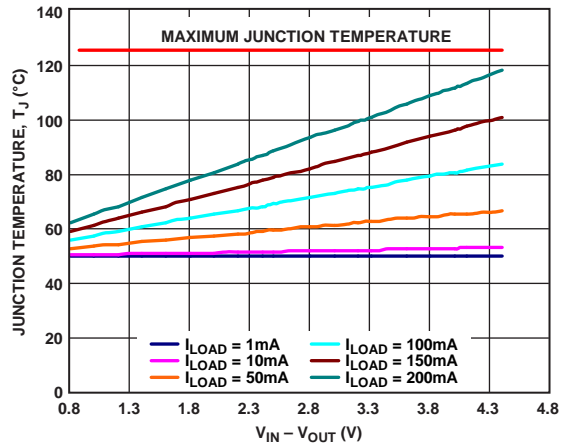

Figure 53. 500 mm<sup>2</sup> of PCB Copper, LFCSPT, T<sub>A</sub> = 50°C

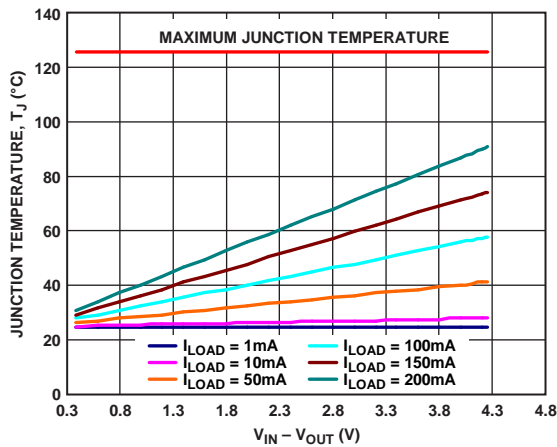

Figure 51. 500 mm<sup>2</sup> of PCB Copper, LFCSPT, T<sub>A</sub> = 25°C

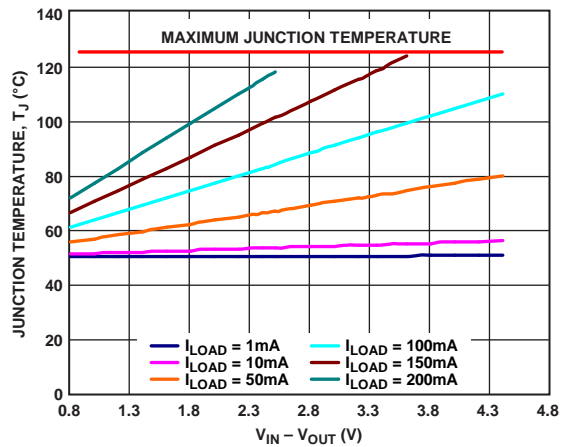

Figure 54. 100 mm<sup>2</sup> of PCB Copper, LFCSPT, T<sub>A</sub> = 50°C

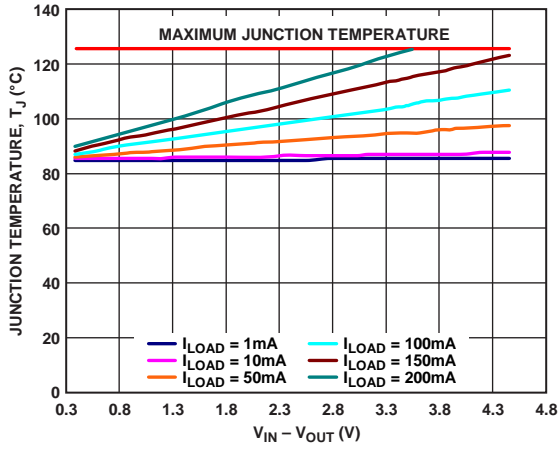

Figure 55. WLCSP,  $T_A = 85^\circ\text{C}$

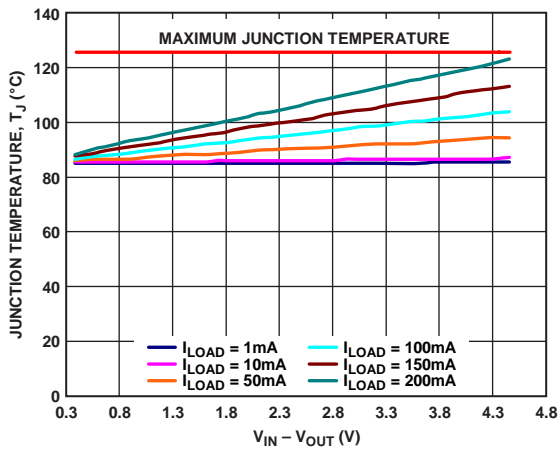

Figure 56. TSOT,  $T_A = 85^\circ\text{C}$

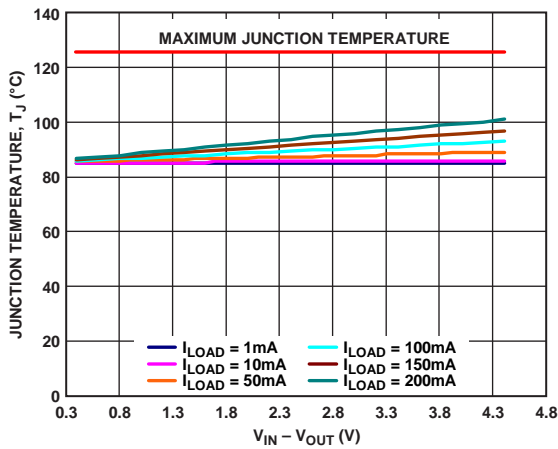

Figure 57. LFCSP,  $T_A = 85^\circ\text{C}$

Heat dissipation from the package can be improved by increasing the amount of copper attached to the pins of the ADP165/ADP166. However, as listed in Table 10, a point of diminishing returns is reached eventually, beyond which an increase in the copper size does not yield significant heat dissipation benefits.

PCB LAYOUT CONSIDERATIONS

Place the input capacitor as close as possible to the VIN pin and the GND pin. Place the output capacitor as close as possible to the VOUT pin and the GND pin. Use of 0402 or 0603 size capacitors and resistors achieves the smallest possible footprint solution on boards where area is limited.

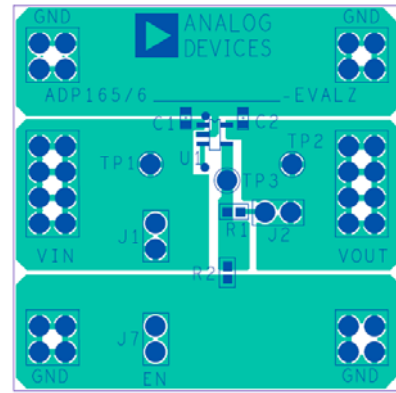

Figure 58. Example of 5-Lead TSOT PCB Layout

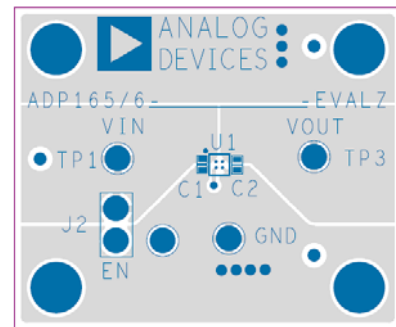

Figure 59. Example of 4-Ball WLCSP PCB Layout

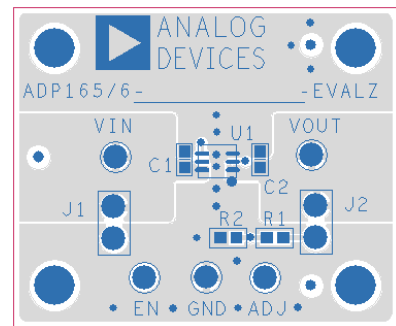

Figure 60. Example of 6-Lead LFCSP PCB Layout

### LIGHT SENSITIVITY OF WLCSPs

The WLCSP package option is essentially a silicon die with additional post fabrication dielectric and metal processing designed to contact solder bumps on the active side of the chip. With this package type, the die is exposed to ambient light and is subject to photoelectric effects. Light sensitivity analysis of a WLCSP mounted on standard PCB material reveals that performance may be impacted when the package is illuminated directly by high intensity light. No degradation in electrical performance is observed due to illumination by low intensity ( $0.1 \text{ mW/cm}^2$ ) ambient light. Direct sunlight can have intensities of  $50 \text{ mW/cm}^2$ , and office ambient light can be as low as  $0.1 \text{ mW/cm}^2$ .

When the WLCSP is assembled on the board with the bump side of the die facing the PCB, reflected light from the PCB surface is incident on active silicon circuit areas and results in the increased leakage currents. No performance degradation occurs due to illumination of the backside (substrate) of the WLCSP.

All WLCSPs are particularly sensitive to incident light with wavelengths in the near infrared range (NIR, 700 nm to 1000 nm). Photons in this waveband have a longer wavelength and lower energy than photons in the visible (400 nm to 700 nm) and near

ultraviolet (NUV, 200 nm to 400 nm) bands; therefore, they can penetrate more deeply into the active silicon.

Incident light with wavelengths greater than 1100 nm has no photoelectric effect on silicon devices because silicon is transparent to wavelengths in this range.

The spectral content of conventional light sources varies considerably. Sunlight has a broad spectral range, with peak intensity in the visible band that falls off in the NUV and NIR bands; fluorescent lamps have significant peaks in the visible but not the NUV or NIR bands. Tungsten lighting has a broad peak in the longer visible wavelengths with a significant tail in the NIR.

Efforts have been made at a product level to reduce the effect of ambient light; the under bump metal (UBM) has been designed to shield the sensitive circuit areas on the active side (bump side) of the die. However, if an application encounters any light sensitivity with the WLCSP, shielding the bump side of the WLCSP package with opaque material eliminates this effect. Shielding can be accomplished using materials such as silica-filled liquid epoxies like those used in flip-chip underfill techniques.

OUTLINE DIMENSIONS

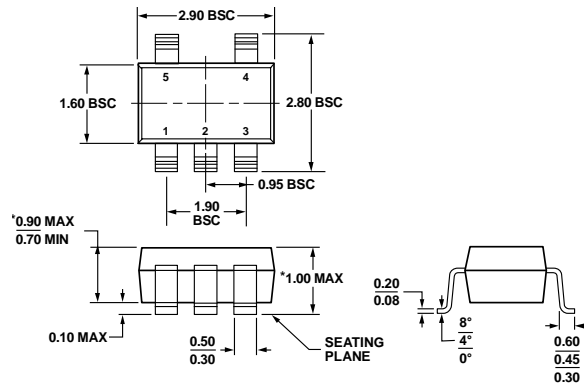

\*COMPLIANT TO JEDEC STANDARDS MO-193-AB WITH THE EXCEPTION OF PACKAGE HEIGHT AND THICKNESS.

Figure 61. 5-Lead Thin Small Outline Transistor Package [TSOT] (UJ-5)

Dimensions shown in millimeters

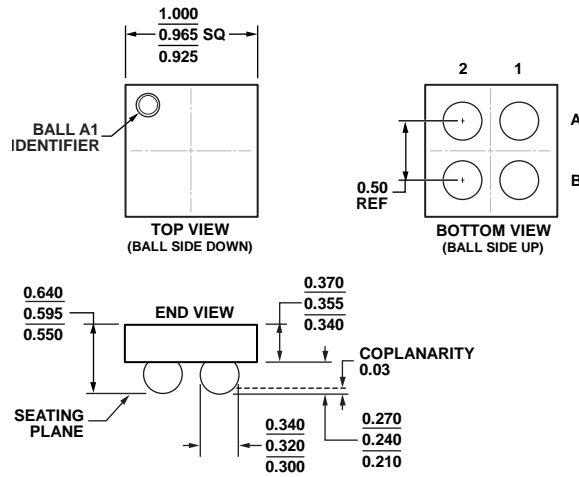

Figure 62. 4-Ball Wafer Level Chip Scale Package [WLCSP] (CB-4-1)

Dimensions shown in millimeters

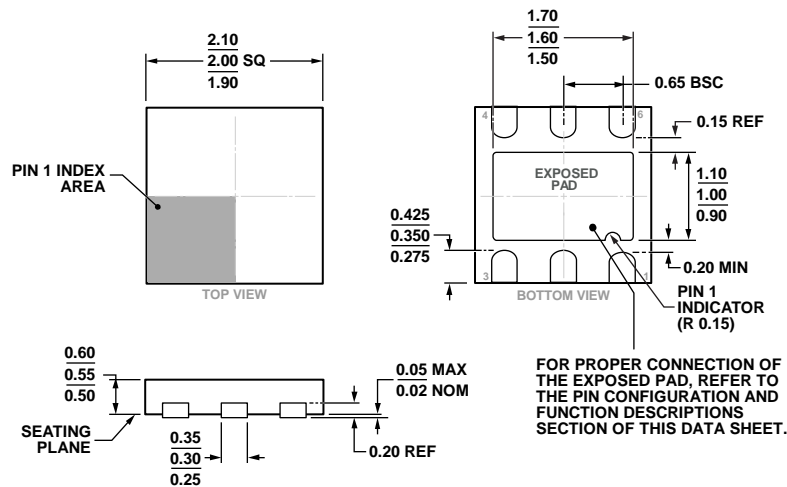

Figure 63. 6-Lead Lead Frame Chip Scale Package [LFCSP\_UD] 2.00 mm x 2.00 mm Body, Ultra Thin, Dual Lead (CP-6-3)

Dimensions show in millimeters