

FEATURES

Ultrawideband frequency range: 9 kHz to 44 GHz

Nonreflective 50 Ω design

Low insertion loss

1.5 dB up to 18 GHz

2.4 dB up to 40 GHz

2.5 dB up to 44 GHz

High isolation

44 dB up to 18 GHz

39 dB up to 40 GHz

36 dB up to 44 GHz

High input linearity

P0.1dB: 26 dBm typical

IP3: 48 dBm typical

High power handling

24 dBm through path

24 dBm terminated path

All off state control

Logic select control

No low frequency spurs

Settling time (0.1 dB final RF output): 6 μ s

24-terminal, 3 mm \times 3 mm LGA package

Pin compatible with [ADRF5042](#), fast switching version

APPLICATIONS

Industrial scanners

Test instrumentation

Cellular infrastructure—millimeterwave (mmWave) 5G

Military radios, radars, electronic counter measures (ECMs)

Microwave radios and very small aperture terminals (VSATs)

GENERAL DESCRIPTION

The ADRF5043 is a nonreflective, SP4T switch manufactured in the silicon on insulator (SOI) process.

The ADRF5043 operates from 9 kHz to 44 GHz with an insertion loss of lower than 2.5 dB and an isolation of higher than 36 dB. The device has a RF input power handling capability of 24 dBm for both through and terminated paths.

The ADRF5043 requires a dual-supply voltage of +3.3 V and -3.3 V. The device employs CMOS- and low voltage transistor to transistor logic (LVTTTL)-compatible controls.

FUNCTIONAL BLOCK DIAGRAM

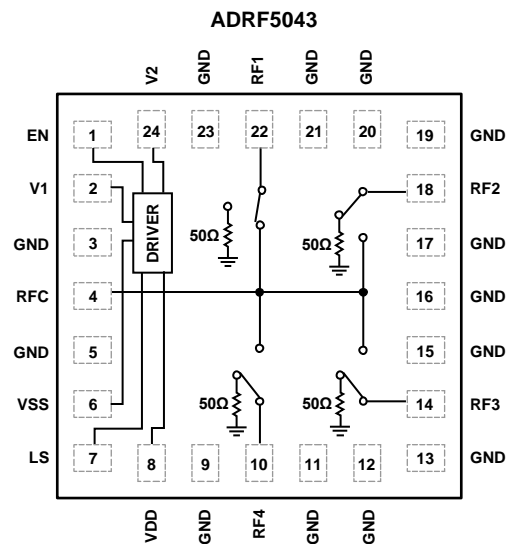

Figure 1.

23794-001

The ADRF5043 has enable and logic select controls to feature all off state and port mirroring, respectively.

The ADRF5043 is pin compatible with the ADRF5042 fast switching version, which operates from 100 MHz to 44 GHz.

The ADRF5043 comes in a [24-terminal, 3 mm \$\times\$ 3 mm, RoHS compliant, land grid array \(LGA\) package](#) and can operate from -40°C to +105°C.

Rev. A

[Document Feedback](#)

Information furnished by Analog Devices is believed to be accurate and reliable. However, no responsibility is assumed by Analog Devices for its use, nor for any infringements of patents or other rights of third parties that may result from its use. Specifications subject to change without notice. No license is granted by implication or otherwise under any patent or patent rights of Analog Devices. Trademarks and registered trademarks are the property of their respective owners.

TABLE OF CONTENTS

Features	1	Pin Configuration and Function Descriptions	6
Applications	1	Interface Schematics	6
Functional Block Diagram	1	Typical Performance Characteristics	7
General Description	1	Insertion Loss, Return Loss, and Isolation	7
Revision History	2	Input Power Compression and Third-Order Intercept	9
Specifications	3	Theory of Operation	10
Absolute Maximum Ratings	5	Application Information	11
Thermal Resistance	5	Evaluation Board	11
Electrostatic Discharge (ESD) Ratings	5	Outline Dimensions	12
Power Derating Curves	5	Ordering Guide	12
ESD Caution	5		

REVISION HISTORY

2/2022—Rev. 0 to Rev. A

Changes to Table 5 and Figure 5	6
Added Figure 6; Renumbered Sequentially	6

7/2020—Revision 0: Initial Version

SPECIFICATIONS

Positive supply voltage (V_{DD}) = 3.3 V, negative supply voltage (V_{SS}) = -3.3 V, V1 pin voltage (V_1) = 0 V or 3.3 V, V2 pin voltage (V_2) = 0 V or 3.3 V, LS = 0 V or 3.3 V, EN = 0 V or 3.3 V, and T_{CASE} = 25°C on a 50 Ω system, unless otherwise noted. RFX refers to RF1 to RF4. V_{CTL} is the digital control inputs voltage.

Table 1.

Parameter	Symbol	Test Conditions/Comments	Min	Typ	Max	Unit
FREQUENCY RANGE	f		0.009		44,000	MHz
INSERTION LOSS						
Between RFC and RFX (On)		9 kHz to 18 GHz		1.5		dB
		18 GHz to 26 GHz		1.8		dB
		26 GHz to 35 GHz		2.1		dB
		35 GHz to 40 GHz		2.4		dB
		40 GHz to 44 GHz		2.5		dB
ISOLATION						
Between RFC and RFX (Off)		9 kHz to 18 GHz		44		dB
		18 GHz to 26 GHz		43		dB
		26 GHz to 35 GHz		40		dB
		35 GHz to 40 GHz		39		dB
		40 GHz to 44 GHz		36		dB
RETURN LOSS						
RFC and RFX (On)		9 kHz to 18 GHz		15		dB
		18 GHz to 26 GHz		15		dB
		26 GHz to 35 GHz		14		dB
		35 GHz to 40 GHz		13		dB
		40 GHz to 44 GHz		13		dB
RFX (Off)		9 kHz to 18 GHz		23		dB
		18 GHz to 26 GHz		20		dB
		26 GHz to 35 GHz		17		dB
		35 GHz to 40 GHz		15		dB
		40 GHz to 44 GHz		14		dB
SWITCHING						
Rise and Fall Time	t_{RISE}, t_{FALL}	10% to 90% of RF output		1.1		μ s
On and Off Time	t_{ON}, t_{OFF}	50% V_{CTL} to 90% of RF output		2.8		μ s
Settling Time						
0.1 dB		50% V_{CTL} to 0.1 dB of final RF output		6		μ s
0.05 dB		50% V_{CTL} to 0.05 dB of final RF output		7.8		μ s
INPUT LINEARITY ¹						
0.1 dB Power Compression	P0.1dB	f = 1 MHz to 40 GHz		26		dBm
1 dB Power Compression	P1dB	f = 1 MHz to 40 GHz		27		dBm
Third-Order Intercept	IP3	Two-tone input power = 15 dBm each tone, f = 1 MHz to 40 GHz, Δf = 1 MHz		48		dBm
Second-Order Intercept	IP2	Two-tone input power = 15 dBm each tone, f = 10 GHz, Δf = 1 MHz		120		dBm
VIDEO FEEDTHROUGH ²				3		mV p-p
SUPPLY CURRENT		VDD, VSS pins				
Positive Supply Current	I_{DD}			370		μ A
Negative Supply Current	I_{SS}			-100		μ A
DIGITAL CONTROL INPUTS		V1, V2, EN, LS pins				
Voltage						
Low	V_{INL}		0		0.8	V
High	V_{INH}		1.2		3.3	V

Parameter	Symbol	Test Conditions/Comments	Min	Typ	Max	Unit
Current						
Low	I_{INL}			3		μA
High	I_{INH}			6		μA
RECOMMENDED OPERATING CONDITONS						
Supply Voltage						
Positive	V_{DD}		3.15		3.45	V
Negative	V_{SS}		-3.45		-3.15	V
Digital Control Inputs Voltage	V_{CTL}		0		V_{DD}	V
RFx Input Power ³	P_{IN}	$f = 1 \text{ MHz to } 44 \text{ GHz, } T_{CASE} = 85^{\circ}C^4$				
Through Path		Average			24	dBm
		Peak			24	dBm
Terminated Path		Average			24	dBm
		Peak			24	dBm
Hot Switching		Average			24	dBm
		Peak			24	dBm
Case Temperature	T_{CASE}		-40		+105	$^{\circ}C$

¹ For input linearity performance over frequency, see Figure 19 to Figure 22.

² Video feedthrough is the spurious dc transient measured at the RF ports in a 50 Ω test setup, without an RF signal present while switching the control voltage.

³ For power derating over frequency, see Figure 2.

⁴ For 105 $^{\circ}C$ operation, the power handling degrades from the $T_{CASE} = 85^{\circ}C$ specification by 3 dB.

ABSOLUTE MAXIMUM RATINGS

For recommended operating conditions, see Table 1.

Table 2.

Parameter	Rating
Supply Voltage	
Positive	−0.3 V to +3.6 V
Negative	−3.6 V to +0.3 V
Digital Control Inputs ¹	−0.3 V to $V_{DD} + 0.3$ V or 3.3 mA, whichever occurs first
RFx Input Power ($f^2 = 1$ MHz to 44 GHz, $T_{CASE} = 85^\circ\text{C}$)	
Through Path	
Average	26 dBm
Peak	26dBm
Terminated Path	
Average	25 dBm
Peak	25dBm
Hot Switching	
Average	25 dBm
Peak	25dBm
Temperature	
Junction, T_J	135°C
Storage Range	−65°C to +150°C
Reflow	260°C

¹ Overvoltages at digital control inputs are clamped by internal diodes. Current must be limited to the maximum rating given.

² For power derating over frequency, see Figure 2.

³ For 105°C operation, the power handling degrades from the $T_{CASE} = 85^\circ\text{C}$ specification by 3 dB.

Stresses at or above those listed under Absolute Maximum Ratings may cause permanent damage to the product. This is a stress rating only; functional operation of the product at these or any other conditions above those indicated in the operational section of this specification is not implied. Operation beyond the maximum operating conditions for extended periods may affect product reliability.

THERMAL RESISTANCE

Thermal performance is directly linked to printed circuit board (PCB) design and operating environment. Careful attention to PCB thermal design is required.

θ_{JC} is the junction to case bottom (channel to package bottom) thermal resistance.

Table 3. Thermal Resistance

Package Type	θ_{JC} ¹	Unit
CC-24-12		
Through Path	468	°C/W
Terminated Path	200	°C/W

¹ θ_{JC} was determined by simulation under the following conditions: the heat transfer is due solely to thermal conduction from the channel through the ground pad to the PCB, and the ground pad is held constant at the operating temperature of 85°C.

ELECTROSTATIC DISCHARGE (ESD) RATINGS

The following ESD information is provided for handling of ESD sensitive devices in an ESD protected area only.

Human body model (HBM) per ANSI/ESDA/JEDEC JS-001.

ESD Ratings for ADRF5043

Table 4. ADRF5043, 24-Terminal LGA

ESD Model	Withstand Threshold (V)
HBM	
RFx Pins	1000
Supply and Digital Control Pins	2000

POWER DERATING CURVES

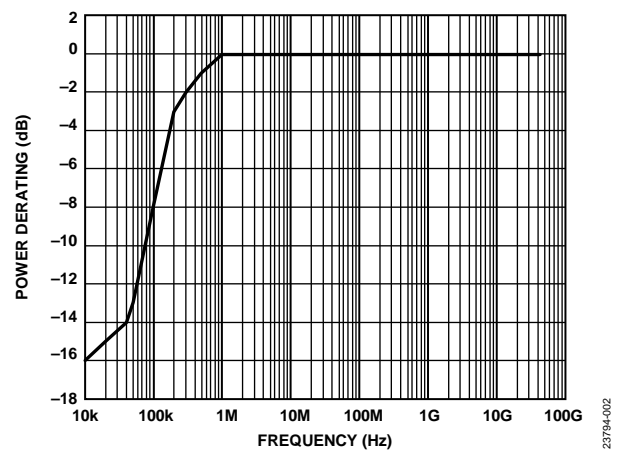

Figure 2. Power Derating vs. Frequency, Low Frequency Detail, $T_{CASE} = 85^\circ\text{C}$

ESD CAUTION



ESD (electrostatic discharge) sensitive device. Charged devices and circuit boards can discharge without detection. Although this product features patented or proprietary protection circuitry, damage may occur on devices subjected to high energy ESD. Therefore, proper ESD precautions should be taken to avoid performance degradation or loss of functionality.

PIN CONFIGURATION AND FUNCTION DESCRIPTIONS

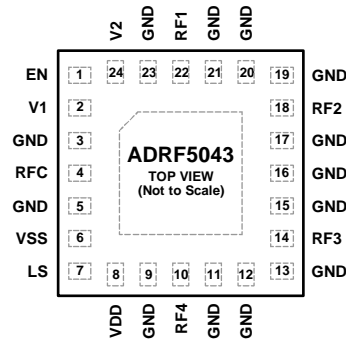

NOTES
 1. EXPOSED PAD. THE EXPOSED PAD MUST BE CONNECTED TO THE RF AND DC GROUND.

23794-004

Figure 3. Pin Configuration (Top View)

Table 5. Pin Function Descriptions

Pin No.	Mnemonic	Description
1	EN	Enable Input. This pin is internally pulled down with 100 kΩ. See Table 6 for the truth table. See Figure 6 for the interface schematic.
2	V1	Control Input 1. See Table 6 for the truth table. See Figure 5 for the interface schematic.
3, 5, 9, 11 to 13, 15 to 17, 19 to 21, 23	GND	Ground. The GND pins must be connected to the RF and dc ground of the PCB.
4	RFC	RF Common Port. RFC is dc-coupled to 0 V and ac matched to 50 Ω. No dc blocking capacitor is required when the RF line potential is equal to 0 V dc. See Figure 4 for the interface schematic.
6	VSS	Negative Supply Voltage.
7	LS	Logic Select Input. This pin is internally pulled down with 100 kΩ. See Table 6 for the truth table. See Figure 6 for the interface schematic.
8	VDD	Positive Supply Voltage.
10	RF4	RF Throw Port 4. RF4 is dc-coupled to 0 V and ac matched to 50 Ω. No dc blocking capacitor is required when the RF line potential is equal to 0 V dc. See Figure 4 for the interface schematic.
14	RF3	RF Throw Port 3. RF3 is dc-coupled to 0 V and ac matched to 50 Ω. No dc blocking capacitor is required when the RF line potential is equal to 0 V dc. See Figure 4 for the interface schematic.
18	RF2	RF Throw Port 2. RF2 is dc-coupled to 0 V and ac matched to 50 Ω. No dc blocking capacitor is required when the RF line potential is equal to 0 V dc. See Figure 4 for the interface schematic.
22	RF1	RF Throw Port 1. RF1 is dc-coupled to 0 V and ac matched to 50 Ω. No dc blocking capacitor is required when the RF line potential is equal to 0 V dc. See Figure 4 for the interface schematic.
24	V2	Control Input 2. See Table 6 for the truth table. See Figure 5 for the interface schematic.
	EPAD	Exposed Pad. The exposed pad must be connected to the RF and dc ground.

INTERFACE SCHEMATICS

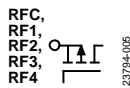

Figure 4. RFC and RF1 to RF4 Interface Schematic

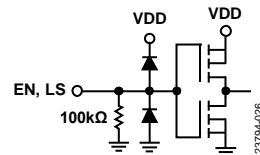

Figure 6. EN and LS Interface Schematic

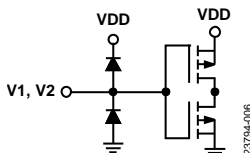

Figure 5. V1 and V2 Interface Schematic

TYPICAL PERFORMANCE CHARACTERISTICS

INSERTION LOSS, RETURN LOSS, AND ISOLATION

$V_{DD} = 3.3\text{ V}$, $V_{SS} = -3.3\text{ V}$, $V_{CTL} = 0\text{ V}$ or 3.3 V , and $T_{CASE} = 25^\circ\text{C}$ on a $50\ \Omega$ system, unless otherwise noted. Measured on the evaluation board.

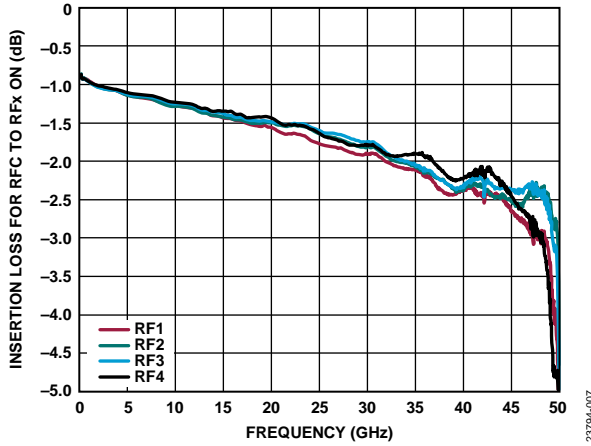

Figure 7. Insertion Loss for RFC to RFX On vs. Frequency

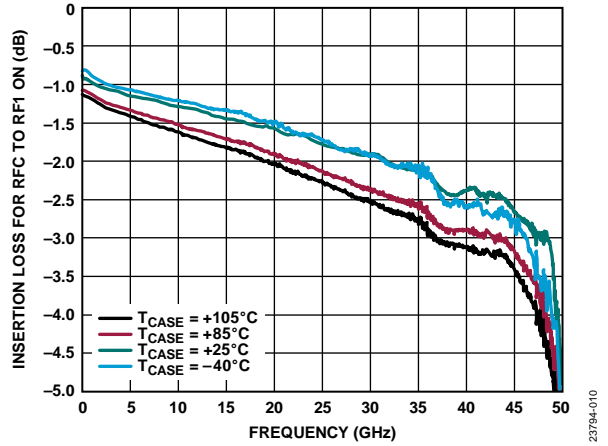

Figure 10. Insertion Loss for RFC to RF1 On vs. Frequency over Various Temperatures

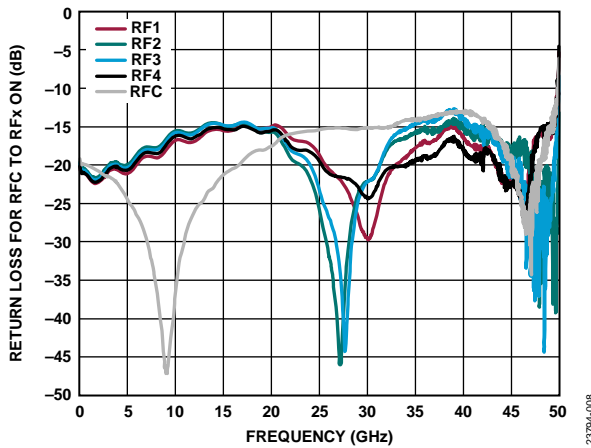

Figure 8. Return Loss for RFC and RFX On vs. Frequency

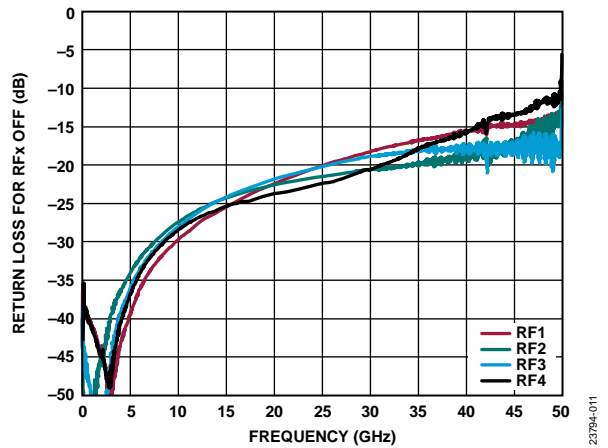

Figure 11. Return Loss for RFX Off vs. Frequency

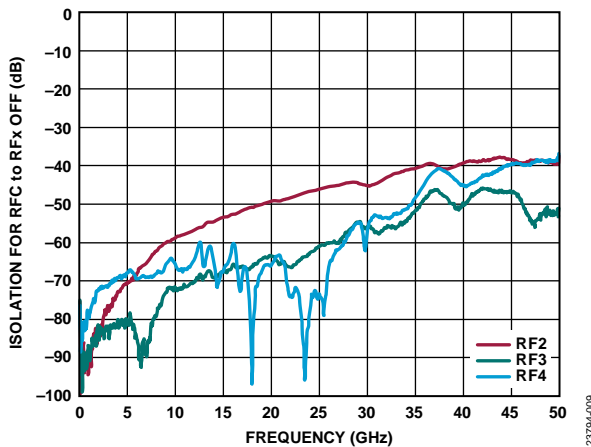

Figure 9. Isolation for RFC to RFX Off vs. Frequency, RFC to RF1 Path On

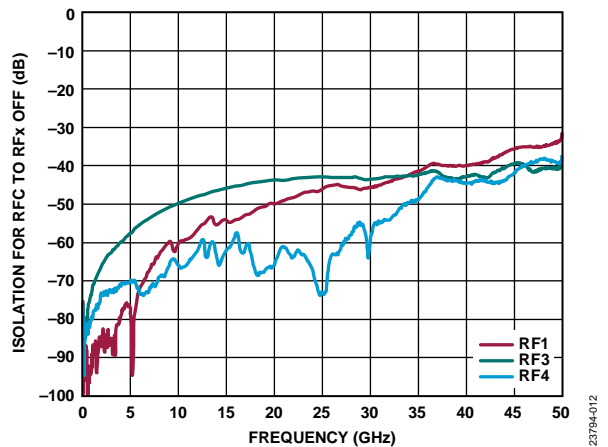

Figure 12. Isolation for RFC to RFX Off vs. Frequency, RFC to RF2 Path On

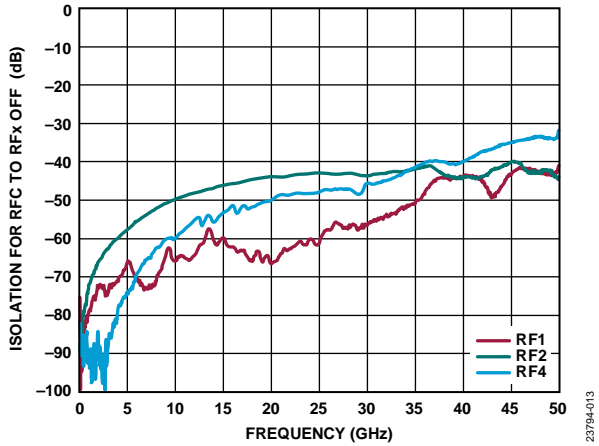

Figure 13. Isolation for RFC to RFX Off vs. Frequency, RFC to RF3 Path On

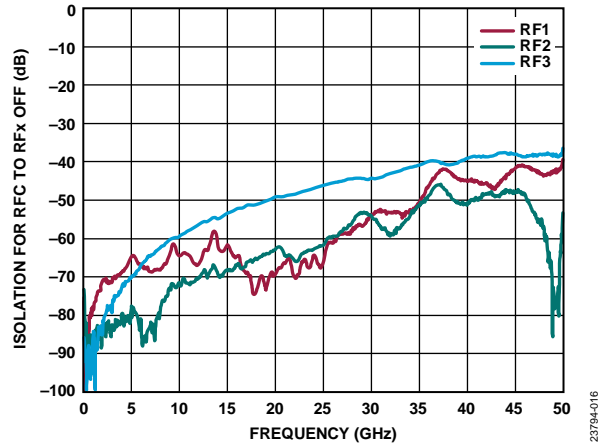

Figure 16. Isolation for RFC to RFX Off vs. Frequency, RFC to RF4 Path On

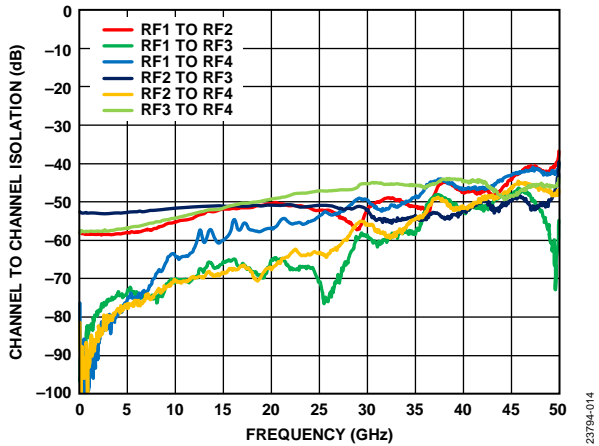

Figure 14. Channel to Channel Isolation vs. Frequency, RFC to RF1 Path On

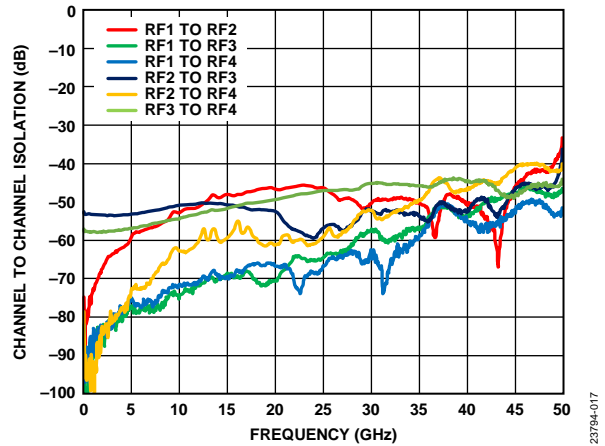

Figure 17. Channel to Channel Isolation vs. Frequency, RFC to RF2 Path On

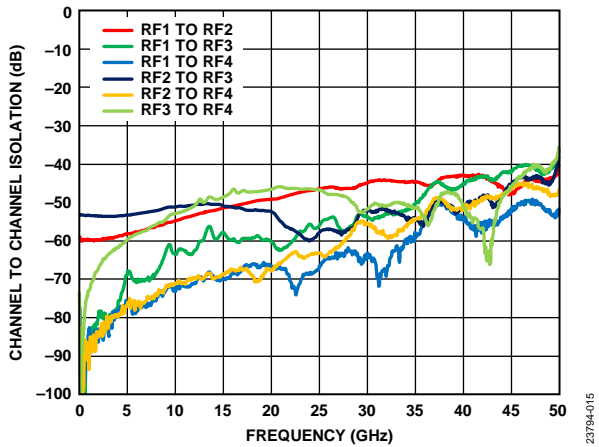

Figure 15. Channel to Channel Isolation vs. Frequency, RFC to RF3 Path On

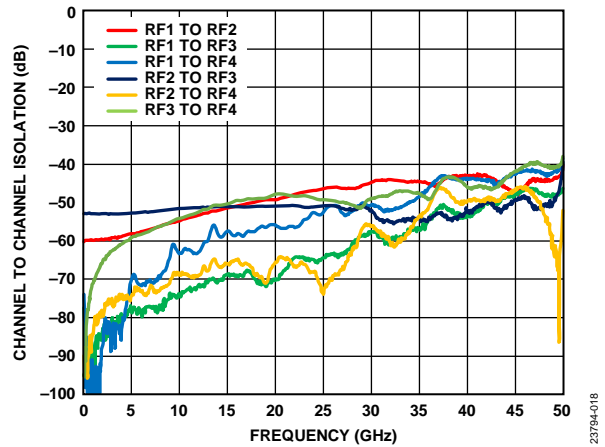

Figure 18. Channel to Channel Isolation vs. Frequency, RFC to RF4 Path On

INPUT POWER COMPRESSION AND THIRD-ORDER INTERCEPT

$V_{DD} = +3.3\text{ V}$, $V_{SS} = -3.3\text{ V}$, $V_{CTL} = 0\text{ V}$ or $+3.3\text{ V}$, and $T_{CASE} = 25^\circ\text{C}$ on a $50\ \Omega$ system, unless otherwise noted. Measured on the evaluation board.

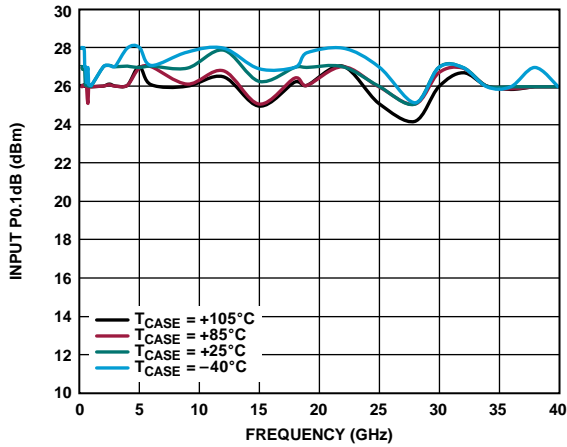

Figure 19. Input P0.1dB vs. Frequency over Various Temperatures

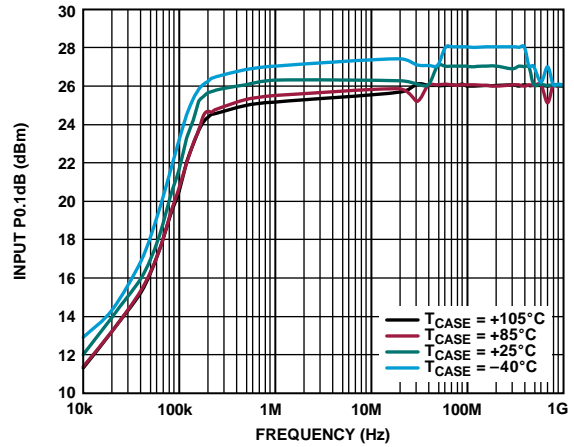

Figure 21. Input P0.1dB vs. Frequency, Low Frequency Detail over Various Temperatures

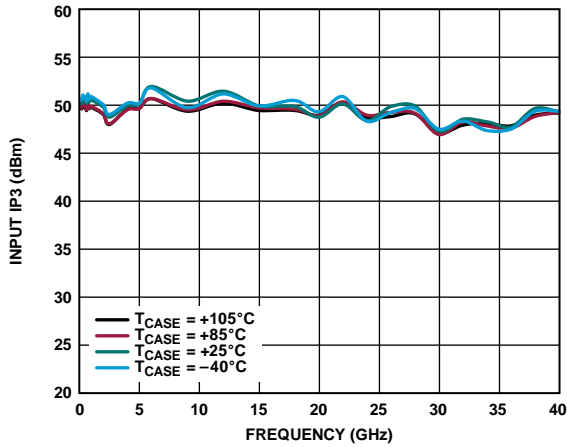

Figure 20. Input IP3 vs. Frequency over Various Temperatures

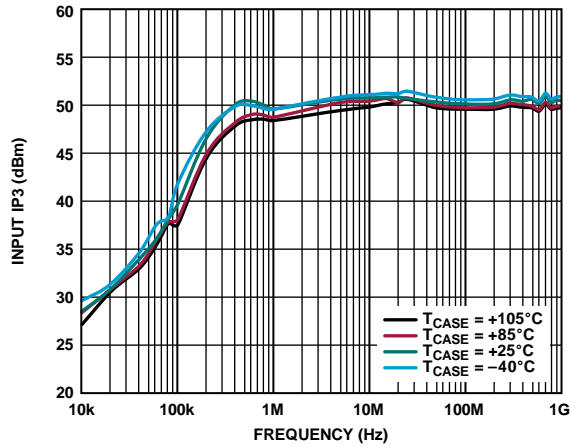

Figure 22. Input IP3 vs. Frequency, Low Frequency Detail over Various Temperatures

THEORY OF OPERATION

The ADRF5043 requires a positive supply voltage applied to the VDD pin and a negative supply voltage applied to the VSS pin. Bypassing capacitors are recommended on the supply lines to minimize RF coupling.

All of the RF ports (RFC, RF1 to RF4) are dc-coupled to 0 V, and no dc blocking is required at the RF ports when the RF line potential is equal to 0 V. The RF ports are internally matched to 50 Ω. Therefore, external matching networks are not required.

The ADRF5043 integrates a driver to perform logic functions internally and to provide the user with the advantage of a simplified CMOS-/LVTTTL-compatible control interface. The driver features four digital control input pins (EN, LS, V1, and V2) that control the state of the RFx paths (see Table 6).

The logic select input (LS) allows the user to define the control input logic sequence for the RF path selections. The logic level applied to the V1 and V2 pins determines which RFx port is in the insertion loss state while the other three paths are in the isolation state.

When the EN pin is logic high, all four RFx paths are in isolation state regardless of the logic state of LS, V1, V2. RFx ports are terminated to internal 50 Ω resistors, and RFC becomes reflective.

The insertion loss path conducts the RF signal between the selected RF throw port and the RF common port. The switch design is bidirectional with equal power handling capabilities. The RF input signal can be applied to the RFC port or the selected RF throw port. The isolation paths provide high loss between the insertion loss path and the unselected RF throw ports that are terminated to internal 50 Ω resistors.

The ideal power-up sequence is as follows:

1. Connect GND to ground.
2. Power up VDD and VSS. Powering up VSS after VDD avoids current transients on VDD during ramp up.
3. Apply a control voltage to the digital control inputs (EN, LS, V1, and V2). Applying a control voltage to the digital control inputs before the VDD supply can inadvertently forward bias and damage the internal ESD protection structures. Use a series 1 kΩ resistor to limit the current flowing into the control pin in such cases. If the control pins are not driven to a valid logic state (that is, controller output is in high impedance state) after VDD is powered up, it is recommended to use a pull-up or pull-down resistor.
4. Apply an RF input signal.

The ideal power-down sequence is the reverse order of the power-up sequence.

Table 6. Control Voltage Truth Table

Digital Control Inputs				RFx Paths			
EN	LS	V1	V2	RFC to RF1	RFC to RF2	RFC to RF3	RFC to RF4
Low	Low	Low	Low	Insertion loss (on)	Isolation (off)	Isolation (off)	Isolation (off)
Low	Low	High	Low	Isolation (off)	Insertion loss (on)	Isolation (off)	Isolation (off)
Low	Low	Low	High	Isolation (off)	Isolation (off)	Insertion loss (on)	Isolation (off)
Low	Low	High	High	Isolation (off)	Isolation (off)	Isolation (off)	Insertion loss (on)
Low	High	Low	Low	Isolation (off)	Isolation (off)	Isolation (off)	Insertion loss (on)
Low	High	High	Low	Isolation (off)	Isolation (off)	Insertion loss (on)	Isolation (off)
Low	High	Low	High	Isolation (off)	Insertion loss (on)	Isolation (off)	Isolation (off)
Low	High	High	High	Insertion loss (on)	Isolation (off)	Isolation (off)	Isolation (off)
High	Low or high	Low or high	Low or high	Isolation (off)	Isolation (off)	Isolation (off)	Isolation (off)

APPLICATION INFORMATION

EVALUATION BOARD

All measurements in this data sheet are measured on the [ADRF5043-EVALZ](#) evaluation board. Figure 25 shows the simplified application circuit for ADRF5043-EVALZ evaluation board. See the ADRF5043-EVALZ user guide for more information on using the evaluation board.

The design of the ADRF5043-EVALZ board serves as a layout recommendation. The Gerber files of the ADRF5043-EVALZ evaluation board are available at www.analog.com/EVAL-ADRF5043.

The ADRF5043-EVALZ is a 4-layer evaluation board. The outer copper (Cu) layers are 0.5 oz (0.7 mil) plated to 1.5 oz (2.2 mil) and are separated by dielectric materials. Figure 23 shows the cross sectional view of the evaluation board startup.



Figure 23. Evaluation Board Cross Sectional View

All RF traces are routed on the top copper layer, whereas the inner and bottom layers are grounded planes that provide a solid ground for the RF transmission lines. The top dielectric material is 8 mil Rogers RO4003, offering optimal high frequency performance. The middle and bottom dielectric materials provide mechanical strength. The total board thickness is 62 mil, which allows 2.4 mm RF launchers to be connected at the board edges.

The RF transmission lines were designed using a coplanar waveguide (CPWG) model, with a trace width of 14 mil and a ground clearance of 7 mil to have a characteristic impedance of 50 Ω. The RF transmission lines are tapered at the RFC or RFx pin transition, as shown in Figure 24. For optimal RF and thermal grounding, arrange as many plated through vias as possible around the transmission lines and under the exposed pad of the package.

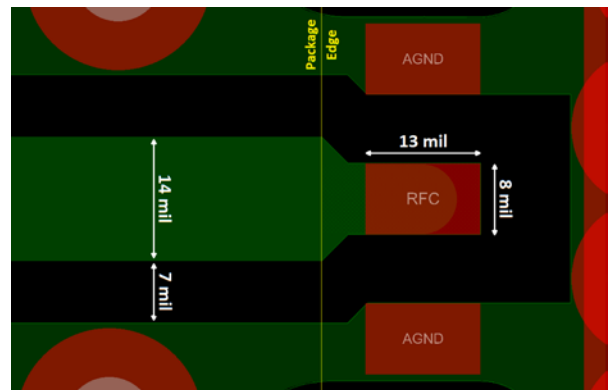

Figure 24. RF Transmission Lines

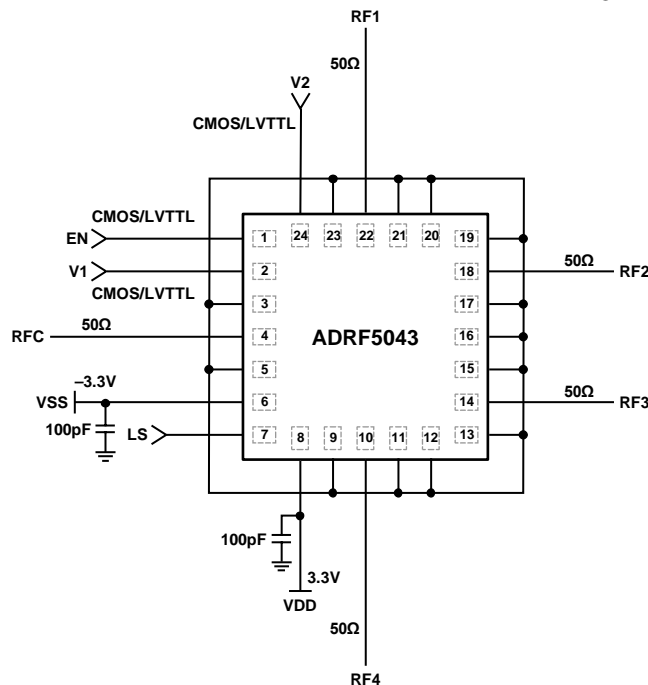

Figure 25. Application Circuit