

FEATURES

- Matched pair of programmable filters and triple VGAs**
- Continuous gain control range: 72 dB**
- Digital gain control: 30 dB**
- Filter bypass mode bandwidth**
 - ± 1 dB gain flatness: 300 MHz
 - 3 dB small signal bandwidth: 650 MHz/1.1 GHz, VGA2 and VGA3 21 dB/12 dB, respectively
- 6-pole Butterworth filter: 1 MHz to 63 MHz**
 - in 1 MHz steps, 0.5 dB corner frequency
- Peak detector**
- IMD3: >65 dBc for 1.5 V p-p composite output**
- HD2, HD3: >65 dBc for 1.5 V p-p output**
- Differential input and output**
- Flexible output and input common-mode ranges**
- Optional dc output offset correction**
- SPI programmable filter corners and gain steps**
- Single 3.3 V supply operation with power-down feature**

APPLICATIONS

- Point-to-point and point-to-multipoint radios**
- Baseband IQ receivers**
- Diversity receivers**
- ADC drivers**
- Instrumentation**
- Medical**

GENERAL DESCRIPTION

The **ADRF6518** is a matched pair of fully differential low noise and low distortion programmable filters and variable gain amplifiers (VGAs). Each channel is capable of rejecting large out-of-band interferers while reliably boosting the wanted signal, thus reducing the bandwidth and resolution requirements on the analog-to-digital converters (ADCs). The excellent matching between channels and their high spurious-free dynamic range over all gain and bandwidth settings make the **ADRF6518** ideal for quadrature-based (IQ) communication systems with dense constellations, multiple carriers, and nearby interferers. The various amplifier gains, filter corners, and other features are all programmable via a serial port interface (SPI) port.

The first VGA that precedes the filters offers 24 dB of continuous gain control with fixed gain options of 9 dB, 12 dB, and 15 dB, and sets a differential input impedance of 400 Ω . The filters provide a six-pole Butterworth response with 0.5 dB corner frequencies from 1 MHz to 63 MHz in 1 MHz steps. For operation beyond 63 MHz, the filter can be disabled and completely bypassed, thereby extending the -3 dB bandwidth (BW) up to 1.1 GHz.

Rev. A

Information furnished by Analog Devices is believed to be accurate and reliable. However, no responsibility is assumed by Analog Devices for its use, nor for any infringements of patents or other rights of third parties that may result from its use. Specifications subject to change without notice. No license is granted by implication or otherwise under any patent or patent rights of Analog Devices. Trademarks and registered trademarks are the property of their respective owners.

Document Feedback

FUNCTIONAL BLOCK DIAGRAM

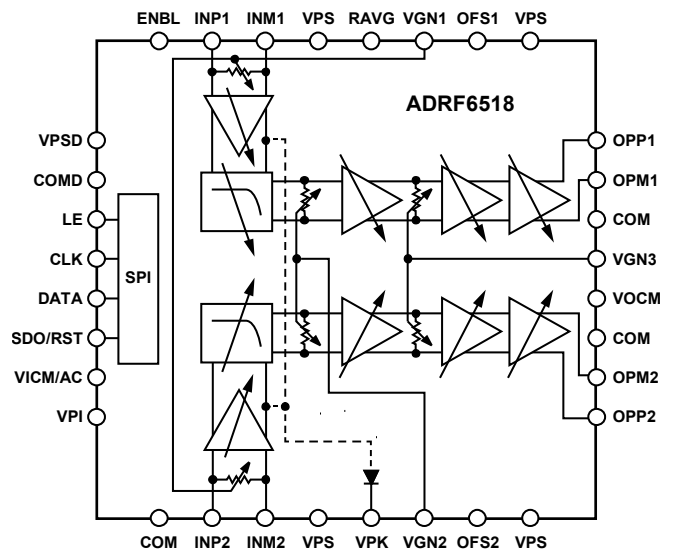

Figure 1

A wideband peak detector is available to monitor the peak signal at the filter inputs. The pair of VGAs that follow the filters each provides 24 dB of continuous gain control with fixed gain options of 12 dB, 15 dB, 18 dB, and 21 dB. The output buffers offer an additional option of 3 dB or 9 dB gain and provide a differential output impedance of less than 10 Ω . They are capable of driving 1.5 V p-p into 400 Ω loads at better than 65 dBc HD3. The output common-mode voltage defaults to VPS/2 and can be adjusted down to 900 mV via the VOVM pin. Independent, built-in dc offset correction loops for each channel can be disabled via the SPI if fully dc-coupled operation is desired. The high-pass corner frequency is determined by external capacitors on the OFS1 and OFS2 pins and the postfilter VGA gain.

The **ADRF6518** operates from a 3.15 V to 3.45 V supply and consumes a maximum supply current of 400 mA. When fully disabled, it consumes <1 mA. The **ADRF6518** is fabricated in an advanced silicon-germanium BiCMOS process and is available in a 32-lead, exposed pad LFCSP. Performance is specified over the -40°C to +85°C temperature range.

TABLE OF CONTENTS

Features	1	Key Parameters for Quadrature-Based Receivers	25
Applications	1	Applications Information	26
Functional Block Diagram	1	Basic Connections	26
General Description	1	Supply Decoupling	26
Revision History	2	Input Signal Path	26
Specifications	3	Output Signal Path	26
Timing Diagrams	5	DC Offset Compensation Loop Enabled	26
Absolute Maximum Ratings	6	Common-Mode Bypassing	27
ESD Caution	6	Serial Port Connections	27
Pin Configuration and Function Descriptions	7	Enable/Disable Function	27
Typical Performance Characteristics	8	Gain Pin Decoupling	27
Filter Mode	8	Peak Detector Connections	27
Bypass Mode	16	Error Vector Magnitude (EVM) Performance	27
Mixed Power and Filter Modes	18	EVM Test Setup	27
Characterization	19	EVM Measurement	27
Noise Figure Calculation	19	EVM System Measurement	29
Register Map and Codes	20	Effect of Filter BW on EVM	31
Theory of Operation	21	Pull-Down Resistors for Disable Function	31
Input VGAs	21	Instability at High Gain in Filter Bypass Mode	31
Peak Detector	22	Instability at Low Filter Corners and Low Power Mode	32
Programmable Filters	22	Peak Detector Bandwidth And Slew Rate	32
Variable Gain Amplifiers (VGAs)	23	Linear Operation of the ADRF6518	32
Output Buffers/ADC Drivers	23	Evaluation Board	33
DC Offset Compensation Loop	23	Evaluation Board Control Software	33
Programming the ADRF6518	23	Schematics and Artwork	34
Noise Characteristics	24	Outline Dimensions	39
Distortion Characteristics	24	Ordering Guide	39
Maximizing the Dynamic Range	25		

REVISION HISTORY

12/2017—Rev. 0 to Rev. A

Changed 1100 MHz to 1.1 GHz	Throughout
Change to Product Title	1
Changes to Figure 1	1
Changes to Table 1	3
Changes to Figure 3	5
Changes to Figure 12	9
Changes to Figure 20	10
Reorganized Typical Performance Characteristics Section; Renumbered Sequentially	10
Changes to Figure 49 Caption, Figure 51 Caption, and Figure 52 Caption	15

Changes to Figure 56	16
Changes to Figure 69 and Figure 69 Caption	22
Changes to Figure 72	26
Changes to Figure 73 and Figure 74	28
Added Figure 86 and Figure 87; Renumbered Sequentially	32
Added Instability at Low Filter Corners and Low Power Mode Section, and Peak Detector Bandwidth and Slew Rate Section	32
Changes to Figure 88	32
Changes to Figure 89	33

6/2013—Revision 0: Initial Version

SPECIFICATIONS

VPS, VPI, VPSD = 3.3 V, T_A = 25°C, Z_{LOAD} = 400 Ω, power mode bit (B9) = 0 (low power mode), digital gain code bits (B8 to B2) = 0000001, and dc offset disable bit (B1) = 0 (enabled), unless otherwise noted.

Table 1.

Parameter	Test Conditions/Comments	Min	Typ	Max	Unit
FREQUENCY RESPONSE, FILTER BYPASS MODE					
±1 dB Gain Flatness Bandwidth			300		MHz
−3 dB Small Signal Bandwidth	VGA2 and VGA3 21 dB digital gain setting		650		MHz
	VGA2 and VGA3 12 dB digital gain setting		1100		MHz
FREQUENCY RESPONSE					
Low-Pass Corner Frequency, f _c	Six-pole Butterworth filter, 0.5 dB bandwidth	1		63	MHz
Step Size			1		MHz
Corner Frequency Absolute Accuracy	Over operating temperature range		±8		% f _c
Corner Frequency Matching	Channel A and Channel B at same gain and bandwidth settings		±0.5		% f _c
Pass-Band Ripple			0.5		dB p-p
Gain Matching	Channel A and Channel B at same gain and bandwidth settings		±0.1		dB
Group Delay Variation	From midband to peak				
Corner Frequency = 1 MHz			135		ns
Corner Frequency = 30 MHz			11		ns
Group Delay Matching	Channel A and Channel B at same gain				
Corner Frequency = 1 MHz			5		ns
Corner Frequency = 30 MHz			0.2		ns
Stop-Band Rejection					
Relative to Pass Band	2 × f _c		30		dB
	5 × f _c		75		dB
INPUT STAGE					
Maximum Input Swing	INP1, INM1, INP2, INM2, VICM/AC At minimum gain, VGN1 = 0 V		5.0		V p-p
Differential Input Impedance			400		Ω
Input Common-Mode Range, DC-Coupled Mode	1.5 V p-p input voltage, HD3 > 65 dBc (VPI = 3.3 V), VICM/AC floating or logic high	1.35		1.95	V
	1.5 V p-p input voltage, HD3 > 65 dBc (VPI = 5.0 V), VICM/AC floating or logic high	1.35		3.1	V
Input Common-Mode, AC-Coupled Mode	VPI = 3.3 V to 5.0 V, VICM/AC = 0 V		VPS/2		V
VICM/AC Input Impedance			7.75		kΩ
PEAK DETECTOR					
Output Scaling	VPK, RAVG, SDO/RST Relative to differential peak voltage at filter input		1		V/V peak
Reset Threshold	Logic high duration > 25 ns		>2.0		V
GAIN CONTROL					
Gain Range	VGN1, VGN2, VGN3 Maximum digital gains	−6		+66	dB
	Minimum digital gains	−36		+36	dB
Voltage Attenuation Range	Each attenuator; V _{GAIN} from 0 V to 1 V	−24		0	dB
Gain Slope			30		mV/dB
Gain Error	V _{GAIN} from 300 mV to 800 mV		0.2		dB

Parameter	Test Conditions/Comments	Min	Typ	Max	Unit
OUTPUT STAGE	OPP1, OPM1, OPP2, OPM2, VOVM				
Maximum Output Swing	At maximum gain, $R_{LOAD} = 400 \Omega$ HD2 > 65 dBc, HD3 > 65 dBc, $R_{LOAD} = 400 \Omega$		3 1.5		V p-p V p-p
Differential Output Impedance			<10		Ω
Output DC Offset	Inputs shorted, offset loop enabled		<20		mV
Output Common-Mode Range	1.5 V p-p output voltage VOVM left floating	0.9		VPS – 1.2	V V
VOVM Input Impedance			VPS/2 23		k Ω
NOISE/DISTORTION					
Corner Frequency = 63 MHz					
Output Noise Density	Minimum gain at $f_c/2$ Maximum gain at $f_c/2$		–104.6 –104.3		dBV/Hz dBV/Hz
Second Harmonic, HD2	16 MHz fundamental, 1.5 V p-p Output Level Gain = 6 dB Gain = 54 dB		65 65		dBc dBc
Third Harmonic, HD3	16 MHz fundamental, 1.5 V p-p Output Level Gain = 6 dB Gain = 54 dB		82 81		dBc dBc
IMD3	30 MHz and 31 MHz tones, 1.5 V p-p output level Gain = 0 dB Gain = 30 dB Gain = 60 dB		60 80 80		dBc dBc dBc
DIGITAL LOGIC	LE, CLK, DATA, SDO				
Input High Voltage, V_{HIGH}			>2		V
Input Low Voltage, V_{LOW}			<0.8		V
Input Current, I_{HIGH}/I_{LOW}			<1		μ A
Input Capacitance, C_{IN}			2		pF
SPI TIMING	LE, CLK, DATA, SDO				
f_{CLK}	$1/t_{CLK}$		20		MHz
t_{DH}	DATA hold time		5		ns
t_{DS}	DATA setup time		5		ns
t_{LH}	LE hold time		5		ns
t_{LS}	LE setup time		5		ns
t_{PW}	CLK high pulse width		5		ns
t_D	CLK to SDO delay		5		ns
POWER AND ENABLE	VPS, VPSD, COM, COMD, ENBL				
Supply Voltage Range		3.15	3.3	3.45	V
Total Supply Current	ENBL = 3.3 V Maximum BW setting, high power filter Minimum BW setting, low power filter Filter bypassed, high power mode Filter bypassed, low power mode		400 360 260 230		mA mA mA mA
Disable Current	ENBL = 0 V, with pull-down resistors on output		1		mA
Disable Threshold			1.6		V
Enable Response Time	Delay following ENBL low-to-high transition		20		μ s
Disable Response Time	Delay following ENBL high-to-low transition		300		ns

TIMING DIAGRAMS

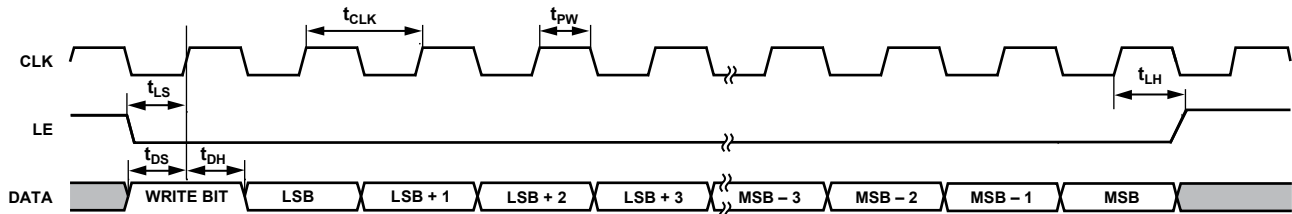

NOTES

1. THE FIRST DATA BIT DETERMINES WHETHER THE PART IS WRITING TO OR READING FROM THE INTERNAL 16-BIT REGISTER. FOR A WRITE OPERATION, THE FIRST BIT SHOULD BE A LOGIC 1. THE 16-BIT WORD IS THEN REGISTERED INTO THE DATA PIN ON CONSECUTIVE RISING EDGES OF THE CLOCK.

11449-002

Figure 2. Write Mode Timing Diagram

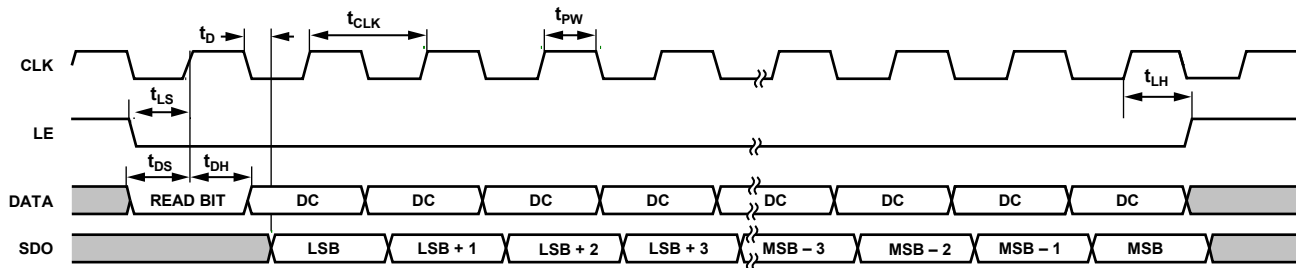

NOTES

1. THE FIRST BIT DETERMINES WHETHER THE PART IS WRITING TO OR READING FROM THE INTERNAL 16-BIT REGISTER. FOR A READ OPERATION, THE FIRST BIT SHOULD BE A LOGIC 0 ON THE DATA LINE. t_D SECONDS AFTER THE NEXT FALLING EDGE OF THE CLOCK, DATA ON THE SDO LINE BECOMES VALID AND IS CLOCKED OUT ON THE CONSECUTIVE RISING EDGES OF THE CLOCK

11449-003

Figure 3. Read Mode Timing Diagram

ABSOLUTE MAXIMUM RATINGS

Table 2.

Parameter	Rating
Supply Voltages, VPS, VPSD	3.45 V
VPI	5.25 V
ENBL, LE, CLK, DATA, SDO	VPSD + 0.5 V
INP1, INM1, INP2, INM2, VICM	VPS + 0.5 V
OPP1, OPM1, OPP2, OPM2, VOVM	VPS + 0.5 V
OFS1, OFS2, VPK, RAVG	VPS + 0.5 V
VGN1, VGN2, VGN3	VPS + 0.5 V
Internal Power Dissipation	1.25 W
θ_{JA} (Exposed Pad Soldered to Board)	37.4°C/W
Maximum Junction Temperature	150°C
Operating Temperature Range	-40°C to +85°C
Storage Temperature Range	-65°C to +150°C
Lead Temperature (Soldering 60 sec)	300°C

Stresses at or above those listed under Absolute Maximum Ratings may cause permanent damage to the product. This is a stress rating only; functional operation of the product at these or any other conditions above those indicated in the operational section of this specification is not implied. Operation beyond the maximum operating conditions for extended periods may affect product reliability.

ESD CAUTION



ESD (electrostatic discharge) sensitive device. Charged devices and circuit boards can discharge without detection. Although this product features patented or proprietary protection circuitry, damage may occur on devices subjected to high energy ESD. Therefore, proper ESD precautions should be taken to avoid performance degradation or loss of functionality.

PIN CONFIGURATION AND FUNCTION DESCRIPTIONS

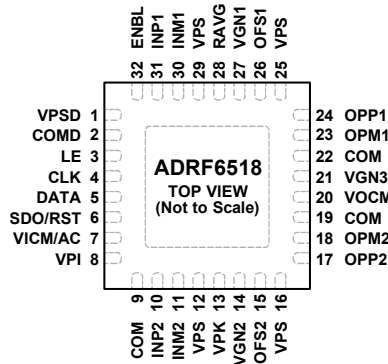

NOTES
 1. CONNECT THE EXPOSED PADDLE TO A LOW IMPEDANCE GROUND PAD.

1149-004

Figure 4. Pin Configuration

Table 3. Pin Function Descriptions

Pin No.	Mnemonic	Description
1	VPSD	Digital Positive Supply Voltage: 3.15 V to 3.45 V.
2	COMD	Digital Common. Connect this pin to an external circuit common using the lowest possible impedance.
3	LE	Latch Enable. SPI programming pin. TTL levels: $V_{LOW} < 0.8 V$, $V_{HIGH} > 2 V$.
4	CLK	SPI Port Clock. TTL levels: $V_{LOW} < 0.8 V$, $V_{HIGH} > 2 V$.
5	DATA	SPI Data Input. TTL levels: $V_{LOW} < 0.8 V$, $V_{HIGH} > 2 V$.
6	SDO/RST	SPI Data Output (SDO). TTL levels: $V_{LOW} < 0.8 V$, $V_{HIGH} > 2 V$. Peak Detector Reset (RST). A >25 ns high pulse is required on this pin to reset the detector.
7	VICM/AC	Input Common-Mode Reference (VICM). VPI/2 reference output for optimal common-mode level to drive the differential inputs. If this pin is used as a common-mode reference for the common-mode output of the previous stage, only connect high impedance nodes to this pin. AC Coupling/Internal Bias Activation (AC). Pull this pin low for ac coupling of the inputs.
8	VPI	Input Stage Supply Voltage: 3.15 V to 5.25 V. Connect VPI to VPS if the input common-mode range is narrow (1.35 V to 1.95 V). Connect VPI to 5 V if a common-mode input up to 3.1 V is desired.
9, 19, 22	COM	Analog Common. Connect COM to an external circuit common using the lowest possible impedance.
10, 11, 30, 31	INP2, INM2, INM1, INP1	Differential Inputs, 400 Ω Differential Input Impedance.
12, 16, 25, 29	VPS	Analog Positive Supply Voltage: 3.15 V to 3.45 V.
13	VPK	Peak Detector Output. Scaling of 1 V/V peak differential at filter inputs is performed, and the bigger peak of two channels is reported.
14, 21, 27	VGN2, VGN3, VGN1	VGA1, VGA2, and VGA3 Analog Gain Control. 0 V to 1 V, 30 mV/dB gain scaling.
15, 26	OFS2, OFS1	Offset Correction Loop Compensation Capacitors. Connect capacitors to a circuit common.
17, 18, 23, 24	OPP2, OPM2, OPM1, OPP1	Differential Outputs. These outputs have a $<10 \Omega$ output impedance. Common-mode range is 0.9 V to $VPS - 1.2 V$; default is $VPS/2$.
20	VOCM	Output Common-Mode Setpoint. VOCM defaults to $VPS/2$ if left open.
28	RAVG	Peak Detector Time-Constant Resistor. Connect this pin to VPS. Leave this pin open for the longest hold time. The RAVG range is ∞ to 1 k Ω .
32	ENBL	Chip Enable. Pull this pin high to enable the chip.
	EP	Exposed Ground Pad. Connect the exposed pad to a low impedance ground pad.

TYPICAL PERFORMANCE CHARACTERISTICS

FILTER MODE

VPS, VPI, VPSD = 3.3 V, $T_A = 25^\circ\text{C}$, $Z_{\text{LOAD}} = 400 \Omega$, power mode bit (B9) = 0 (low power mode), digital gain code bits (B8 to B2) = 1111110, dc offset disable bit (B1) = 0 (enabled), filter corner = 63 MHz, ac coupling mode, fundamental at 31 MHz, unless otherwise noted. For HD2/HD3 vs. gain plots: 1.5 V p-p output target level, and reference Figure 67 for analog gain distribution.

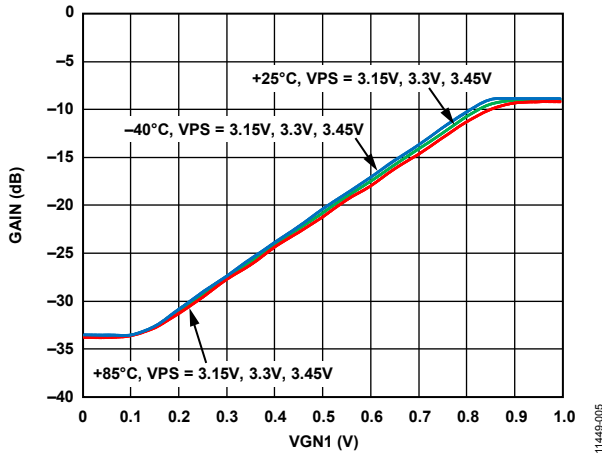

Figure 5. In-Band Gain vs. VGN1 over Supply and Temperature

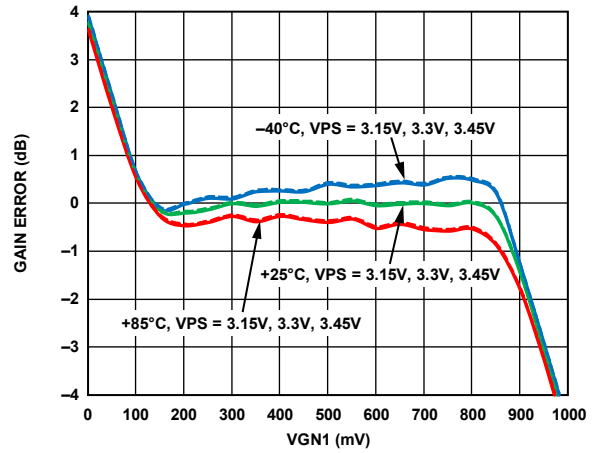

Figure 8. Gain Error vs. VGN1 over Supply and Temperature

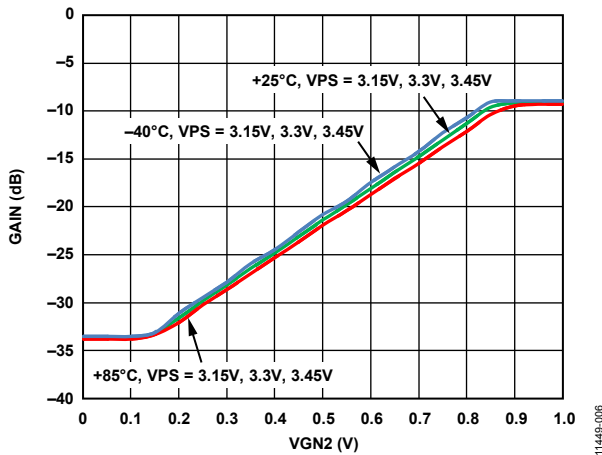

Figure 6. In-Band Gain vs. VGN2 over Supply and Temperature

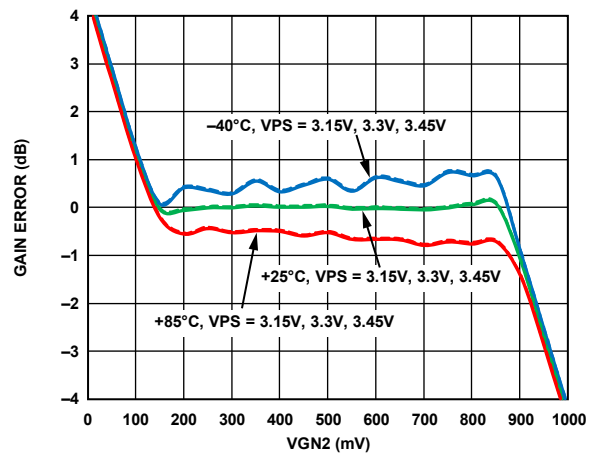

Figure 9. Gain Error vs. VGN2 over Supply and Temperature

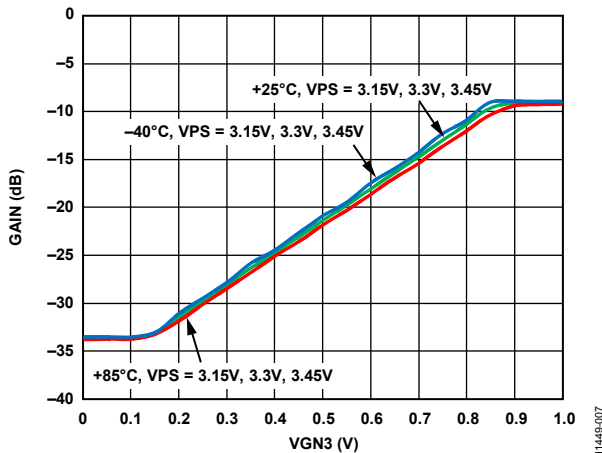

Figure 7. In-Band Gain vs. VGN3 over Supply and Temperature

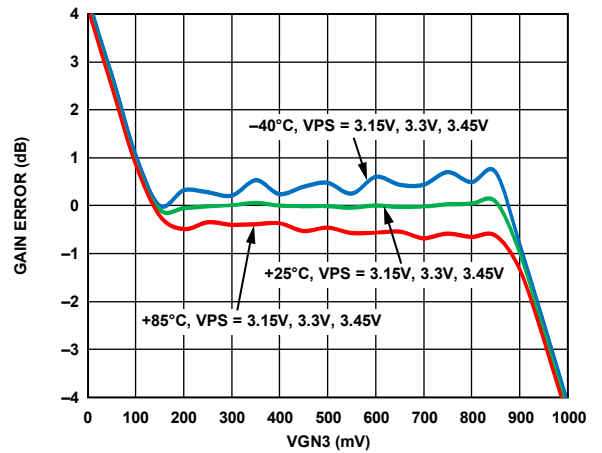

Figure 10. Gain Error vs. VGN3 over Supply and Temperature

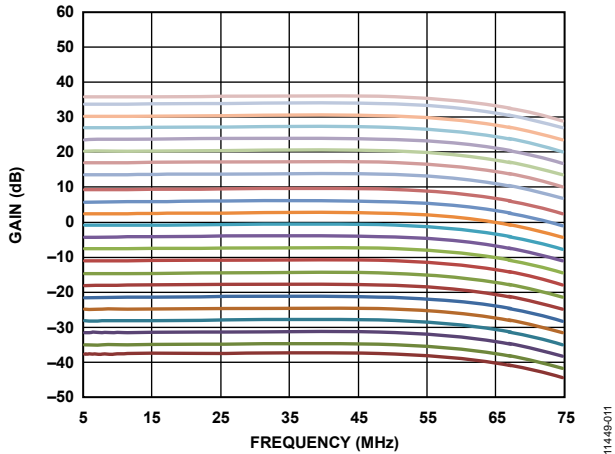

Figure 11. Gain vs. Frequency over VGN1/VGN2/VGN3

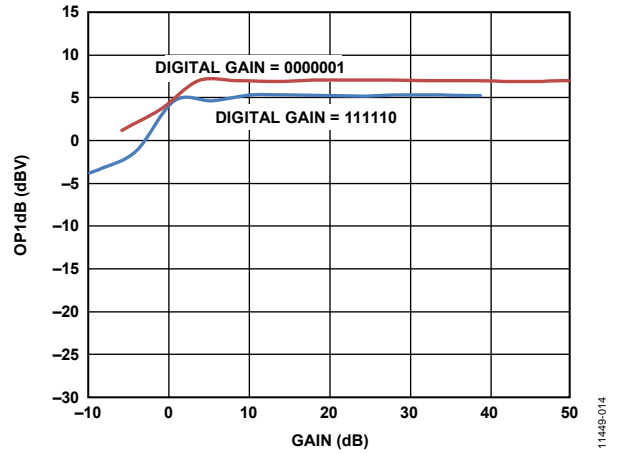

Figure 14. OP1dB vs. Gain at a Fundamental of 16 MHz

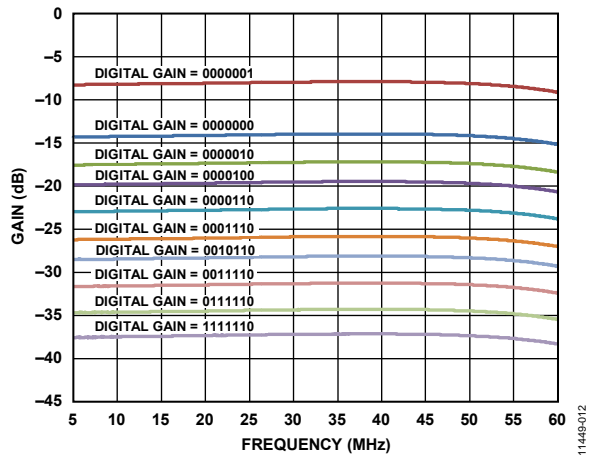

Figure 12. Digital Gain vs. Frequency; VGN1/VGN2/VGN3 = 0 V

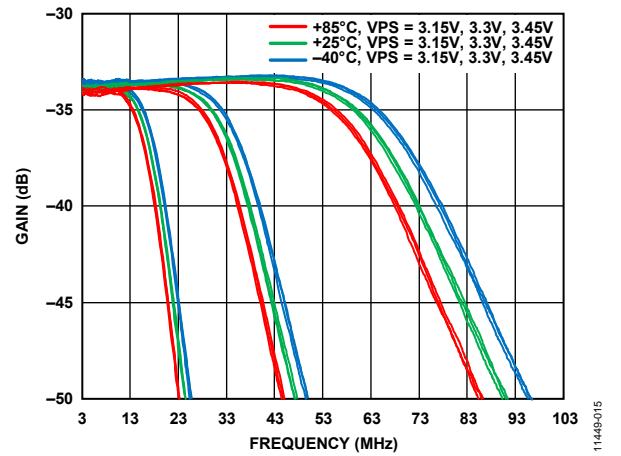

Figure 15. Frequency Response over Supply and Temperature; VGN1/VGN2/VGN3 = 0 V, Filter Corners = 15 MHz, 30 MHz, and 60 MHz

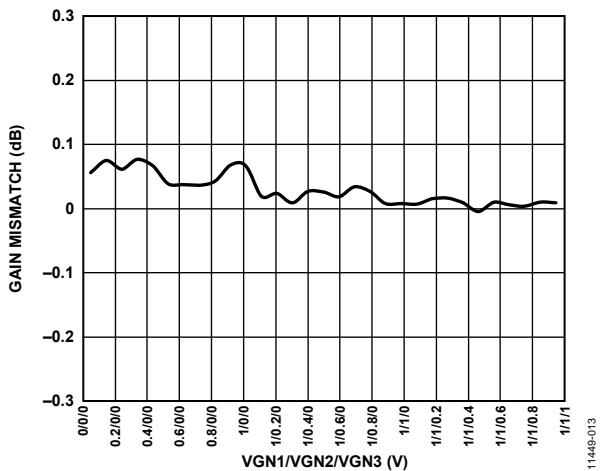

Figure 13. Gain Mismatch Between Channels vs. VGN1/VGN2/VGN3 Voltage

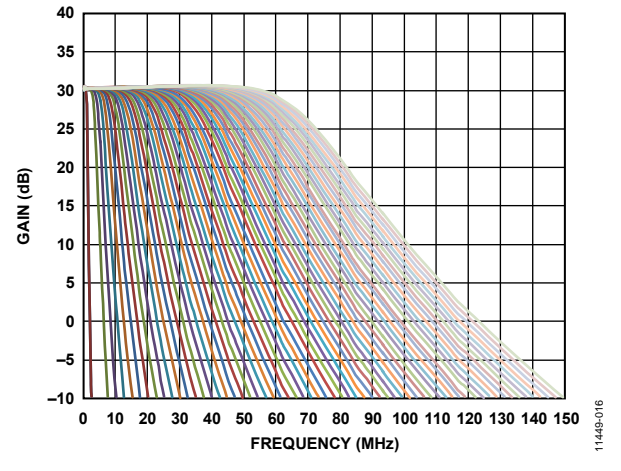

Figure 16. Gain vs. Frequency over BW Setting (Linear); VGN1/VGN2/VGN3 = 0 V

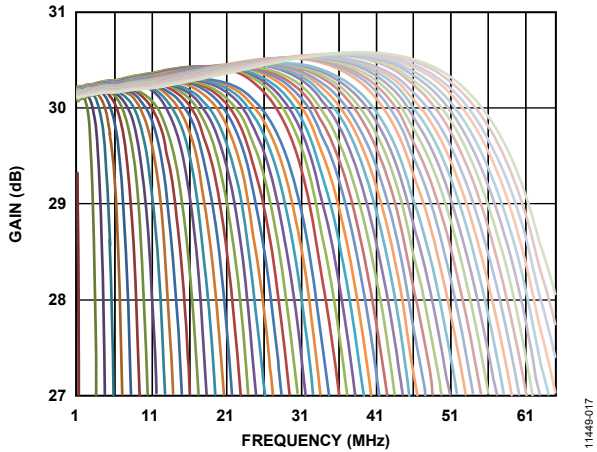

Figure 17. Gain vs. Frequency over BW Setting (Linear); Scaled to Show Peaking

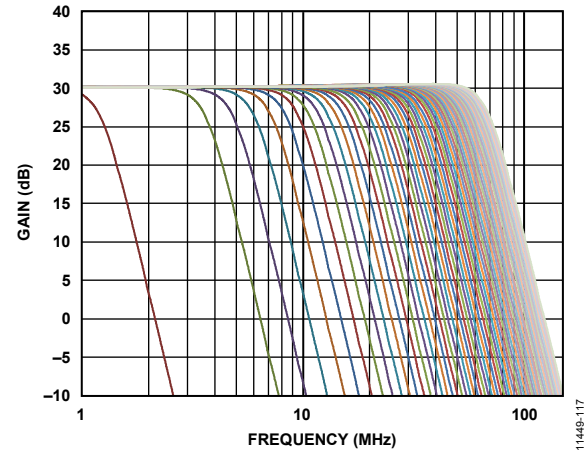

Figure 18. Gain vs. Frequency over BW Setting (Log); VGN1 = 1 V, VGN2 = 0.7 V, VGN3 = 0.75 V

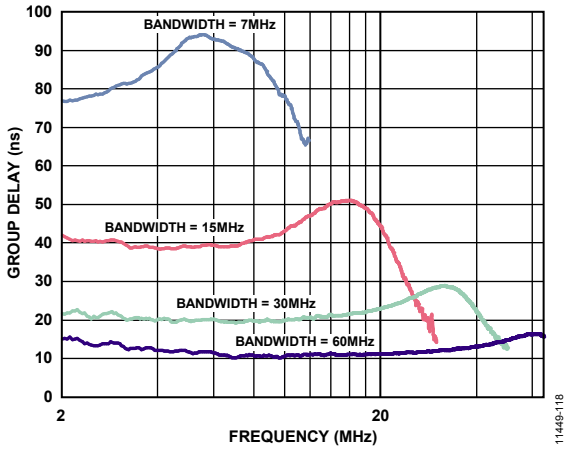

Figure 19. Group Delay vs. Frequency; VGN1/VGN2/VGN3 = 0 V

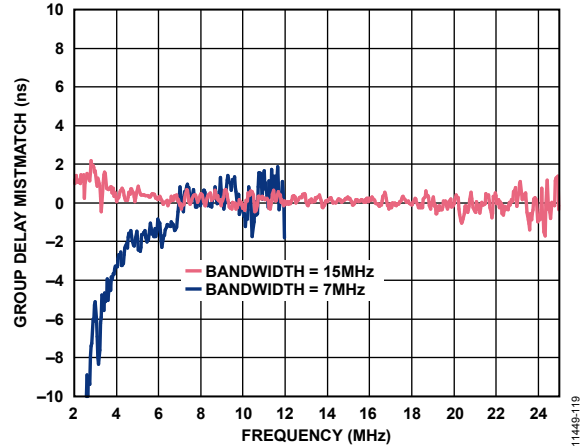

Figure 20. IQ Group Delay Mismatch vs. Frequency (BW = 7 MHz and BW = 15 MHz)

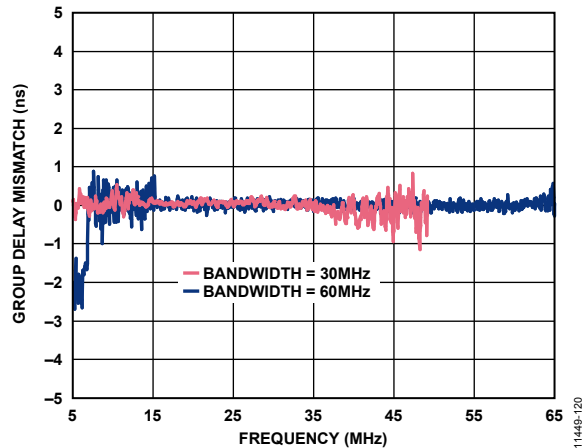

Figure 21. IQ Group Delay Mismatch vs. Frequency (BW = 30 MHz and BW = 60 MHz)

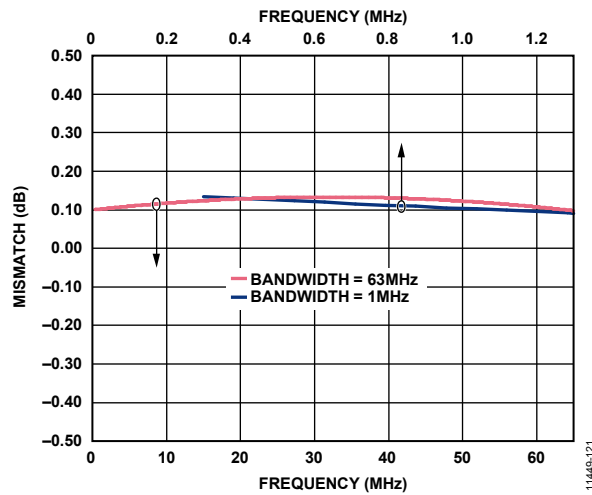

Figure 22. IQ Amplitude Mismatch vs. Frequency; VGN1/VGN2/VGN3 = 0 V

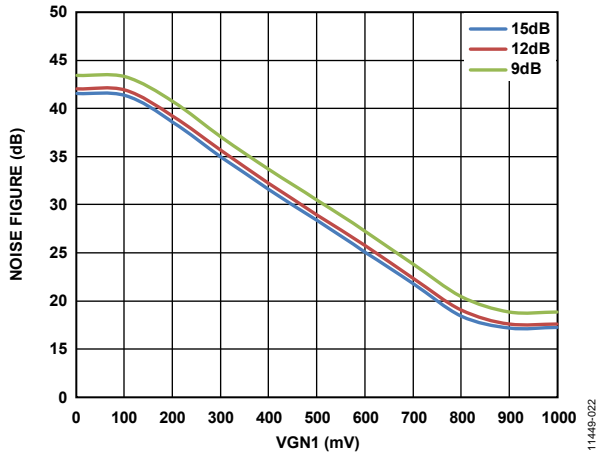

Figure 23. Noise Figure vs. VGN1 over VGA1 Digital Gain; Noise Density Measured at Half of Filter Corner

11449-022

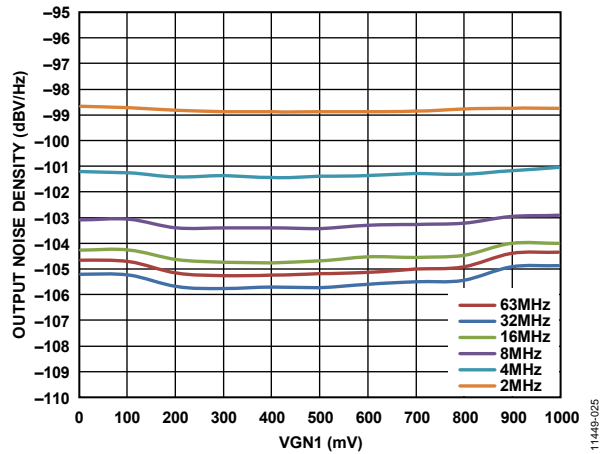

Figure 26. Output Noise Density vs. VGN1 over Bandwidth Setting; Digital Gain = 0000001, Noise Density Measured at Half of Filter Corner

11449-025

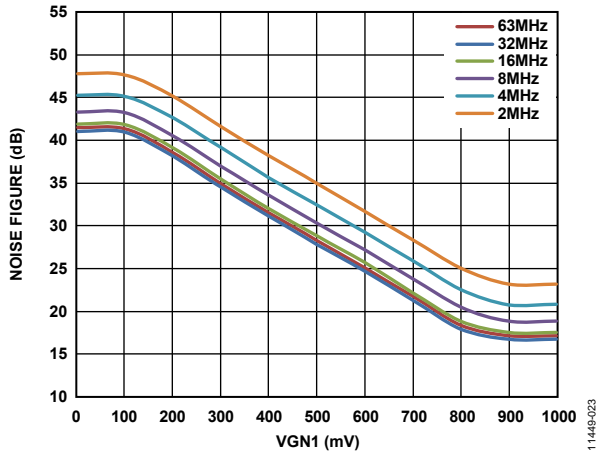

Figure 24. Noise Figure vs. VGN1 over Filter Corner; Digital Gain = 0000001, Noise Density Measured at Half of Filter Corner

11449-023

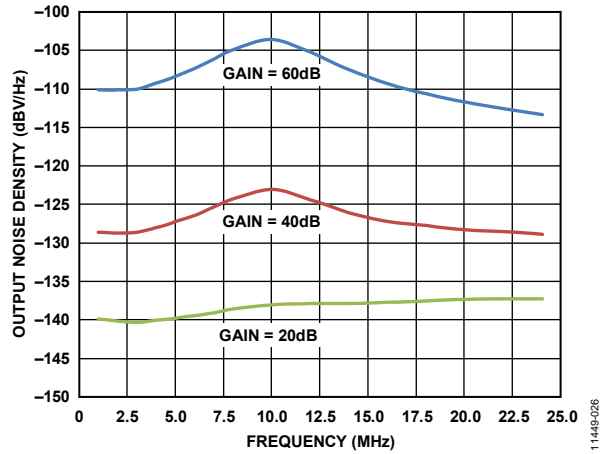

Figure 27. Output Noise Density vs. Frequency; Filter Corner = 7 MHz, Digital Gain = 0000001, Noise Density Measured at Half of Filter Corner

11449-026

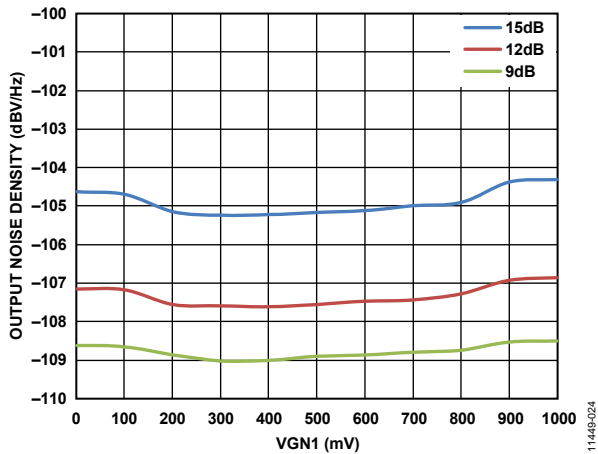

Figure 25. Output Noise Density vs. VGN1 over VGA1 Digital Gain; Noise Density Measured at Half of Filter Corner

11449-024

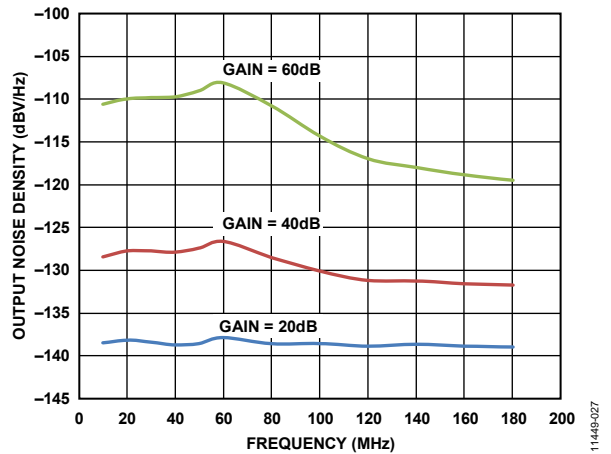

Figure 28. Output Noise Density vs. Frequency; Filter Corner = 60 MHz, Digital Gain = 0000001

11449-027

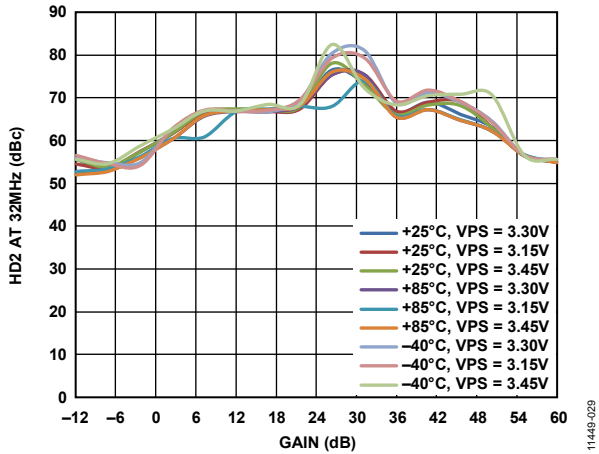

Figure 29. HD2 vs. Gain over Supply and Temperature; 16 MHz Fundamental Tone, Digital Gain = 0000000

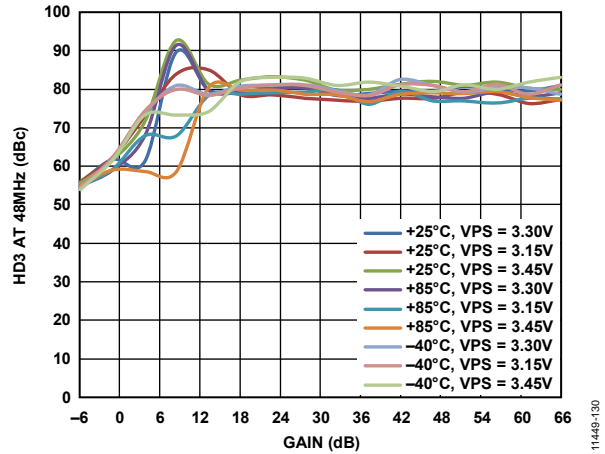

Figure 32. HD3 vs. Gain over Supply and Temperature; 16 MHz Fundamental Tone, Digital Gain = 0000001

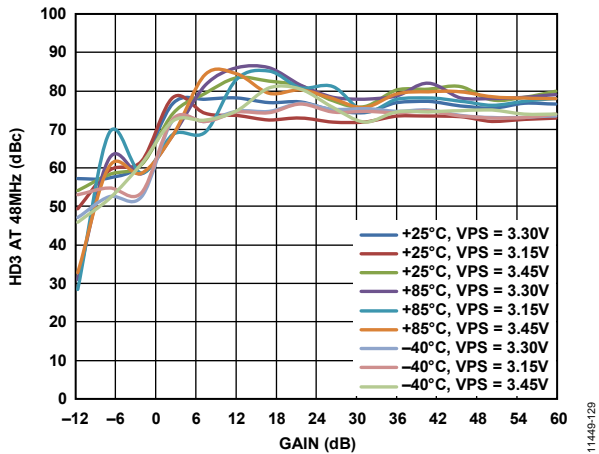

Figure 30. HD3 vs. Gain over Supply and Temperature; 16 MHz Fundamental Tone, Digital Gain = 0000000

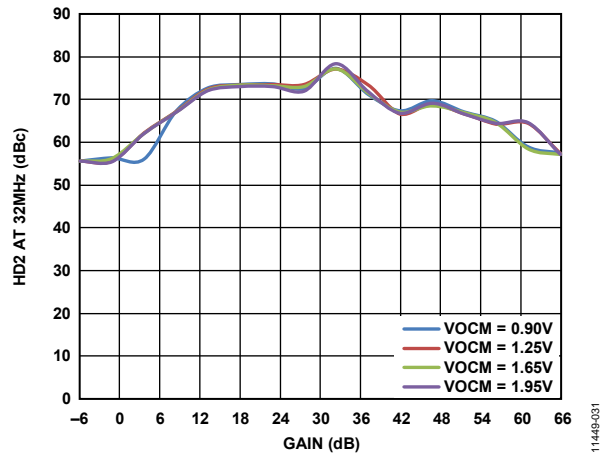

Figure 33. HD2 vs. Gain over VOCM; 16 MHz Fundamental Tone, Digital Gain = 0000001

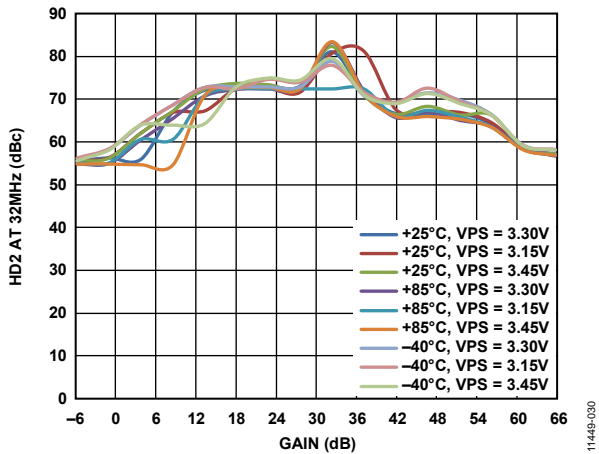

Figure 31. HD2 vs. Gain over Supply and Temperature; 16 MHz Fundamental Tone, Digital Gain = 0000001

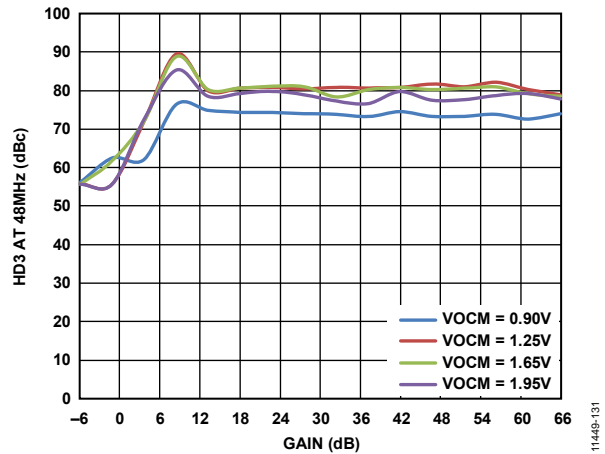

Figure 34. HD3 vs. Gain over VOCM; 16 MHz Fundamental Tone, Digital Gain = 0000001

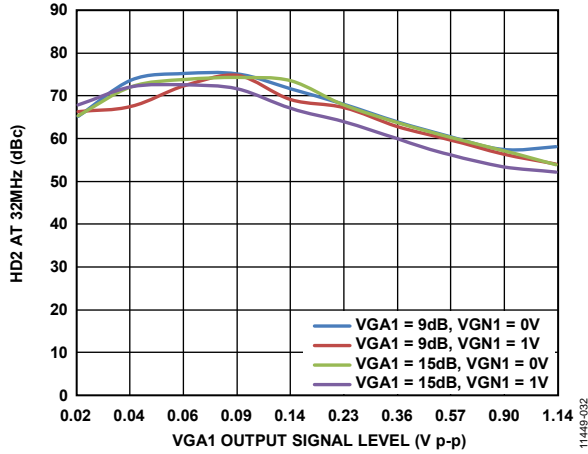

Figure 35. HD2 vs. VGA1 Output Signal Level (Inferred); 16 MHz Fundamental Tone, VGN2/VGN3 = 0 V

11449-032

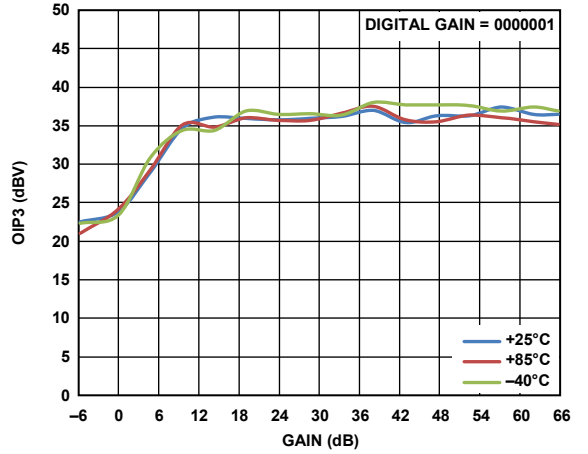

Figure 38. In-Band OIP3 vs. Gain over Temperature; 30 MHz and 31 MHz Tones, Digital Gain = 0000001

11449-135

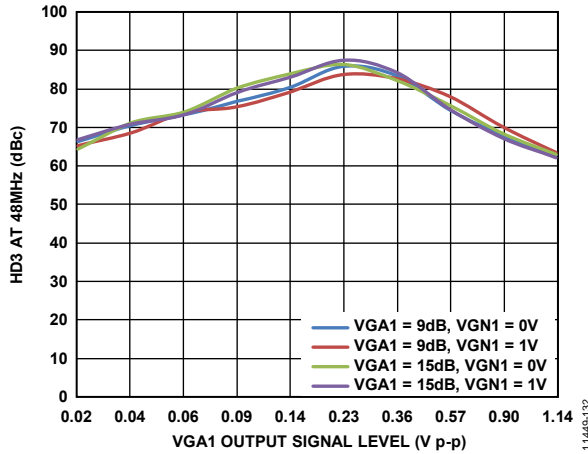

Figure 36. HD3 vs. VGA1 Output Signal Level (Inferred); 16 MHz Fundamental Tone, VGN2/VGN3 = 0 V

11449-132

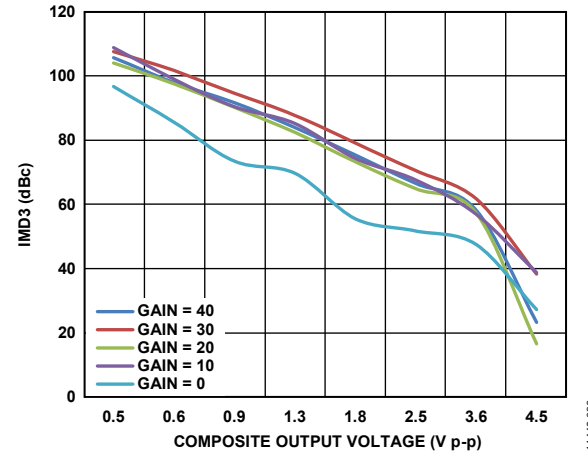

Figure 39. In-Band IMD3 vs. Composite Output Voltage over Gain; 30 MHz and 31 MHz Tones, Digital Gain = 1111110

11449-036

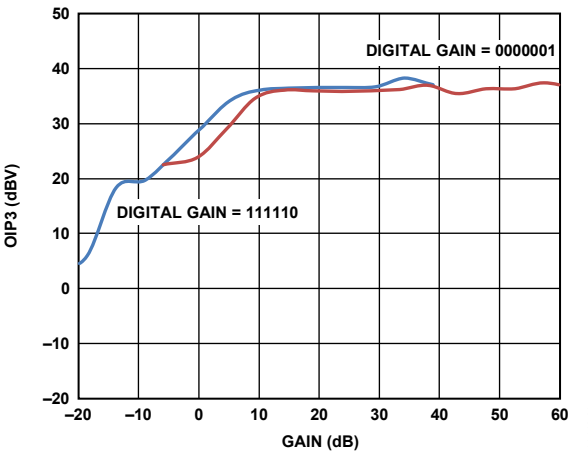

Figure 37. In-Band OIP3 vs. Gain over Digital Gain; 1.5 V p-p Composite Output Target, 30 MHz and 31 MHz Tones

11449-035

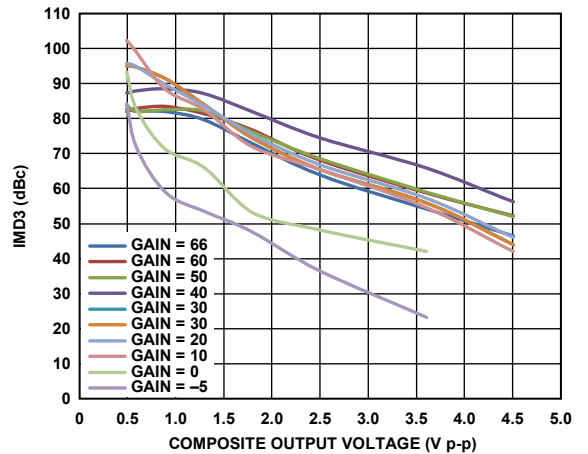

Figure 40. In-Band IMD3 vs. Composite Output Voltage over Gain; 30 MHz and 31 MHz Tones, Digital Gain = 0000001

11449-037

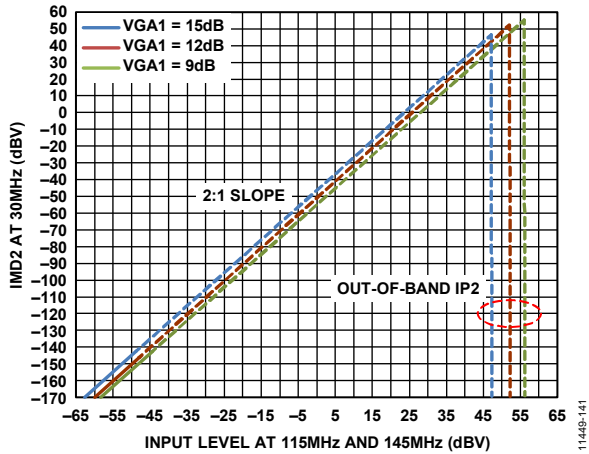

Figure 41. Out-of-Band IIP2, IMD2 vs. P_{IN} over Digital Gain; 115 MHz and 145 MHz Tones

11448-141

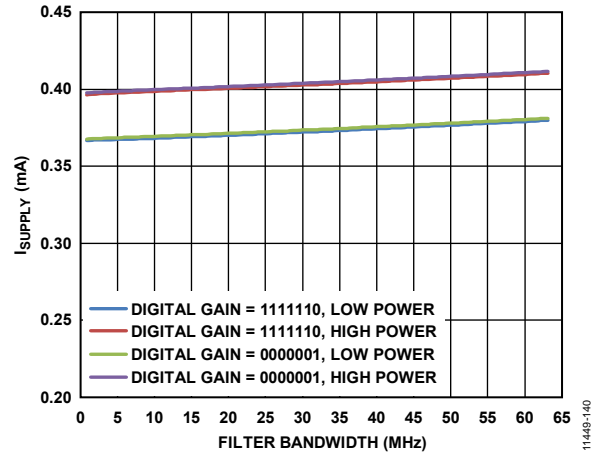

Figure 44. Supply Current vs. Filter Bandwidth over Digital Gain and Power Modes

11448-140

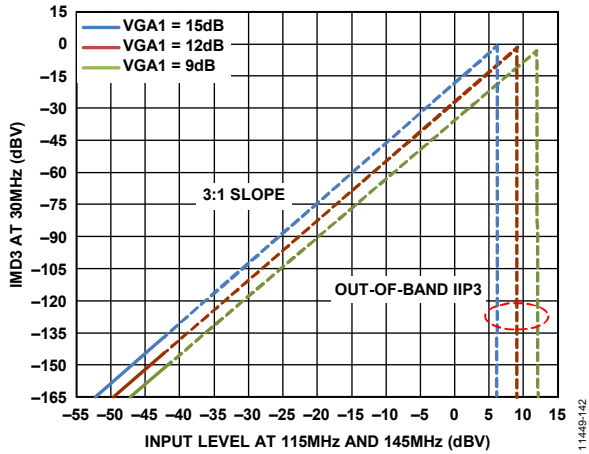

Figure 42. Out-of-Band IIP3, IMD3 vs. P_{IN} over Digital Gain; 115 MHz and 145 MHz Tones

11448-142

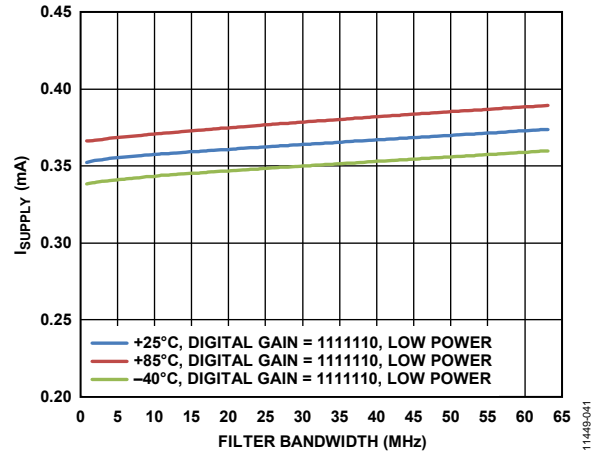

Figure 45. Supply Current vs. Filter Bandwidth over Temperature, Digital Gain, and Power Modes

11448-041

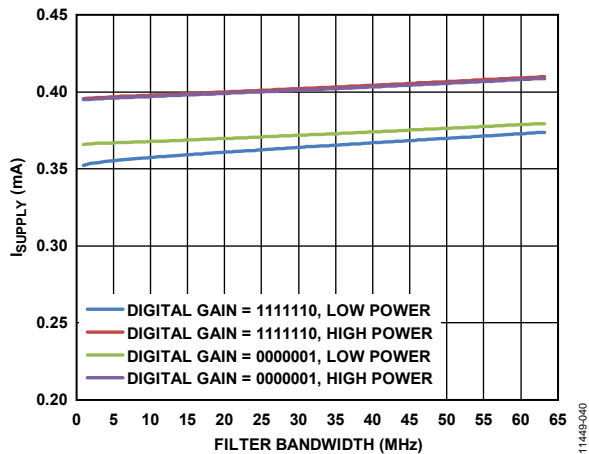

Figure 43. Supply Current vs. Filter Bandwidth over Digital Gain and Power Modes

11448-040

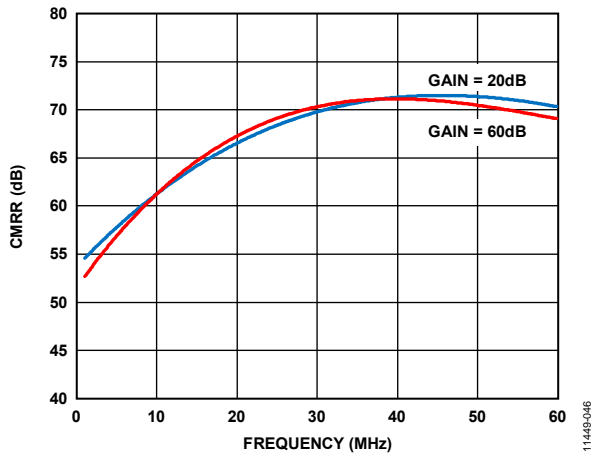

Figure 46. Common-Mode Rejection Ratio vs. Frequency

11448-046

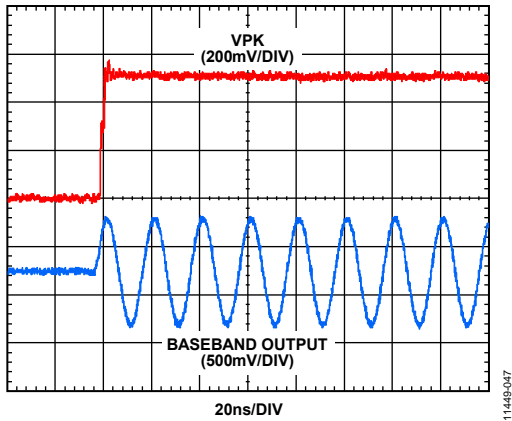

Figure 47. Peak Detector Time Domain Response

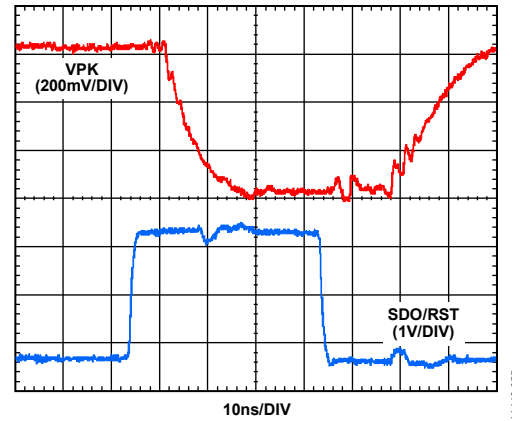

Figure 50. Peak Detector Hold Reset Time Domain Response

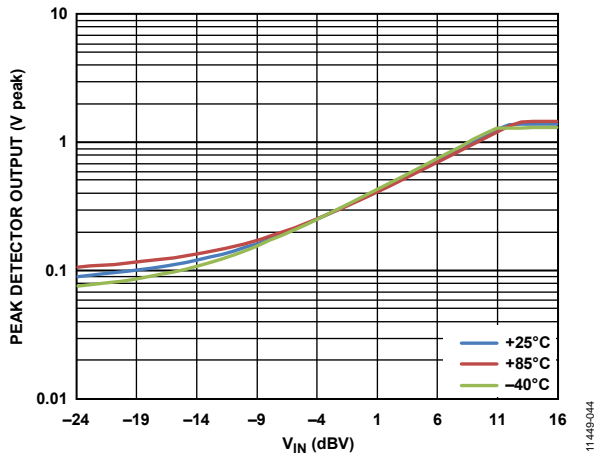

Figure 48. Peak Detector Output vs. V_{IN} over Temperature; $V_{GN1} = 0.5 V$, $V_{GN2} = V_{GN3} = 0 V$

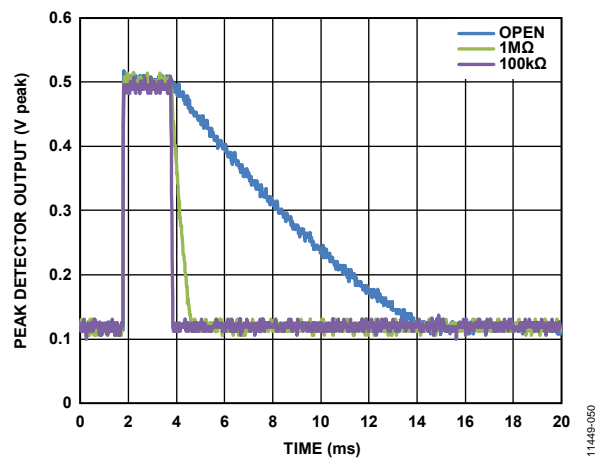

Figure 51. Peak Detector Hold Time Over R_{AVG}

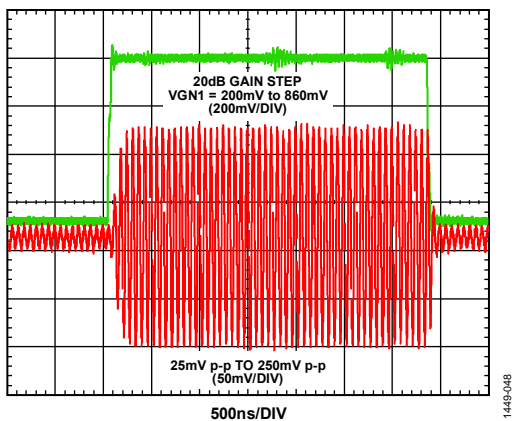

Figure 49. VGA1 Gain Step Response; $V_{GN2}/V_{GN3} = 0.5 V$, -24 dBV RMS Input Signal Level, $C27 = 100$ pF

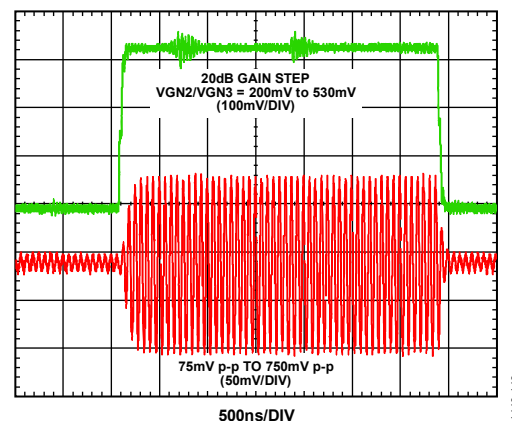

Figure 52. VGA2/VGA3 Gain Step Response; $V_{GN1} = 0.5 V$, -4 dBV RMS Input Signal Level, $C17$ and $C32 = 100$ pF

BYPASS MODE

VPS = 3.3 V, T_A = 25°C, Z_{LOAD} = 400 Ω, power mode bit (B9) = 1 (high power mode), digital gain code bits (B8 to B2) = 1111110, dc offset disable bit (B1) = 0 (enabled), unless otherwise noted.

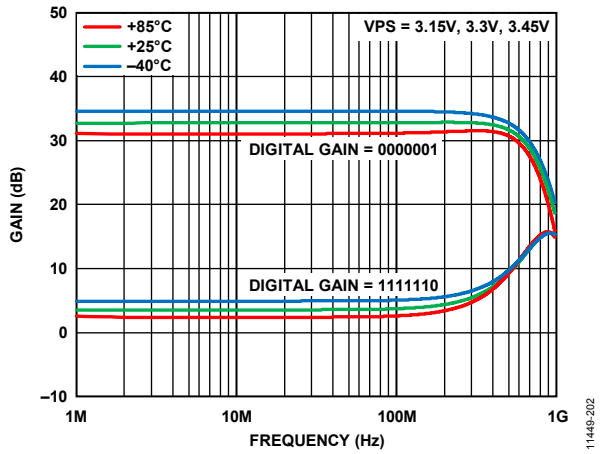

Figure 53. Frequency Response over Supply and Temperature

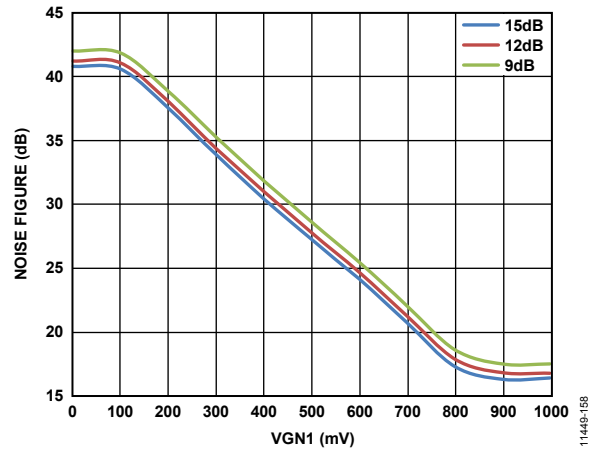

Figure 56. Noise Figure vs. VGN1 over Digital Gain

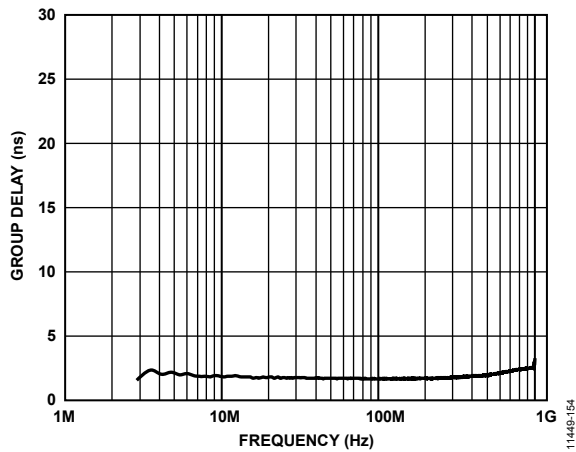

Figure 54. Group Delay vs. Frequency

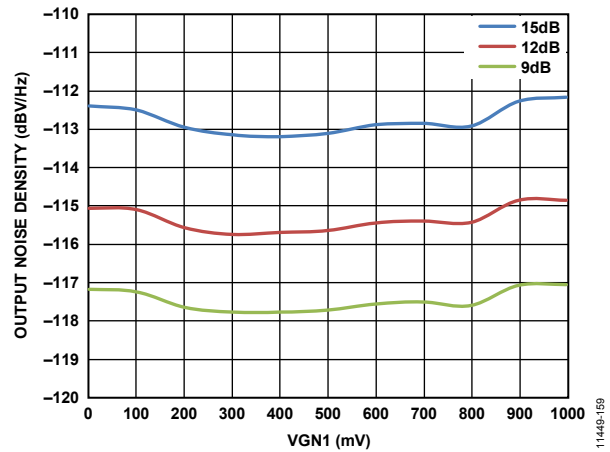

Figure 57. Output Noise Density vs. VGN1 over Digital Gain

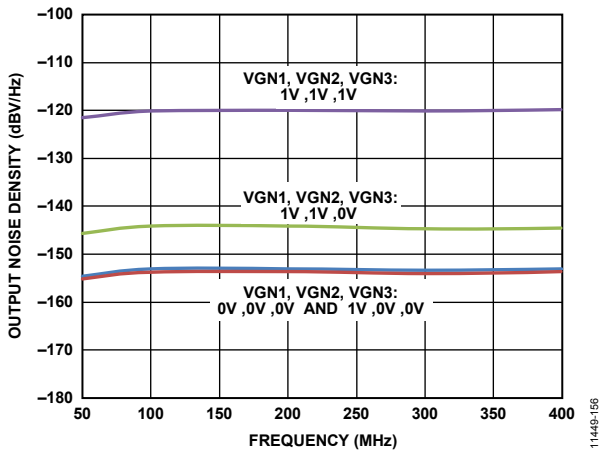

Figure 55. Output Noise Density vs. Frequency over Analog Gains; Digital Gain = 0000001

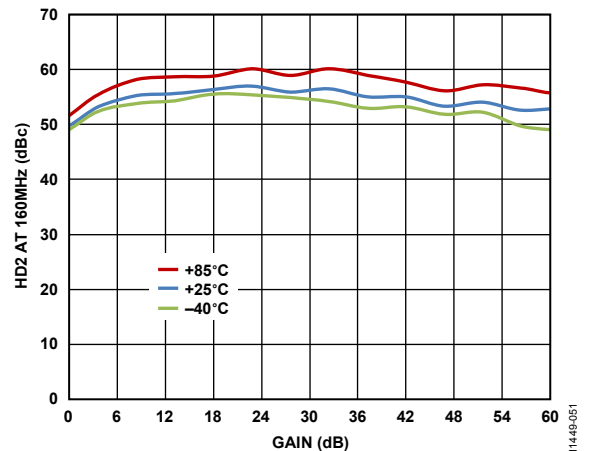

Figure 58. HD2 vs. Gain over Temperature; Fundamental at 80 MHz, Digital Gain = 0000001

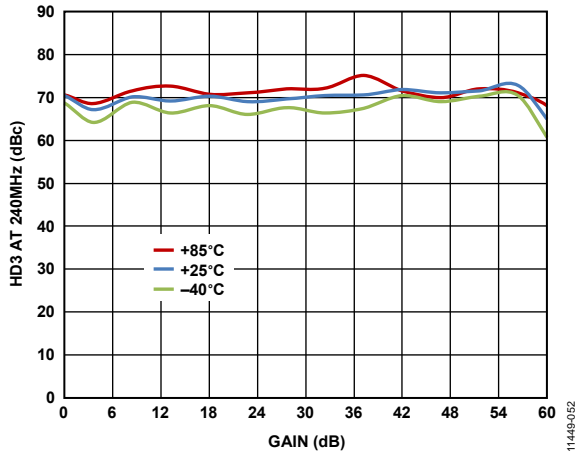

Figure 59. HD3 vs. Gain over Temperature; Fundamental at 80 MHz, Digital Gain = 0000001

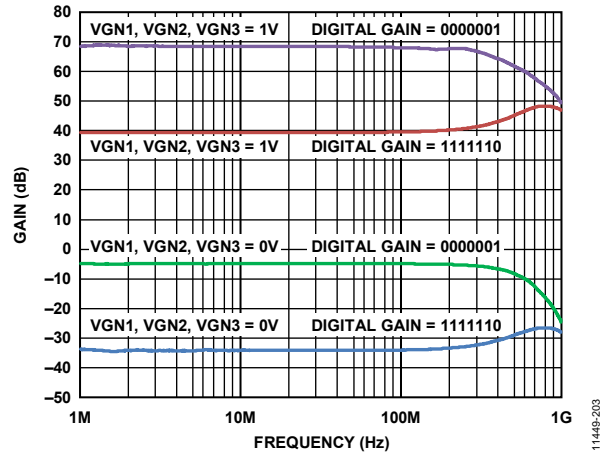

Figure 62. Gain vs. Frequency

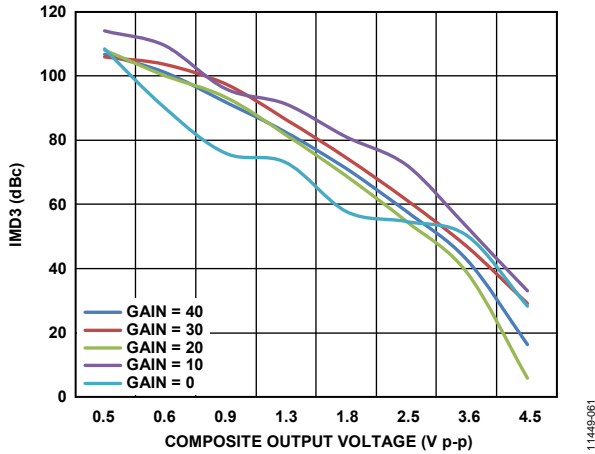

Figure 60. IMD3 vs. Composite Output Voltage over V_{OCM} ; $V_{GN1}/V_{GN2}/V_{GN3} = 1\text{ V}$, 125 MHz and 126 MHz Tones

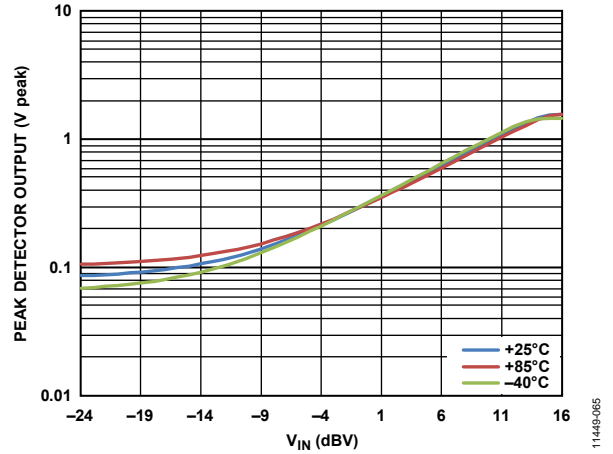

Figure 63. Peak Detector Output vs. V_{IN} over Temperature; $V_{GN1} = 0.5\text{ V}$, $V_{GN2}/V_{GN3} = 0\text{ V}$; 125 MHz Tone

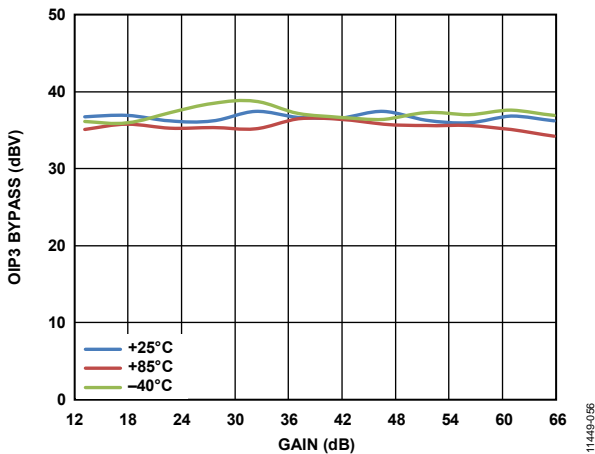

Figure 61. In-Band OIP3 Bypass vs. Gain over Temperature; Digital Gain = 0000001, 125 MHz and 126 MHz Tones

MIXED POWER AND FILTER MODES

VPS = 3.3 V, T_A = 25°C, Z_{LOAD} = 400 Ω, digital gain code bits (B8 to B2) = 111110, dc offset disable bit (B1) = 0 (enabled), unless otherwise noted.

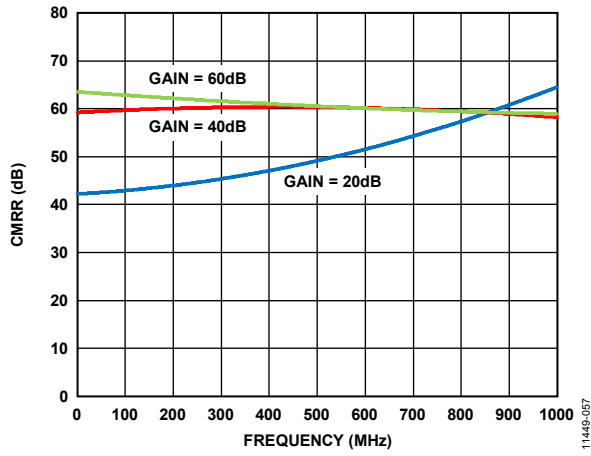

Figure 64. Common-Mode Rejection Ratio (CMRR) vs. Frequency

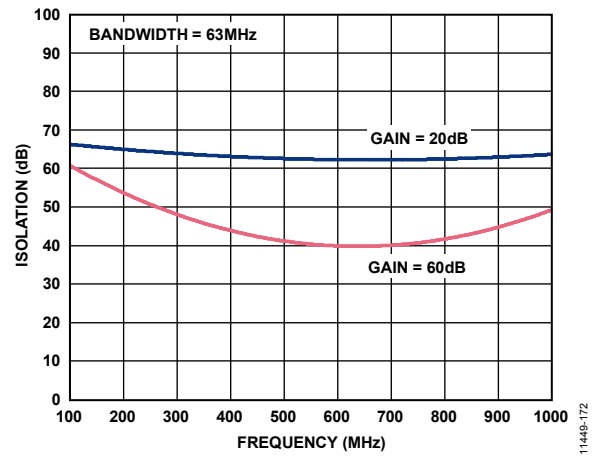

Figure 66. Channel Isolation (OPM1_SE to OPM2_SE) vs. Frequency, Bypass Mode

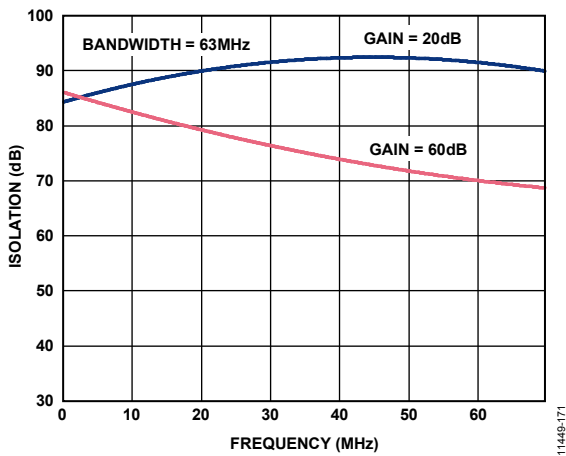

Figure 65. Channel Isolation (OPM1_SE to OPM2_SE) vs. Frequency, Filter Mode

CHARACTERIZATION

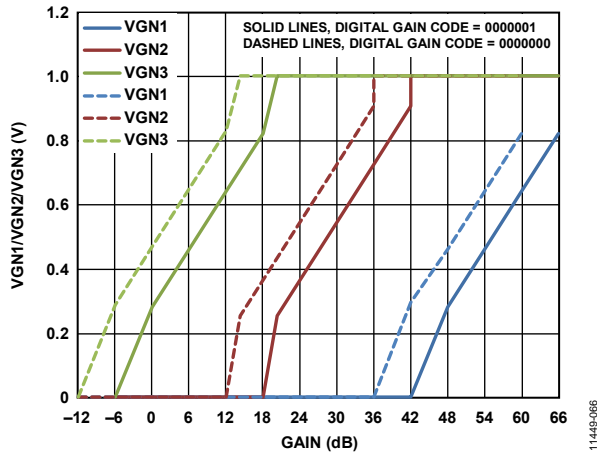

Figure 67. Gain Distribution for HD2/HD3 vs. Gain

Figure 67 shows the ADRF6518 analog gain distribution for the HD2 vs. gain and HD3 vs. gain plots while the gain and input voltage levels were swept and while keeping the output voltage level at 1.5 V p-p.

NOISE FIGURE CALCULATION

All of the noise figure plots (see Figure 23, Figure 24, and Figure 56) were completed by input referring the output noise density and then dividing it by the theoretical noise density of a 50 Ω resistor. The input SMA on the evaluation board was terminated with a 50 Ω resistor to ground, which provided the ADRF6518 input with a 400 Ω differential impedance via the 8:1 balun. In signal chain calculations, it is often convenient to reference the noise figure to 50 Ω, even though the ADRF6518 input is terminated in 400 Ω.

The noise factor is calculated as follows:

$$Noise\ Factor = \frac{N_{OUT}/GAIN}{N_{50\Omega}}$$

where the noise densities are in nV/√Hz and GAIN is in linear terms. The noise figure is then

$$Noise\ Figure = 10 \log_{10}(Noise\ Factor)$$

REGISTER MAP AND CODES

The filter frequency, amplifier gains, filter bypass mode, and offset correction loops can be programmed using the SPI interface. Table 5 provides the bit map for the internal 15-bit register of the [ADRF6518](#).

Table 4. Filter Mode and Power Mode Options

B9	Filter Bypass	Filter
0	VGA low power; filter off	VGA low power; filter low power
1	VGA high power; filter off	VGA low power; filter high power

Table 5. Register Map

MSB						LSB								
B15	B14	B13	B12	B11	B10	B9	B8	B7	B6	B5	B4	B3	B2	B1
Filter frequency code and filter bypass mode						Power mode	Digital gain code						DC offset disable	
Code = 1 dB corner in MHz For example, 31 MHz = 011111 (MSB first) Use 000000 for filter bypass mode						0: low power 1: high power Use 1 for filter BW > 31 MHz, in filter mode Use 1 for channel BW > 60 MHz, in filter bypass mode	VGA1 gain 00: 15 dB 01: 12 dB 10: 9 dB 11: 9 dB	VGA2 gain 00: 21 dB 01: 18 dB 10: 15 dB 11: 12 dB	VGA3 gain 00: 21 dB 01: 18 dB 10: 15 dB 11: 12 dB	Postamp 0: 3 dB 1: 9 dB			0: enable 1: disable	

THEORY OF OPERATION

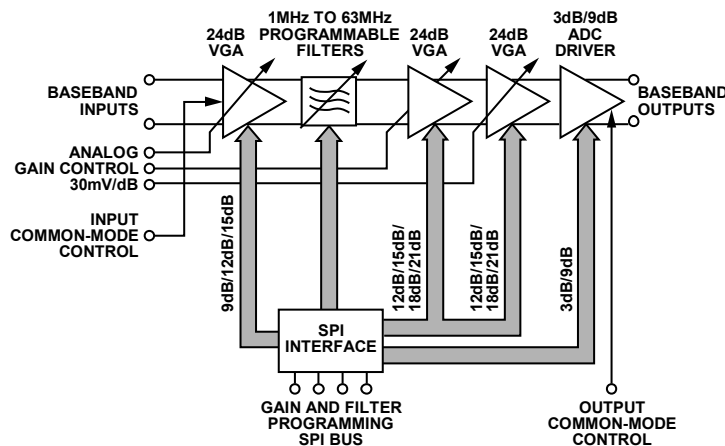

Figure 68. Signal Path Block Diagram for a Single Channel of the ADRF6518

The ADRF6518 consists of a matched pair of input VGAs followed by programmable filters, and then by a cascade of two variable gain amplifiers and output ADC drivers. The filters can be bypassed and powered down through the SPI interface for operation beyond the maximum filter bandwidth. The block diagram of a single channel is shown in Figure 68.

The programmability of the filter bandwidth and of the prefiltering and postfiltering fixed gains through the SPI interface offers great flexibility when coping with signals of varying levels in the presence of noise and large, undesired signals near the desired band. The entire differential signal chain is dc-coupled with flexible interfaces at the input and output. The bandwidth and gain setting controls for the two channels are shared, ensuring close matching of their magnitude and phase responses. The ADRF6518 can be fully disabled through the ENBL pin.

Filtering and amplification are fundamental operations in any signal processing system. Filtering is necessary to select the intended signal while rejecting out-of-band noise and interferers. Amplification increases the level of the desired signal to overcome noise added by the system. When used together, filtering and amplification can extract a low level signal of interest in the presence of noise and out-of-band interferers. Such analog signal processing alleviates the requirements on the analog, mixed signal, and digital components that follow.

INPUT VGAs

The input VGAs provide a convenient interface to the sensitive filter sections that follow. They are designed to have a low noise figure and high linearity. The combination of analog gain control and digital gain settings allow a wide range of input signal levels to be conditioned to drive the filters at up to 1.5 V p-p amplitude. The VGAs set a differential input impedance of 400 Ω .

The baseband input signal can be ac-coupled or dc-coupled via Pin 7 selection. When the signal is dc-coupled, the wide input common-mode voltage is supported by having an optional 5 V supply on Pin 8, VPI. The default common-mode voltage is VPI/2, which is available on the dual function Pin 7, VICM/AC,

to set the output common-mode voltage of the driving circuit. However, this is optional and input common-mode can be independently set within the supported range. For a 3.3 V supply on VPI, the input common mode can range from 1.35 V to 1.95 V, while maintaining a 5 V p-p input level at >60 dBc HD2 and HD3. For a 5 V supply on VPI, the input common-mode range extends to 1.35 V to 3.1 V. Extra current is drawn from the VPI supply to support an input common mode greater than the midvalue of the main 3.3 V supply, that is, VPS/2.

The VICM/AC voltage is not buffered and must be sensed at a high impedance point to prevent it from being loaded down. When the baseband input signal is ac-coupled, pull the VICM/AC pin low to activate the internal bias for the input stage.

The input VGAs have analog gain control of 24 dB, followed by a digital gain settings of 9 dB, 12 dB, or 15 dB, selectable through the SPI (see the Register Map and Codes section). The VGAs are based on the Analog Devices, Inc., patented X-AMP® architecture, consisting of tapped 24 dB attenuators, followed by programmable gain amplifiers. The X-AMP architecture generates a continuous linear-in-dB monotonic gain response with low ripple. The analog gain of the VGA sections are controlled through the high impedance VGN1 pin with an accurate slope of 30 mV/dB. Adjust the VGA analog gain through an AGC mechanism, such that 1.5 V p-p at the output of the first VGA is not exceeded. If, however, the input signal is small enough, the first VGA can be set at full gain for best noise figure (NF) performance and gain control achieved in the second or third VGA.

Driving ADRF6518 Single-Ended

The input structure of the ADRF6518 is designed for differential drive. However, with some performance degradation, it can be driven single-ended, especially at low bandwidth signals. See the Applications Information section for guidance on single-ended drive.

PEAK DETECTOR

To measure the signal level at the critical interface of the VGA1 output and the programmable filter input, a peak detector has been implemented. The peak detector simultaneously measures both channels at the VGA1 output and reports the bigger of the two at the VPK pin. The on-chip holding capacitor and negligible leakage at the internal node ensure a large droop time of the order of a millisecond, which is a function of the peak voltage as well. Bigger peak voltage results in longer droop time. The droop time can be adjusted down by placing a resistor between the RAVG and VPS pins. Typical values of RAVG can range from 1 MΩ to 1 kΩ. As the RAVG resistor value is reduced, the peak voltage, VPK, appears as an envelope output. The peak detector has the attack bandwidth of 100 MHz.

The peak detector can be used in an AGC loop to set the appropriate signal level at the filter input. For such an implementation, filter VPK appropriately, considering that it is a peak hold output. A high pulse of 25 ns or longer duration applied to the SDO/RST dual function pin resets the VPK voltage to 0 V by discharging the internal holding capacitor.

PROGRAMMABLE FILTERS

The integrated programmable filter is the key signal processing function in the ADRF6518. The filters follow a six-pole Butterworth prototype response that provides a compromise between band rejection, ripple, and group delay. The 0.5 dB bandwidth is programmed from 1 MHz to 63 MHz in 1 MHz steps via the serial programming interface (SPI) as described in the Programming the ADRF6518 section.

The filters are designed so that the Butterworth prototype filter shape and group delay responses vs. frequency are retained for any bandwidth setting. Figure 69 and Figure 70 illustrate the ideal six-pole Butterworth response. The group delay, τ_g , is defined as

$$\tau_g = -\partial\phi/\partial\omega$$

where:

ϕ is the phase in radians.

$\omega = 2\pi f$ is the frequency in radians per second.

Note that for a frequency scaled filter prototype, the absolute magnitude of the group delay scales inversely with the bandwidth; however, the shape is retained. For example, the peak group delay for a 28 MHz bandwidth setting is 14× less than for a 2 MHz setting.

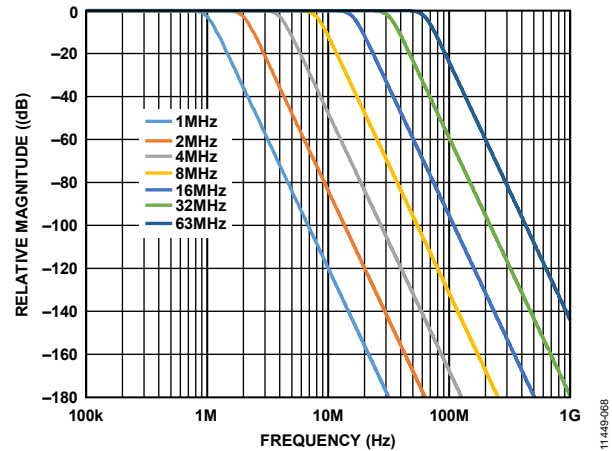

Figure 69. Sixth-Order Butterworth Magnitude Response for 0.5 dB Bandwidths

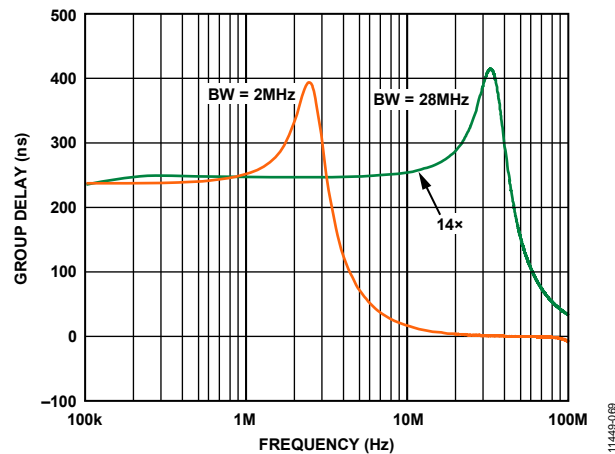

Figure 70. Sixth-Order Butterworth Group Delay Response for 0.5 dB Bandwidths Programmed to 2 MHz and 28 MHz

The corner frequency of the filters is defined by RC products, which can vary by ±30% in a typical process. Therefore, all the parts are factory calibrated for corner frequency, resulting in a residual ±8% corner frequency variation over the -40°C to +85°C temperature range. Although absolute accuracy requires calibration, the matching of RC products between the pair of channels is better than 1% by observing careful design and layout practices. Calibration and excellent matching ensure that the magnitude and group delay responses of both channels track together, a critical requirement for digital IQ-based communication systems.

Bypassing the Filters

For higher bandwidth applications, filters of the ADRF6518 can be bypassed via the SPI. In the filter bypass mode, filters are disabled and power consumption is significantly reduced. The bandwidth of cascaded VGAs, which is significantly larger than 63 MHz maximum of the filters, is fully realized in the filter bypass mode.

VARIABLE GAIN AMPLIFIERS (VGAs)

The cascaded VGA2 and VGA3 are also based on the X-AMP architecture, and each has 24 dB gain range with separate high impedance gain control inputs, VGN2 and VGN3. The VGA structures of the second and third VGAs are identical to that of the first VGA. However, these have slightly higher noise figure and less drive level capability. Their output is rated at 1 V p-p for >60 dBc HD2 and HD3. Depending on the input signal range, the second or third VGA or both can be used for AGC purposes. The critical level to consider while making this choice is the signal level at the output of the VGAs, which must not exceed 1 V p-p to maintain low distortion.

The fixed gain following both of the variable gain sections can also be programmed to 12 dB, 15 dB, 18 dB, or 21 dB to maximize the dynamic range.

OUTPUT BUFFERS/ADC DRIVERS

The low impedance (<10 Ω) output buffers of the [ADRF6518](#) are designed to drive either ADC inputs or subsequent amplifier stages. They are capable of delivering up to 4 V p-p composite two-tone signals into 400 Ω differential loads with >60 dBc IMD3. The output common-mode voltage defaults to VPS/2, but it can be adjusted from 900 mV to VPS – 1.2 V without loss of drive capability by presenting the VOVM pin with the desired common-mode voltage. The high input impedance of VOVM allows the ADC reference output to be connected directly. Even though the output common-mode voltage is adjustable, and the offset compensation loop can null the accumulated dc offsets (see the DC Offset Compensation Loop section), it may still be desirable to ac-couple the outputs by selecting the coupling capacitors according to the load impedance and desired bandwidth.

DC OFFSET COMPENSATION LOOP

In many signal processing applications, no information is carried in the dc level. In fact, dc voltages and other low frequency disturbances can often dominate the intended signal and consume precious dynamic range in the analog path and bits in the data converters. These dc voltages can be present with the desired input signal or can be generated inside the signal path by inherent dc offsets or other unintended signal-dependent processes such as self-mixing or rectification.

Because the [ADRF6518](#) is fully dc-coupled, it may be necessary to remove these offsets to realize the maximum signal-to-noise ratio (SNR). The external offsets can be eliminated with ac-coupling capacitors at the input pins; however, that requires large value capacitors because the impedances can be fairly low, and high-pass corners may need to be <10 Hz in some cases. To address the issue of dc offsets, the [ADRF6518](#) provides an offset correction loop that nulls the output differential dc level, as shown in Figure 71. If the correction loop is not required, it can be disabled through the SPI port.

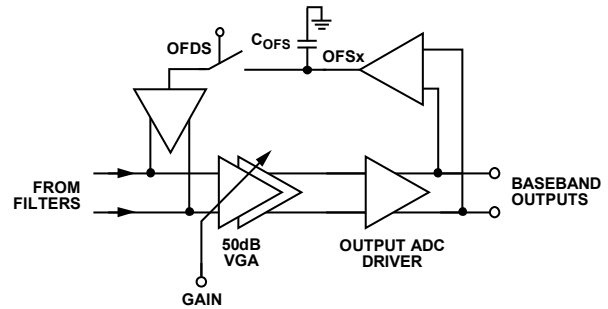

Figure 71. Offset Compensation Loop Operates Around the VGA and Output Buffer

The offset control loop creates a high-pass corner, f_{HP} , that is superimposed on the normal Butterworth filter response when filters are enabled. Typically, f_{HP} is many orders of magnitude lower than the lower programmed filter bandwidth so that there is no interaction between them. Setting f_{HP} is accomplished with capacitors, C_{OFS} , from the OFS1 and OFS2 pins to ground. Because the correction loop works around the VGA sections, f_{HP} is also dependent on the total gain of the cascaded VGAs. In general, the expression for f_{HP} is given by

$$f_{HP} \text{ (Hz)} = 6.7 \times \text{Post Filter Linear Gain} / C_{OFS} \text{ (}\mu\text{F)}$$

where *Post Filter Linear Gain* is expressed in linear terms, not in decibels (dB), and is the gain following the filters, which excludes the VGA1 gain.

Note that f_{HP} increases in proportion to the gain. For this reason, choose C_{OFS} at the highest operating gain to guarantee that f_{HP} is always below the maximum limit required by the system.

PROGRAMMING THE ADRF6518

The 0.5 dB corner frequencies for both filters, the digital gains of all the VGAs, and the output buffers are programmed simultaneously through the SPI port. In addition to these, enabling the dc offset compensation loop and power mode selection are also controlled through SPI port. A 16-bit register stores 15 data bits, including the 6-bit code for corner frequencies of 1 MHz through 63 MHz and filter bypass, as well as the codes for VGA gains, and the postamplifier gain (see Table 5). The SPI protocol not only allows these selections to be written to the DATA pin, but also allows the stored code to be read back via the SDO/RST pin.

The latch enable (LE) pin must first go to a Logic 0 for a read or write cycle to begin. On the next rising edge of the clock (CLK), a Logic 1 on the DATA pin initiates a write cycle, whereas a Logic 0 on the DATA pin initiates a read cycle. In a write cycle, the next 15 CLK rising edges latch the desired 15-bit code, LSB first. This results in 16-bit code, including the first Logic 1 to initiate a write cycle. When LE goes high, the write cycle is completed and different codes are presented various blocks that need programming. In a read cycle, the next 15 CLK falling edges present the stored 15-bit code, LSB first. When LE goes high, the read cycle is completed. Detailed timing diagrams are shown in Figure 2 and Figure 3.

NOISE CHARACTERISTICS

The output noise behavior of the [ADRF6518](#) depends on the gain and bandwidth settings. VGA1 noise dominates in the filter bypass mode and at high filter corner settings. While at low corner settings, filter noise tends to dominate.

The filter contributes a noise spectral density profile that is flat at low frequencies, peaks near the corner frequency, and then rolls off as the filter poles roll off the gain and noise. The magnitude of the noise spectral density contributed by the filter, expressed in nV/\sqrt{Hz} , varies inversely with the square root of the bandwidth setting, resulting in filter noise in nV that is nearly constant with the bandwidth setting. However, with VGA1 NF being lower than the filter, VGA1 tends to dominate the overall NF. At higher frequencies, after the filter noise rolls off, the noise floor is set by the VGAs.

Each of the X-AMP VGA sections used in the [ADRF6518](#) contributes a fixed noise spectral density to its respective output, independent of the analog gain setting. With the digital gain change, however, VGA output noise changes, because the gain setting resistors values change. As an example, the VGA1 NF corresponding to a 15 dB gain setting is 17.3 dB, whereas for a 9 dB gain, the NF is 19 dB. When cascaded, the total noise contributed by the VGAs at the output of the [ADRF6518](#) increases gradually with higher gain. This is apparent in the noise floor variation at high frequencies at different VGA gain settings. The exact relationship depends on the programmed fixed gain of the amplifiers. At lower frequencies within the filter bandwidth setting, the VGAs translate the filter noise directly to the output by a factor equal to the gain following the filter.

At low values of VGA gain, the noise at the output is the flat spectral density contributed by the last VGA. As the gain increases, more of the filter and first VGA noise appears at the output. Because the intrinsic filter noise density increases at lower bandwidth settings, it is more pronounced than it is at higher bandwidth settings. In either case, the noise density asymptotically approaches the limit set by the VGAs at the highest frequencies. For other values of VGA gain and bandwidth setting, the detailed shape of the noise spectral density changes according to the relative contributions of the filters and VGAs.

Because the noise spectral density outside the filter bandwidth is limited by the VGA output noise, it may be necessary to use an external, fixed frequency, passive filter prior to analog-to-digital conversion to prevent noise aliasing from degrading the signal-to-noise ratio. A higher sampling rate, relative to the maximum required [ADRF6518](#) corner frequency setting, reduces the order and complexity of this external filter.

DISTORTION CHARACTERISTICS

To maintain low distortion through the cascaded VGAs and filter of the [ADRF6518](#), consider the distortion limits of each stage. The first VGA has higher signal handling capability and bandwidth than VGA2 and VGA3, because it must cope with out-of-band signals that can be larger than the in-band signals.

In the filter mode, these out-of-band signals are filtered before reaching VGA2 and VGA3. It is important to understand the signals presented to the [ADRF6518](#) and to match these signals with the input and output characteristics of the part. It is useful to partition the [ADRF6518](#) into the front end, composed of VGA1 and the filter, and the back end, composed of VGA2 and VGA3 and the output buffers.

VGA1 can handle a 5 V p-p signal at a maximum analog attenuation setting, without experiencing appreciable distortion at the input. In most applications, VGA1 gain should be adjusted such that the maximum signal presented at the filter inputs (or VGA2 input in filter bypass mode) is <1.5 V p-p. At this level, the front end does not limit the distortion performance. The peak detector output, VPK, can be used as an indicator of the signal level present at this critical interface. Choose the second and third VGA gains such that their output levels do not exceed 1 V p-p. If the output signal level is expected to exceed 1.5 V p-p, it is recommended to set the postamplifier gain to 9 dB.

For these signal level considerations, it is recommended that the out-of-band signal, if larger than the desired in-band signal, be addressed. In filter mode, such an out-of-band signal only affects the VGA1 operation, because it is filtered out by the filter and does not affect the following stages. In this case, a high VGA2 and VGA3 gain may be needed to raise the small desired signal to a higher level at the output. In the filter bypass mode, such out-of-band signals may need to be filtered prior to the [ADRF6518](#).

The overall distortion introduced by the part depends on the input drive level, including the out-of-band signals, and the desired output signal level. To achieve best distortion performance and the desired overall gain, keep in mind the maximum signal levels indicated previously when selecting different VGA gains.

To distinguish and quantify the distortion performance of the input section, two different IP3 specifications are presented. The first is called in-band IP3 and refers to a two-tone test where the signals are inside the filter bandwidth. This is exactly the same figure of merit familiar to communications engineers in which the third-order intermodulation level, IMD3, is measured.

To quantify the effect of out-of-band signals, a new out-of-band (OOB) IIP3 figure of merit is introduced. This test also involves a two-tone stimulus; however, the two tones are placed out-of-band so that the lower IMD3 product lands in the middle of the filter pass band. At the output, only the IMD3 product is visible because the original two tones are filtered out. To calculate the OOB IIP3 at the input, the IMD3 level is referred to the input by the overall gain. The OOB IIP3 allows the user to predict the impact of out-of-band blockers or interferers at an arbitrary signal level on the in-band performance. The ratio of the desired input signal level to the input-referred IMD3 at a given blocker level represents a signal-to-distortion limit imposed by the out-of-band signals.

MAXIMIZING THE DYNAMIC RANGE

When used in the filter mode, the role of the [ADRF6518](#) is to increase the level of a variable in-band signal while minimizing out-of-band signals. Ideally, this is achieved without degrading the SNR of the incoming signal or introducing distortion to the incoming signal.

The first goal is to maximize the output signal swing, which can be defined by the ADC input range or the input signal capacity of the next analog stage. For the complex waveforms often encountered in communication systems, the peak-to-average ratio, or crest factor, must be considered when choosing the peak-to-peak output. From the chosen output signal and the maximum gain of the [ADRF6518](#), the minimum input level can be defined.

As the input signal level increases, the VGA3 gain is reduced from its maximum gain point to maintain the desired fixed output level. VGA2 and VGA1 can then be adjusted as the input signal level keeps increasing. This maintains the best NF for the cascaded chain. The output noise, initially dominated by the filter and VGA1 combination, follows the gain reduction, yielding a progressively better SNR. At some point, the VGA3 and VGA2 gains drop sufficiently so that their noise becomes dominant, resulting in a slower reduction in SNR from that point. From the perspective of SNR alone, the maximum input level is reached when the VGA1 reaches its minimum gain.

Distortion must also be considered when maximizing the dynamic range. At low and moderate signal levels, the output distortion is constant and assumed to be adequate for the selected output level. At some point, the input signal becomes large enough that distortion at the input limits the system. This can be kept in check by monitoring peak detector voltage, VPK.

The most challenging scenario in terms of dynamic range is the presence of a large out-of-band blocker accompanying a weaker in-band wanted signal. In this case, the maximum input level is dictated by the blocker and its inclination to cause distortion. After filtering, the weak wanted signal must be amplified to the desired output level, possibly requiring the maximum gain on

VGA2 and VGA3. In such a case, both the distortion limits associated with the blocker at the input and the SNR limits created by the weaker signal and higher gains are present simultaneously. Furthermore, not only does the blocker scenario degrade the dynamic range, it also reduces the range of input signals that can be handled because a larger part of the gain range is simply used to extract the weak desired signal from the stronger blocker.

KEY PARAMETERS FOR QUADRATURE-BASED RECEIVERS

The majority of digital communication receivers make use of quadrature signaling, in which bits of information are encoded onto pairs of baseband signals that then modulate in-phase (I) and quadrature (Q) sinusoidal carriers. Both the baseband and modulated signals appear quite complex in the time domain with dramatic peaks and valleys. In a typical receiver, the goal is to recover the pair of quadrature baseband signals in the presence of noise and interfering signals after quadrature demodulation. In the process of filtering out-of-band noise and unwanted interferers and restoring the levels of the wanted I and Q baseband signals, it is critical to retain their gain and phase integrity over the bandwidth.

In filter mode, the [ADRF6518](#) delivers flat in-band gain and group delay, consistent with a six-pole Butterworth prototype filter, as described in the Programmable Filters section. Furthermore, careful design ensures excellent matching of these parameters between the I and Q channels. Although absolute gain flatness and group delay can be corrected with digital equalization, mismatch introduces quadrature errors and intersymbol interference that degrade bit error rates in digital communication systems.

For wideband signals, filters can be bypassed and the [ADRF6518](#) then becomes a dual cascaded chain of three VGAs, offering large gain range options, while maintaining gain and group delay match between the two channels.

APPLICATIONS INFORMATION

BASIC CONNECTIONS

Figure 72 shows the basic connections for a typical [ADRF6518](#) application.

SUPPLY DECOUPLING

Apply a nominal supply voltage of 3.3 V to the supply pins, VPS, VPI, and VPSD. The supply voltage must not exceed 3.45 V or drop below 3.15 V for VPS and VPSD. The supply voltage on VPI must not exceed 5.25 V. Decouple each supply pin to ground with at least one low inductance, surface-mount ceramic capacitor of 0.1 μF placed as close as possible to the [ADRF6518](#) device.

The [ADRF6518](#) has three separate supplies: two analog supplies and a digital supply. Take care to separate the analog and digital supplies with a large surface-mount inductor of 33 μH . Then decouple each supply separately to its respective ground through a 10 μF capacitor.

INPUT SIGNAL PATH

Each signal path has an input VGA, accessed through the INP1, INM1, INP2, and INM2 pins, that sets a differential input impedance of 400 Ω .

The inputs can be dc-coupled or ac-coupled. To ac couple the inputs, the user must pull the VICM/AC pin to ground. This provides an input common-mode voltage of $V_{\text{PI}}/2$. To dc couple the inputs, let the VICM pin float. If using direct dc coupling, the common-mode voltage, V_{CM} , can range from

1.35 V to 1.95 V while $V_{\text{PI}} = 3.3$ V. The user has the option of tying V_{PI} to a voltage up to 5 V. This provides a common-mode range of 1.35 V to 3.1 V. In general, the minimum input common-mode voltage is always 1.35 V, but the maximum common-mode voltage is $V_{\text{CM_MAX}} = 0.64 \times V_{\text{PI}} - 0.135$ V. The VICM pin can be used as a reference common-mode voltage for driving a high impedance sensing node of the preceding cascaded part (VICM has a 7.75 k Ω impedance).

OUTPUT SIGNAL PATH

The low impedance (10 Ω) output buffers are designed to drive a high impedance load, such as an ADC input or another amplifier stage. The output pins—OPP1, OPM1, OPP2, and OPM2—sit at a nominal output common-mode voltage of $V_{\text{PS}}/2$, but can be driven to a voltage of 0.9 V to $V_{\text{PS}} - 1.2$ V by applying the desired common-mode voltage to the high impedance VOXM pin.

DC OFFSET COMPENSATION LOOP ENABLED

When the dc offset compensation loop is enabled via B1 of the SPI register, the [ADRF6518](#) can null the output differential dc level. The loop is enabled by setting $B1 = 0$. The offset compensation loop creates a high-pass corner frequency, which is proportional to the value of the capacitors that are connected from the OFS1 and OFS2 pins to ground. For more information about setting the high-pass corner frequency, see the DC Offset Compensation Loop section.

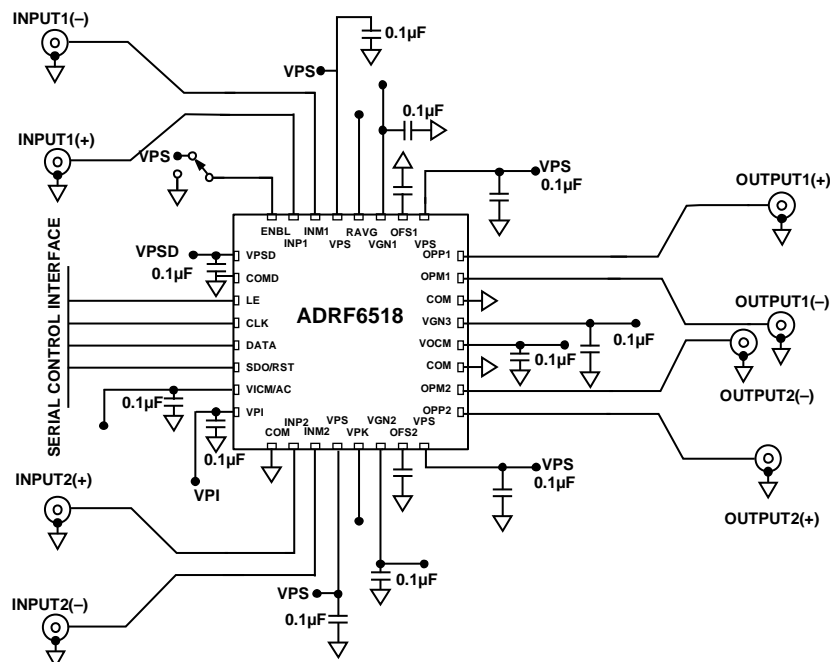

Figure 72. Basic Connections

11449-071

COMMON-MODE BYPASSING

Decouple the [ADRF6518](#) common-mode pins, VICM/AC and VOVM, to ground. Use at least one low inductance, surface-mount ceramic capacitor with a value of 0.1 μF to decouple the common-mode pins.

SERIAL PORT CONNECTIONS

The [ADRF6518](#) has a SPI port to control the gain and filter bandwidth settings. Data can be written to the internal 15-bit register and read from the register. It is recommended that low-pass RC filtering be placed on the SPI lines to filter out any high frequency glitches. See Figure 90, the evaluation board schematic, for an example of a low-pass RC filter.

ENABLE/DISABLE FUNCTION

To enable the [ADRF6518](#), pull the ENBL pin high. Driving the ENBL pin low disables the device, reducing current consumption to approximately 1 mA at room temperature. For the disable function to work properly, connect 10 k Ω pull-down resistors from the signal output pins (OPP1, OPM1, OPP2, OPM2) to ground to allow a dc path to ground for proper discharge (see Figure 67). If the disable function is not used, pull-down resistors are not necessary.

GAIN PIN DECOUPLING

The [ADRF6518](#) has three analog gain control pins: VGN1, VGN2, and VGN3. Use at least one low inductance, surface-mount ceramic capacitor with a value of 0.1 μF to decouple each gain control pin to ground.

PEAK DETECTOR CONNECTIONS

The [ADRF6518](#) has a peak detector output on the VPK pin, with a scaling of 1 V/V peak differential at filter inputs. The bigger peak of the two channels is reported. The peak detector time-constant can be changed with a resistor from the RAVG pin to VPS. Leave the RAVG pin open for the longest time-constant (hold time). The RAVG resistor range is ∞ to 1 k Ω .

To reset the peak detector, pull the SDO/RST pin high for 25 ns or longer. Logic levels are $V_{\text{LOW}} < 0.8 \text{ V}$, $V_{\text{HIGH}} > 2 \text{ V}$.

ERROR VECTOR MAGNITUDE (EVM) PERFORMANCE

Error vector magnitude (EVM) is a measure used to quantify the performance of a digital radio transmitter or receiver by measuring the fidelity of the digital signal transmitted or received. Various imperfections in the link, such as magnitude and phase imbalance, noise, and distortion, cause the constellation points to deviate from their ideal locations.

In general, a receiver exhibits three distinct EVM limitations vs. received input signal power. As signal power increases, the distortion components increase.

- At large enough signal levels, where the distortion components due to the harmonic nonlinearities in the device are falling in-band, EVM degrades as signal levels increase.
- At medium signal levels, where the signal chain behaves in a linear manner and the signal is well above any notable

noise contributions, EVM has a tendency to reach an optimal level determined dominantly by either the quadrature accuracy and IQ gain match of the signal chain or the precision of the test equipment.

- As signal levels decrease, such that noise is a major contributor, EVM performance vs. the signal level exhibits a decibel-for-decibel degradation with decreasing signal level. At these lower signal levels, where noise is the dominant limitation, decibel EVM is directly proportional to the SNR.

EVM TEST SETUP

The basic setup to test the EVM for the [ADRF6518](#) consisted of an Agilent MXG N5182B vector signal generator used as a signal source and an Agilent DSO7104B oscilloscope used to sample the signal while connected to a computer running Agilent 89600 vector signal analysis (VSA) software to calculate the EVM of the signal. The I and Q outputs of the [ADRF6518](#) were loaded with 400 Ω differential impedances and connected differentially to two [AD8130](#) amplifiers to convert the signals into single-ended signals. The single-ended signals were connected to the input channels of the vector signal analyzer.

EVM MEASUREMENT

EVM was measured for the [ADRF6518](#) only (the [AD8130](#) amplifiers were used, but their EVM contribution is minimal and do not dominate the measurement). The N5182B IQ baseband differential outputs drove the [ADRF6518](#) inputs through 1 μF coupling capacitors. Large coupling capacitors are necessary to keep the high-pass corner created by the capacitors as low as possible and to prevent the low-pass corner from corrupting the signal. The VICM/AC pin was grounded to enable ac coupling. The VPI pin was connected to 3.3 V by shorting it to VPS. The alpha of the pulse response filter was set to 0.35. The baseband input power to the [ADRF6518](#) was swept, and the analog gains were adjusted to maintain a target 1.5 V p-p differential signal level on both the I and Q outputs. The VGA1 analog gain was adjusted to limit its output to 1.5 V p-p (0.75 V peak on the peak detector output). The filter corner was set to 63 MHz, and the digital gains for VGA1, VGA2, VGA3, and the postamplifier were set to 15 dB, 21 dB, 21 dB, and 3 dB, respectively. Several signal bandwidths, signal types, gains, and output levels were tested, in filter mode and in filter bypass mode.

It is important to keep the high-pass corner of the output offset compensation loop low compared to the signal bandwidth. The lower the signal bandwidth is, the lower the user must set the high-pass corner to ensure that the minimal amount of the signal is not corrupted. See the Applications Information section of the [ADRF6510](#) and the [ADRF6516](#) data sheets for additional information on the effects of setting the high-pass corner too high in frequency.

It is also important to set the filter corner appropriately for the given signal bandwidth. The user must be careful not to set the filter corner too low in an attempt to achieve more rejection of

the out-of-band blockers, because this can corrupt the data in the signal and degrade the EVM. For examples of this, see the applications information section in the [ADRF6510](#) and the [ADRF6516](#) data sheets. Figure 83 also shows this trade-off between filter corner and signal bandwidth.

In Figure 73 through Figure 77, the x-axis is appropriately labeled in units of a voltage ratio, which is defined as

$$20 \times \log_{10}(x/1 \text{ V p-p})$$

where x is any number in units of V p-p.

This is done because the 100 Ω differential baseband source (Agilent MXG N5182B) drives the 400 Ω differential input impedance of the [ADRF6518](#). The standard unit of power ratio, dBm, is only applicable in a 50 Ω system.

Figure 73 and Figure 74 show EVM vs. input voltage over different symbol rates in filter mode (filter corner = 63 MHz) and in filter bypass mode, respectively. EVM is generally better for higher symbol rates while in filter bypass mode. This is mainly due to the absence of noise and distortion components that the filter introduces. For the same 80 MSPS signal, EVM improves 11 dB when switching from a 63 MHz filter corner to filter bypass mode. For the lower symbol rates, the difference in EVM between a 63 MHz filter corner and filter bypass mode is negligible.

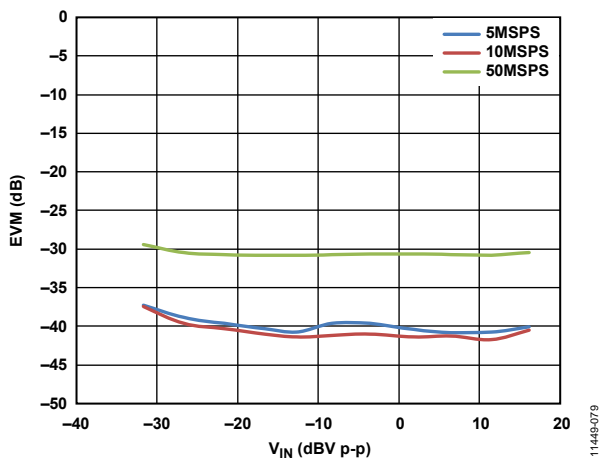

Figure 73. EVM vs. Input Voltage over Symbol Rates; Filter Corner = 63 MHz, QPSK, Gain Code = 0000000, 1.5 V p-p Differential Output Level Maintained

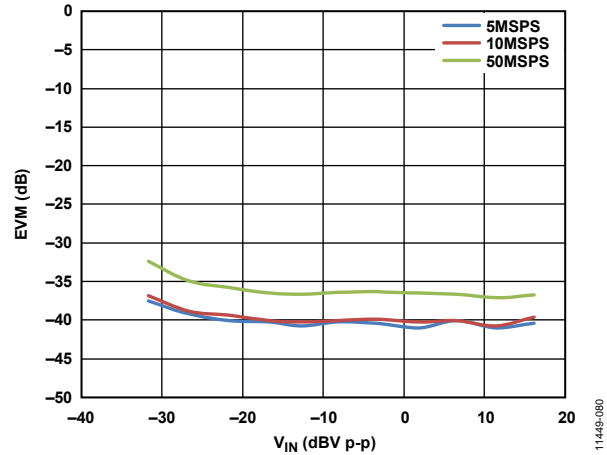

Figure 74. EVM vs. Input Voltage over Symbol Rates; Filter Bypass Mode, QPSK, Gain Code = 0000000, 1.5 V p-p Differential Output Level Maintained

Figure 75 and Figure 76 show EVM vs. input voltage over different modulation types at 50 MSPS in filter mode and in filter bypass mode, respectively. EVM improves for the high-order modulation types when the filter is in bypass mode.

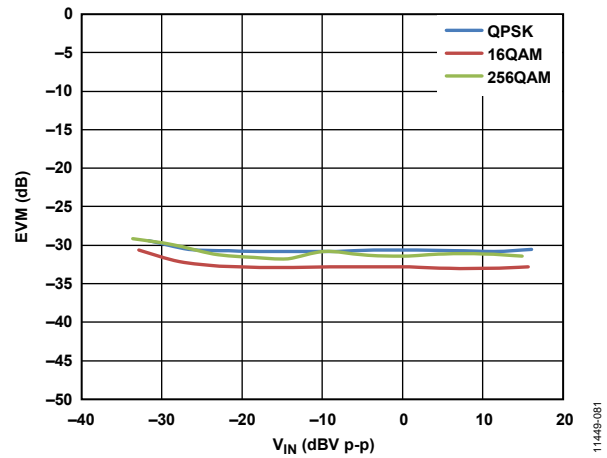

Figure 75. EVM vs. Input Voltage over Modulation Type; Filter Corner = 63 MHz, QPSK, 50 MSPS, Gain Code = 0000000, 1.5 V p-p Differential Output Level Maintained

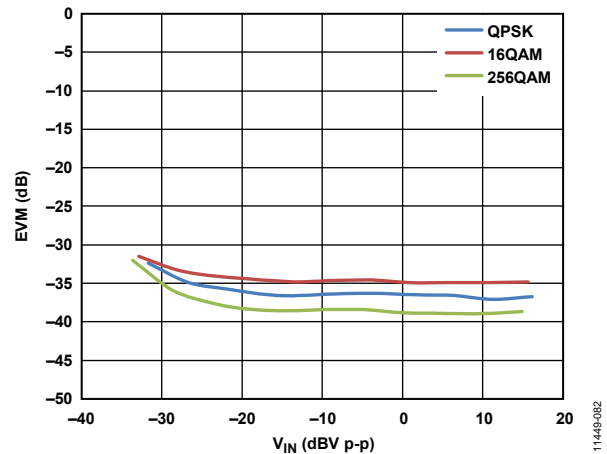

Figure 76. EVM vs. Input Voltage over Modulation Type; Filter Bypass Mode, QPSK, 50 MSPS, Gain Code = 0000000, 1.5 V p-p Differential Output Level Maintained

Figure 77 shows EVM vs. input voltage over various digital gain settings. There is about a 1 dB spread of EVM over the gain settings.

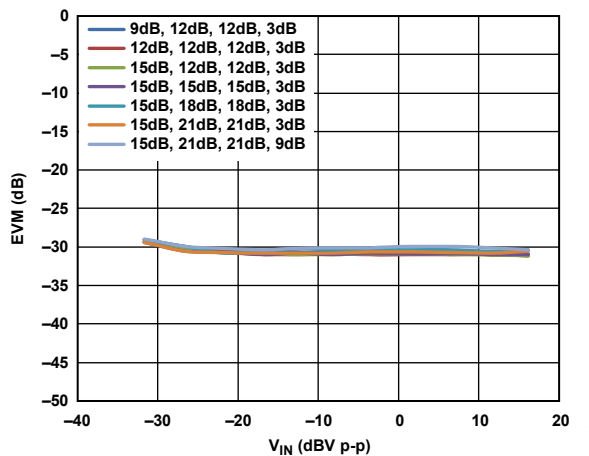

Figure 77. EVM vs. Input Voltage over Digital Gain Settings, Filter Corner = 63 MHz, QPSK, 50 MSPS, 1.5 V p-p Differential Output Level Maintained

EVM SYSTEM MEASUREMENT

An overall EVM measurement was completed with the ADL5380 IQ demodulator driving the ADRF6518. The interface between the two parts was dc-coupled. To achieve this, the VICM/AC pin was floated to enable dc coupling mode and the VPI pin on the ADRF6518 was connected to 5 V to accommodate the 3.1 V output common-mode voltage of the ADL5380. The RF carrier frequency applied to the RF input of the ADL5380 and the LO frequency were set to 900 MHz, creating a zero intermediate frequency (I/F). The alpha of the pulse response filter was set to 0.35. The RF input power to the ADL5380 was swept, and the analog gains on the ADRF6518 were adjusted to maintain a target 1.5 V p-p differential signal level on both the I and Q outputs. The VGA1 analog gain was adjusted to limit its output to 1.5 V p-p (0.75 V peak on the peak detector output). The filter corner was set to 63 MHz, and digital gains for VGA1, VGA2, VGA3, and the postamplifier were set to 15 dB, 21 dB, 21 dB, and 3 dB, respectively. Several signal bandwidths, signal types, gains, and output levels were tested, in filter mode and in filter bypass mode.

Figure 78 shows three different symbol rates: 10 MSPS, 50 MSPS, and 80 MSPS, with the filter enabled. There is a degradation of EVM with increasing symbol rate, but at 10 MSPS, the system achieves better than -40 dB of EVM for about 50 dB of the input power range. The degradation of EVM at the high input power for Figure 78 to Figure 83 is caused by the ADL5380 compressing. By placing an RF attenuator in front of the ADL5380, the user can extend the dynamic range of the system.

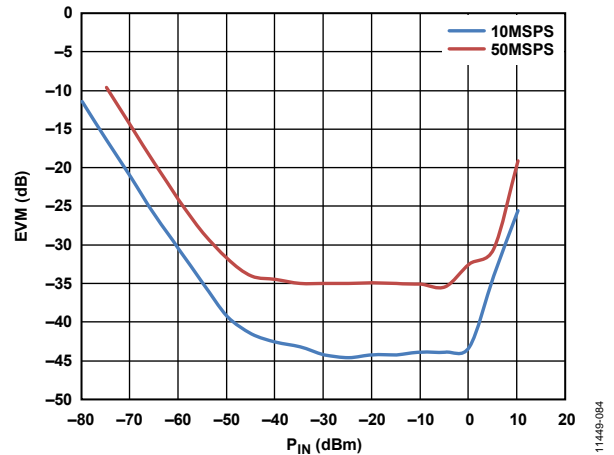

Figure 78. EVM vs. Input Power Over Symbol Rate; QPSK, Filter Corner = 63 MHz, Gain Code = 0000000, 1.5 V p-p Differential Output Level Maintained

Figure 79 shows four different symbol rates, with the filter in bypass mode. EVM generally improves while in filter bypass mode, especially at the higher symbol rates, due to the absence of noise, IQ gain mismatch, IQ phase mismatch, raw group delay, and group delay mismatch, which are some dominant sources of error that the filter adds when enabled.

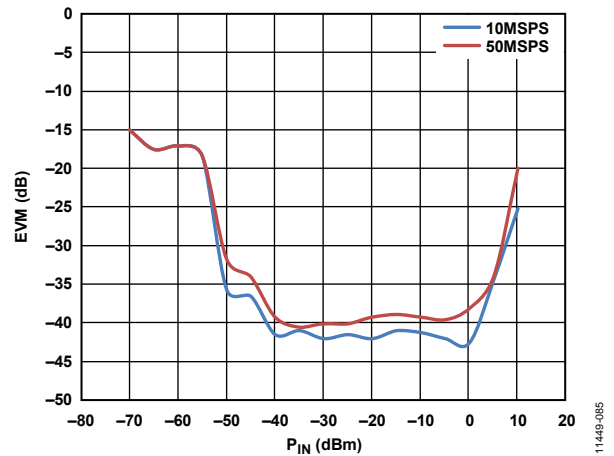

Figure 79. EVM vs. Input Power over Symbol Rate; Filter Bypass Mode, Gain Code = 0000000, 1.5 V p-p Differential Output Level Maintained

Figure 80 shows the EVM for a 50 MSPS signal over several different digital modulation types while the filter is in bypass mode. Up to 256 QAM, there is an improvement to EVM, but this is due to how EVM is calculated, rather than absolute symbol error being reduced. (EVM is calculated as the ratio of the rms power of the symbol error vector to the rms average power of the constellation. A similar and perhaps better metric is modulation error ratio, or MER, which is defined as the ratio of the rms power of the ideal symbol to the rms power of the symbol error vector.) The 1024 QAM signal starts to degrade due to the noise and distortion components impacting the closely packed symbols in the constellation.

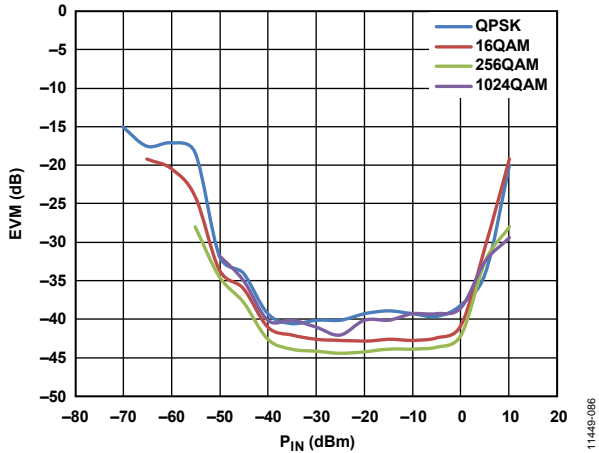

Figure 80. EVM vs. Input Power over Digital Modulation Type; Filter Bypass Mode, Gain Code = 0000000, 1.5 V p-p Differential Output Level Maintained

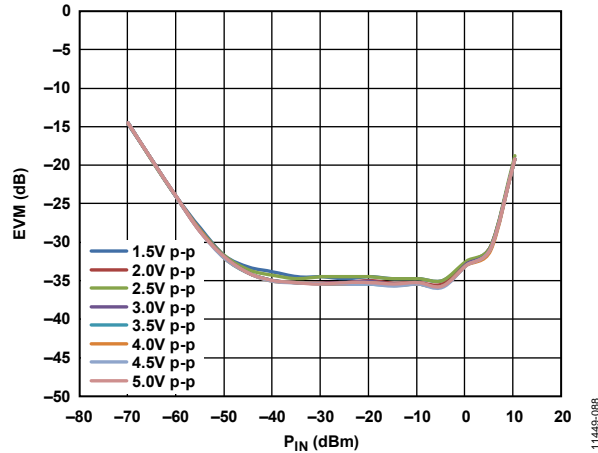

Figure 82. EVM vs. Input Power over Output Level; Filter Corner = 63 MHz, QPSK, 50 MSPS, Gain Code = 0000000

Figure 81 shows the same four modulation types as in Figure 80, but with the filter enabled. EVM is generally degraded due to filter noise, as described in the Noise Characteristics section.

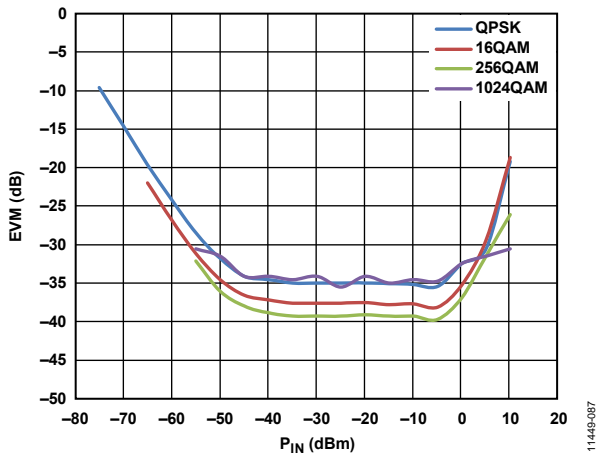

Figure 81. EVM vs. Input Power over Digital Modulation Type; Filter Corner = 63 MHz, Gain Code = 0000000, 1.5 V p-p Differential Output Level Maintained

Figure 82 shows a sweep over several output setpoints, from 1.5 V p-p to 5.0 V p-p. EVM only changes by a couple of decibels for the full output range tested, which gives the user flexibility in determining the level at which the output signal is maintained. Although not shown in Figure 82, signals slightly bigger than 5 V p-p have drastically degraded EVM, and loss of lock can occur easily.

Figure 83 shows the EVM for several different digital gain settings. There is an approximate 2 dB to 3 dB of EVM degradation at the following gain settings: VGA1 = 9 dB, VGA2 = 12 dB, VGA3 = 12 dB, and postamplifier = 3 dB. This is due to the noise figure of the ADRF6518 increasing with the lower gain setting of VGA1 (VGA1 sets the noise figure for the part). This correlation is shown in Figure 23, which shows about a 2 dB increase in noise figure when the VGA1 digital gain is changed from 15 dB to 9 dB.

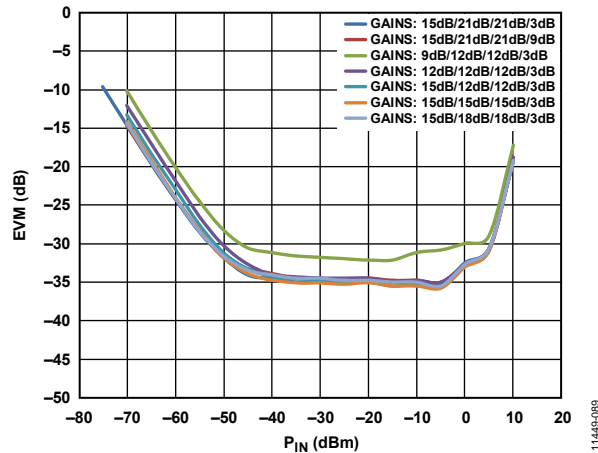

Figure 83. EVM vs. Input Power over Gain Code; Filter Mode = 63 MHz, QPSK, 50 MSPS, 1.5 V p-p Differential Output Level Maintained

EFFECT OF FILTER BW ON EVM

Figure 84 shows how changing the filter BW affects the EVM for signals at several different symbol rates. The x-axis is normalized such that it displays the baseband bandwidth of each respective signal to the set filter corner. For example, a filter corner of 10 MHz and a signal with a baseband bandwidth of 5 MHz yields 2 Hz/Hz. Similarly, a filter corner of 50 MHz and a signal with a baseband bandwidth of 25 MHz also yields 2 Hz/Hz. Baseband bandwidth is defined by the following:

$$BW_{BB} = \frac{(Symbol\ Rate) \times (1 + \alpha)}{2}$$

The general behavior shows that the higher the ratio of the filter corner to baseband bandwidth is, the better the EVM. This behavior starts to plateau at around a 2x ratio. This behavior affects the higher bandwidth signal more so than the smaller bandwidth signals. The primary reason for this behavior is that the noise is not flat across frequency (there is some interaction between the filters and all the gain stages). The noise shaping degrades EVM as the filter corner starts to encroach well outside of the signal bandwidth.

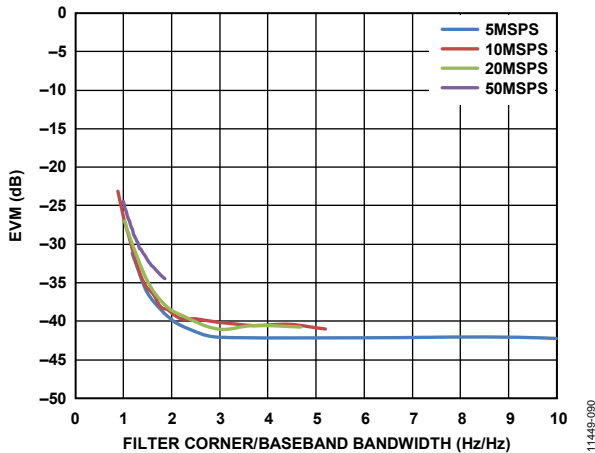

Figure 84. EVM vs. Filter Corner/Baseband BW Ratio over Symbol Rate, Filter Corner = 63 MHz, QPSK, 1.5 V p-p Output Level, -20 dBm Input Power

PULL-DOWN RESISTORS FOR DISABLE FUNCTION

The ADRF6518 offers a disable function, by pulling ENBL low, that brings the supply current to approximately 1 mA. For the function to work correctly, a dc path to ground must be established on the output pins (OPP1, OPM1, OPP2, OPM2) to allow proper discharge of the postamplifier. Figure 85 shows how to properly place the pull-down resistors. The resistor value must be big enough so that it does not interfere with the output impedance that the postamplifier sees (for example, 400 Ω), but not so big that it prevents proper discharge, effectively becoming an open circuit. For most applications, a value of R_{PULLDOWN} = 10 kΩ sufficiently satisfies these conditions.

INSTABILITY AT HIGH GAIN IN FILTER BYPASS MODE

The user must be cautious while operating the ADRF6518 at the highest of gains in filter bypass mode. Due to the high gain (up to 66 dB) and wide bandwidth (up to 350 MHz with maximum digital gains), the ADRF6518 is susceptible to oscillations when it is in filter bypass mode and its gain is set above 60 dB. The oscillation manifests itself with a broadband rise in the noise floor and significantly degrades the SNR and EVM. Orthogonal input to output signal paths on the printed circuit board (PCB) helps reduce this oscillation. This can be seen in the top layer silkscreen, shown in Figure 92. It is recommended that any posts or headers not be placed for measurement purposes on the signal paths, especially the output signal paths. Doing so causes the output signal to radiate back to the input and induce the oscillation at even lower gains than 60 dB.

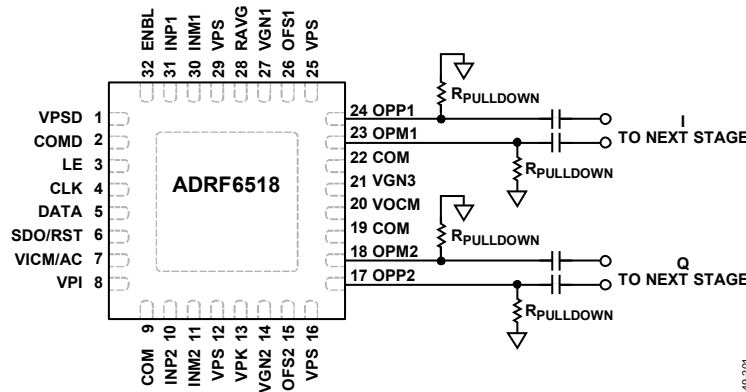

Figure 85. Pull-Down Resistors

INSTABILITY AT LOW FILTER CORNERS AND LOW POWER MODE

The ADRF6518 has a tendency to oscillate when the filter corner is 8 MHz or less and when in low power mode. This oscillation is primarily out of band, occurring at approximately 1.2 GHz. The oscillation worsens at cold temperatures. It is recommended that high power mode be used when in filter mode to lessen the inherent instability of the device. A low-pass filter can be added between the output of the ADRF6518 and the following stage to attenuate the out of band oscillation.

PEAK DETECTOR BANDWIDTH AND SLEW RATE

The VPK pin on the ADRF6518 has an attack bandwidth of 100 MHz, where the VPK pin is responding to a rise in signal level, and a droop slew rate, where VPK is responding to a fall in signal level; this can be seen in Figure 47, where very large values of the off-chip R_{AVG} were used. R_{AVG} controls the slew rate of the peak detector. This resistor must be connected from the VPK pin to the VPS pin.

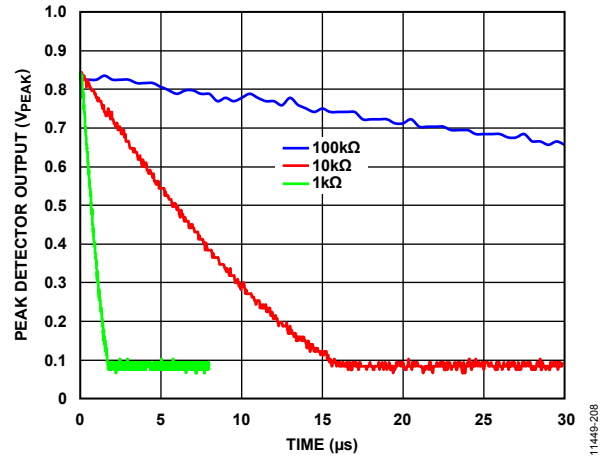

Figure 87. Peak Detector Droop time over R_{AVG} , zoomed

Figure 86 and Figure 87 show the slew rate for three different values of R_{AVG} : 100 k Ω , 10 k Ω , and 1 k Ω , with slew rates of 5 mV/ μ s, 50 mV/ μ s, 500 mV/ μ s, respectively. Note that these slew rates start to decrease as the peak detector nears its minimum value. This is a result of the nonlinearities of the output stage of the peak detector.

LINEAR OPERATION OF THE ADRF6518

The ADRF6518 has multiple stages per channel. Each stage can independently be driven into compression depending on the gain settings and input signal level. There is only access to the input stages (INP1/INM1, INP2/INM2) and the output stages (OPP1/OPM2, OPP2/OPM2); therefore, the user must infer the signal level at the input and output of each stage from the device under test (DUT) input signal level and the gain settings, both analog and digital. The maximum recommended signal levels are shown in Figure 90. All signal levels are in V p-p differential.

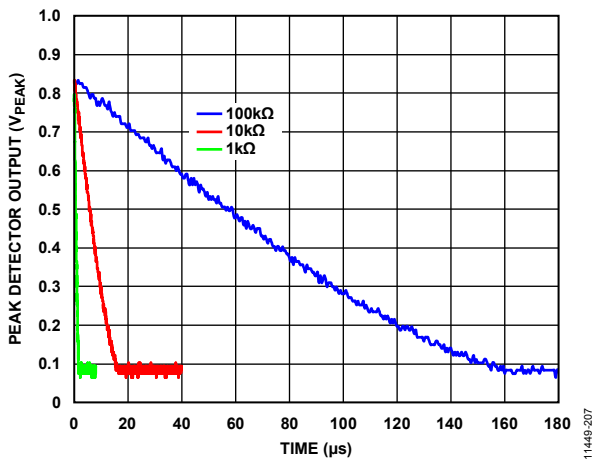

Figure 86. Peak Detector Droop time over R_{AVG}

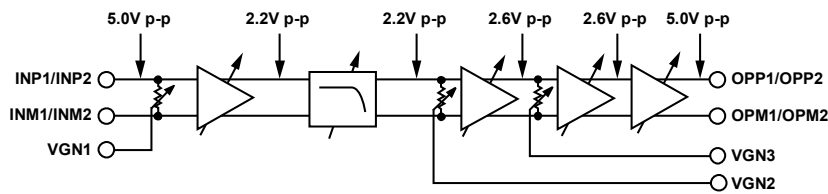

Figure 88. Maximum Signal Levels; Single Channel Shown

EVALUATION BOARD

An evaluation board is available for testing the [ADRF6518](#).

EVALUATION BOARD CONTROL SOFTWARE

The [ADRF6518](#) evaluation board is controlled through the USB port on a PC. This software enables/disables the dc offset compensation loop and controls the filter corner frequency, the high and low power modes, and the minimum and maximum gains for each amplifier in the [ADRF6518](#). For information about the register map, see Table 5. For information about SPI port timing and control, see Figure 2 and Figure 3.

After the software is downloaded and installed, start the basic user interface to program the filter corner and gain values (see Figure 89).

To program the filter corner, perform one of the following:

- Click the arrow in the **Frequency Corner MHz** section of the window, select the desired corner frequency from the menu, and click **Write Selected Cutoff Frequency to Device**.
- Click **Frequency +1 MHz** or **Frequency -1 MHz** to increment or decrement the frequency corner in 1 MHz steps from the current frequency corner.

To program the filter mode, offset correction, and power mode, move the respective slider switch in the upper right corner of the window.

To program the maximum gains of VGA1, VGA2, VGA3, and the postamplifier, click the **VGA1 Gain dB**, **VGA2 Gain dB**, **VGA3 Gain dB**, and **Post Amp Gain dB** drop-down boxes and select the desired gain.

- The VGA1 maximum gain can be set to 9 dB, 12 dB, or 15 dB.
- The VGA2 and VGA3 maximum gain can be set to 12 dB, 15 dB, 18 dB, or 21 dB.
- The postamplifier maximum gain can be set to 3 dB or 9 dB.

When the user clicks the **Write Selected Cutoff Frequency to Device** button, a write operation is executed, immediately followed by a read operation. The updated information is displayed in the **VGA1 Gain dB**, **Filter Corner MHz**, **VGA2 Gain dB**, **VGA3 Gain dB**, and **Post Amp Gain dB** fields.

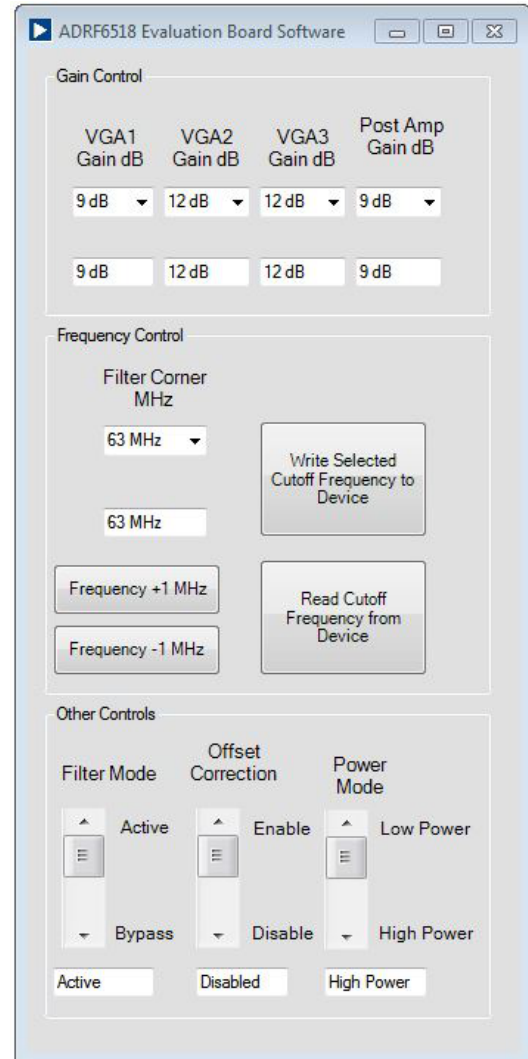

Figure 89. Analog Devices [ADRF6518](#) Evaluation Software

SCHEMATICS AND ARTWORK

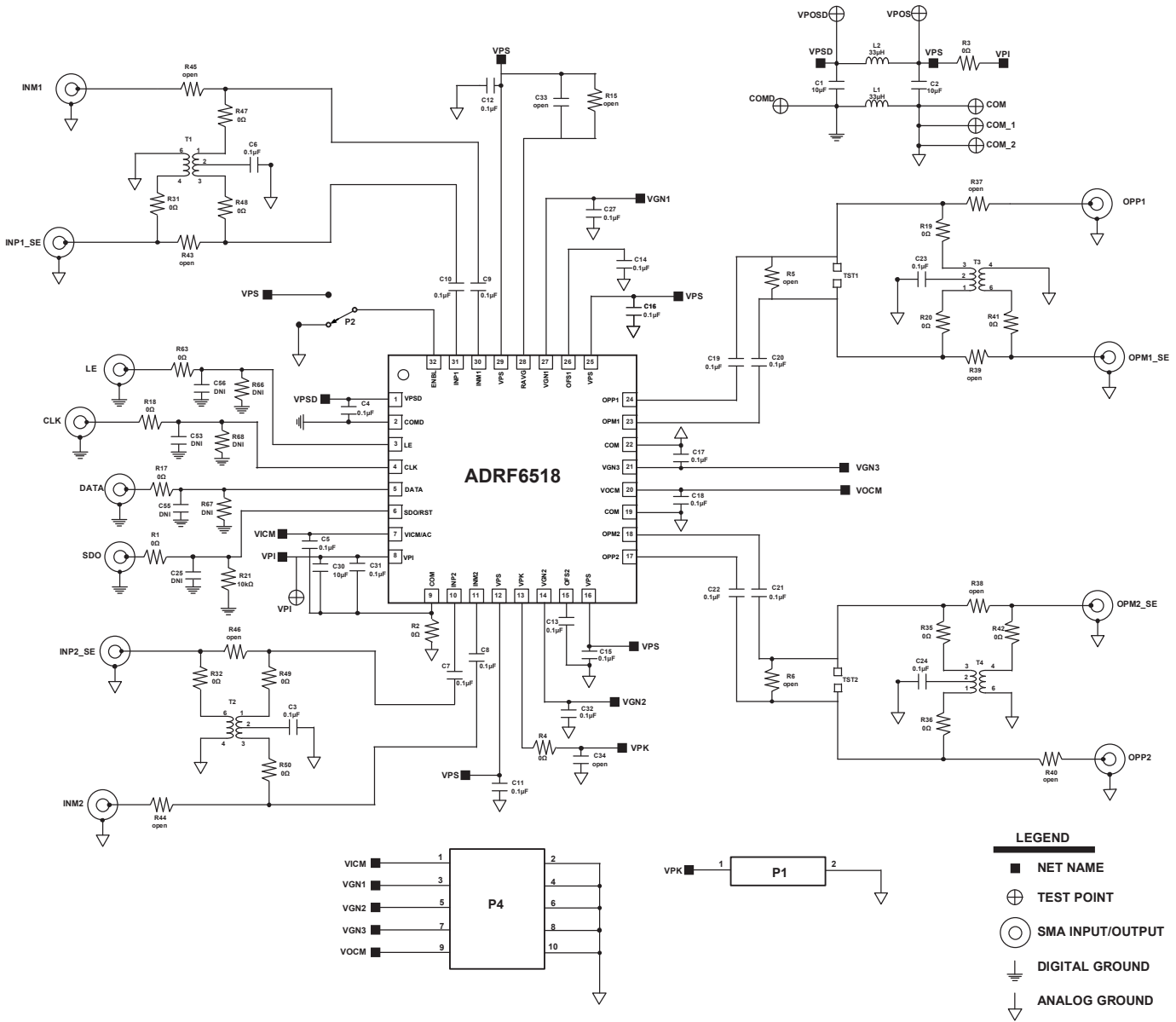

Figure 90. Evaluation Board Schematic

11449-073

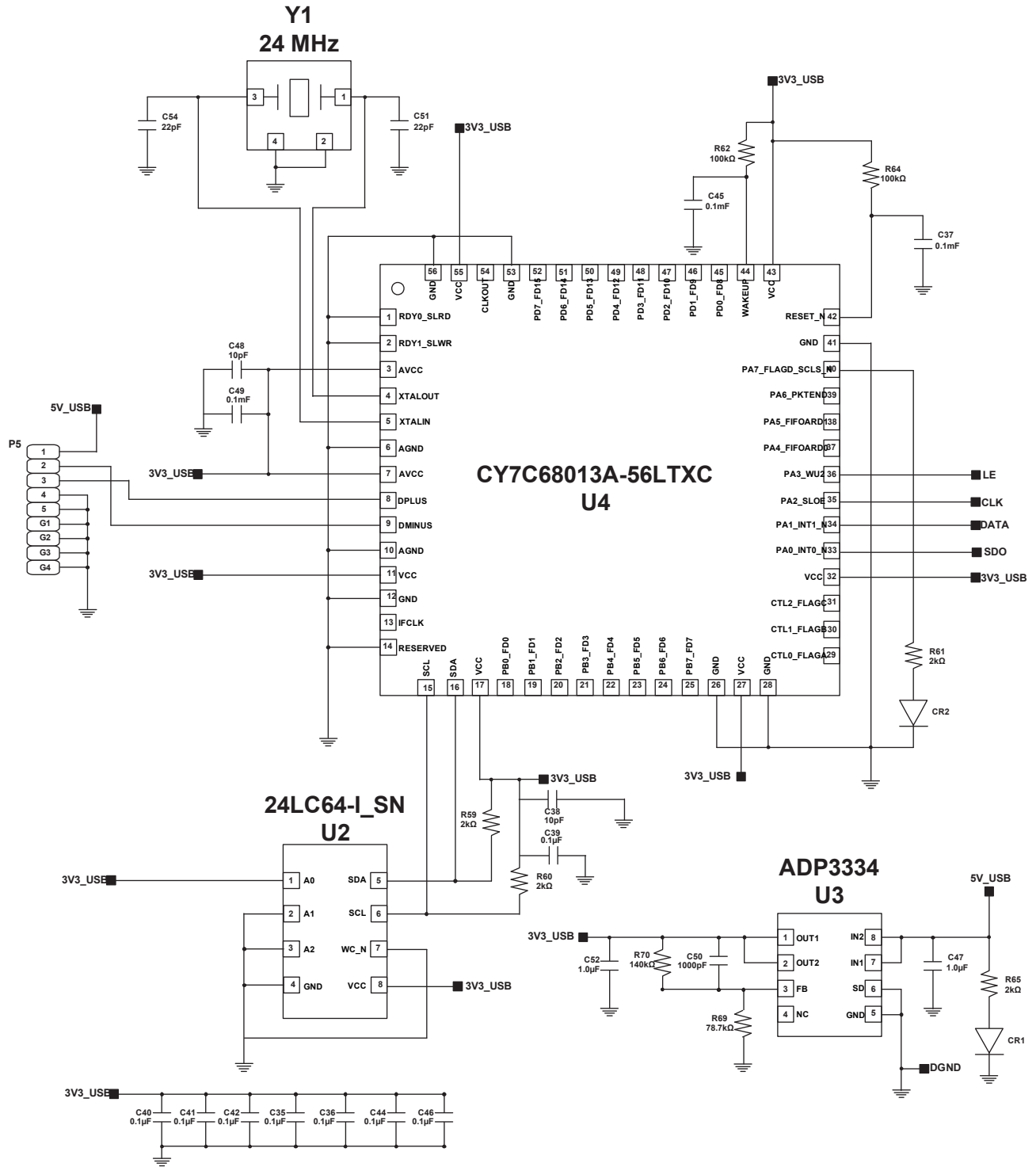
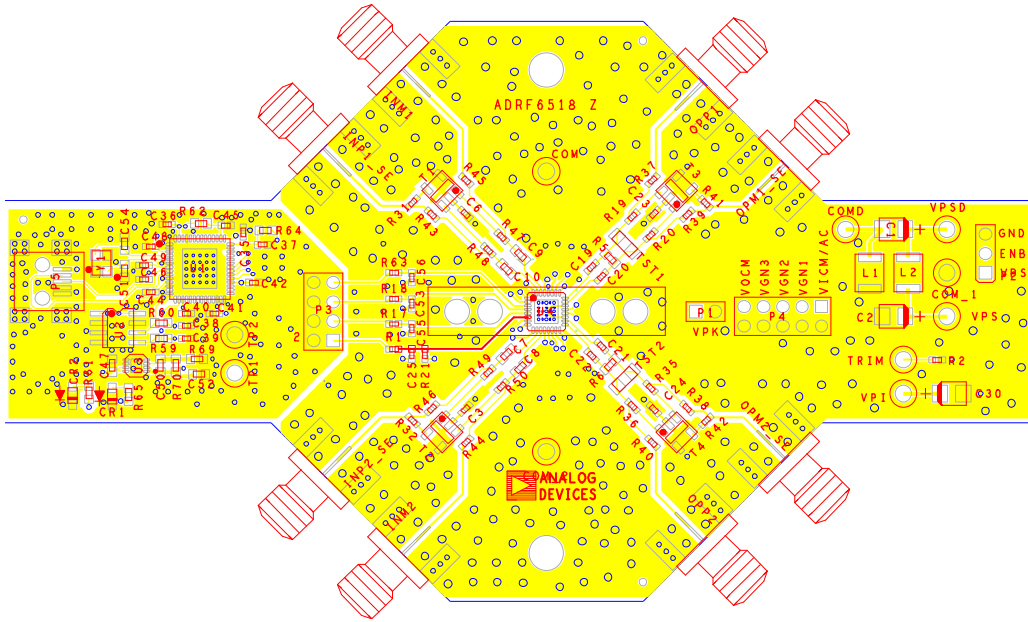

Figure 91. USB Evaluation Board Schematic

11449-074



11449-075

Figure 92. Top Layer Silkscreen

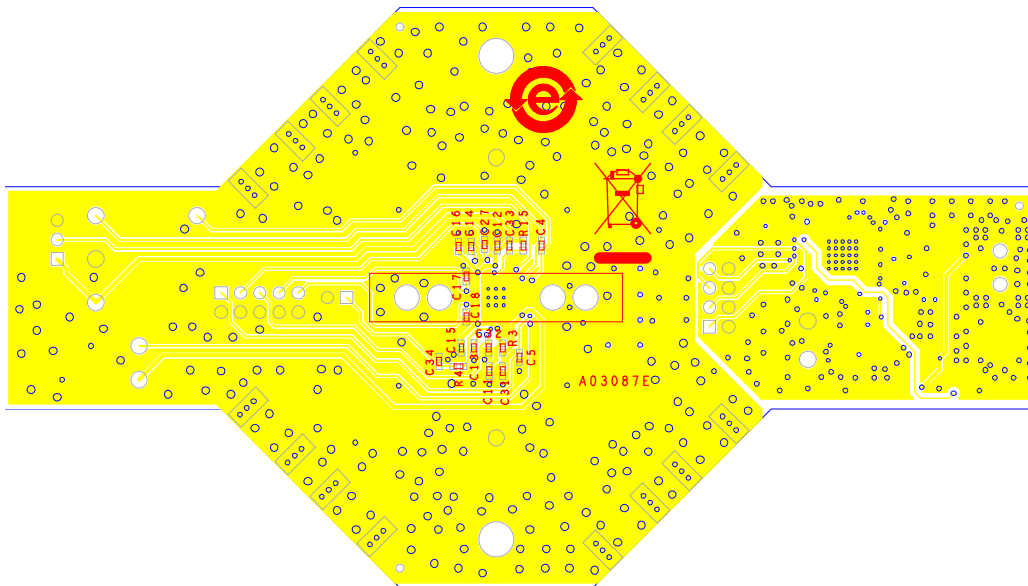

11449-076

Figure 93. Component Side Layout

Table 6. Evaluation Board Configuration Options

Components	Function	Default Conditions
C1, C2, C4, C11, C12, C15, C16, C30, C31, L1, L2, R2, R3, P4	Power supply and ground decoupling. Nominal supply decoupling consists of a 0.1 μF capacitor to ground.	C1, C2, C30 = 10 μF (Size 1210) C4, C11, C12, C15, C16, and C31 = 0.1 μF (Size 0402) L1, L2 = 33 μH (Size 1812) R2, R3 = 0 Ω (Size 0402) P4 = installed
T1, T2, C3, C6, C7 to C10, R31, R32, R43, R44, R45, R46, R47, R48, R49, R50	Input interface. The INP1_SE, INM1, INP2_SE, and INM2 input SMAs are used to drive the part differentially by bypassing the baluns. Using only INP1_SE and INP2_SE in conjunction with the baluns enables single-ended operation. The default configuration of the evaluation board is for single-ended operation. T1 and T2 are 8:1 impedance ratio baluns that transform a single-ended signal in a 50 Ω system into a balanced differential signal in a 400 Ω system. R31, R32, R47, R48, R49, and R50 are populated for appropriate balun interface To bypass the T1 and T2 baluns for differential interfacing, remove the balun interfacing resistors, R31, R32, R47, R48, R49, and R50, and populate R43, R44, R45, and R46 with 0 Ω resistors.	T1, T2 = Pulse Electronics CX2049LNL C3, C6 = 0.1 μF (Size 0402) C7 to C10 = 0.1 μF (Size 0602) R31, R32, R47 to R50 = 0 Ω (Size 0402) R43 to R46 = open (Size 0402)
T3, T4, C19 to C24, R5, R6, R19, R20, R35 to R42	Output interface. The OPP1, OPM1_SE, OPP2, and OPM2_SE output SMAs are used to obtain differential signals from the part when the output baluns are bypassed. Using OPM1_SE, OPM2_SE, and the baluns, the user can obtain single-ended output signals. The default configuration of the evaluation board is for single-ended operation. T3 and T4 are 8:1 impedance ratio baluns that transform a differential signal in a 400 Ω system into a single-ended signal in a 50 Ω system. To bypass the T3 and T4 baluns for differential interfacing, remove the balun interfacing resistors, R19, R20, R35, R36, R41, and R42, and populate R37, R38, R39, and R40 with 0 Ω resistors. R5 and R6 can be populated with an impedance of at least 400 Ω to terminate the output in differential applications.	T3, T4 = Pulse Electronics CX2049LNL C19 to C24 = 0.1 μF (Size 0402) R5, R6 = open (size 0402) R19, R20, R35, R36, R41, R42 = 0 Ω (Size 0402) R37 to R40 = open (Size 0402)
P2	Enable interface. The ADRF6518 is powered up by applying a logic high voltage to the ENBL pin (Jumper P2 is connected to VPS).	P2 = installed for enable
P3, R1, R17, R18, R21, R63, C25, C53, C55, C56	Serial control interface. The digital interface sets the corner frequency, VGA1/VGA2/VGA3 maximum gains, and the postamplifier maximum gain using the serial interface via the LE, CLK, DATA, and SDO pins. RC filter networks can be populated on the CLK, LE, and DATA lines to filter the SPI signals. CLK, DATA, and LE signals can be observed via P3 for debug purposes. Setting C25, C53, and C56 = 330 pF is recommending for filtering.	P3 = installed R1 = 0 Ω (Size 0402) R21 = 10 k Ω (Size 0402) C25, C53, C55, C56 = open (Size 0402) R17, R18, R63 = 1 k Ω (Size 0402)
C13, C14	DC offset compensation loop. The dc offset compensation loop is enabled via the SPI port. When enabled, the C13 and C14 capacitors are connected to circuit common. The high-pass corner frequency is expressed as follows: $f_{HP} \text{ (Hz)} = 6.7 \times (\text{Post Filter Linear Gain} / C_{OFS} \text{ (}\mu\text{F)})$	C13, C14 = 0.1 μF (Size 0402)
C5	Input common-mode reference. The input common-mode voltage can be monitored at the VICM pin. If the VICM pin is left open, an input common-mode voltage must be supplied externally (DC coupling mode). If VICM pin is connected to ground, the input common-mode defaults to VPI/2 (ac coupling mode).	C5 = 0.1 μF (Size 0402)
C18	Output common-mode setpoint. The output common-mode voltage can be set externally when applied to the VOVM pin. If the VOVM pin is left open, the output common-mode voltage defaults to VPS/2.	C18 = 0.1 μF (Size 0402)
C17, C27, C32	Analog gain control. The range of the analog gain pins, VGN1, VGN2, and VGN3, is from 0 V to 1 V, creating a gain scaling of 30 mV/dB.	C17, C27, C32 = 0.1 μF (Size 0402)
P1, R4, R15, C33, C34	Peak detector.	P1 = installed

Components	Function	Default Conditions
		R4 = 0 Ω (Size 0402) R15, C33, C34 = open (Size 0402)
U2, U3, U4, P5	Cypress microcontroller, EEPROM, and LDO.	U2 = Microchip MICRO24LC64 U3 = Analog Devices ADP3334ACPZ U4 = Cypress Semiconductor CY7C68013A-56LTXC P5 = Mini USB connector
C35, C36, C40, C41, C42, C44, C46	3.3 V supply decoupling. Several capacitors are used for decoupling on the 3.3 V supply.	C35, C36, C40, C41, C42, C44, C46 = 0.1 μ F (0402)
C37, C38, C39, C45, C48, C49, R59, R60, R61, R62, R64, CR2	Cypress and EEPROM components.	C38, C48 = 10 pF (0402) C37, C39, C45, C49 = 0.1 μ F (0402) R59, R60, R61 = 2 k Ω (0402) R62, R64 = 100 k Ω (0402) CR2 = ROHM SML-21OMTT86
C47, C50, C52, R65, R69, R70, CR1	LDO components.	C47, C52 = 1 μ F (0402) C50 = 1000 pF (0402) R65 = 2 k Ω (0402) R69 = 78.7 k Ω (0402) R70 = 140 k Ω (0402) CR1 = ROHM SML-21OMTT86
Y1, C51, C54	Crystal oscillator and components. 24 MHz crystal oscillator.	Y1 = NDK NX32255A-24MHz C51, C54 = 22 pF (0402)