

FEATURES

- isoPower* integrated, isolated dc-to-dc converter
- Regulated 3.135 V to 5.25 V output
- Up to 150 mW output power
- Dual dc-to-100 Mbps (NRZ) signal isolation channels
- Soft start power supply
- 20-lead SSOP package with 5.3 mm creepage
- Supports SPI up to 15 MHz
- High temperature operation: 105°C
- High common-mode transient immunity: >25 kV/μs
- Safety and regulatory approvals
 - UL recognition
 - 3750 V rms for 1 minute per UL 1577
 - CSA Component Acceptance Notice 5A
 - VDE certificate of conformity
 - DIN V VDE V 0884-10 (VDE V 0884-10):2006-12
 - $V_{IORM} = 849$ V peak

APPLICATIONS

- RS-232 transceivers
- Power supply start-up bias and gate drives
- Isolated sensor interfaces
- Industrial PLCs

GENERAL DESCRIPTION

The ADuM6210/ADuM6211/ADuM6212¹ are dual-channel digital isolators with *isoPower*®, an integrated, isolated dc-to-dc converter. Based on the Analog Devices, Inc., *iCoupler*® technology, the dc-to-dc converter provides regulated, isolated power that is adjustable between 3.135 V and 5.25 V. Input supply voltages can range from slightly below the required output to significantly higher. Popular voltage combinations and their associated power levels are shown in Table 2.

The ADuM6210/ADuM6211/ADuM6212 eliminate the need for a separate, isolated dc-to-dc converter in low power, isolated designs. The *iCoupler* chip-scale transformer technology is used for isolated logic signals and for the magnetic components of the dc-to-dc converter. The result is a small form factor, total isolation solution.

isoPower uses high frequency switching elements to transfer power through its transformer. Take special care during printed circuit board (PCB) layout to meet emissions standards. See the AN-0971 [Application Note](#) for board layout recommendations.

¹ Protected by U.S. Patents 5,952,849; 6,873,065; 6,903,578; and 7,075,329. Other patents are pending.

Rev. D

Document Feedback

Information furnished by Analog Devices is believed to be accurate and reliable. However, no responsibility is assumed by Analog Devices for its use, nor for any infringements of patents or other rights of third parties that may result from its use. Specifications subject to change without notice. No license is granted by implication or otherwise under any patent or patent rights of Analog Devices. Trademarks and registered trademarks are the property of their respective owners.

FUNCTIONAL BLOCK DIAGRAM

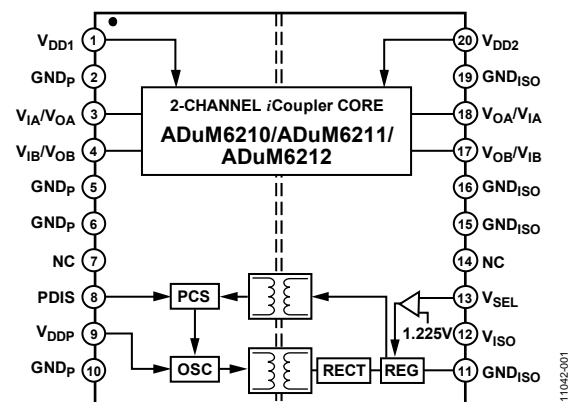

Figure 1. ADuM6210/ADuM6211/ADuM6212

Table 1. Data I/O Port Assignments

Channel	Pin	ADuM6210	ADuM6211	ADuM6212
V _{IA} /V _{IA}	3	V _{IA}	V _{OA}	V _{OA}
V _{IB} /V _{OB}	4	V _{IB}	V _{IB}	V _{OB}
V _{OA} /V _{IA}	18	V _{OA}	V _{IA}	V _{IA}
V _{OB} /V _{IB}	17	V _{OB}	V _{OB}	V _{IB}

Table 2. Power Levels

Input Voltage (V)	Output Voltage (V)	Output Power (mW)
5	5	150
5	3.3	100
3.3	3.3	66

TABLE OF CONTENTS

Features	1
Applications.....	1
Functional Block Diagram	1
General Description	1
Revision History	2
Specifications.....	3
Electrical Characteristics—5 V Primary Input Supply/5 V Secondary Isolated Supply	3
Electrical Characteristics—3.3 V Primary Input Supply/3.3 V Secondary Isolated Supply	5
Electrical Characteristics—5 V Primary Input Supply/3.3 V Secondary Isolated Supply	7
Package Characteristics	9
Regulatory Approvals.....	9
Insulation and Safety-Related Specifications.....	9
DIN V VDE V 0884-10 (VDE V 0884-10) Insulation Characteristics	10

REVISION HISTORY

3/2019—Rev. C to Rev. D

Change to Features Section	1
Changes to Electrical Characteristics—3.3 V Primary Input Supply/3.3 V Secondary Isolated Supply Section, Setpoint Parameter, Line Regulation Parameter, and Output Supply Parameter, Table 7.....	5
Changes to Electrical Characteristics—5 V Primary Input Supply/3.3 V Secondary Isolated Supply Section, Setpoint Parameter, and Output Supply Parameter, Table 11	7
Changes to V_{DDP} at $V_{ISO} = 3.135\text{ V}$ to 3.6 V Parameter and V_{DD1} , V_{DD2} Parameter, Table 19	10
Changes to Table 22.....	12
Changes to Table 23.....	13
Changes to Table 24.....	14
Change to Applications Information Section	19

7/2018—Rev. B to Rev. C

Change to Figure 1	1
Changes to Setpoint Parameter, Output Supply Parameter, Efficiency at $I_{ISO(MAX)}$ Parameter, and I_{DDP} , Full V_{ISO} Load Parameter, Table 3, and Propagation Delay Parameter, C Grade, Table 5	3
Changes to Logic High Output Voltages Parameter, Logic Low Output Voltages Parameter, Positive Going Threshold Parameter, and Negative Going Threshold Parameter, Table 6.....	4

Recommended Operating Conditions	10
Absolute Maximum Ratings	11
ESD Caution.....	11
Pin Configurations and Function Descriptions	12
Truth Tables.....	15
Typical Performance Characteristics	16
Applications Information	19
PCB Layout	19
Thermal Analysis	20
Propagation Delay Parameters	20
EMI Considerations	20
DC Correctness and Magnetic Field Immunity.....	20
Power Consumption	21
Insulation Lifetime	22
Outline Dimensions	23
Ordering Guide	23

Changes to Setpoint Parameter, Output Supply Parameter, Efficiency at $I_{ISO(MAX)}$ Parameter, and I_{DDP} , Full V_{ISO} Load Parameter, Table 7, and Propagation Delay Parameter, C Grade, Table 9	5
Changes to Logic High Output Voltages Parameter, Logic Low Output Voltages Parameter, Positive Going Threshold Parameter, and Negative Going Threshold Parameter, Table 10.....	6
Changes to Setpoint Parameter, Output Supply Parameter, Efficiency at $I_{ISO(MAX)}$ Parameter, and I_{DDP} , Full V_{ISO} Load Parameter, Table 11, and Propagation Delay Parameter, C Grade, Table 13	7
Changes to Logic High Output Voltages Parameter, Logic Low Output Voltages Parameter, Positive Going Threshold Parameter, and Negative Going Threshold Parameter, Table 14.....	8
9/2016—Rev. A to Rev. B	
Changes to Features Section and Table 1	1
Changes to Table 16	9
Changes to Equation 1	19

5/2013—Rev. 0 to Rev. A

Added Table 1, Renumbered Sequentially	1
Changes to Table 3.....	3
Changes to Figure 22 and Figure 23.....	18

1/2013—Revision 0: Initial Version

SPECIFICATIONS

ELECTRICAL CHARACTERISTICS—5 V PRIMARY INPUT SUPPLY/5 V SECONDARY ISOLATED SUPPLY

All typical specifications are at $T_A = 25^\circ\text{C}$, $V_{DD1} = V_{DD2} = V_{DDP} = 5\text{ V}$, V_{SEL} resistor network: $R_1 = 10\text{ k}\Omega$, $R_2 = 30.9\text{ k}\Omega$ between V_{ISO} and GND_{ISO} . Minimum/maximum specifications apply over the entire recommended operation range, which is $4.5\text{ V} \leq V_{DD1}, V_{DD2}, V_{DDP} \leq 5.5\text{ V}$ and $-40^\circ\text{C} \leq T_A \leq +105^\circ\text{C}$, unless otherwise noted. Switching specifications are tested with $C_L = 15\text{ pF}$ and CMOS signal levels, unless otherwise noted.

Table 3. DC-to-DC Converter Static Specifications

Parameter	Symbol	Min	Typ	Max	Unit	Test Conditions/Comments
DC-TO-DC CONVERTER SUPPLY						
Setpoint	V_{ISO}	4.675	5.0	5.325	V	$I_{ISO} = 15\text{ mA}$, $R_1 = 10\text{ k}\Omega$, $R_2 = 30.9\text{ k}\Omega$
Thermal Coefficient	$V_{ISO(TC)}$		-44		$\mu\text{V}/^\circ\text{C}$	
Line Regulation	$V_{ISO(LINE)}$		20		mV/V	$I_{ISO} = 15\text{ mA}$, $V_{DDP} = 4.5\text{ V}$ to 5.5 V
Load Regulation	$V_{ISO(LOAD)}$		1.3	3	%	$I_{ISO} = 3\text{ mA}$ to 27 mA
Output Ripple	$V_{ISO(RIP)}$		75		mV p-p	20 MHz bandwidth, $C_{BO} = 0.1\text{ }\mu\text{F} 10\text{ }\mu\text{F}$, $I_{ISO} = 27\text{ mA}$
Output Noise	$V_{ISO(NOISE)}$		200		mV p-p	$C_{BO} = 0.1\text{ }\mu\text{F} 10\text{ }\mu\text{F}$, $I_{ISO} = 27\text{ mA}$
Switching Frequency	f_{OSC}		125		MHz	
Pulse-Width Modulation Frequency	f_{PWM}		600		kHz	
Output Supply	$I_{ISO(MAX)}$	30			mA	$V_{ISO} > 4.675\text{ V}$
Efficiency at $I_{ISO(MAX)}$		20	29	36	%	$I_{ISO} = 27\text{ mA}$
I_{DDP} , No V_{ISO} Load	$I_{DDP(Q)}$		6.8	12	mA	
I_{DDP} , Full V_{ISO} Load	$I_{DDP(MAX)}$	80	104	142	mA	
Thermal Shutdown						
Shutdown Temperature			154		$^\circ\text{C}$	
Thermal Hysteresis			10		$^\circ\text{C}$	

Table 4. Data Channel Supply Current

Parameter	Symbol	1 Mbps—A, B, C Grades			25 Mbps—B, C Grades			100 Mbps—C Grade			Unit	Test Conditions/Comments		
		Min	Typ	Max	Min	Typ	Max	Min	Typ	Max				
SUPPLY CURRENT														
ADuM6210	I_{DD1}		1.1	1.6			6.2	7.0			20	25	mA	$C_L = 0\text{ pF}$
	I_{DD2}		2.7	4.5			4.8	7.0			9.5	15	mA	$C_L = 0\text{ pF}$
ADuM6211	I_{DD1}		2.1	2.7			4.9	6.5			15	19	mA	$C_L = 0\text{ pF}$
	I_{DD2}		2.3	2.9			4.7	6.5			15.6	19	mA	$C_L = 0\text{ pF}$
ADuM6212	I_{DD1}		2.7	4.5			4.8	7.0			9.5	15	mA	$C_L = 0\text{ pF}$
	I_{DD2}		1.1	1.6			6.2	7.0			20	25	mA	$C_L = 0\text{ pF}$

Table 5. Switching Specifications

Parameter	Symbol	A Grade			B Grade			C Grade			Unit	Test Conditions/Comments
		Min	Typ	Max	Min	Typ	Max	Min	Typ	Max		
SWITCHING SPECIFICATIONS												
Data Rate				1			25			100	Mbps	Within PWD limit
Propagation Delay	t_{PHL}, t_{PLH}			50			35	20	23	29	ns	50% input to 50% output
Pulse Width Distortion	PWD			10			3			2	ns	$ t_{PLH} - t_{PHL} $
Pulse Width	PW	1000			40			10			ns	Within PWD limit
Propagation Delay Skew	t_{PSK}			38			12			9	ns	Between any two units
Channel Matching												
Codirectional	t_{PSKCD}			5			3			2	ns	
Opposing Direction	t_{PSKOD}			10			6			5	ns	
Jitter				2			2			1	ns	

Table 6. Input and Output Characteristics

Parameter	Symbol	Min	Typ	Max	Unit	Test Conditions/Comments
DC SPECIFICATIONS						
Logic High Input Threshold	V_{IH}	$0.7 V_{ISO}$, $0.7 V_{DD1}$			V	
Logic Low Input Threshold	V_{IL}			$0.3 V_{ISO}$, $0.3 V_{DD1}$	V	
Logic High Output Voltages	V_{OH}	$V_{DD1} - 0.1$, $V_{DD2} - 0.1$	V_{DD1}, V_{DD2}		V	$I_{Ox} = -20 \mu A, V_{Ix} = V_{IxH}$
		$V_{DD1} - 0.4$, $V_{DD2} - 0.4$	$V_{DD1} - 0.2$, $V_{DD2} - 0.2$		V	$I_{Ox} = -3.2 \text{ mA}, V_{Ix} = V_{IxH}$
Logic Low Output Voltages	V_{OL}		0.0	0.1	V	$I_{Ox} = 20 \mu A, V_{Ix} = V_{IxL}$
			0.2	0.4	V	$I_{Ox} = 3.2 \text{ mA}, V_{Ix} = V_{IxL}$
Undervoltage Lockout						$V_{DD1}, V_{DD2}, V_{DDP}$ supply
Positive Going Threshold	V_{UV+}		2.75		V	
Negative Going Threshold	V_{UV-}		2.65		V	
Hysteresis	V_{UVH}		0.2		V	
Supply Current per Channel						
Quiescent Input Supply Current	$I_{DDI(Q)}$		0.54	0.8	mA	
Quiescent Output Supply Current	$I_{DDO(Q)}$		1.6	2.0	mA	
Dynamic Input Supply Current	$I_{DDI(D)}$		0.09		mA/Mbps	
Dynamic Output Supply Current	$I_{DDO(D)}$		0.04		mA/Mbps	
Input Currents per Channel	I_i	-10	+0.01	+10	μA	$0 V \leq V_{Ix} \leq V_{DDx}$
AC SPECIFICATIONS						
Output Rise/Fall Time	t_R/t_F		2.5		ns	10% to 90%
Common-Mode Transient Immunity ¹	$ CM $	25	35		kV/ μs	$V_{Ix} = V_{DD1}$ or V_{ISO} , $V_{CM} = 1000 \text{ V}$, transient magnitude = 800 V
Refresh Rate	t_r		1.6		μs	

¹ $|CM|$ is the maximum common-mode voltage slew rate that can be sustained while maintaining $V_{Ox} > 0.8 \times V_{DD1}$ or $0.8 \times V_{ISO}$ for a high input or $V_{Ox} < 0.8 \times V_{DD1}$ or $0.8 \times V_{ISO}$ for a low input. The common-mode voltage slew rates apply to both rising and falling common-mode voltage edges.

ELECTRICAL CHARACTERISTICS—3.3 V PRIMARY INPUT SUPPLY/3.3 V SECONDARY ISOLATED SUPPLY

All typical specifications are at $T_A = 25^\circ\text{C}$, $V_{DD1} = V_{DD2} = V_{DDP} = 3.3\text{ V}$, V_{SEL} resistor network: $R_1 = 10\text{ k}\Omega$, $R_2 = 16.9\text{ k}\Omega$ between V_{ISO} and GND_{ISO} . Minimum/maximum specifications apply over the entire recommended operation range, which is $3.135\text{ V} \leq V_{DD1}, V_{DD2}, V_{DDP} \leq 3.6\text{ V}$, and $-40^\circ\text{C} \leq T_A \leq +105^\circ\text{C}$, unless otherwise noted. Switching specifications are tested with $C_L = 15\text{ pF}$ and CMOS signal levels, unless otherwise noted.

The digital isolator channels and the power section work independently, and under the operating voltages in this section, there may not be sufficient current from the V_{ISO} to run both data channels at the maximum data rate. Verify that the application is within the power capability of V_{ISO} if that supply is providing power to V_{DD2} .

Table 7. DC-to-DC Converter Static Specifications

Parameter	Symbol	Min	Typ	Max	Unit	Test Conditions/Comments
DC-TO-DC CONVERTER SUPPLY						
Setpoint	V_{ISO}	3.135	3.3	3.51	V	$I_{ISO} = 10\text{ mA}$, $R_1 = 10\text{ k}\Omega$, $R_2 = 16.9\text{ k}\Omega$
Thermal Coefficient	$V_{ISO(TC)}$		-26		$\mu\text{V}/^\circ\text{C}$	$I_{ISO} = 20\text{ mA}$
Line Regulation	$V_{ISO(LINE)}$		20		mV/V	$I_{ISO} = 10\text{ mA}$, $V_{DDP} = 3.135\text{ V}$ to 3.6 V
Load Regulation	$V_{ISO(LOAD)}$		1.3	3	%	$I_{ISO} = 2\text{ mA}$ to 18 mA
Output Ripple	$V_{ISO(RIP)}$		50		mV p-p	20 MHz bandwidth, $C_{BO} = 0.1\text{ }\mu\text{F}$ $10\text{ }\mu\text{F}$, $I_{ISO} = 18\text{ mA}$
Output Noise	$V_{ISO(NOISE)}$		130		mV p-p	$C_{BO} = 0.1\text{ }\mu\text{F}$ $10\text{ }\mu\text{F}$, $I_{ISO} = 18\text{ mA}$
Switching Frequency	f_{OSC}		125		MHz	
Pulse-Width Modulation Frequency	f_{PWM}		600		kHz	
Output Supply	$I_{ISO(MAX)}$	20			mA	$V_{ISO} > 3.135\text{ V}$
Efficiency at $I_{ISO(MAX)}$		18	27	33	%	$I_{ISO} = 18\text{ mA}$
I_{DDP} , No V_{ISO} Load	$I_{DDP(Q)}$		3.3	10.5	mA	
I_{DDP} , Full V_{ISO} Load	$I_{DDP(MAX)}$	60	77	105	mA	
Thermal Shutdown						
Shutdown Temperature			154		$^\circ\text{C}$	
Thermal Hysteresis			10		$^\circ\text{C}$	

Table 8. Data Channel Supply Current

Parameter	Symbol	1 Mbps—A, B, C Grades			25 Mbps—B, C Grades			100 Mbps—C Grade			Unit	Test Conditions/Comments
		Min	Typ	Max	Min	Typ	Max	Min	Typ	Max		
SUPPLY CURRENT												
ADuM6210	I_{DD1}		0.75	1.4		5.1	9.0		17	23	mA	$C_L = 0\text{ pF}$
	I_{DD2}		2.0	3.5		2.7	4.6		4.8	9	mA	$C_L = 0\text{ pF}$
ADuM6211	I_{DD1}		1.6	2.1		3.8	5.0		11	15	mA	$C_L = 0\text{ pF}$
	I_{DD2}		1.7	2.3		3.9	6.2		11	15	mA	$C_L = 0\text{ pF}$
ADuM6212	I_{DD1}		2.0	3.5		2.7	4.6		4.8	9	mA	$C_L = 0\text{ pF}$
	I_{DD2}		0.75	1.4		5.1	9.0		17	23	mA	$C_L = 0\text{ pF}$

Table 9. Switching Specifications

Parameter	Symbol	A Grade			B Grade			C Grade			Unit	Test Conditions/Comments
		Min	Typ	Max	Min	Typ	Max	Min	Typ	Max		
SWITCHING SPECIFICATIONS												
Data Rate				1			25			100	Mbps	Within PWD limit
Propagation Delay	t_{PHL}, t_{PLH}			50			35	22	27	35	ns	50% input to 50% output
Pulse Width Distortion	PWD			10			3			2.5	ns	$ t_{PLH} - t_{PHL} $
Pulse Width	PW	1000			40			10			ns	Within PWD limit
Propagation Delay Skew	t_{PSK}			38			16			12	ns	Between any two units
Channel Matching												
Codirectional	t_{PSKCD}			5			3			2.5	ns	
Opposing Direction	t_{PSKOD}			10			6			5	ns	
Jitter				2			2			1	ns	

Table 10. Input and Output Characteristics

Parameter	Symbol	Min	Typ	Max	Unit	Test Conditions/Comments
DC SPECIFICATIONS						
Logic High Input Threshold	V_{IH}	$0.7 V_{ISO}$, $0.7 V_{DD1}$			V	
Logic Low Input Threshold	V_{IL}			$0.3 V_{ISO}$, $0.3 V_{DD1}$	V	
Logic High Output Voltages	V_{OH}	$V_{DD1} - 0.1$, $V_{DD2} - 0.1$	V_{DD1}, V_{DD2}		V	$I_{Ox} = -20 \mu A, V_{Ix} = V_{IxH}$
			$V_{DD1} - 0.4$, $V_{DD2} - 0.4$	$V_{DD1} - 0.2$, $V_{DD2} - 0.2$		V
Logic Low Output Voltages	V_{OL}		0.0	0.1	V	$I_{Ox} = 20 \mu A, V_{Ix} = V_{IxL}$
				0.2	0.4	V
Undervoltage Lockout						$V_{DD1}, V_{DD2}, V_{DDP}$ supply
Positive Going Threshold	V_{UV+}		2.75		V	
Negative Going Threshold	V_{UV-}		2.65		V	
Hysteresis	V_{UVH}		0.2		V	
Supply Current per Channel						
Quiescent Input Supply Current	$I_{DDI(Q)}$		0.4	0.6	mA	
Quiescent Output Supply Current	$I_{DDO(Q)}$		1.2	1.7	mA	
Dynamic Input Supply Current	$I_{DDI(D)}$		0.08		mA/Mbps	
Dynamic Output Supply Current	$I_{DDO(D)}$		0.015		mA/Mbps	
Input Currents per Channel	I_i	-10	+0.01	+10	μA	$0V \leq V_{Ix} \leq V_{DDx}$
AC SPECIFICATIONS						
Output Rise/Fall Time	t_R/t_F		3		ns	10% to 90%
Common-Mode Transient Immunity ¹	$ CM $	25	35		kV/ μs	$V_{Ix} = V_{DD1}$ or V_{ISO} , $V_{CM} = 1000 V$, transient magnitude = 800 V
Refresh Rate	t_r		1.6		μs	

¹ $|CM|$ is the maximum common-mode voltage slew rate that can be sustained while maintaining $V_{Ox} > 0.8 \times V_{DD1}$ or $0.8 \times V_{ISO}$ for a high input or $V_{Ox} < 0.8 \times V_{DD1}$ or $0.8 \times V_{ISO}$ for a low input. The common-mode voltage slew rates apply to both rising and falling common-mode voltage edges.

ELECTRICAL CHARACTERISTICS—5 V PRIMARY INPUT SUPPLY/3.3 V SECONDARY ISOLATED SUPPLY

All typical specifications are at $T_A = 25^\circ\text{C}$, $V_{DD1} = V_{DDP} = 5\text{ V}$, $V_{DD2} = 3.3\text{ V}$, V_{SEL} resistor network: $R1 = 10\text{ k}\Omega$, $R2 = 16.9\text{ k}\Omega$ between V_{ISO} and GND_{ISO} . Minimum/maximum specifications apply over the entire recommended operation range, which is $4.5\text{ V} \leq V_{DD1}$, $V_{DDP} \leq 5.5\text{ V}$, $3.135\text{ V} \leq V_{DD2} \leq 3.6\text{ V}$, and $-40^\circ\text{C} \leq T_A \leq +105^\circ\text{C}$, unless otherwise noted. Switching specifications are tested with $C_L = 15\text{ pF}$ and CMOS signal levels, unless otherwise noted.

Table 11. DC-to-DC Converter Static Specifications

Parameter	Symbol	Min	Typ	Max	Unit	Test Conditions/Comments
DC-TO-DC CONVERTER SUPPLY						
Setpoint	V_{ISO}	3.135	3.3	3.51	V	$I_{ISO} = 15\text{ mA}$, $R1 = 10\text{ k}\Omega$, $R2 = 16.9\text{ k}\Omega$
Thermal Coefficient	$V_{ISO(TC)}$		-26		$\mu\text{V}/^\circ\text{C}$	
Line Regulation	$V_{ISO(LINE)}$		20		mV/V	$I_{ISO} = 15\text{ mA}$, $V_{DDP} = 4.5\text{ V to } 5.5\text{ V}$
Load Regulation	$V_{ISO(LOAD)}$		1.3	3	%	$I_{ISO} = 3\text{ mA to } 27\text{ mA}$
Output Ripple	$V_{ISO(RIP)}$		50		mV p-p	20 MHz bandwidth, $C_{BO} = 0.1\text{ }\mu\text{F} 10\text{ }\mu\text{F}$, $I_{ISO} = 27\text{ mA}$
Output Noise	$V_{ISO(NOISE)}$		130		mV p-p	$C_{BO} = 0.1\text{ }\mu\text{F} 10\text{ }\mu\text{F}$, $I_{ISO} = 27\text{ mA}$
Switching Frequency	f_{OSC}		125		MHz	
Pulse-Width Modulation Frequency	f_{PWM}		600		kHz	
Output Supply	$I_{ISO(MAX)}$	30			mA	$V_{ISO} > 3.135\text{ V}$
Efficiency at $I_{ISO(MAX)}$		20	24	35	%	$I_{ISO} = 27\text{ mA}$
I_{DDP} , No V_{ISO} Load	$I_{DDP(Q)}$		3.2	8	mA	
I_{DDP} , Full V_{ISO} Load	$I_{DDP(MAX)}$	70	85	105	mA	
Thermal Shutdown						
Shutdown Temperature			154		$^\circ\text{C}$	
Thermal Hysteresis			10		$^\circ\text{C}$	

Table 12. Data Channel Supply Current

Parameter	Symbol	1 Mbps—A, B, C Grades			25 Mbps—B, C Grades			100 Mbps—C Grade			Unit	Test Conditions/Comments	
		Min	Typ	Max	Min	Typ	Max	Min	Typ	Max			
SUPPLY CURRENT													
ADuM6210	I_{DD1}		1.1	1.6		6.2	7.0		20	25		mA	$C_L = 0\text{ pF}$
	I_{DD2}		2.0	3.5		2.7	4.6		4.8	9.0		mA	$C_L = 0\text{ pF}$
ADuM6211	I_{DD1}		2.1	2.7		4.9	6.5		15	19		mA	$C_L = 0\text{ pF}$
	I_{DD2}		1.7	2.3		3.9	6.2		11	15		mA	$C_L = 0\text{ pF}$
ADuM6212	I_{DD1}		2.0	3.5		2.7	4.6		4.8	9.0		mA	$C_L = 0\text{ pF}$
	I_{DD2}		1.1	1.6		6.2	7.0		20	25		mA	$C_L = 0\text{ pF}$

Table 13. Switching Specifications

Parameter	Symbol	A Grade			B Grade			C Grade			Unit	Test Conditions/Comments	
		Min	Typ	Max	Min	Typ	Max	Min	Typ	Max			
SWITCHING SPECIFICATIONS													
Data Rate				1			25			100		Mbps	Within PWD limit
Propagation Delay	t_{PHL} , t_{PLH}			50			35	20	25	31		ns	50% input to 50% output
Pulse Width Distortion	PWD			10			3			2.5		ns	$ t_{PLH} - t_{PHL} $
Pulse Width	PW	1000			40			10				ns	Within PWD limit
Propagation Delay Skew	t_{PSK}			38			16			12		ns	Between any two units
Channel Matching													
Codirectional	t_{PSKCD}			5			3			2		ns	
Opposing Direction	t_{PSKOD}			10			6			5		ns	
Jitter				2			2			1		ns	

Table 14. Input and Output Characteristics

Parameter	Symbol	Min	Typ	Max	Unit	Test Conditions/Comments
DC SPECIFICATIONS						
Logic High Input Threshold	V_{IH}	$0.7 V_{ISO}$, $0.7 V_{DD1}$			V	
Logic Low Input Threshold	V_{IL}			$0.3 V_{ISO}$, $0.3 V_{DD1}$	V	
Logic High Output Voltages	V_{OH}	$V_{DD1} - 0.1$, $V_{DD2} - 0.1$	V_{DD1}, V_{DD2}		V	$I_{Ox} = -20 \mu A, V_{Ix} = V_{IxH}$
		$V_{DD1} - 0.4$, $V_{DD2} - 0.4$	$V_{DD1} - 0.2$, $V_{DD2} - 0.2$		V	$I_{Ox} = -3.2 \text{ mA}, V_{Ix} = V_{IxH}$
Logic Low Output Voltages	V_{OL}		0.0	0.1	V	$I_{Ox} = 20 \mu A, V_{Ix} = V_{IxL}$
			0.2	0.4	V	$I_{Ox} = 3.2 \text{ mA}, V_{Ix} = V_{IxL}$
Undervoltage Lockout						$V_{DD1}, V_{DD2}, V_{DDP}$ supply
Positive Going Threshold	V_{UV+}		2.75		V	
Negative Going Threshold	V_{UV-}		2.65		V	
Hysteresis	V_{UVH}		0.2		V	
Supply Current per Channel						
Quiescent Input Supply Current	$I_{DDI(Q)}$		0.54	0.75	mA	
Quiescent Output Supply Current	$I_{DDO(Q)}$		1.2	2.0	mA	
Dynamic Input Supply Current	$I_{DDI(D)}$		0.09		mA/Mbps	
Dynamic Output Supply Current	$I_{DDO(D)}$		0.02		mA/Mbps	
Input Currents per Channel	I_I	-10	+0.01	+10	μA	$0V \leq V_{Ix} \leq V_{DDx}$
AC SPECIFICATIONS						
Output Rise/Fall Time	t_R/t_F		2.5		ns	10% to 90%
Common-Mode Transient Immunity ¹	$ CM $	25	35		kV/ μs	$V_{Ix} = V_{DD1}$ or V_{ISO} , $V_{CM} = 1000 \text{ V}$, transient magnitude = 800 V
Refresh Rate	t_r		1.6		μs	

¹ $|CM|$ is the maximum common-mode voltage slew rate that can be sustained while maintaining $V_{Ox} > 0.8 \times V_{DD1}$ or $0.8 \times V_{ISO}$ for a high input or $V_{Ox} < 0.8 \times V_{DD1}$ or $0.8 \times V_{ISO}$ for a low input. The common-mode voltage slew rates apply to both rising and falling common-mode voltage edges.

PACKAGE CHARACTERISTICS**Table 15. Thermal and Isolation Characteristics**

Parameter	Symbol	Min	Typ	Max	Unit	Test Conditions/Comments
Resistance (Input to Output) ¹	R _{I-O}		10 ¹²		Ω	
Capacitance (Input to Output) ¹	C _{I-O}		2.2		pF	f = 1 MHz
Input Capacitance ²	C _I		4.0		pF	
IC Junction-to-Ambient Thermal Resistance	θ _{JA}		50		°C/W	Thermocouple located at center of package underside, test conducted on 4-layer board with thin traces ³

¹ The device is considered a 2-terminal device: Pin 1 through Pin 10 are shorted together; and Pin 11 through Pin 20 are shorted together.

² Input capacitance is from any input data pin to ground.

³ See the Thermal Analysis section for thermal model definitions.

REGULATORY APPROVALS**Table 16.**

UL ¹	CSA	VDE ²
Recognized under 1577 Component Recognition Program ¹ Single Protection, 3750 V _{RMS} Isolation Voltage File E214100	Approved under CSA Component Acceptance Notice 5A Reinforced insulation per CSA 60950-1-03 and IEC 60950-1, 265 V rms (375 V peak) maximum working voltage File 205078	Certified according to DIN V VDE V 0884-10 (VDE V 0884-10):2006-12 ² Reinforced insulation, 849 V peak File 2471900-4880-0001

¹ In accordance with UL 1577, each ADuM6210/ADuM6211/ADuM6212 is proof tested by applying an insulation test voltage ≥ 4500 V rms for 1 second (current leakage detection limit = 10 μA).

² In accordance with DIN V VDE V 0884-10, each ADuM6210/ADuM6211/ADuM6212 is proof tested by applying an insulation test voltage ≥ 1590 V peak for 1 second (partial discharge detection limit = 5 pC). The * marking branded on the component designates DIN V VDE V 0884-10 approval.

INSULATION AND SAFETY-RELATED SPECIFICATIONS**Table 17. Critical Safety-Related Dimensions and Material Properties**

Parameter	Symbol	Value	Unit	Test Conditions/Comments
Rated Dielectric Insulation Voltage		3750	V rms	1-minute duration
Minimum External Air Gap (Clearance)	L(I01)	5.3	mm	Measured from input terminals to output terminals, shortest distance through air
Minimum External Tracking (Creepage)	L(I02)	5.3	mm	Measured from input terminals to output terminals, shortest distance path along body
Minimum Internal Gap (Internal Clearance)		0.017 min	mm	Distance through insulation
Tracking Resistance (Comparative Tracking Index)	CTI	>400	V	DIN IEC 112/VDE 0303, Part 1
Isolation Group		II		Material group (DIN VDE 0110, 1/89, Table 1)

DIN V VDE V 0884-10 (VDE V 0884-10) INSULATION CHARACTERISTICS

These isolators are suitable for reinforced electrical isolation only within the safety limit data. Maintenance of the safety data is ensured by the protective circuits. The asterisk (*) marking on packages denotes DIN V VDE V 0884-10 approval.

Table 18. VDE Characteristics

Description	Test Conditions/Comments	Symbol	Characteristic	Unit
Installation Classification per DIN VDE 0110 For Rated Mains Voltage ≤ 150 V rms For Rated Mains Voltage ≤ 300 V rms For Rated Mains Voltage ≤ 400 V rms			I to IV I to IV I to III	
Climatic Classification			40/105/21	
Pollution Degree per DIN VDE 0110, Table 1			2	
Maximum Working Insulation Voltage		V_{IORM}	849	V peak
Input-to-Output Test Voltage, Method b1	$V_{IORM} \times 1.875 = V_{pd(m)}$, 100% production test, $t_{ini} = t_m = 1$ sec, partial discharge < 5 pC	$V_{pd(m)}$	1592	V peak
Input-to-Output Test Voltage, Method a After Environmental Tests Subgroup 1	$V_{IORM} \times 1.5 = V_{pd(m)}$, $t_{ini} = 60$ sec, $t_m = 10$ sec, partial discharge < 5 pC	$V_{pd(m)}$	1273	V peak
After Input and/or Safety Test Subgroup 2 and Subgroup 3	$V_{IORM} \times 1.2 = V_{pd(m)}$, $t_{ini} = 60$ sec, $t_m = 10$ sec, partial discharge < 5 pC	$V_{pd(m)}$	1018	V peak
Highest Allowable Overvoltage		V_{IOTM}	5300	V peak
Withstand Isolation Voltage	1 minute withstand rating	V_{ISO}	3750	V rms
Surge Isolation Voltage	$V_{IOSM(TEST)} = 10$ kV, 1.2 μ s rise time, 50 μ s, 50% fall time	V_{IOSM}	6000	V peak
Safety Limiting Values	Maximum value allowed in the event of a failure			
Case Temperature	See Figure 2	T_S	150	°C
Safety Total Dissipated Power		I_{S1}	2.5	W
Insulation Resistance at T_S	$V_{io} = 500$ V	R_S	>10 ⁹	Ω



Figure 2. Thermal Derating Curve, Dependence of Safety Limiting Values on Case Temperature, per DIN V VDE V 0884-10

RECOMMENDED OPERATING CONDITIONS

Table 19.

Parameter	Symbol	Min	Max	Unit
Operating Temperature ¹	T_A	-40	+105	°C
Supply Voltages ²				
V_{DDP} at $V_{ISO} = 3.135$ V to 3.6 V	V_{DDP}	3.135	5.5	V
V_{DDP} at $V_{ISO} = 4.5$ V to 5.5 V		4.5	5.5	V
V_{DD1}, V_{DD2}	V_{DD1}, V_{DD2}	3.135	5.5	V

¹ Operation at 105°C requires reduction of the maximum load current as specified in Table 20.

² Each voltage is relative to its respective ground.

ABSOLUTE MAXIMUM RATINGS

Ambient temperature = 25°C, unless otherwise noted.

Table 20.

Parameter	Rating
Storage Temperature Range (T _{ST})	-55°C to +150°C
Ambient Operating Temperature Range (T _A)	-40°C to +105°C
Supply Voltages (V _{DDP} , V _{DD1} , V _{DD2} , V _{ISO}) ¹	-0.5 V to +7.0 V
V _{ISO} Supply Current ² T _A = -40°C to +105°C	30 mA
Input Voltage (V _{IA} , V _{IB} , PDIS, V _{SEL}) ^{1,3}	-0.5 V to V _{DD1} + 0.5 V
Output Voltage (V _{OA} , V _{OB}) ^{1,3}	-0.5 V to V _{DDO} + 0.5 V
Average Output Current Per Data Output Pin ⁴	-10 mA to +10 mA
Common-Mode Transients ⁵	-100 kV/μs to +100 kV/μs

¹ All voltages are relative to their respective ground.

² The V_{ISO} provides current for dc and dynamic loads on the V_{ISO} I/O channels. This current must be included when determining the total V_{ISO} supply current. For ambient temperatures between 85°C and 105°C, maximum allowed current is reduced.

³ V_{DD1} and V_{DDO} refer to the supply voltages on the input and output sides of a given channel, respectively. See the PCB Layout section.

⁴ See Figure 2 for the maximum rated current values for various temperatures.

⁵ Refers to common-mode transients across the insulation barrier. Common-mode transients exceeding the absolute maximum ratings may cause latch-up or permanent damage.

Stresses at or above those listed under Absolute Maximum Ratings may cause permanent damage to the product. This is a stress rating only; functional operation of the product at these or any other conditions above those indicated in the operational section of this specification is not implied. Operation beyond the maximum operating conditions for extended periods may affect product reliability.

Table 21. Maximum Continuous Working Voltage Supporting 50-Year Minimum Lifetime¹

Parameter	Max	Unit	Applicable Certification
AC Voltage			
Bipolar Waveform	560	V peak	All certifications, 50-year operation
Unipolar Waveform	560	V peak	
DC Voltage			
DC Peak Voltage	560	V peak	

¹ Refers to the continuous voltage magnitude imposed across the isolation barrier. See the Insulation Lifetime section for more information.

ESD CAUTION



ESD (electrostatic discharge) sensitive device. Charged devices and circuit boards can discharge without detection. Although this product features patented or proprietary protection circuitry, damage may occur on devices subjected to high energy ESD. Therefore, proper ESD precautions should be taken to avoid performance degradation or loss of functionality.

PIN CONFIGURATIONS AND FUNCTION DESCRIPTIONS



NOTES
 1. PINS LABELED NC CAN BE ALLOWED TO FLOAT, BUT IT IS BETTER TO CONNECT THESE PINS TO GROUND. AVOID ROUTING HIGH SPEED SIGNALS THROUGH THESE PINS BECAUSE NOISE COUPLING MAY RESULT.

11042-003

Figure 3. ADuM6210 Pin Configuration

Table 22. ADuM6210 Pin Function Descriptions

Pin No.	Mnemonic	Description
1	V _{DD1}	Power Supply for the Side 1 Logic Circuits of the Device. It is independent of V _{DDP} and can operate between 3.135 V and 5.5 V.
2, 5, 6, 10	GND _P	Ground Reference for Isolator Side 1. All of these pins are internally connected, and it is recommended that all GND _P pins be connected to a common ground.
3	V _{IA}	Logic Input A.
4	V _{IB}	Logic Input B.
7, 14	NC	No Connect. Pins labeled NC can be allowed to float, but it is better to connect these pins to ground. Avoid routing high speed signals through these pins because noise coupling may result.
8	PDIS	Power Disable. When this pin is tied to a logic low, the power converter is active; when tied to a logic high, the power supply enters a low power standby mode.
9	V _{DDP}	Primary <i>iso</i> Power Supply Voltage, 3.135 V to 5.5 V.
11, 15, 16, 19	GND _{ISO}	Ground Reference for Isolator Side 2. All of these pins are internally connected, and it is recommended that all GND _{ISO} pins be connected to a common ground.
12	V _{ISO}	Secondary Supply Voltage Output for External Loads, 3.3 V (V _{SEL} Low) or 5.0 V (V _{SEL} High).
13	V _{SEL}	Output Voltage Select. Provide a thermally matched resistor network between V _{ISO} and GND _{ISO} to divide the required output voltage to match the 1.25 V reference voltage. V _{ISO} voltage can be programmed up to 20% higher or 75% lower than V _{DDP} but must be within the allowed output voltage range.
17	V _{OB}	Logic Output B.
18	V _{OA}	Logic Output A.
20	V _{DD2}	Power Supply for the Side 2 Logic Circuits of the Device. It is independent of V _{ISO} and can operate between 3.135 V and 5.5 V.

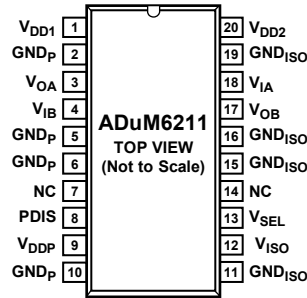

NOTES
 1. PINS LABELED NC CAN BE ALLOWED TO FLOAT, BUT IT IS BETTER TO CONNECT THESE PINS TO GROUND. AVOID ROUTING HIGH SPEED SIGNALS THROUGH THESE PINS BECAUSE NOISE COUPLING MAY RESULT.

Figure 4. ADuM6211 Pin Configuration

Table 23. ADuM6211 Pin Function Descriptions

Pin No.	Mnemonic	Description
1	V _{DD1}	Power Supply for the Side 1 Logic Circuits of the Device. It is independent of V _{DDP} and can operate between 3.135 V and 5.5 V.
2, 5, 6, 10	GND _P	Ground Reference for Isolator Side 1. All of these pins are internally connected, and it is recommended that all GND _P pins be connected to a common ground.
3	V _{OA}	Logic Output A.
4	V _{IB}	Logic Input B.
7, 14	NC	No Connect. Pins labeled NC can be allowed to float, but it is better to connect these pins to ground. Avoid routing high speed signals through these pins because noise coupling may result.
8	PDIS	Power Disable. When this pin is tied to a logic low, the power converter is active; when tied to a logic high, the power supply enters a low power standby mode.
9	V _{DDP}	Primary <i>iso</i> Power Supply Voltage, 3.135 V to 5.5 V.
11, 15, 16, 19	GND _{ISO}	Ground Reference for Isolator Side 2. All of these pins are internally connected, and it is recommended that all GND _{ISO} pins be connected to a common ground.
12	V _{ISO}	Secondary Supply Voltage Output for External Loads, 3.3 V (V _{SEL} Low) or 5.0 V (V _{SEL} High).
13	V _{SEL}	Output Voltage Select. Provide a thermally matched resistor network between V _{ISO} and GND _{ISO} to divide the required output voltage to match the 1.25 V reference voltage. V _{ISO} voltage can be programmed up to 20% higher or 75% lower than V _{DDP} but must be within the allowed output voltage range.
17	V _{OB}	Logic Output B.
18	V _{IA}	Logic Input A.
20	V _{DD2}	Power Supply for the Side 2 Logic Circuits of the Device. It is independent of V _{ISO} and can operate between 3.135 V and 5.5 V.



NOTES
 1. PINS LABELED NC CAN BE ALLOWED TO FLOAT, BUT IT IS BETTER TO CONNECT THESE PINS TO GROUND. AVOID ROUTING HIGH SPEED SIGNALS THROUGH THESE PINS BECAUSE NOISE COUPLING MAY RESULT.

11042-007

Figure 5. ADuM6212 Pin Configuration

Table 24. ADuM6212 Pin Function Descriptions

Pin No.	Mnemonic	Description
1	V _{DD1}	Power Supply for the Side 1 Logic Circuits of the Device. It is independent of V _{DDP} and can operate between 3.135 V and 5.5 V.
2, 5, 6, 10	GND _P	Ground Reference for Isolator Side 1. All of these pins are internally connected, and it is recommended that all GND _P pins be connected to a common ground.
3	V _{OA}	Logic Output A.
4	V _{OB}	Logic Output B.
7, 14	NC	No Connect. Pins labeled NC can be allowed to float, but it is better to connect these pins to ground. Avoid routing high speed signals through these pins because noise coupling may result.
8	PDIS	Power Disable. When this pin is tied to a logic low, the power converter is active; when tied to a logic high, the power supply enters a low power standby mode.
9	V _{DDP}	Primary <i>iso</i> Power Supply Voltage, 3.135 V to 5.5 V.
11, 15, 16, 19	GND _{ISO}	Ground Reference for Isolator Side 2. All of these pins are internally connected, and it is recommended that all GND _{ISO} pins be connected to a common ground.
12	V _{ISO}	Secondary Supply Voltage Output for External Loads, 3.3 V (V _{SEL} Low) or 5.0 V (V _{SEL} High).
13	V _{SEL}	Output Voltage Select. Provide a thermally matched resistor network between V _{ISO} and GND _{ISO} to divide the required output voltage to match the 1.25 V reference voltage. V _{ISO} voltage can be programmed up to 20% higher or 75% lower than V _{DDP} but must be within the allowed output voltage range.
17	V _{IB}	Logic Input B.
18	V _{IA}	Logic Input A.
20	V _{DD2}	Power Supply for the Side 2 Logic Circuits of the Device. It is independent of V _{ISO} and can operate between 3.135 V and 5.5 V.

TRUTH TABLES

Table 25. Power Section Truth Table (Positive Logic)

V _{DDP} (V)	V _{SEL} Input	PDIS Input	V _{ISO} Output (V)	Notes
5	R1 = 10 kΩ, R2 = 30.9 kΩ	Low	5	Configuration not recommended
5	R1 = 10 kΩ, R2 = 30.9 kΩ	High	0	
3.3	R1 = 10 kΩ, R2 = 16.9 kΩ	Low	3.3	
3.3	R1 = 10 kΩ, R2 = 16.9 kΩ	High	0	
5	R1 = 10 kΩ, R2 = 30.9 kΩ	Low	3.3	
5	R1 = 10 kΩ, R2 = 30.9 kΩ	High	0	
3.3	R1 = 10 kΩ, R2 = 16.9 kΩ	Low	5	
3.3	R1 = 10 kΩ, R2 = 16.9 kΩ	High	0	

Table 26 Data Section Truth Table (Positive Logic)

V _{DDI} State ¹	V _{ix} Input ¹	V _{DDO} State ¹	V _{Ox} Output ¹	Notes
Powered	High	Powered	High	Normal operation, data is high
Powered	Low	Powered	Low	Normal operation, data is low
X ²	X ²	Unpowered	Z ³	Output is off
Unpowered	Low	Powered	Low	Output default low
Unpowered	High	Powered	Indeterminate	If a high level is applied to an input when no supply is present, it can parasitically power the input side, causing unpredictable operation

¹ The references to I and O in this table refer to the input side and output side of a given data path and the associated power supply.

² X = don't care.

³ Z = high impedance state.

TYPICAL PERFORMANCE CHARACTERISTICS



Figure 6. Typical Power Supply Efficiency at 5 V/5 V, 3.3 V/3.3 V, and 5 V/3.3 V



Figure 9. Typical Short-Circuit Input Current and Power Dissipation vs. V_{DD1} Supply Voltage

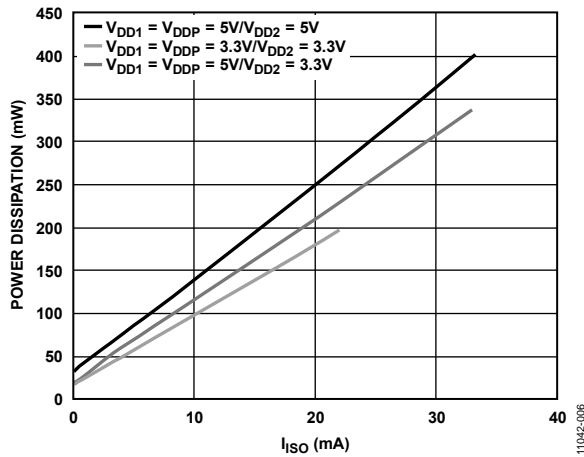

Figure 7. Typical Total Power Dissipation vs. I_{iso}

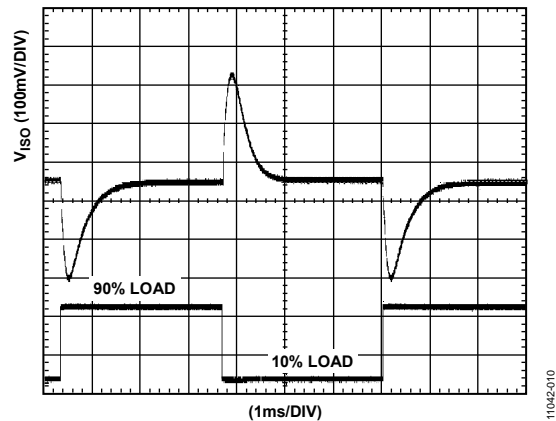

Figure 10. Typical V_{iso} Transient Load Response, 5 V Output, 10% to 90% Load Step



Figure 8. Typical Isolated Output Supply Current, I_{iso} , as a Function of External Load at 5 V/5 V, 3.3 V/3.3 V, and 5 V/3.3 V

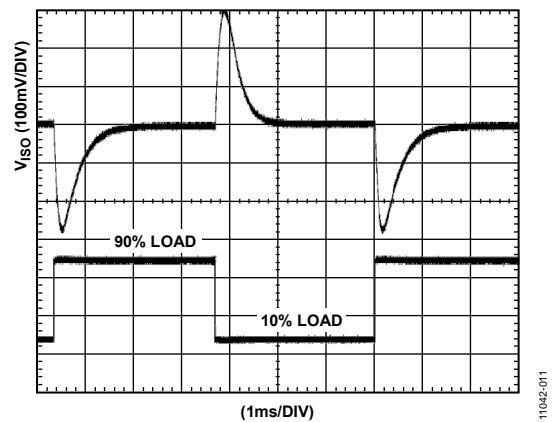

Figure 11. Typical Transient Load Response, 3 V Output, 10% to 90% Load Step

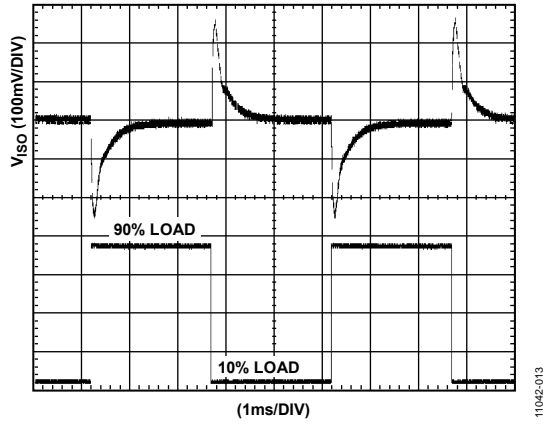

Figure 12. Typical Transient Load Response, 5 V Input, 3.3 V Output, 10% to 90% Load Step

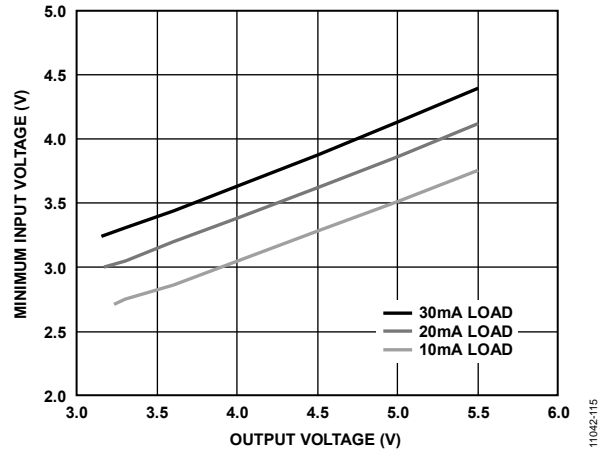

Figure 15. Relationship Between Output Voltage and Required Input Voltage, Under Load, to Maintain >80% Duty Factor in the PWM

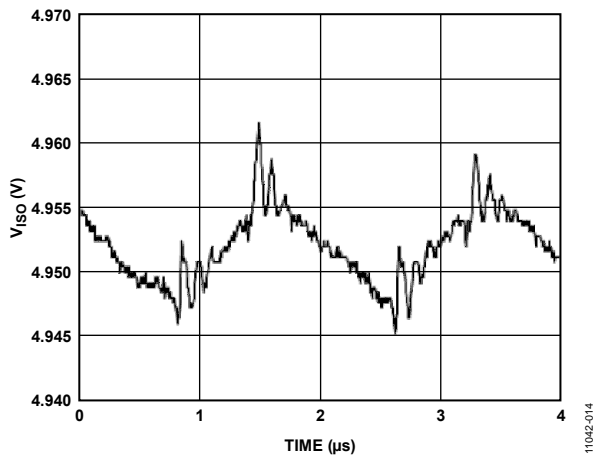

Figure 13. Typical $V_{ISO} = 5\text{ V}$ Output Voltage Ripple at 90% Load

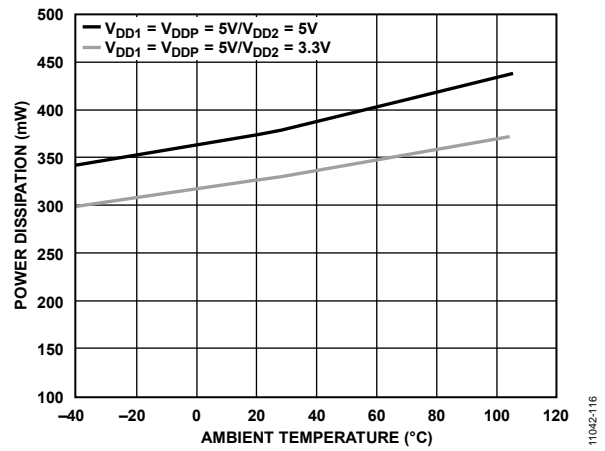

Figure 16. Power Dissipation with a 30 mA Load vs. Temperature



Figure 14. Typical $V_{ISO} = 3.3\text{ V}$ Output Voltage Ripple at 90% Load



Figure 17. Power Dissipation with a 20 mA Load vs. Temperature



Figure 18. Typical Supply Current per Input Channel vs. Data Rate for 5 V and 3.3 V Operation (No Output Load)

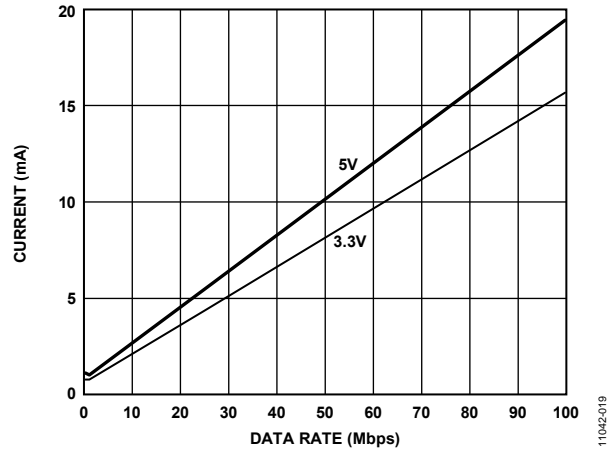

Figure 21. Typical ADuM6210 V_{DD1} or ADuM6212 V_{DD2} Supply Current vs. Data Rate for 5 V and 3.3 V Operation



Figure 19. Typical Supply Current per Output Channel vs. Data Rate for 5 V and 3.3 V Operation (No Output Load)

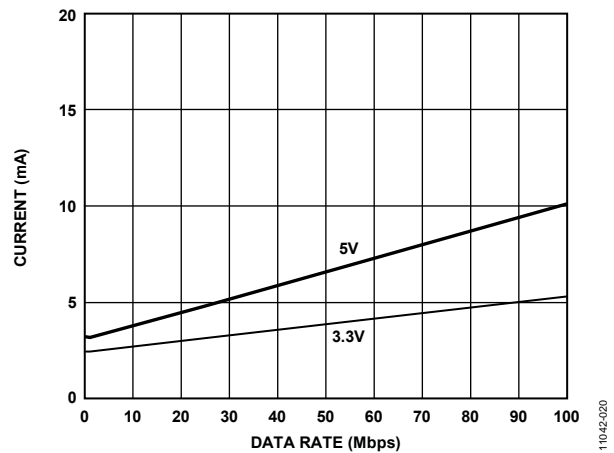

Figure 22. Typical ADuM6210 V_{DD2} or ADuM6212 V_{DD2} Supply Current vs. Data Rate for 5 V and 3.3 V Operation



Figure 20. Typical Supply Current per Output Channel vs. Data Rate for 5 V and 3.3 V Operation (15 pF Output Load)

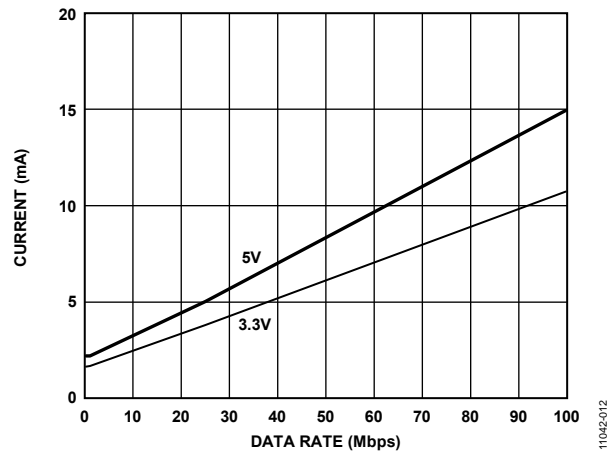

Figure 23. Typical ADuM6211 V_{DD1} or V_{DD2} Supply Current vs. Data Rate for 5 V and 3.3 V Operation

THERMAL ANALYSIS

The ADuM6210/ADuM6211/ADuM6212 consist of four internal die attached to a split lead frame with two die attach paddles. For the purposes of thermal analysis, the chip is treated as a thermal unit, with the highest junction temperature reflected in the θ_{JA} from Table 15. The value of θ_{JA} is based on measurements taken with the devices mounted on a JEDEC standard, 4-layer board with fine width traces and still air. Under normal operating conditions, the ADuM6210/ADuM6211/ADuM6212 can operate at full load across the full temperature range without derating the output current.

PROPAGATION DELAY PARAMETERS

Propagation delay is a parameter that describes the time it takes a logic signal to propagate through a component (see Figure 27). The propagation delay to a logic low output may differ from the propagation delay to a logic high.



Figure 27. Propagation Delay Parameters

Pulse width distortion is the maximum difference between these two propagation delay values and is an indication of how accurately the input signal timing is preserved.

Channel-to-channel matching refers to the maximum amount the propagation delay differs between channels within a single ADuM6210/ADuM6211/ADuM6212 component.

Propagation delay skew refers to the maximum amount the propagation delay differs between multiple ADuM6210/ADuM6211/ADuM6212 devices operating under the same conditions.

EMI CONSIDERATIONS

The dc-to-dc converter section of the ADuM6210/ADuM6211/ADuM6212 components must, of necessity, operate at a very high frequency to allow efficient power transfer through the small transformers. This creates high frequency currents that can propagate in circuit board ground and power planes, causing edge and dipole radiation. Grounded enclosures are recommended for applications that use these devices. If grounded enclosures are not possible, follow good RF design practices in the layout of the PCB. See the AN-0971 Application Note for the most current PCB layout recommendations for the ADuM6210/ADuM6211/ADuM6212.

DC CORRECTNESS AND MAGNETIC FIELD IMMUNITY

Positive and negative logic transitions at the isolator input cause narrow (~1 ns) pulses to be sent to the decoder via the transformer. The decoder is bistable and is, therefore, either set or reset by the pulses, indicating input logic transitions. In the absence of logic transitions at the input for more than 1.6 μ s, periodic sets of refresh pulses that are indicative of the correct input state are sent to ensure dc correctness at the output. If the decoder receives no internal pulses of more than approximately 6.4 μ s, the input side is assumed to be unpowered or nonfunctional, in which case, the isolator output is forced to a default low state by the watchdog timer circuit. This situation should occur in the ADuM6210/ADuM6211/ADuM6212 only during power-up and power-down operations.

The limitation on the ADuM6210/ADuM6211/ADuM6212 magnetic field immunity is set by the condition in which induced voltage in the transformer receiving coil is sufficiently large to either falsely set or reset the decoder. The following analysis defines the conditions under which this can occur. The 3.3 V operating condition of the ADuM6210/ADuM6211/ADuM6212 is examined because it represents the most susceptible mode of operation.

The pulses at the transformer output have an amplitude of >1.5 V. The decoder has a sensing threshold of about 0.5 V, thus establishing a 0.5 V margin in which induced voltages can be tolerated. The voltage induced across the receiving coil is given by

$$V = (-d\beta/dt)\sum\pi r_n^2; n = 1, 2, \dots, N$$

where:

β is the magnetic flux density (gauss).

r_n is the radius of the n^{th} turn in the receiving coil (cm).

N is the number of turns in the receiving coil.

Given the geometry of the receiving coil in the ADuM6210/ADuM6211/ADuM6212 and an imposed requirement that the induced voltage be, at most, 50% of the 0.5 V margin at the decoder, a maximum allowable magnetic field is calculated as shown in Figure 28.

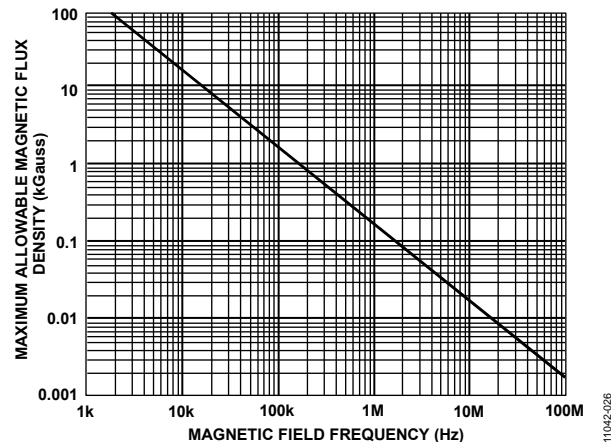

Figure 28. Maximum Allowable External Magnetic Flux Density

For example, at a magnetic field frequency of 1 MHz, the maximum allowable magnetic field of 0.2 kgauss induces a voltage of 0.25 V at the receiving coil. This is about 50% of the sensing threshold and does not cause a faulty output transition. Similarly, if such an event occurs during a transmitted pulse (and is of the worst-case polarity), it reduces the received pulse from >1.0 V to 0.75 V, which is still well above the 0.5 V sensing threshold of the decoder.

The preceding magnetic flux density values correspond to specific current magnitudes at given distances from the ADuM6210/ADuM6211/ADuM6212 transformers. Figure 29 expresses these allowable current magnitudes as a function of frequency for selected distances. As shown in Figure 29, the ADuM6210/ADuM6211/ADuM6212 are extremely immune and can be affected only by extremely large currents operated at high frequency very close to the component. For the 1 MHz example, a 0.5 kA current, placed 5 mm away from the ADuM6210/ADuM6211/ADuM6212, is required to affect component operation.

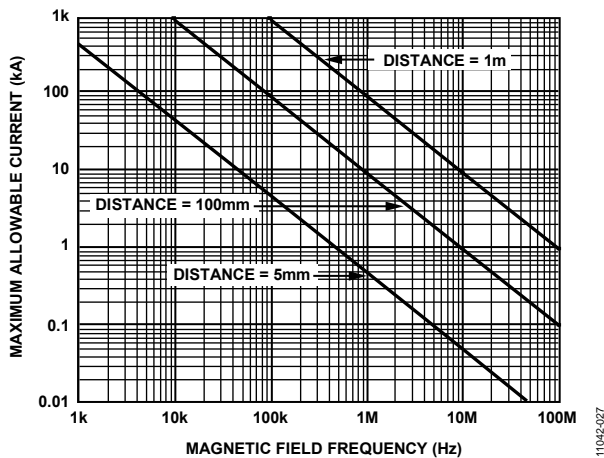

Figure 29. Maximum Allowable Current for Various Current-to-ADuM621x Spacings

Note that, in combinations of strong magnetic field and high frequency, any loops formed by PCB traces can induce error voltages that are sufficiently large to trigger the thresholds of succeeding circuitry. Exercise care in the layout of such traces to avoid this possibility.

POWER CONSUMPTION

The VDDP power supply input provides power only to the converter. Power for the data channels is provided through VDD1 and VDD2. These power supplies can be connected to VDDP and VISO, if desired; or the supplies can receive power from an independent source. The converter should be treated as a standalone supply to be utilized at the discretion of the designer.

The VDD1 or VDD2 supply current at a given channel of the ADuM6210/ADuM6211/ADuM6212 isolator is a function of the supply voltage, the data rate of the channel, and the output load of the channel.

For each input channel, the supply current is given by

$$I_{DDI} = I_{DDI(Q)} \quad f \leq 0.5 f_r$$

$$I_{DDI} = I_{DDI(D)} \times (2f - f_r) + I_{DDI(Q)} \quad f > 0.5 f_r$$

For each output channel, the supply current is given by

$$I_{DDO} = I_{DDO(Q)} \quad f \leq 0.5 f_r$$

$$I_{DDO} = (I_{DDO(D)} + (0.5 \times 10^{-3}) \times C_L \times V_{DDO}) \times (2f - f_r) + I_{DDO(Q)} \quad f > 0.5 f_r$$

where:

$I_{DDI(D)}$, $I_{DDO(D)}$ are the input and output dynamic supply currents per channel (mA/Mbps).

$I_{DDI(Q)}$, $I_{DDO(Q)}$ are the specified input and output quiescent supply currents (mA).

f is the input logic signal frequency (MHz); it is half the input data rate, expressed in units of Mbps.

f_r is the input stage refresh rate (Mbps).

C_L is the output load capacitance (pF).

V_{DDO} is the output supply voltage (V).

To calculate the total VDD1 and VDD2 supply current, the supply currents for each input and output channel corresponding to VDD1 and VDD2 are calculated and totaled. Figure 18 and Figure 19 show per-channel supply currents as a function of data rate for an unloaded output condition. Figure 20 shows the per-channel supply current as a function of data rate for a 15 pF output condition. Figure 21 through Figure 23 show the total VDD1 and VDD2 supply current as a function of data rate for ADuM6210/ADuM6211/ADuM6212 channel configurations.

INSULATION LIFETIME

All insulation structures eventually break down when subjected to voltage stress over a sufficiently long period. The rate of insulation degradation is dependent on the characteristics of the voltage waveform applied across the insulation. Analog Devices conducts an extensive set of evaluations to determine the lifetime of the insulation structure within the [ADuM6210/ADuM6211/ADuM6212](#).

Accelerated life testing is performed using voltage levels that are higher than the rated continuous working voltage. Acceleration factors for several operating conditions are determined, allowing calculation of the time to failure at the working voltage of interest. The values shown in Table 21 summarize the peak voltages for 50 years of service life in several operating conditions. In many cases, the working voltage approved by agency testing is higher than the 50-year service life voltage. Operation at working voltages that are higher than the service life voltage listed leads to premature insulation failure.

The insulation lifetime of the [ADuM6210/ADuM6211/ADuM6212](#) depends on the voltage waveform type imposed across the isolation barrier. The *iCoupler* insulation structure degrades at different rates, depending on whether the waveform is bipolar ac, unipolar ac, or dc. Figure 30, Figure 31, and Figure 32 illustrate these different isolation voltage waveforms.

Bipolar ac voltage is the most stringent environment. A 50-year operating lifetime under the bipolar ac condition determines the Analog Devices recommended maximum working voltage.

In the case of dc or unipolar ac voltage, the stress on the insulation is significantly lower. This allows operation at higher working voltages while still achieving a 50-year service life. The working voltages listed in Table 21 can be applied while maintaining the 50-year minimum lifetime, provided that the voltage conforms to either the dc or unipolar ac voltage cases. Any cross-insulation voltage waveform that does not conform to Figure 31 or Figure 32 must be treated as a bipolar ac waveform, and its peak voltage must be limited to the 50-year lifetime voltage value listed in Table 21.

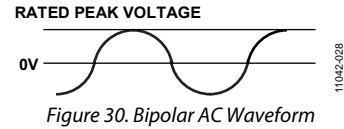

Figure 30. Bipolar AC Waveform

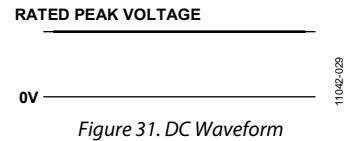
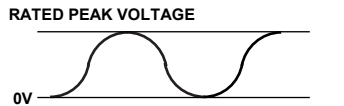

Figure 31. DC Waveform



NOTES
 1. THE VOLTAGE IS SHOWN AS SINUSOIDAL FOR ILLUSTRATION PURPOSES ONLY. IT IS MEANT TO REPRESENT ANY VOLTAGE WAVEFORM VARYING BETWEEN 0V AND SOME LIMITING VALUE. THE LIMITING VALUE CAN BE POSITIVE OR NEGATIVE, BUT THE VOLTAGE CANNOT CROSS 0V.

Figure 32. Unipolar AC Waveform