

FEATURES

- Single, in plane axis accelerometer with analog output**
- Full-scale range: $\pm 200\text{ g}$**
- Linear frequency response range: dc to 15 kHz typical (3 dB point)**
- Resonant frequency: 28 kHz typical**
- Ultralow noise density: $45\ \mu\text{g}/\sqrt{\text{Hz}}$**
- Overrange sensing plus dc coupling allows fast recovery time**
- Complete electromechanical self test**
- Sensitivity performance**
 - Sensitivity stability over temperature within $\pm 5\%$**
 - Linearity to $\pm 0.2\%$ of full-scale range**
 - Cross axis sensitivity: $\pm 1\%/\pm 0.8\%$ (z-axis acceleration effect on x-axis, y-axis acceleration effect on x-axis)**
- Single-supply operation**
 - Output voltage ratiometric to supply**
 - Low power consumption: 1.0 mA typical**
 - Power saving standby operation mode with fast recovery**
- RoHS compliant**
- -40°C to $+125^\circ\text{C}$ operating temperature range**
- 32-lead, 5 mm \times 5 mm \times 1.8 mm LFCSP package**

APPLICATIONS

- Condition monitoring**
- Predictive maintenance**
- Asset health**
- Test and measurement**
- Health usage monitoring systems (HUMSs)**
- Acoustic emissions**

GENERAL DESCRIPTION

The ADXL1003 delivers ultralow noise density over an extended frequency range and is optimized for bearing fault detection and diagnostics. The ADXL1003 has typical noise density of $45\ \mu\text{g}/\sqrt{\text{Hz}}$ across the linear frequency range. Microelectromechanical systems (MEMS) accelerometers have stable and repeatable sensitivity, and are immune to external shocks of up to 10,000 g.

FUNCTIONAL BLOCK DIAGRAM

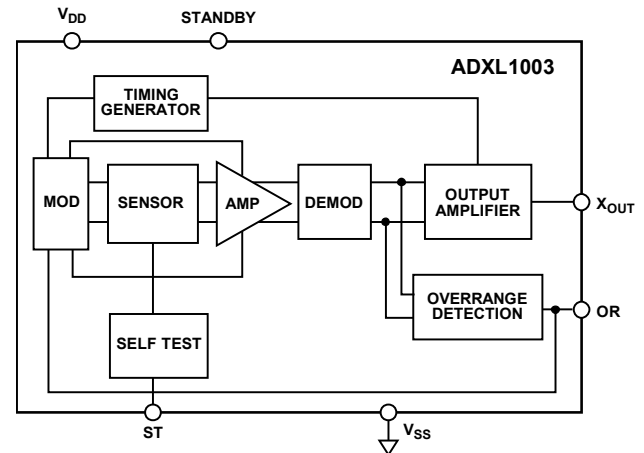

Figure 1.

16598-001

The integrated signal conditioning electronics enable such features as full electrostatic self test (ST) and an overrange (OR) indicator, useful for embedded applications. With low power and single-supply operation of 3.0 V to 5.25 V, the ADXL1003 also enables wireless sensing product design. The ADXL1003 is available in a 5 mm \times 5 mm \times 1.8 mm LFCSP package, and operates over the -40°C to $+125^\circ\text{C}$ temperature range.

TABLE OF CONTENTS

Features	1	Operating Modes.....	9
Applications.....	1	Bandwidth	9
Functional Block Diagram	1	Applications Information	10
General Description	1	Application Circuit.....	10
Revision History	2	On Demand Self Test	10
Specifications.....	3	Ratiometric Output Voltage.....	10
Absolute Maximum Ratings.....	4	Interfacing Analog Output Below 10 kHz	11
Thermal Resistance	4	Interfacing Analog Output Beyond 10 kHz.....	12
Recommended Soldering Profile	4	Overrange.....	13
ESD Caution.....	4	Mechanical Considerations for Mounting.....	13
Pin Configuration and Function Descriptions.....	5	Layout and Design Recommendations	13
Typical Performance Characteristics	6	Outline Dimensions	14
Theory of Operation	9	Ordering Guide	14
Mechanical Device Operation	9		

REVISION HISTORY

8/2018—Revision 0: Initial Version

SPECIFICATIONS

$T_A = 25^\circ\text{C}$, $V_{DD} = 5.0\text{ V}$, acceleration = 0 g, unless otherwise noted. All minimum and maximum specifications are guaranteed. Typical specifications may not be guaranteed.

Table 1.

Parameter	Test Conditions/Comments	Min	Typ	Max	Unit
SENSOR					
Measurement Range		± 200			g
Linearity ¹	Percentage of full-scale		± 0.2		%
Cross Axis Sensitivity ²	Z-axis acceleration effect on x-axis		± 0.8		%
	Y-axis acceleration effect on x-axis		± 1.0		%
SENSITIVITY (RATIOMETRIC TO V_{DD})					
Sensitivity ³	DC	9.2	10	10.8	mV/g
Sensitivity Change Due to Temperature ⁴	$T_A = -40^\circ\text{C}$ to $+125^\circ\text{C}$		± 5		%
ZERO g OFFSET (RATIOMETRIC TO V_{DD})					
0 g Output Voltage			$V_{DD}/2$		V
0 g Output Range over Temperature ⁵	-40°C to $+125^\circ\text{C}$		2		g
NOISE					
Noise Density	100 Hz to 14 kHz				
$V_{DD} = 5.0\text{ V}$			45		$\mu\text{g}/\sqrt{\text{Hz}}$
$V_{DD} = 3.0\text{ V}$			80		$\mu\text{g}/\sqrt{\text{Hz}}$
1/f Frequency Corner			0.1		Hz
FREQUENCY RESPONSE					
Sensor Resonant Frequency		24	28		kHz
5% Bandwidth ⁶			6.2		kHz
3 dB Bandwidth ⁷			15		kHz
SELF TEST					
Output Change (Ratiometric to V_{DD})	ST low to ST high	57	85		mV
Input Voltage Level					
High, V_{IH}		$V_{DD} \times 0.7$			V
Low, V_{IL}				$V_{DD} \times 0.3$	V
Input Current			25		μA
OUTPUT AMPLIFIER					
Short-Circuit Current			3		mA
Output Impedance			< 0.1		Ω
Maximum Capacitive Load ⁸	No series resistor		100		pF
	With series resistor		22		nF
POWER SUPPLY (V_{DD})					
Operating Voltage Range ³		3.0	5.0	5.25	V
Quiescent Supply Current			1.0	1.15	mA
Standby Current			225	285	μA
Standby Recovery Time (Standby to Measure Mode)	Output settled to 1% of final value		< 50		μs
Turn On Time ⁹			< 550		μs
OPERATING TEMPERATURE RANGE					
		-40		$+125$	$^\circ\text{C}$

¹ Linearity is tested using sine vibration at 13 kHz.

² Cross axis sensitivity is defined as the coupling of excitation along a perpendicular axis onto the measured axis output.

³ Parameter limits are based on characterization data or are guaranteed by design.

⁴ Includes package hysteresis from 25°C .

⁵ Difference between the maximum and the minimum values in temperature range.

⁶ Specified as a frequency range that is within a deviation range relative to dc sensitivity. The range is limited by an increase in response due to response gain at the sensor resonant frequency.

⁷ Specified as a frequency range that is within a deviation range relative to dc sensitivity. The range is limited by an increase in response due to response gain at the sensor resonant frequency.

⁸ For capacitive loads larger than 100 pF, an external series resistor must be connected (minimum 8 k Ω). The output capacitance must not exceed 22 nF.

⁹ Measured time difference from the instant V_{DD} reaches half its value to the instant at which the output settles to 1% of its final value.

ABSOLUTE MAXIMUM RATINGS

Table 2.

Parameter	Rating
Acceleration Any Axis, Powered or Unpowered	10,000 g
Drop Test (Concrete Surface)	1.2 m
V _{DD}	-0.3 V to +5.5 V
Output Short-Circuit Duration (Any Pin to Common Ground)	Indefinite
Temperature Range (Storage)	-55°C to +150°C

Stresses at or above those listed under Absolute Maximum Ratings may cause permanent damage to the product. This is a stress rating only; functional operation of the product at these or any other conditions above those indicated in the operational section of this specification is not implied. Operation beyond the maximum operating conditions for extended periods may affect product reliability.

THERMAL RESISTANCE

Thermal performance is directly linked to printed circuit board (PCB) design and operating environment. Careful attention to PCB thermal design is required.

θ_{JA} is the natural convection junction to ambient thermal resistance measured in a one cubic foot sealed enclosure.

θ_{JC} is the junction to case thermal resistance.

Table 3. Package Characteristics

Package Type	θ_{JA}	θ_{JC}	Device Weight
CP-32-26 ¹	48°C/W	14.1°C/W	<0.2 g

¹ Thermal impedance simulated values are based on a JEDEC 252P thermal test board with nine thermal vias. See JEDEC JESD51.

RECOMMENDED SOLDERING PROFILE

Figure 2 and Table 4 provide details about the recommended soldering profile.

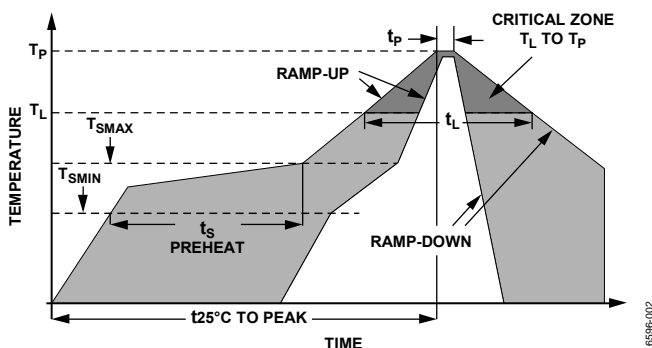

Figure 2. Recommended Soldering Profile

Table 4. Recommended Soldering Profile

Profile Feature	Condition	
	Sn63/Pb37	Pb-Free
Average Ramp Rate (T _L to T _P)	3°C/sec maximum	3°C/sec maximum
Preheat		
Minimum Temperature (T _{S MIN})	100°C	150°C
Maximum Temperature (T _{S MAX})	150°C	200°C
Time (T _{S MIN} to T _{S MAX})(t _S)	60 sec to 120 sec	60 sec to 180 sec
T _{S MAX} to T _L		
Ramp-Up Rate	3°C/sec maximum	3°C/sec maximum
Time Maintained Above Liquidous (T _L)		
Liquidous Temperature (T _L)	183°C	217°C
Time (t _L)	60 sec to 150 sec	60 sec to 150 sec
Peak Temperature (T _P)	240 + 0/-5°C	260 + 0/-5°C
Time Within 5°C of Actual Peak Temperature (t _P)	10 sec to 30 sec	20 sec to 40 sec
Ramp-Down Rate	6°C/sec maximum	6°C/sec maximum
Time 25°C to Peak Temperature (t _{25°C})	6 min maximum	8 min maximum

ESD CAUTION



ESD (electrostatic discharge) sensitive device. Charged devices and circuit boards can discharge without detection. Although this product features patented or proprietary protection circuitry, damage may occur on devices subjected to high energy ESD. Therefore, proper ESD precautions should be taken to avoid performance degradation or loss of functionality.

PIN CONFIGURATION AND FUNCTION DESCRIPTIONS

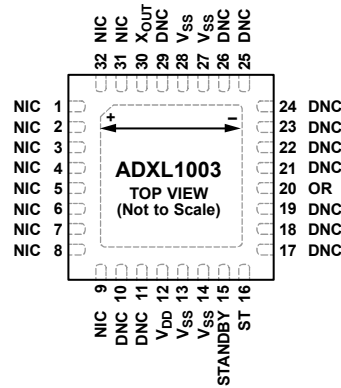

- NOTES**
1. NIC = NOT INTERNALLY CONNECTED.
 2. DNC = DO NOT CONNECT. LEAVE THIS PIN UNCONNECTED.
 3. EXPOSED PAD. THE EXPOSED PAD ON THE BOTTOM OF THE PACKAGE MUST BE CONNECTED TO GROUND AND IS REQUIRED FOR BOTH ELECTRICAL AND MECHANICAL PERFORMANCE.
 4. AXIS OF SENSITIVITY IS IN PLANE TO THE PACKAGE AND HORIZONTAL AS SHOWN.

16596-003

Figure 3. Pin Configuration

Table 5. Pin Function Descriptions

Pin No.	Mnemonic	Description
1 to 9, 31, 32	NIC	Not Internally Connected.
10, 11, 17 to 19, 21 to 26, 29	DNC	Do Not Connect. Leave this pin unconnected.
12	V _{DD}	3.0 V to 5.25 V Supply Voltage.
13, 14, 27, 28	V _{SS}	Supply Ground.
15	STANDBY	Standby Mode Input, Active High.
16	ST	Self Test Input, Active High.
20	OR	Overrange Output. This pin instantaneously indicates when the overrange detection circuit identifies significant overrange activity. This pin is not latched.
30	X _{OUT}	Analog Output Voltage.
	EPAD	Exposed Pad. The exposed pad on the bottom of the package must be connected to ground and is required for both electrical and mechanical performance.

TYPICAL PERFORMANCE CHARACTERISTICS

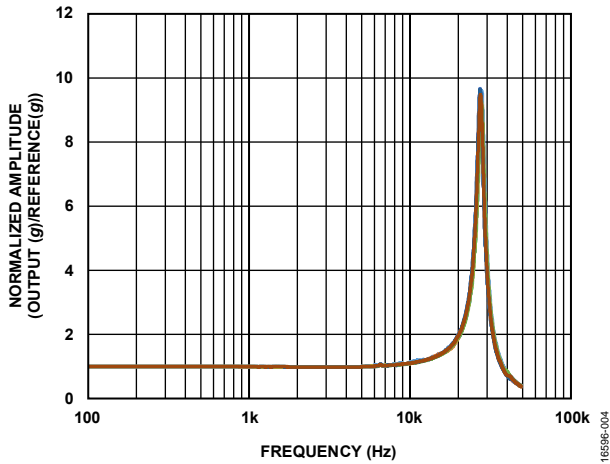

Figure 4. Frequency Response, High Frequency (>5 kHz) Vibration Response; a Laser Vibrometer Controller Referencing the ADXL1003 Package Used for Accuracy

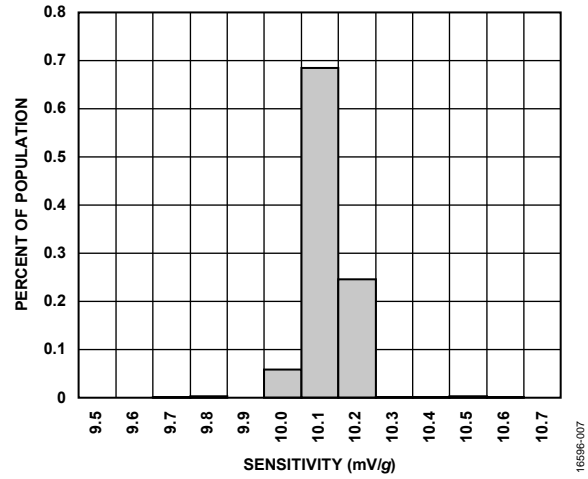

Figure 7. Sensitivity Distribution at 25°C

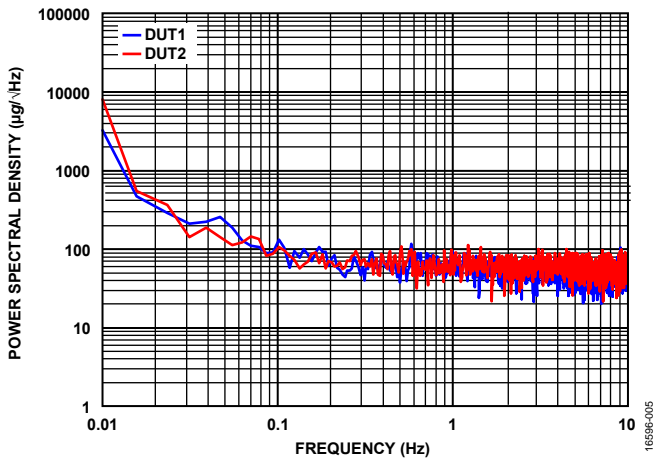

Figure 5. Noise Power Spectral Density (PSD) Below 10 Hz vs. Frequency

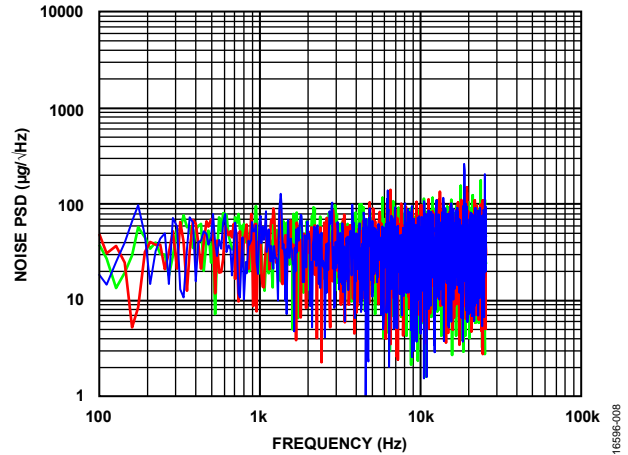

Figure 8. Noise PSD Above 100 Hz

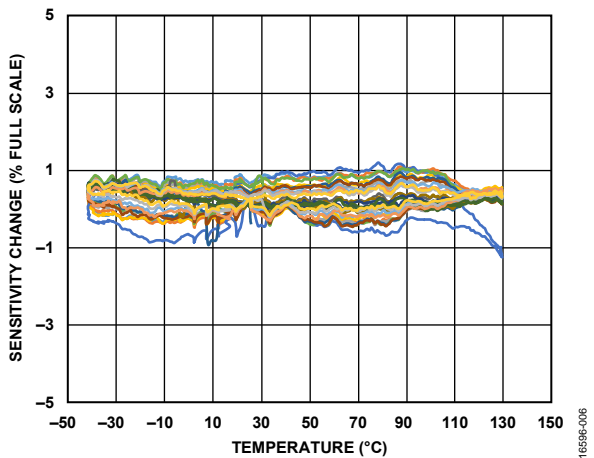

Figure 6. Sensitivity vs. Temperature

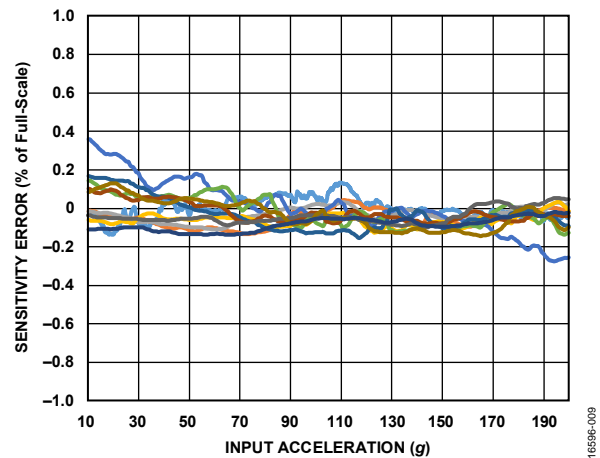

Figure 9. Sensitivity Nonlinearity vs. Input Acceleration

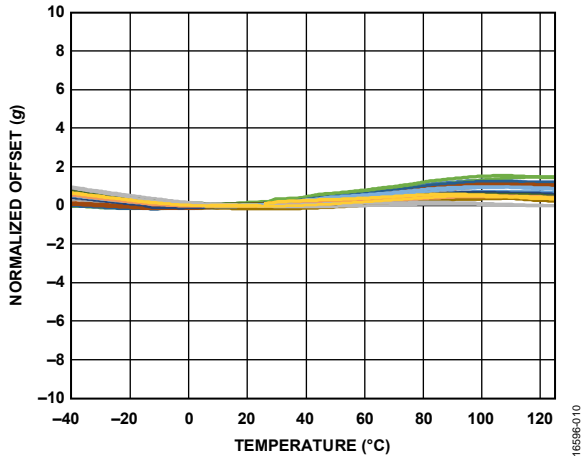

Figure 10. Normalized Offset vs. Temperature

16598-010

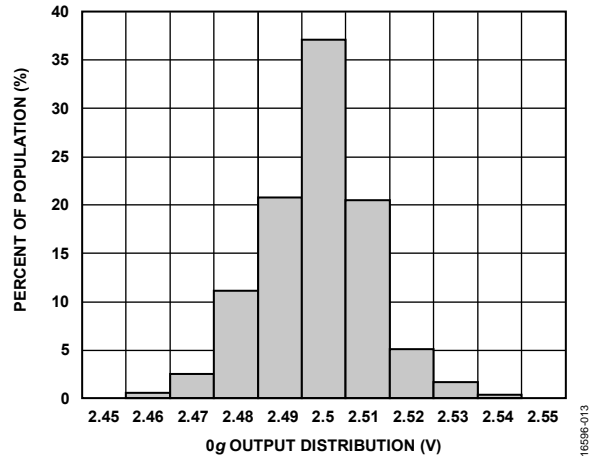

Figure 13. 0 g Offset Histogram at 25°C

16598-013

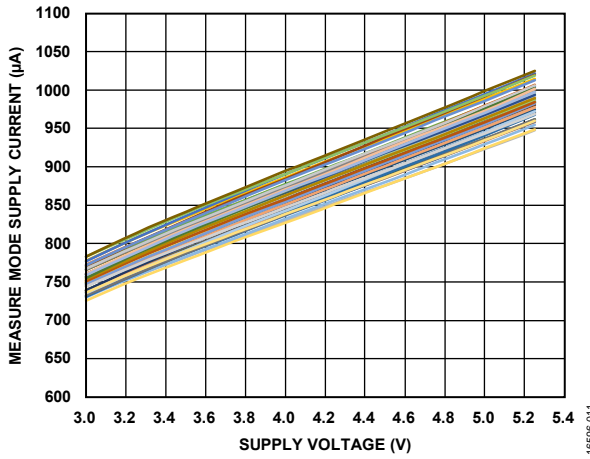

Figure 11. Measure Mode Supply Current vs. Supply Voltage

16598-011

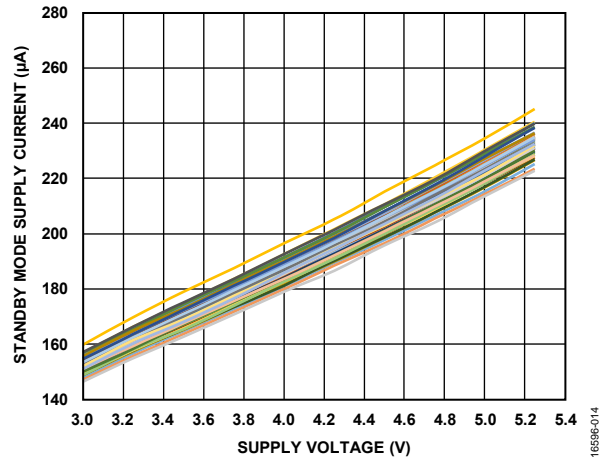

Figure 14. Standby Current vs. Supply Voltage

16598-014

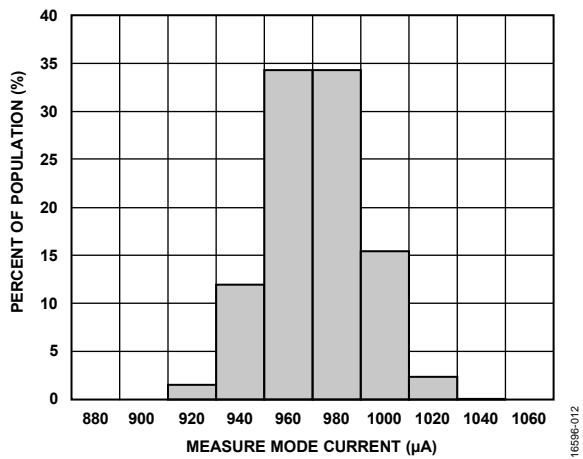

Figure 12. Measure Mode Current Histogram at 25°C

16598-012

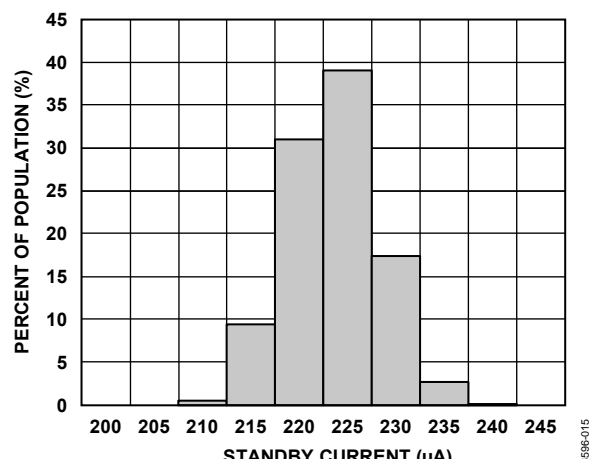

Figure 15. Standby Current Histogram at 25°C

16598-015

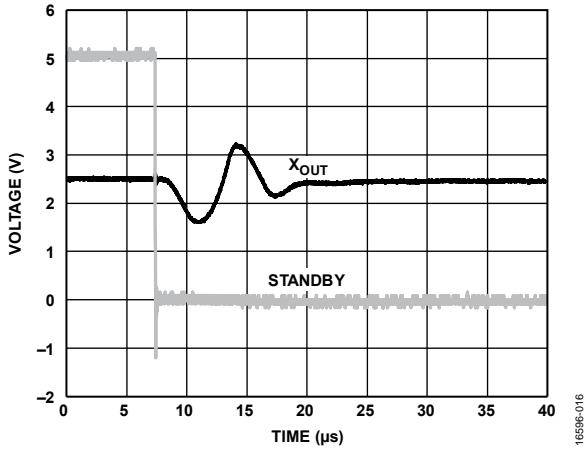

Figure 16. X_{OUT} Output Recovery from Standby Mode to Measure Mode

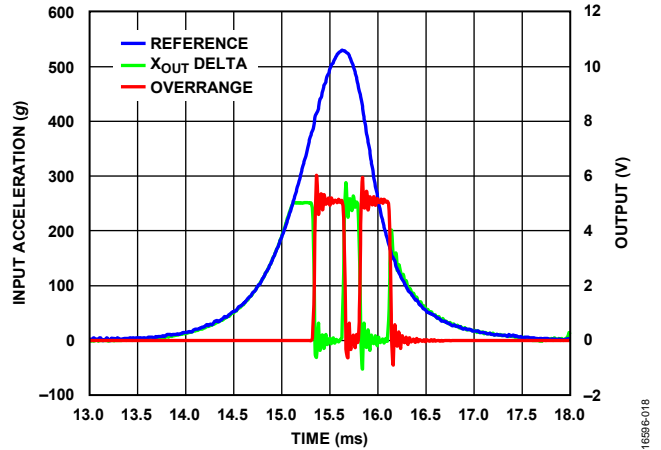

Figure 18. Response to Overload Condition, X_{OUT} Delta is Difference from Midscale Voltage

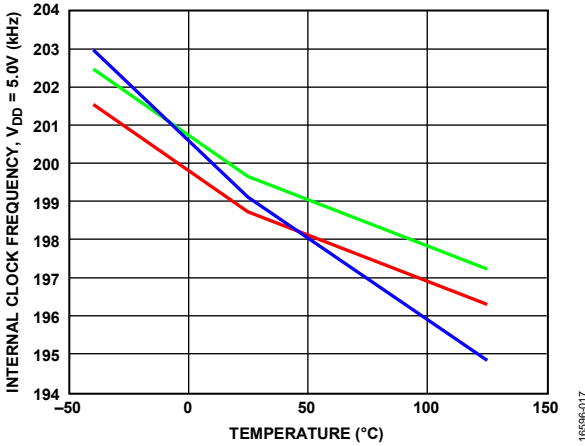

Figure 17. Internal Clock Frequency vs. Temperature at 5.0V Supply Voltage (V_{DD})

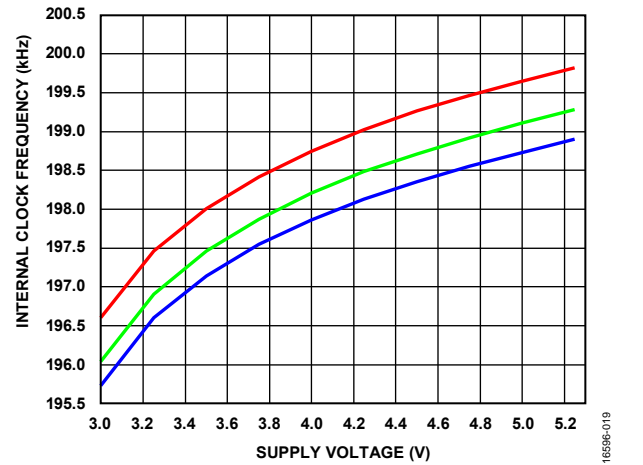

Figure 19. Internal Clock Frequency vs. Supply Voltage at 25°C

THEORY OF OPERATION

The ADXL1003 is a low noise, single-axis, MEMS accelerometer, with a 28 kHz resonant frequency that provides an analog output proportional to mechanical vibration. The ADXL1003 has a high g range of $\pm 200 g$, suitable for vibration measurements in high bandwidth applications. Such applications include vibration analysis systems for monitoring and diagnosing machines or system health.

The low noise and high frequency bandwidth allows the measurement of vibration patterns caused by small moving components, such as internal bearings. The high g range provides the dynamic range necessary for in high vibration environments such as heating, ventilation, and air conditioning (HVAC) and heavy machine equipment. To achieve proper performance, be aware of system noise, mounting, and signal conditioning.

System noise is affected by supply voltage noise. The analog output of the ADXL1003 is a ratiometric output. Therefore, supply voltage modulation affects the output. Use a properly decoupled, stable supply voltage to power the ADXL1003 and to provide a reference voltage for the digitizing system.

The output signal is impacted by an overrange stimulus. An overload indicator output feature indicates a condition that is critical for an intelligent measurement system. For more information about the overrange features, see the Overrange section.

Proper mounting ensures full mechanical transfer of vibration to accurately measure the desired vibration rather than vibration of the measurement system, including the sensor. A common technique for high frequency mechanical coupling is to use a sensor stud mount system while considering the mechanical interface of fixing the ADXL1003 in the stud. For lower frequencies (below the full capable bandwidth of the sensor), it may be possible to use magnetic or adhesive mounting. Proper mounting technique ensures proper and repeatable results that are not influenced by measurement system mechanical resonances and/or damping at the desired frequency, and represents an efficient and proper mechanical transfer to the system being monitored.

Proper application specific signal conditioning is required to achieve optimal results. Understanding the measurement frequency range and managing overload conditions is important to achieve accurate results. The electrical output signal of the ADXL1003 requires some band limiting and a proper digitization bandwidth. See the Interfacing Analog Output Below 10 kHz section and the Interfacing Analog Output Beyond 10 kHz section for more information.

MECHANICAL DEVICE OPERATION

The moving component of the sensor is a polysilicon surface-micromachined structure built on top of a silicon wafer. Polysilicon springs suspend the structure over the surface of the wafer and provide a resistance against acceleration forces.

Differential capacitors that consist of independent fixed plates and plates attached to the moving mass measure the deflection of the structure. Acceleration deflects the structure and unbalances the differential capacitor, resulting in a sensor output with amplitude proportional to acceleration. Phase sensitive demodulation determines the magnitude and polarity of the acceleration.

OPERATING MODES

The ADXL1003 has two operating modes: measure mode and standby mode. Measure mode provides a continuous analog output for active monitoring. Standby mode is a nonoperational, low power mode.

Measure Mode

Measure mode is the normal operating mode of the ADXL1003. In this mode, the accelerometer actively measures acceleration along the axis of sensitivity and consumes 1.0 mA (typical) using a 5.0 V supply.

Standby Mode

Placing the ADXL1003 in standby mode suspends the measurement and reduces the internal current consumption to 225 μ A (typical for the 5.0 V supply). The transition time from standby to measure mode is $< 50 \mu$ s. Figure 16 shows the transition from standby to measure mode.

BANDWIDTH

The ADXL1003 circuitry supports an output signal bandwidth beyond the resonant frequency of the sensor, measuring acceleration over a bandwidth comparable to the resonant frequency of the sensor. The output response is a combination of the sensor response and the output amplifier response. Therefore, external band limiting or filtering is required. See the Interfacing Analog Output Below 10 kHz section and the Interfacing Analog Output Beyond 10 kHz section for more information.

When using the ADXL1003 beyond 10 kHz, consider the nonlinearity due to the resonance frequency of the sensor, the additional noise due to the wideband output of the amplifier, and the discrete frequency spurious tone due to coupling of the internal 200 kHz clock. Aliased interferers in the desired band cannot be removed, and observed performance degrades. A combination of high speed sampling and appropriate band limiting filtering is required for optimal performance.

APPLICATIONS INFORMATION

APPLICATION CIRCUIT

For most applications, a single 1 μF capacitor adequately decouples the accelerometer from noise on the power supply. A band limiting filter at the output provides suppression of out of band noise and signal. A capacitive load between 100 pF and 22 nF is recommended.

The output amplifier can drive resistive loads up to 2 mA of source current, for example a load greater than 2.5 k Ω for 5 V operation. If the output is to drive a capacitive load greater than or equal to 100 pF, a series resistor of at least 8 k Ω is required to maintain the amplifier stability.

When inactive, the ST and STANDBY pins are forced low. The overrange indicator is an output that can be monitored to identify the status of the system.

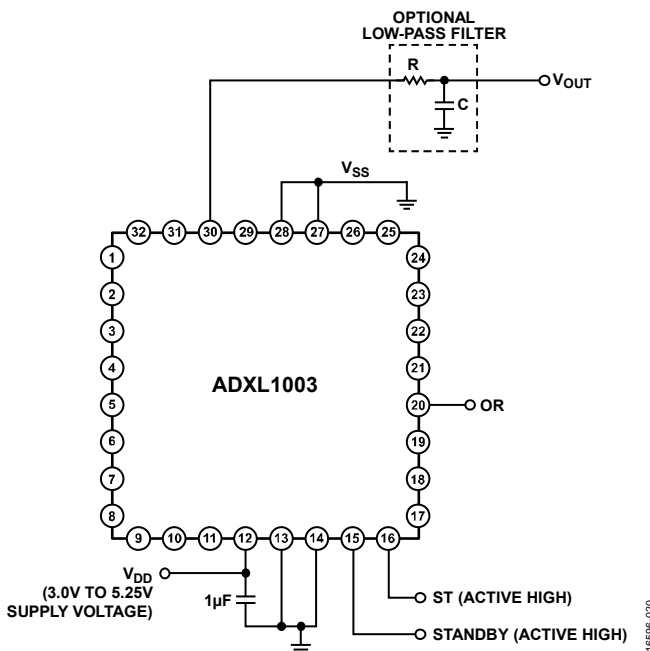

Figure 20. Application Circuit

ON DEMAND SELF TEST

A fully integrated electromechanical self test function is designed into the ADXL1003. This function electrostatically actuates the accelerometer proof mass, resulting in a displacement of the capacitive sense fingers. This displacement is equivalent to the displacement that occurs as a result of external acceleration input. The proof mass displacement is processed by the same signal processing circuitry as a true acceleration output signal, providing complete coverage of both the electrical and mechanical responses of the sensor system.

The self test feature can be exercised by the user with the following steps:

1. Measure the output voltage.
2. Turn on self test by setting the ST pin to V_{DD} .
3. Measure the output again.

4. Subtract the two readings and compare the result to the expected value from Table 1, while factoring in the response curve due to supply voltage, if necessary, from Figure 21.

The self test function can be activated at any point during normal operation by setting the ST pin to V_{DD} . Self test takes approximately 300 μs from the assertion of the ST pin to a result. Acceleration outputs return approximately 300 μs after the release of the ST pin. While performing the self test measurement, do not use the accelerometer output to measure external acceleration.

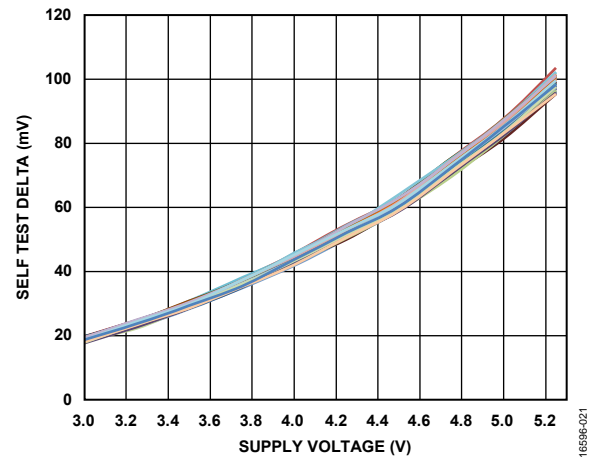

Figure 21. Typical Self Test Delta vs. Supply Voltage

RATIOMETRIC OUTPUT VOLTAGE

The ADXL1003 was tested and specified at $V_{DD} = 5.0\text{ V}$. However, the ADXL1003 can be powered with V_{DD} as low as 3.0 V or as high as 5.25 V. Some performance parameters change as the supply voltage is varied.

The ADXL1003 output is ratiometric to the supply voltage, V_{DD} . Therefore, the output sensitivity (or scale factor) varies proportionally to the supply voltage. At $V_{DD} = 5.0\text{ V}$, the output sensitivity is typically 10 mV/g for the ADXL1003. The zero g bias output is ratiometric also and is nominally midscale relative to the supply voltage ($V_{DD}/2$).

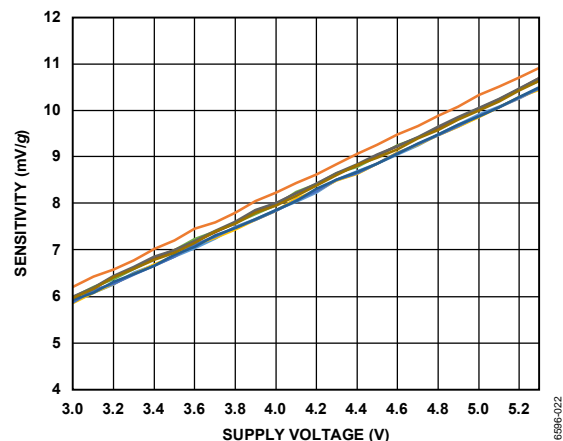

Figure 22. Sensitivity vs. Supply Voltage

INTERFACING ANALOG OUTPUT BELOW 10 kHz

The ADXL1003 senses mechanical motion along a single axis and produces a voltage output. The system performance depends on the output response resulting from sense mechanical vibration and signal processing of the electrical output.

The sensor must be effectively mechanically coupled. Mechanical coupling can be a complex integration of multiple components, typically unique for each application. Consideration must be made for all mechanical interfaces including the mounting of the MEMS to the PCB (the location on the PCB as well as the solder chemistry), the size of the PCB (both thickness and active surface area), and the mounting of the PCB to the system being monitored (either in a module or directly mounted).

In general, the following guidelines for effective mechanical interface must be used to support up to 10 kHz bandwidth:

- Keep the ADXL1003 near a stable mechanical mounting on the PCB.
- Provide multiple hard mounting points.
- Keep the PCB thick and avoid a large surface area PCB that induces higher magnitude and lower frequency resonances.
- Ensure the mechanical connection is sufficiently stiff to transfer mechanical forces up to the desired frequency. Below 10 kHz, magnetic and adhesive mounting is possible with proper attention. The [EVAL-ADXL1003Z](#) evaluation boards can be used as a reference.

The ADXL1003 electrical output supports a bandwidth beyond the resonance of the sensor. The small signal bandwidth of the output amplifier in the ADXL1003 is 70 kHz. During the digitization process, aliasing (which is the folding of higher frequency noise and signals into the desired band) can occur. To avoid aliasing noise from the amplifier and other internal circuits (for example, coupling of the internal 200 kHz clock), it is recommended that an external filter be implemented at the desired bandwidth and the chosen analog-to-digital converter (ADC) sampling rate be faster than the amplifier bandwidth.

The output amplifier is ratiometric to the supply voltage, and there are two distinct cases regarding digital conversion, as follows:

- The user has an ADC downstream of the accelerometer that can use the V_{DD} voltage as a reference. In this case, the voltage supply tolerance and voltage temperature coefficient (commonly associated with external regulators) tracks between the sensor and the ADC. Therefore, the supply and reference voltage induced error cancels out. This design approach is recommended.
- If the ADC cannot reference the same 5 V supply as the sensor for any reason, the sensitivity of the digitized sensor output reflects the regulator tolerance and temperature coefficient.

The ADXL1003 output amplifier is stable while driving capacitive loads of up to 100 pF directly without a series resistor. At loads greater than 100 pF, an 8 k Ω or greater series resistor must be used.

See Figure 23 for an example of the interface, including components when measuring mechanical vibration from 0 kHz to 5 kHz. For a 5 kHz pass band, a single-pole resistor capacitor (RC) filter is acceptable. However, in some applications, use of a more aggressive filter and lower sample ADC sample rate is possible. The following components are recommended to form a 5 kHz low-pass RC filter at the output of the ADXL1003 when interfacing to an ADC, such as the [ADAQ7980](#): $R1 = 5\text{ k}\Omega$, $C1 = 5\text{ nF}$, $R2 = 0\ \Omega$, and $C2$ are not required. A minimum ADC sample rate of 20 kHz is recommended to avoid aliasing. When using sampling rates less than the resonance frequency (typically 28 kHz), be aware and account for the effective gain at the output of the sensor due to the resonance to ensure out of band signals are properly attenuated and do not alias into the band.

See Figure 23 for an example of the interface, including components when measuring mechanical vibration from 0 kHz to 10 kHz. The following components are recommended to form a two-pole RC filter at the output of the ADXL1003: $R1 = 5\text{ k}\Omega$, $C1 = 2\text{ nF}$, $R2 = 5\text{ k}\Omega$, and $C2 = 2\text{ nF}$. A minimum ADC sample rate of 200 kHz is recommended to avoid aliasing.

OVERRRANGE

The ADXL1003 has an output (OR pin) to signal when an overrange event (when acceleration is greater than 2× the full-scale range) occurs. Built in overrange detection circuitry provides an alert to indicate a significant overrange event occurred that is larger than approximately 2× the specified g range. When an overrange is detected, the internal clock is disabled to the sensor for 200 μs to maximize protection of the sensor element during an overrange event. If a sustained overrange event is encountered, the overrange detection circuitry triggers periodically, approximately every 500 μs (see Figure 18).

MECHANICAL CONSIDERATIONS FOR MOUNTING

Mount the ADXL1003 on the PCB in a location close to a hard mounting point of the PCB. Mounting the ADXL1003 at an unsupported PCB location, as shown in Figure 24 may result

in large, apparent measurement errors due to undamped PCB vibration. Placing the accelerometer near a hard mounting point ensures that any PCB vibration at the accelerometer is above the mechanical sensor resonant frequency of the accelerometer and effectively invisible to the accelerometer. Multiple mounting points, close to the sensor, and a thicker PCB help reduce the effect of system resonance on the performance of the sensor.

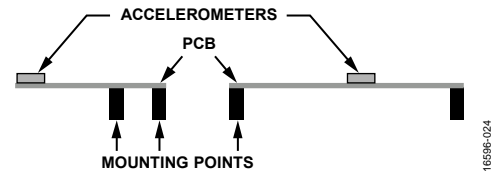

Figure 24. Incorrectly Placed Accelerometers

LAYOUT AND DESIGN RECOMMENDATIONS

Figure 25 shows the recommended PCB land pattern.

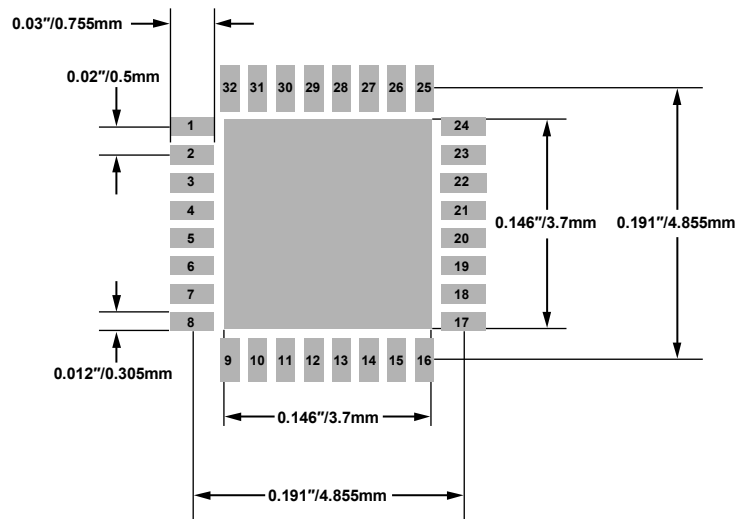

Figure 25. PCB Land Pattern