

FEATURES

- 3-axis sensing**
- Small, low profile package**
4 mm \times 4 mm \times 1.45 mm LFCSP
- Low power: 350 μ A typical**
- Single-supply operation: 1.8 V to 3.6 V**
- 10,000 g shock survival**
- Excellent temperature stability**
- Bandwidth adjustment with a single capacitor per axis**
- RoHS/WEEE lead-free compliant**

APPLICATIONS

- Cost-sensitive, low power, motion- and tilt-sensing applications**
 - Mobile devices
 - Gaming systems
 - Disk drive protection
 - Image stabilization
 - Sports and health devices

GENERAL DESCRIPTION

The ADXL327 is a small, low power, complete 3-axis accelerometer with signal conditioned voltage outputs. The product measures acceleration with a minimum full-scale range of $\pm 2 g$. It can measure the static acceleration of gravity in tilt-sensing applications, as well as dynamic acceleration, resulting from motion, shock, or vibration.

The user selects the bandwidth of the accelerometer using the C_X , C_Y , and C_Z capacitors at the X_{OUT} , Y_{OUT} , and Z_{OUT} pins. Bandwidths can be selected to suit the application with a range of 0.5 Hz to 1600 Hz for X and Y axes and a range of 0.5 Hz to 550 Hz for the Z axis.

The ADXL327 is available in a small, low profile, 4 mm \times 4 mm \times 1.45 mm, 16-lead, plastic lead frame chip scale package (LFCSP_LQ).

FUNCTIONAL BLOCK DIAGRAM

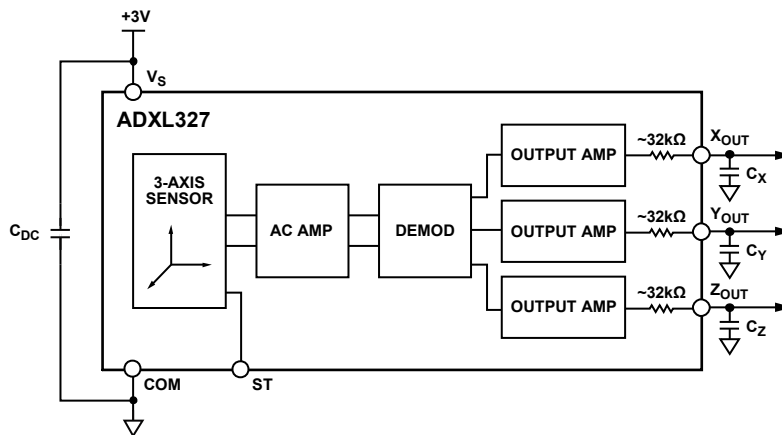

Figure 1.

Rev. 0

Information furnished by Analog Devices is believed to be accurate and reliable. However, no responsibility is assumed by Analog Devices for its use, nor for any infringements of patents or other rights of third parties that may result from its use. Specifications subject to change without notice. No license is granted by implication or otherwise under any patent or patent rights of Analog Devices. Trademarks and registered trademarks are the property of their respective owners.

TABLE OF CONTENTS

| | | | |
|--|----|--|----|
| Features | 1 | Performance | 10 |
| Applications..... | 1 | Applications Information | 11 |
| General Description | 1 | Power Supply Decoupling | 11 |
| Functional Block Diagram | 1 | Setting the Bandwidth Using C_x , C_y , and C_z | 11 |
| Revision History | 2 | Self Test | 11 |
| Specifications..... | 3 | Design Trade-Offs for Selecting Filter Characteristics: The Noise/BW Trade-Off..... | 11 |
| Absolute Maximum Ratings..... | 4 | Use with Operating Voltages Other Than 3 V | 11 |
| ESD Caution..... | 4 | Axes of Acceleration Sensitivity | 12 |
| Pin Configuration and Function Descriptions..... | 5 | Layout and Design Recommendations | 13 |
| Typical Performance Characteristics | 6 | Outline Dimensions | 14 |
| Theory of Operation | 10 | Ordering Guide | 14 |
| Mechanical Sensor..... | 10 | | |

REVISION HISTORY

8/09—Revision 0: Initial Version

SPECIFICATIONS

$T_A = 25^\circ\text{C}$, $V_S = 3\text{ V}$, $C_X = C_Y = C_Z = 0.1\ \mu\text{F}$, acceleration = 0 g, unless otherwise noted. All minimum and maximum specifications are guaranteed. Typical specifications are not guaranteed.

Table 1.

| Parameter | Conditions | Min | Typ | Max | Unit |
|--|-----------------------|---------|---------------|-------|------------------------------------|
| SENSOR INPUT | Each axis | | | | |
| Measurement Range | | ± 2 | ± 2.5 | | g |
| Nonlinearity | Percent of full scale | | ± 0.2 | | % |
| Package Alignment Error | | | ± 1 | | Degrees |
| Interaxis Alignment Error | | | ± 0.1 | | Degrees |
| Cross Axis Sensitivity ¹ | | | ± 1 | | % |
| SENSITIVITY (RATIOMETRIC) ² | Each axis | | | | |
| Sensitivity at X_{OUT} , Y_{OUT} , Z_{OUT} | $V_S = 3\text{ V}$ | 378 | 420 | 462 | mV/g |
| Sensitivity Change Due to Temperature ³ | $V_S = 3\text{ V}$ | | ± 0.01 | | %/ $^\circ\text{C}$ |
| ZERO g BIAS LEVEL (RATIOMETRIC) | | | | | |
| 0 g Voltage at X_{OUT} , Y_{OUT} | $V_S = 3\text{ V}$ | 1.3 | 1.5 | 1.7 | V |
| 0 g Voltage at Z_{OUT} | $V_S = 3\text{ V}$ | 1.2 | 1.5 | 1.8 | V |
| 0 g Offset vs. Temperature | | | ± 1 | | mg/ $^\circ\text{C}$ |
| NOISE PERFORMANCE | | | | | |
| Noise Density X_{OUT} , Y_{OUT} , Z_{OUT} | | | 250 | | $\mu\text{g}/\sqrt{\text{Hz}}$ rms |
| FREQUENCY RESPONSE ⁴ | | | | | |
| Bandwidth X_{OUT} , Y_{OUT} ⁵ | No external filter | | 1600 | | Hz |
| Bandwidth Z_{OUT} ⁵ | No external filter | | 550 | | Hz |
| R_{FILT} Tolerance | | | $32 \pm 15\%$ | | k Ω |
| Sensor Resonant Frequency | | | 5.5 | | kHz |
| SELF TEST ⁶ | | | | | |
| Logic Input Low | | | +0.6 | | V |
| Logic Input High | | | +2.4 | | V |
| ST Actuation Current | | | +60 | | μA |
| Output Change at X_{OUT} | Self test 0 to 1 | -210 | -450 | -850 | mV |
| Output Change at Y_{OUT} | Self test 0 to 1 | +210 | +450 | +850 | mV |
| Output Change at Z_{OUT} | Self test 0 to 1 | +210 | +770 | +1400 | mV |
| OUTPUT AMPLIFIER | | | | | |
| Output Swing Low | No load | | 0.1 | | V |
| Output Swing High | No load | | 2.8 | | V |
| POWER SUPPLY | | | | | |
| Operating Voltage Range | | 1.8 | | 3.6 | V |
| Supply Current | $V_S = 3\text{ V}$ | | 350 | | μA |
| Turn-On Time ⁷ | No external filter | | 1 | | ms |
| TEMPERATURE | | | | | |
| Operating Temperature Range | | -40 | | +85 | $^\circ\text{C}$ |

¹ Defined as coupling between any two axes.

² Sensitivity is essentially ratiometric to V_S .

³ Defined as the output change from ambient-to-maximum temperature or ambient-to-minimum temperature.

⁴ Actual frequency response controlled by user-supplied external filter capacitors (C_X , C_Y , C_Z).

⁵ Bandwidth with external capacitors = $1/(2 \times \pi \times 32\text{ k}\Omega \times C)$. For C_X , $C_Y = 0.003\ \mu\text{F}$, bandwidth = 1.6 kHz. For $C_Z = 0.01\ \mu\text{F}$, bandwidth = 500 Hz. For C_X , C_Y , $C_Z = 10\ \mu\text{F}$, bandwidth = 0.5 Hz.

⁶ Self test response changes cubically with V_S .

⁷ Turn-on time is dependent on C_X , C_Y , C_Z and is approximately $160 \times C_X$ or C_Y or $C_Z + 1\text{ ms}$, where C_X , C_Y , C_Z are in μF .

ABSOLUTE MAXIMUM RATINGS

Table 2.

| Parameter | Rating |
|--|-----------------------------------|
| Acceleration (Any Axis, Unpowered) | 10,000 <i>g</i> |
| Acceleration (Any Axis, Powered) | 10,000 <i>g</i> |
| V_s | -0.3 V to +3.6 V |
| All Other Pins | (COM - 0.3 V) to (V_s + 0.3 V) |
| Output Short-Circuit Duration (Any Pin to Common) | Indefinite |
| Temperature Range (Powered) | -55°C to +125°C |
| Temperature Range (Storage) | -65°C to +150°C |

Stresses above those listed under Absolute Maximum Ratings may cause permanent damage to the device. This is a stress rating only; functional operation of the device at these or any other conditions above those indicated in the operational section of this specification is not implied. Exposure to absolute maximum rating conditions for extended periods may affect device reliability.

ESD CAUTION



ESD (electrostatic discharge) sensitive device. Charged devices and circuit boards can discharge without detection. Although this product features patented or proprietary protection circuitry, damage may occur on devices subjected to high energy ESD. Therefore, proper ESD precautions should be taken to avoid performance degradation or loss of functionality.

PIN CONFIGURATION AND FUNCTION DESCRIPTIONS

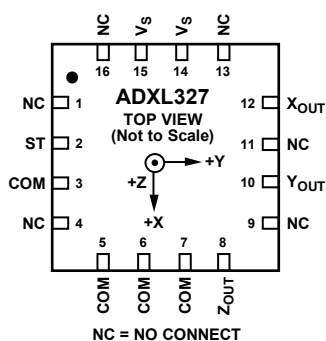

Figure 2. Pin Configuration

Table 3. Pin Function Descriptions

| Pin No. | Mnemonic | Description |
|---------|------------------|--|
| 1 | NC | No Connect (or Optionally Ground) |
| 2 | ST | Self Test |
| 3 | COM | Common |
| 4 | NC | No Connect |
| 5 | COM | Common |
| 6 | COM | Common |
| 7 | COM | Common |
| 8 | Z _{OUT} | Z Channel Output |
| 9 | NC | No Connect (or Optionally Ground) |
| 10 | Y _{OUT} | Y Channel Output |
| 11 | NC | No Connect |
| 12 | X _{OUT} | X Channel Output |
| 13 | NC | No Connect |
| 14 | V _S | Supply Voltage (1.8 V to 3.6 V) |
| 15 | V _S | Supply Voltage (1.8 V to 3.6 V) |
| 16 | NC | No Connect |
| EP | Exposed pad | Not internally connected. Solder for mechanical integrity. |

TYPICAL PERFORMANCE CHARACTERISTICS

N > 1000 for all typical performance plots, unless otherwise noted.

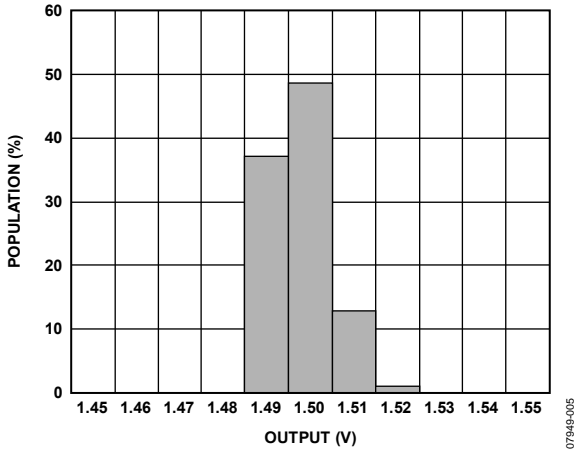

Figure 3. X-Axis Zero g Bias at 25°C, $V_s = 3 V$

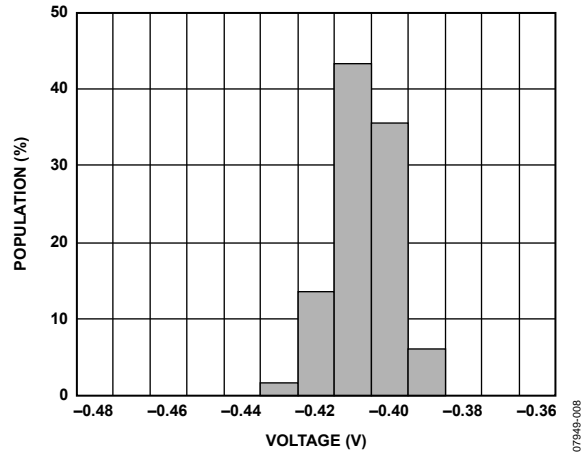

Figure 6. X-Axis Self Test Response at 25°C, $V_s = 3 V$

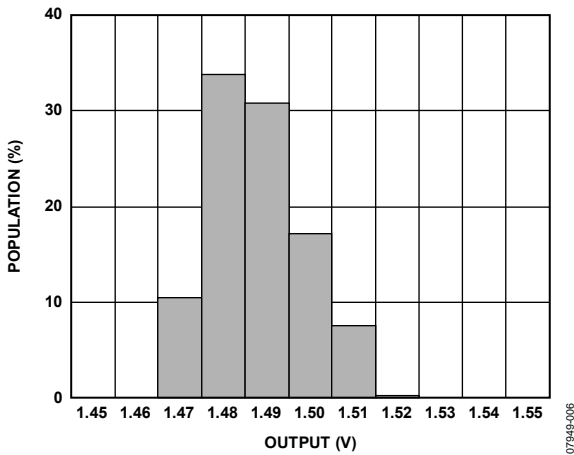

Figure 4. Y-Axis Zero g Bias at 25°C, $V_s = 3 V$

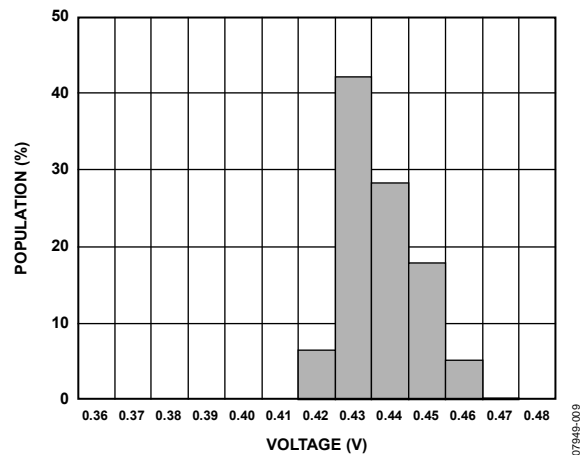

Figure 7. Y-Axis Self Test Response at 25°C, $V_s = 3 V$

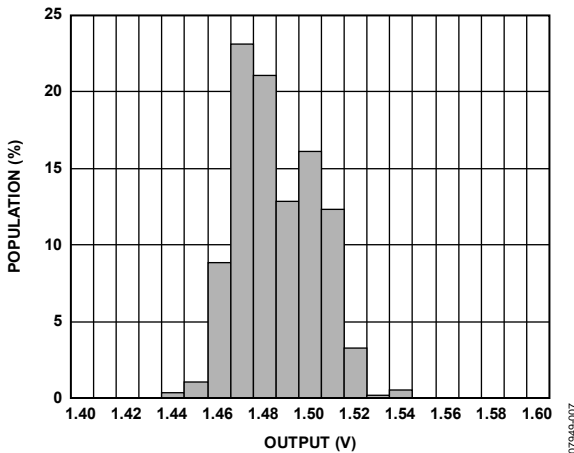

Figure 5. Z-Axis Zero g Bias at 25°C, $V_s = 3 V$

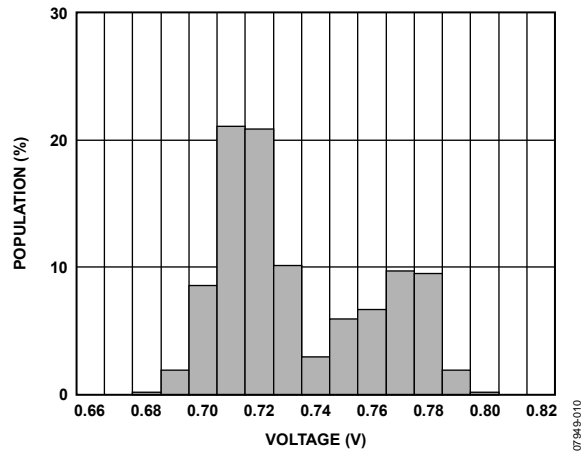

Figure 8. Z-Axis Self Test Response at 25°C, $V_s = 3 V$

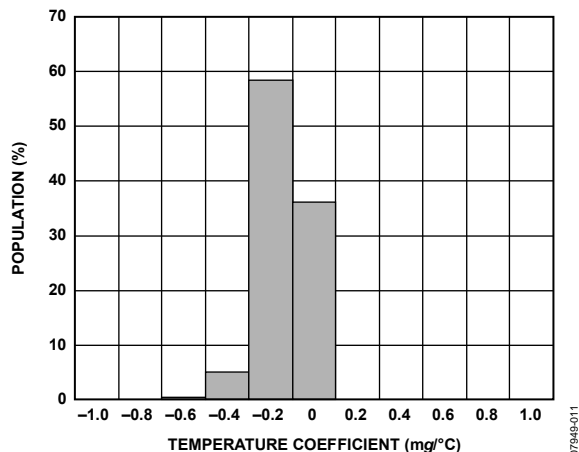

Figure 9. X-Axis Zero g Bias Temperature Coefficient, $V_S = 3\text{ V}$

07949-011

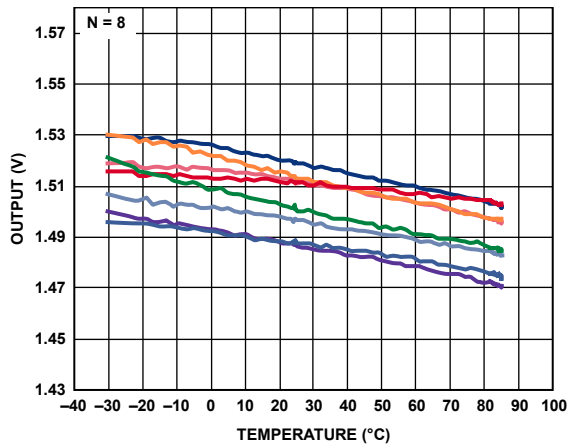

Figure 12. X-Axis Zero g Bias vs. Temperature, Eight Parts Soldered to PCB

07949-014

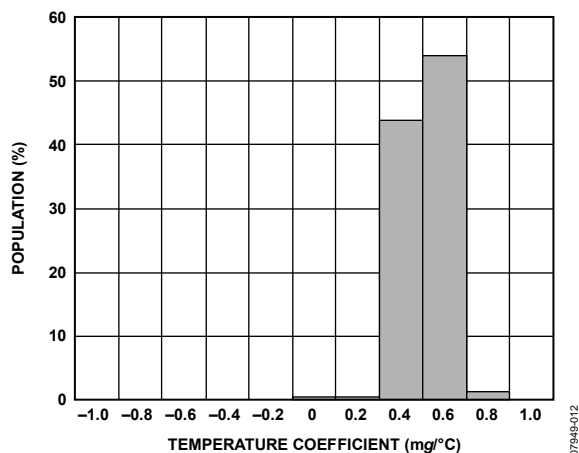

Figure 10. Y-Axis Zero g Bias Temperature Coefficient, $V_S = 3\text{ V}$

07949-012

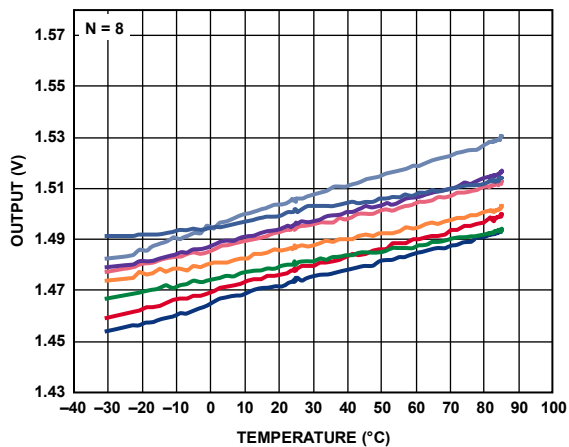

Figure 13. Y-Axis Zero g Bias vs. Temperature, Eight Parts Soldered to PCB

07949-015

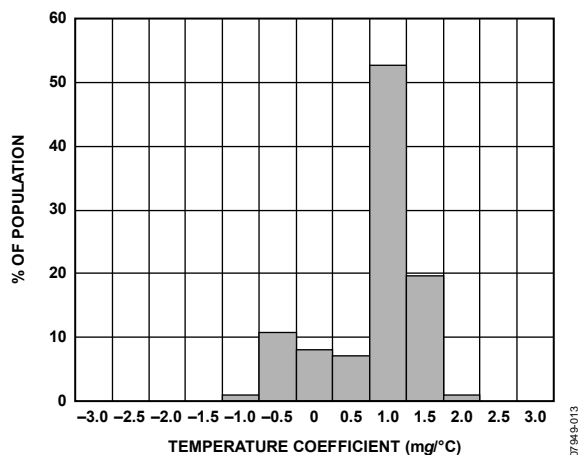

Figure 11. Z-Axis Zero g Bias Temperature Coefficient, $V_S = 3\text{ V}$

07949-013

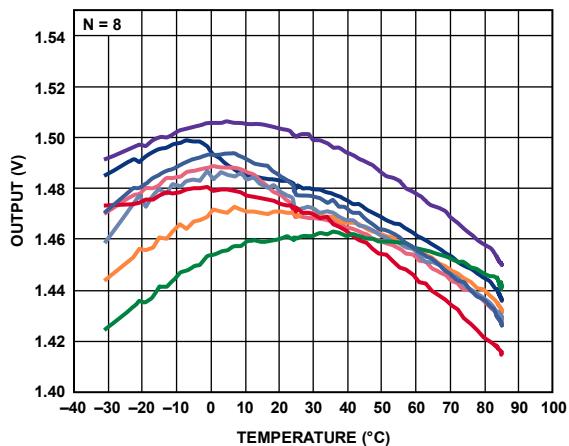

Figure 14. Z-Axis Zero g Bias vs. Temperature, Eight Parts Soldered to PCB

07949-016

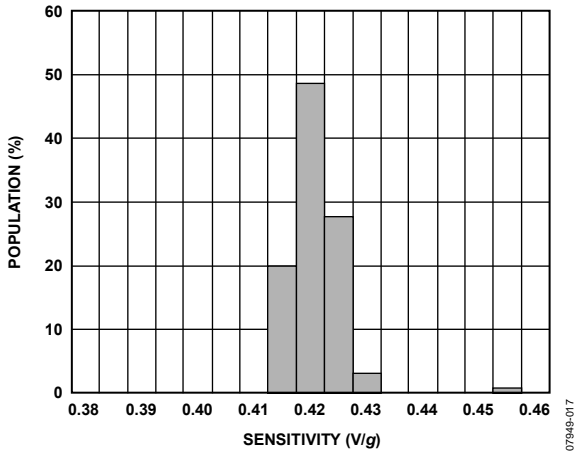

Figure 15. X-Axis Sensitivity at 25°C, V_S = 3 V

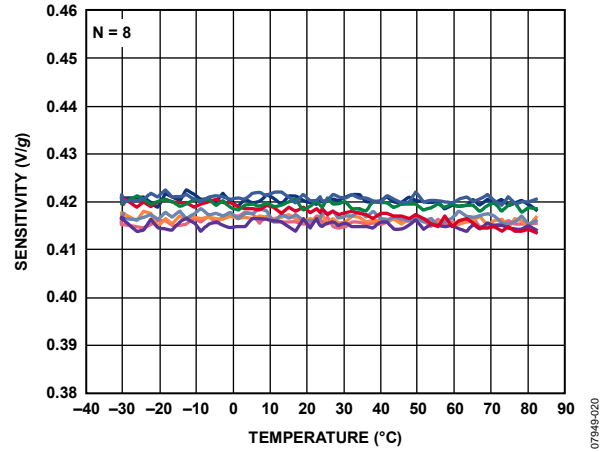

Figure 18. X-Axis Sensitivity vs. Temperature, Eight Parts Soldered to PCB, V_S = 3 V

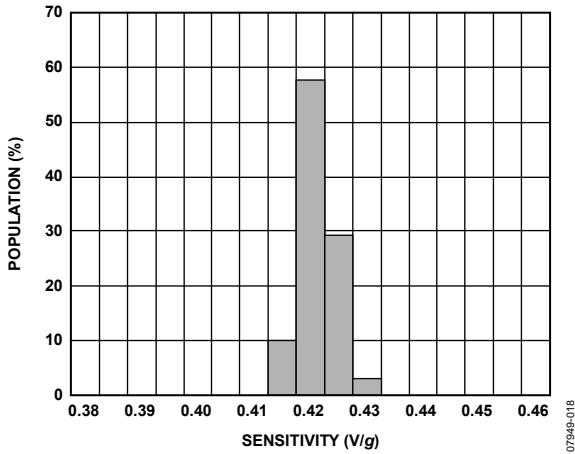

Figure 16. Y-Axis Sensitivity at 25°C, V_S = 3 V

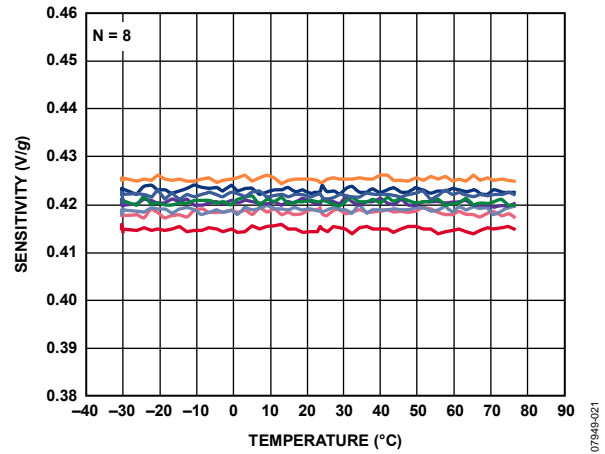

Figure 19. Y-Axis Sensitivity vs. Temperature, Eight Parts Soldered to PCB, V_S = 3 V

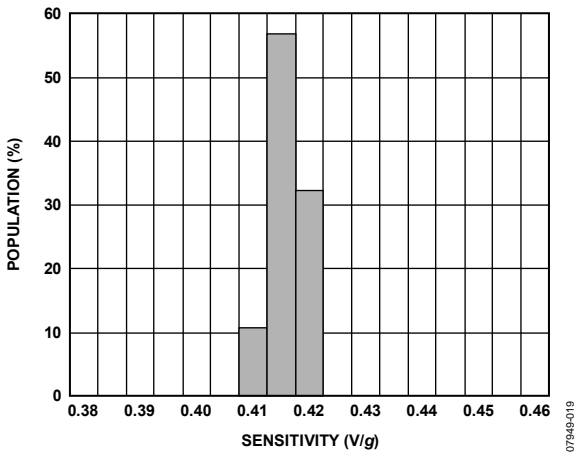

Figure 17. Z-Axis Sensitivity at 25°C, V_S = 3 V

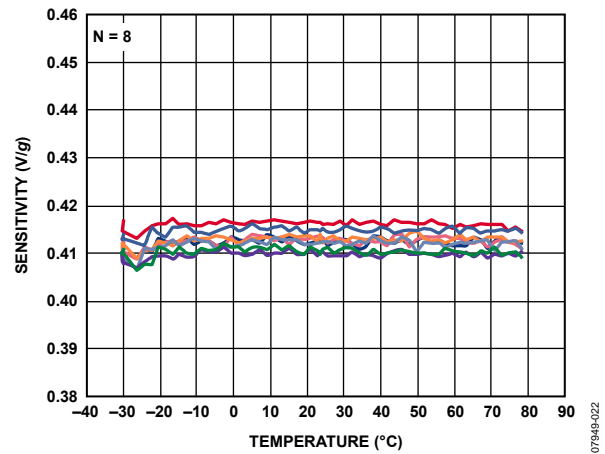

Figure 20. Z-Axis Sensitivity vs. Temperature, Eight Parts Soldered to PCB, V_S = 3 V

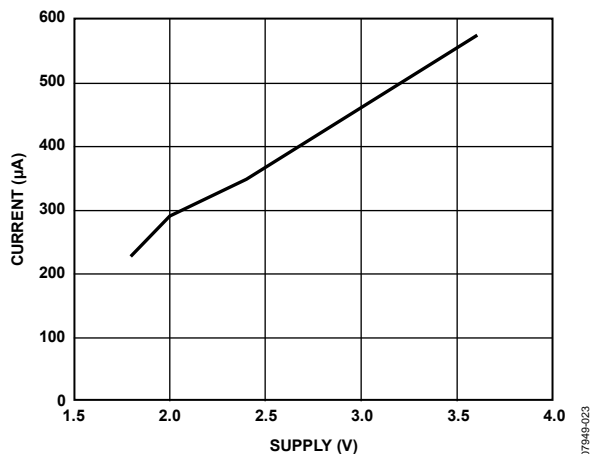

Figure 21. Typical Current Consumption vs. Supply Voltage

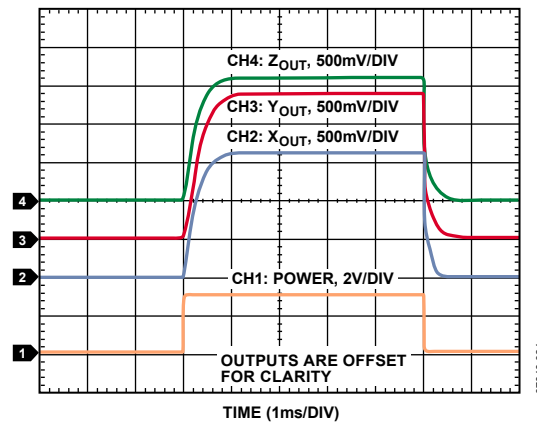

Figure 22. Typical Turn-On Time, $V_s = 3\text{ V}$
 $C_x = C_y = C_z = 0.0047\ \mu\text{F}$

THEORY OF OPERATION

The ADXL327 is a complete 3-axis acceleration measurement system. The ADXL327 has a measurement range of ± 2 g minimum. It contains a polysilicon surface micromachined sensor and signal conditioning circuitry to implement an open-loop acceleration measurement architecture. The output signals are analog voltages that are proportional to acceleration. The accelerometer can measure the static acceleration of gravity in tilt sensing applications, as well as dynamic acceleration, resulting from motion, shock, or vibration.

The sensor is a polysilicon surface micromachined structure built on top of a silicon wafer. Polysilicon springs suspend the structure over the surface of the wafer and provide a resistance against acceleration forces. Deflection of the structure is measured using a differential capacitor that consists of independent fixed plates and plates attached to the moving mass. The fixed plates are driven by 180° out-of-phase square waves. Acceleration deflects the moving mass and unbalances the differential capacitor resulting in a sensor output whose amplitude is proportional to acceleration. Phase-sensitive demodulation techniques are then used to determine the magnitude and direction of the acceleration.

The demodulator output is amplified and brought off-chip through a 32 k Ω resistor. The user then sets the signal bandwidth of the device by adding a capacitor. This filtering improves measurement resolution and helps prevent aliasing.

MECHANICAL SENSOR

The ADXL327 uses a single structure for sensing the X, Y, and Z axes. As a result, the three axes sense directions are highly orthogonal with little cross-axis sensitivity. Mechanical misalignment of the sensor die to the package is the chief source of cross-axis sensitivity. Mechanical misalignment can, of course, be calibrated out at the system level.

PERFORMANCE

Rather than using additional temperature compensation circuitry, innovative design techniques ensure that high performance is built-in to the ADXL327. As a result, there is neither quantization error nor nonmonotonic behavior, and temperature hysteresis is very low (typically <3 mg over the -25°C to $+70^{\circ}\text{C}$ temperature range).

APPLICATIONS INFORMATION

POWER SUPPLY DECOUPLING

For most applications, a single 0.1 μF capacitor, C_{DC} , placed close to the ADXL327 supply pins adequately decouples the accelerometer from noise on the power supply. However, in applications where noise is present at the 50 kHz internal clock frequency (or any harmonic thereof), additional care in power supply bypassing is required because this noise can cause errors in acceleration measurement. If additional decoupling is needed, a 100 Ω (or smaller) resistor or ferrite bead can be inserted in the supply line. Additionally, a larger bulk bypass capacitor (1 μF or greater) can be added in parallel to C_{DC} . Ensure that the connection from the ADXL327 ground to the power supply ground is low impedance because noise transmitted through ground has a similar effect as noise transmitted through V_{S} .

SETTING THE BANDWIDTH USING C_{X} , C_{Y} , AND C_{Z}

The ADXL327 has provisions for band limiting the X_{OUT} , Y_{OUT} , and Z_{OUT} pins. Capacitors must be added at these pins to implement low-pass filtering for antialiasing and noise reduction. The 3 dB bandwidth equation is

$$f_{-3 \text{ dB}} = 1/(2\pi(32 \text{ k}\Omega) \times C_{(X, Y, Z)})$$

or more simply

$$f_{-3 \text{ dB}} = 5 \mu\text{F}/C_{(X, Y, Z)}$$

The tolerance of the internal resistor (R_{FILT}) typically varies as much as $\pm 15\%$ of its nominal value (32 k Ω), and the bandwidth varies accordingly. A minimum capacitance of 0.0047 μF for C_{X} , C_{Y} , and C_{Z} is recommended in all cases.

Table 4. Filter Capacitor Selection, C_{X} , C_{Y} , and C_{Z}

| Bandwidth (Hz) | Capacitor (μF) |
|----------------|-----------------------------|
| 1 | 4.7 |
| 10 | 0.47 |
| 50 | 0.10 |
| 100 | 0.05 |
| 200 | 0.027 |
| 500 | 0.01 |

SELF TEST

The ST pin controls the self test feature. When this pin is set to V_{S} , an electrostatic force is exerted on the accelerometer beam. The resulting movement of the beam allows the user to test whether the accelerometer is functional. The typical change in output is -1.08 g (corresponding to -450 mV) in the X axis, $+1.08 \text{ g}$ ($+450 \text{ mV}$) on the Y axis, and $+1.83 \text{ g}$ ($+770 \text{ mV}$) on the Z axis. This ST pin can be left open circuit or connected to common (COM) in normal use.

Never expose the ST pin to voltages greater than $V_{\text{S}} + 0.3 \text{ V}$. If this cannot be guaranteed due to the system design (for instance, there are multiple supply voltages), then a low V_{F} clamping diode between ST and V_{S} is recommended.

DESIGN TRADE-OFFS FOR SELECTING FILTER CHARACTERISTICS: THE NOISE/BW TRADE-OFF

The selected accelerometer bandwidth ultimately determines the measurement resolution (smallest detectable acceleration). Filtering can be used to lower the noise floor to improve the resolution of the accelerometer. Resolution is dependent on the analog filter bandwidth at X_{OUT} , Y_{OUT} , and Z_{OUT} .

The output of the ADXL327 has a typical bandwidth greater than 500 Hz. The user must filter the signal at this point to limit aliasing errors. The analog bandwidth must be no more than half the analog-to-digital sampling frequency to minimize aliasing. The analog bandwidth can be further decreased to reduce noise and improve resolution.

The ADXL327 noise has the characteristics of white Gaussian noise, which contributes equally at all frequencies and is described in terms of $\mu\text{g}/\sqrt{\text{Hz}}$ (the noise is proportional to the square root of the accelerometer bandwidth). The user should limit bandwidth to the lowest frequency needed by the application to maximize the resolution and dynamic range of the accelerometer.

With the single-pole roll-off characteristic, the typical noise of the ADXL327 is determined by

$$\text{rms Noise} = \text{Noise Density} \times (\sqrt{\text{BW} \times 1.6})$$

Often, the peak value of the noise is desired. Peak-to-peak noise can only be estimated by statistical methods. Table 5 is useful for estimating the probabilities of exceeding various peak values, given the rms value.

Table 5. Estimation of Peak-to-Peak Noise

| Peak-to-Peak Value | % of Time That Noise Exceeds Nominal Peak-to-Peak Value |
|-----------------------|---|
| $2 \times \text{rms}$ | 32 |
| $4 \times \text{rms}$ | 4.6 |
| $6 \times \text{rms}$ | 0.27 |
| $8 \times \text{rms}$ | 0.006 |

USE WITH OPERATING VOLTAGES OTHER THAN 3 V

The ADXL327 is tested and specified at $V_{\text{S}} = 3 \text{ V}$; however, it can be powered with V_{S} as low as 1.8 V or as high as 3.6 V. Note that some performance parameters change as the supply voltage is varied.

The ADXL327 output is ratiometric; therefore, the output sensitivity (or scale factor) varies proportionally to the supply voltage. At $V_{\text{S}} = 3.6 \text{ V}$, the output sensitivity is typically 500 mV/g. At $V_{\text{S}} = 2 \text{ V}$, the output sensitivity is typically 289 mV/g.

The zero g bias output is also ratiometric; therefore, the zero g output is nominally equal to $V_{\text{S}}/2$ at all supply voltages.

The output noise is not ratiometric but is absolute in volts; therefore, the noise density decreases as the supply voltage increases. This is because the scale factor (mV/g) increases while the noise voltage remains constant. At $V_{\text{S}} = 3.6 \text{ V}$, the X- and Y-axis noise density is typically 200 $\mu\text{g}/\sqrt{\text{Hz}}$, while at $V_{\text{S}} = 2 \text{ V}$, the X- and Y-axis noise density is typically 300 $\mu\text{g}/\sqrt{\text{Hz}}$.

ADXL327

Self test response in g is roughly proportional to the square of the supply voltage. However, when ratiometricity of sensitivity is factored in with supply voltage, the self test response in volts is roughly proportional to the cube of the supply voltage.

For example, at $V_s = 3.6\text{ V}$, the self test response for the ADXL327 is approximately -780 mV for the X axis, $+780\text{ mV}$ for the Y axis, and $+1330\text{ mV}$ for the Z axis. At $V_s = 2\text{ V}$, the self test response is approximately -130 mV for the X axis, $+130\text{ mV}$ for the Y axis, and -220 mV for the Z axis.

The supply current decreases as the supply voltage decreases. Typical current consumption at $V_s = 3.6\text{ V}$ is $375\text{ }\mu\text{A}$, and typical current consumption at $V_s = 2\text{ V}$ is $300\text{ }\mu\text{A}$.

AXES OF ACCELERATION SENSITIVITY

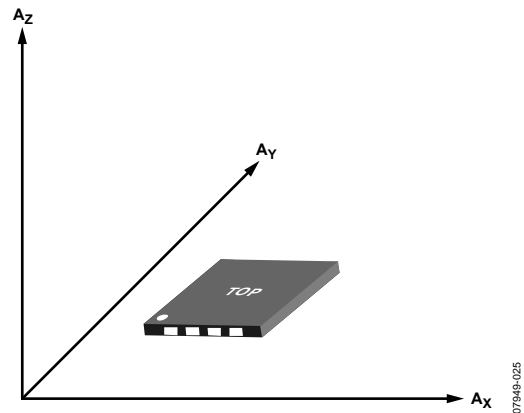

Figure 23. Axes of Acceleration Sensitivity (Corresponding Output Voltage Increases When Accelerated Along the Sensitive Axis)

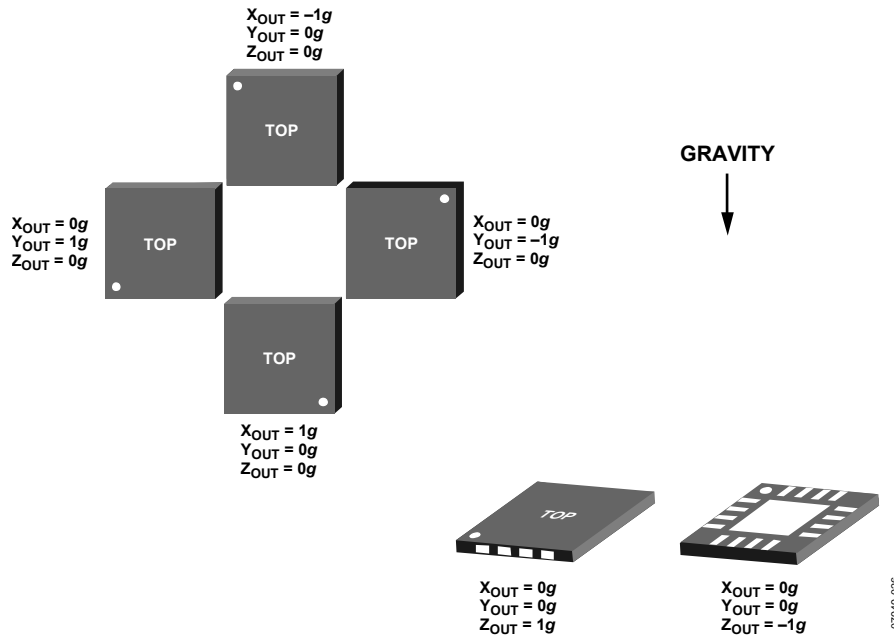

Figure 24. Output Response vs. Orientation to Gravity

LAYOUT AND DESIGN RECOMMENDATIONS

The recommended soldering profile is shown in Figure 25, followed by a description of the profile features in Table 6. The recommended PCB layout or solder land drawing is shown in Figure 26.

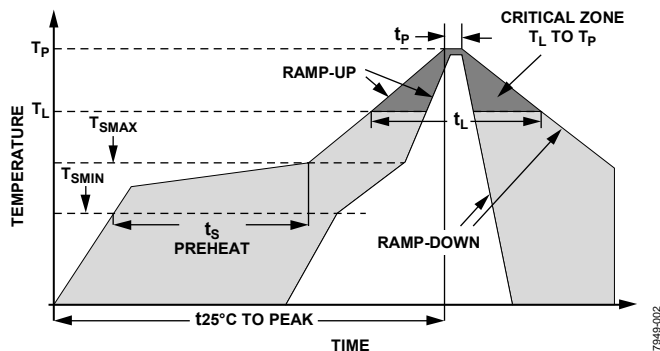

Figure 25. Recommended Soldering Profile

Table 6. Recommended Soldering Profile

| Profile Feature | Sn63/Pb37 | Pb-Free |
|--|-------------------|-------------------|
| Average Ramp Rate (T_L to T_P) | 3°C/sec maximum | 3°C/sec maximum |
| Preheat | | |
| Minimum Temperature (T_{SMIN}) | 100°C | 150°C |
| Maximum Temperature (T_{SMAX}) | 150°C | 200°C |
| Time (T_{SMIN} to T_{SMAX}), t_s | 60 sec to 120 sec | 60 sec to 180 sec |
| T_{SMAX} to T_L | | |
| Ramp-Up Rate | 3°C/sec maximum | 3°C/sec maximum |
| Time Maintained Above Liquidous (T_L) | | |
| Liquidous Temperature (T_L) | 183°C | 217°C |
| Time (t_L) | 60 sec to 150 sec | 60 sec to 150 sec |
| Peak Temperature (T_P) | 240°C + 0°C/-5°C | 260°C + 0°C/-5°C |
| Time Within 5°C of Actual Peak Temperature (t_p) | 10 sec to 30 sec | 20 sec to 40 sec |
| Ramp-Down Rate | 6°C/sec maximum | 6°C/sec maximum |
| Time 25°C to Peak Temperature | 6 minutes maximum | 8 minutes maximum |

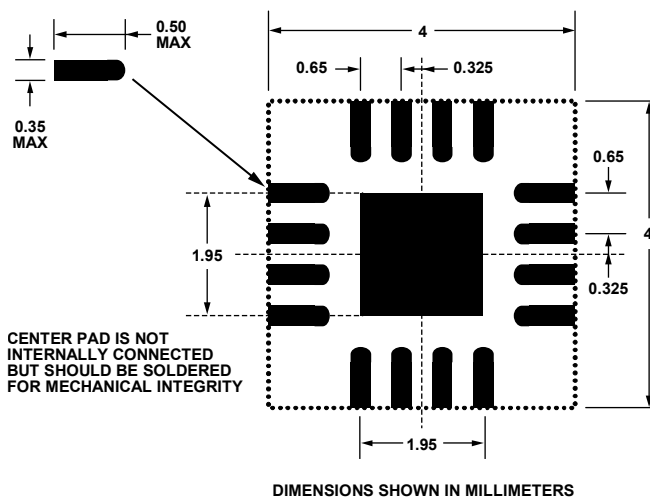
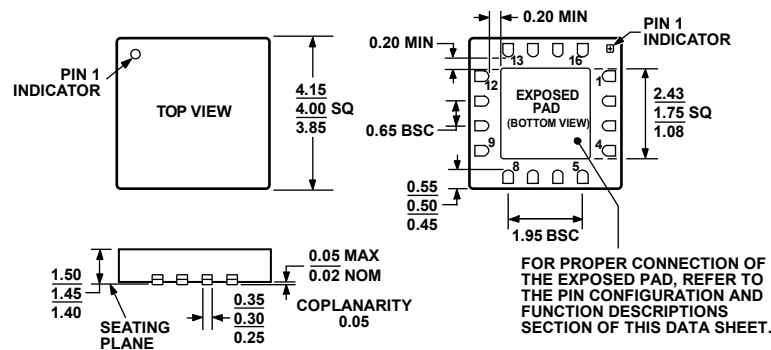

Figure 26. Recommended PCB Layout

OUTLINE DIMENSIONS



*STACKED DIE WITH GLASS SEAL.

Figure 27. 16-Lead Lead Frame Chip Scale Package [LFCSP_LQ]
 4 mm × 4 mm Body, 1.45 mm Thick Quad
 (CP-16-5a*)
 Dimensions shown in millimeters

112008-A

ORDERING GUIDE

| Model | Measurement Range | Specified Voltage | Temperature Range | Package Description | Package Option |
|------------------------------|-------------------|-------------------|-------------------|---------------------|----------------|
| ADXL327BCPZ ¹ | ±2 g | 3 V | -40°C to +85°C | 16-Lead LFCSP_LQ | CP-16-5a |
| ADXL327BCPZ-RL ¹ | ±2 g | 3 V | -40°C to +85°C | 16-Lead LFCSP_LQ | CP-16-5a |
| ADXL327BCPZ-RL7 ¹ | ±2 g | 3 V | -40°C to +85°C | 16-Lead LFCSP_LQ | CP-16-5a |
| EVAL-ADXL327Z ¹ | | | | Evaluation Board | |

¹ Z = RoHS Compliant Part.

NOTES