

Low Noise, Low Drift, Low Power, 3-Axis MEMS Accelerometer

**FEATURES**

- ▶ 0 g offset vs. temperature (all axes):  $\pm 0.2 \text{ mg}/^\circ\text{C}$  typical
- ▶ Ultralow noise spectral density (all axes):  $80 \text{ }\mu\text{g}/\sqrt{\text{Hz}}$
- ▶ Low power,  $V_{\text{SUPPLY}}$  (LDO regulator enabled)
  - ▶ In measurement mode:  $150 \text{ }\mu\text{A}$
  - ▶ In standby mode:  $21 \text{ }\mu\text{A}$
- ▶ User adjustable analog output bandwidth
- ▶ Integrated temperature sensor
- ▶ Voltage range options
  - ▶  $V_{\text{SUPPLY}}$  with internal regulators: 2.25 V to 3.6 V
  - ▶  $V_{1P8ANA}$ ,  $V_{1P8DIG}$  with internal LDO regulator bypassed: 1.8 V typical  $\pm 10\%$
- ▶ Operating temperature range:  $-40^\circ\text{C}$  to  $+125^\circ\text{C}$
- ▶ 14-terminal,  $4 \text{ mm} \times 4 \text{ mm} \times 1.04 \text{ mm}$ , LGA package

**APPLICATIONS**

- ▶ Inertial measurement units (IMUs)/attitude and heading reference systems (AHRs)
- ▶ Platform stabilization systems
- ▶ Structural health monitoring
- ▶ Seismic imaging
- ▶ Tilt sensing
- ▶ Robotics
- ▶ Condition monitoring

**GENERAL DESCRIPTION**

The analog output ADXL358<sup>1</sup> is a low noise density, low 0 g offset drift, low power, 3-axis accelerometer with selectable measurement ranges. The ADXL358B supports the  $\pm 10 \text{ g}$  and  $\pm 20 \text{ g}$  ranges, and the ADXL358C supports the  $\pm 10 \text{ g}$  and  $\pm 40 \text{ g}$  ranges.

The ADXL358 offers industry leading noise, minimal offset drift over temperature, and long-term stability, enabling precision applications with minimal calibration.

The low noise of the ADXL358 over higher frequencies is ideal for condition-based monitoring and other vibration sensing applications.

**FUNCTIONAL BLOCK DIAGRAM**

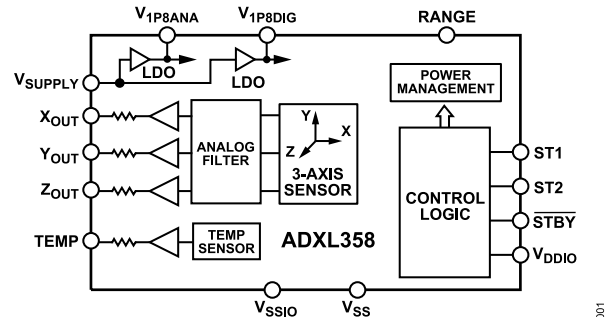

Figure 1. Functional Block Diagram

<sup>1</sup> Protected by U.S. Patents 8,472,270; 9,041,462; 8,665,627; 8,917,099; 6,892,576; 9,297,825; and 7,956,621.

**TABLE OF CONTENTS**

Features.....	1	Power Supply Description.....	13
Applications.....	1	V <sub>SUPPLY</sub> .....	13
General Description.....	1	V <sub>1P8ANA</sub> .....	13
Functional Block Diagram.....	1	V <sub>1P8DIG</sub> .....	13
Specifications.....	3	V <sub>DDIO</sub> .....	13
Absolute Maximum Ratings.....	5	Overrange Protection.....	13
Thermal Resistance.....	5	Self Test.....	13
ESD Caution.....	5	Filter.....	13
Pin Configuration and Function Descriptions.....	6	Recommended Soldering Profile.....	14
Typical Performance Characteristics.....	7	PCB Footprint Pattern.....	15
Theory of Operation.....	11	Outline Dimensions.....	16
Applications Information.....	12	Ordering Guide.....	16
Axes of Acceleration Sensitivity.....	12	Evaluation Boards.....	16
Power Sequencing.....	12		

**REVISION HISTORY****5/2023—Revision 0: Initial Version**

## SPECIFICATIONS

$T_A = 25^\circ\text{C}$ ,  $V_{\text{SUPPLY}} = 3.3\text{ V}$ , x-axis acceleration and y-axis acceleration = 0 g, z-axis acceleration = 1 g, and full-scale range =  $\pm 10\text{ g}$ , unless otherwise noted.

Table 1. Specifications

Parameter	Test Conditions/Comments	Min	Typ	Max	Unit
<b>SENSOR INPUT</b>					
Output Full-Scale Range (FSR)	Each axis ADXL358B supports two ranges ADXL358C supports two ranges		$\pm 10, \pm 20$ $\pm 10, \pm 40$		g g
Nonlinearity	$\pm 10\text{ g}$ $\pm 40\text{ g}$		0.1 1.3		% FSR % FSR
Cross Axis Sensitivity			1		%
<b>SENSITIVITY</b>					
Sensitivity at $X_{\text{OUT}}$ , $Y_{\text{OUT}}$ , and $Z_{\text{OUT}}$	Ratiometric to $V_{1\text{P8ANA}}$ $\pm 10\text{ g}$ $\pm 20\text{ g}$ $\pm 40\text{ g}$		80 40 20		mV/g mV/g mV/g
Sensitivity Change due to Temperature	$T_A = -40^\circ\text{C}$ to $+125^\circ\text{C}$		$\pm 0.02$		%/°C
<b>0 g OFFSET</b>					
0 g Output for $X_{\text{OUT}}$ , $Y_{\text{OUT}}$ , and $Z_{\text{OUT}}$	Each axis, $\pm 10\text{ g}$ Referred to $V_{1\text{P8ANA}}/2$		$\pm 125$		mg
0 g Offset vs. Temperature (X-Axis, Y-Axis, and Z-Axis) <sup>1</sup>	$T_A = -40^\circ\text{C}$ to $+125^\circ\text{C}$		$\pm 0.2$		mg/°C
Vibration Rectification Error (VRE) <sup>2</sup>	Offset due to 7.5 g RMS vibration, $\pm 10\text{ g}$ range, in a 1 g orientation		<0.1		g
<b>NOISE</b>					
Spectral Density <sup>3</sup> X-Axis, Y-Axis, and Z-Axis	$\pm 10\text{ g}$ $\pm 40\text{ g}$		80 110		$\mu\text{g}/\sqrt{\text{Hz}}$ $\mu\text{g}/\sqrt{\text{Hz}}$
<b>BANDWIDTH</b>	-3 dB, overall transfer function <sup>4</sup>		2.4		kHz
<b>SELF TEST</b>					
Output Change X-Axis Y-Axis Z-Axis	$\pm 10\text{ g}$ range <sup>5</sup>	0.05 0.05 1.0	0.2 0.28 1.7	0.40 0.40 2.20	g g g
<b>POWER SUPPLY</b>					
Voltage Range $V_{\text{SUPPLY}}$ <sup>6</sup> $V_{\text{DDIO}}$ $V_{1\text{P8ANA}}$ , $V_{1\text{P8DIG}}$	Internal low dropout (LDO) regulator bypassed, $V_{\text{SUPPLY}} = 0\text{ V}$	2.25 $V_{1\text{P8DIG}}$ 1.62	2.5 2.5 1.8	3.6 3.6 1.98	V V V
<b>Current</b>					
<b>Measurement Mode</b>					
$V_{\text{SUPPLY}}$	LDO regulator enabled		150		$\mu\text{A}$
$V_{1\text{P8ANA}}$	LDO regulator disabled		138		$\mu\text{A}$
$V_{1\text{P8DIG}}$	LDO regulator disabled		10.5		$\mu\text{A}$
<b>Standby Mode</b>					
$V_{\text{SUPPLY}}$	LDO regulator enabled		21		$\mu\text{A}$
$V_{1\text{P8ANA}}$	LDO regulator disabled		7		$\mu\text{A}$
$V_{1\text{P8DIG}}$	LDO regulator disabled		9		$\mu\text{A}$
Turn On Time <sup>7</sup>	10 g range Power off to standby		<10 <10		ms ms

## SPECIFICATIONS

Table 1. Specifications (Continued)

Parameter	Test Conditions/Comments	Min	Typ	Max	Unit
OUTPUT AMPLIFIER	$X_{OUT}$ , $Y_{OUT}$ , $Z_{OUT}$ , and TEMP pins				
Swing	No load	0.03		$V_{1P8ANA} - 0.03$	V
Output Series Resistance			32		k $\Omega$
TEMPERATURE SENSOR					
Output at 25°C			967		mV
Scale Factor			3.0		mV/°C
TEMPERATURE					
Operating Temperature Range		-40		+125	°C

<sup>1</sup> The temperature change is -40°C to +25°C or +25°C to +125°C.

<sup>2</sup> The VRE measurement is the shift in DC offset while the device is subject to 7.5 g RMS of random vibration from 50 Hz to 2 kHz. The device under test (DUT) is configured for the  $\pm 10$  g range and an output data rate of 4 kHz. The VRE scales with the range setting.

<sup>3</sup> Based on characterization.

<sup>4</sup> The overall transfer function includes the sensor mechanical response and all other filters on the signal chain.

<sup>5</sup>  $\pm 10$  g indicates a test condition. The self test result converted to the acceleration value is independent of the selected range.

<sup>6</sup> When  $V_{1P8ANA}$  and  $V_{1P8DIG}$  are generated internally,  $V_{SUPPLY}$  is valid. To disable the LDO regulator and drive  $V_{1P8ANA}$  and  $V_{1P8DIG}$  externally, connect  $V_{SUPPLY}$  to  $V_{SS}$ .

<sup>7</sup> This time is the standby to measurement mode. This specification is valid when the output is within 5 mg of the final value.

## ABSOLUTE MAXIMUM RATINGS

**Table 2. Absolute Maximum Ratings**

Parameter	Rating
Acceleration (Any Axis, Half Sine Wave, 0.1 ms Pulse Width)	
Unpowered	10,000 g
Powered	10,000 g
Vibration	Per MIL-STD-883 Method 2007, Test Condition C
$V_{\text{SUPPLY}}$ and $V_{\text{DDIO}}$	5.4 V
$V_{\text{IP8ANA}}$ and $V_{\text{IP8DIG}}$ Configured as Inputs	1.98 V
Digital Inputs (RANGE, ST1, ST2, and $\overline{\text{STBY}}$ )	-0.3 V to $V_{\text{DDIO}} + 0.3$ V
Analog Outputs ( $X_{\text{OUT}}$ , $Y_{\text{OUT}}$ , $Z_{\text{OUT}}$ , and TEMP)	-0.3 V to $V_{\text{IP8ANA}} + 0.3$ V
Temperature Range	
Operating	-40°C to +125°C
Storage	-55°C to +150°C

Stresses at or above those listed under Absolute Maximum Ratings may cause permanent damage to the product. This is a stress rating only; functional operation of the product at these or any other conditions above those indicated in the operational section of this specification is not implied. Operation beyond the maximum operating conditions for extended periods may affect product reliability.

## THERMAL RESISTANCE

Thermal performance is directly linked to printed circuit board (PCB) design and operating environment. Careful attention to PCB thermal design is required.

$\theta_{\text{JA}}$  is the natural convection junction to ambient thermal resistance measured in a one cubic foot sealed enclosure, and  $\psi_{\text{JB}}$  is the junction to board thermal resistance.

**Table 3. Thermal Resistance**

Package Type <sup>1</sup>	$\theta_{\text{JA}}$	$\psi_{\text{JB}}$	Unit
CC-14-2	79.10	41.76	°C/W

<sup>1</sup> Thermal impedance simulated values are based on a JEDEC 2S2P thermal test board with four thermal vias. See JEDEC JESD-51.

## ESD CAUTION



**ESD (electrostatic discharge) sensitive device.** Charged devices and circuit boards can discharge without detection. Although this product features patented or proprietary protection circuitry, damage may occur on devices subjected to high energy ESD. Therefore, proper ESD precautions should be taken to avoid performance degradation or loss of functionality.

## PIN CONFIGURATION AND FUNCTION DESCRIPTIONS

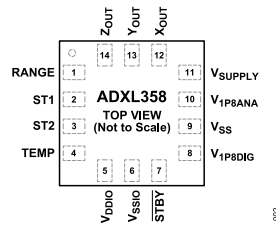

Figure 2. Pin Configuration

Table 4. Pin Function Descriptions

Pin No.	Mnemonic	Description
1	RANGE	Range Selection Pin. Set the RANGE pin to ground to select the $\pm 10$ g range or set the RANGE pin to $V_{DDIO}$ to select the $\pm 20$ g or $\pm 40$ g range. The RANGE pin is model dependent (see the <a href="#">Ordering Guide</a> section).
2	ST1	Self Test Pin 1. The ST1 pin enables self test mode. The ST1 pin must be forced low when not in self test mode.
3	ST2	Self Test Pin 2. The ST2 pin activates electromechanical self test actuation. The ST2 pin must be forced low when not in self test mode.
4	TEMP	Temperature Sensor Output.
5	$V_{DDIO}$	Digital Interface Supply Voltage.
6	$V_{SSIO}$	Digital Ground.
7	$\overline{STBY}$	Standby or Measurement Mode Selection Pin. Set the $\overline{STBY}$ pin to ground to enter standby mode, or set the $\overline{STBY}$ pin to $V_{DDIO}$ to enter measurement mode.
8	$V_{1P8DIG}$	Digital Supply. The $V_{1P8DIG}$ pin requires a decoupling capacitor. If $V_{SUPPLY}$ connects to $V_{SS}$ , supply the voltage to the $V_{1P8DIG}$ pin externally.
9	$V_{SS}$	Analog Ground.
10	$V_{1P8ANA}$	Analog Supply. The $V_{1P8ANA}$ pin requires a decoupling capacitor. If $V_{SUPPLY}$ connects to $V_{SS}$ , supply the voltage to the $V_{1P8ANA}$ pin externally.
11	$V_{SUPPLY}$	Supply Voltage. When $V_{SUPPLY}$ equals 2.25 V to 3.6 V, $V_{SUPPLY}$ enables the internal LDO regulator to generate $V_{1P8DIG}$ and $V_{1P8ANA}$ . For $V_{SUPPLY} = V_{SS}$ , $V_{1P8DIG}$ and $V_{1P8ANA}$ are externally supplied.
12	$X_{OUT}$	X-Axis Output.
13	$Y_{OUT}$	Y-Axis Output.
14	$Z_{OUT}$	Z-Axis Output.

TYPICAL PERFORMANCE CHARACTERISTICS

All figures include data for multiple devices and multiple lots, and the figures were taken in the  $\pm 10\text{ g}$  range and  $T_A = 25^\circ\text{C}$ , unless otherwise noted.

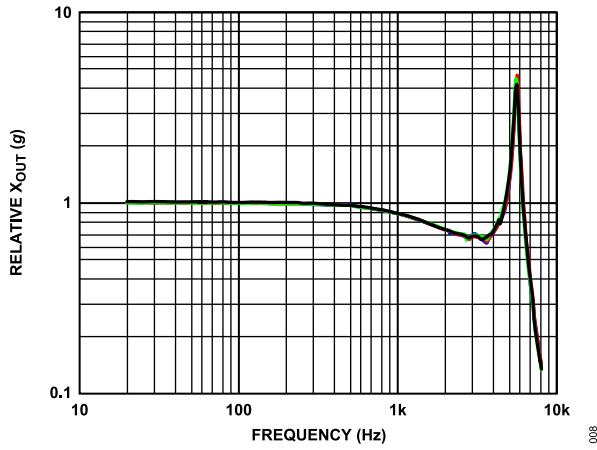

Figure 3. Frequency Response for X-Axis

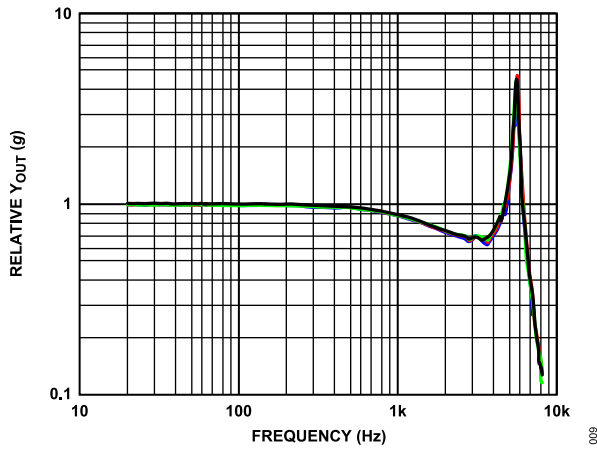

Figure 4. Frequency Response for Y-Axis

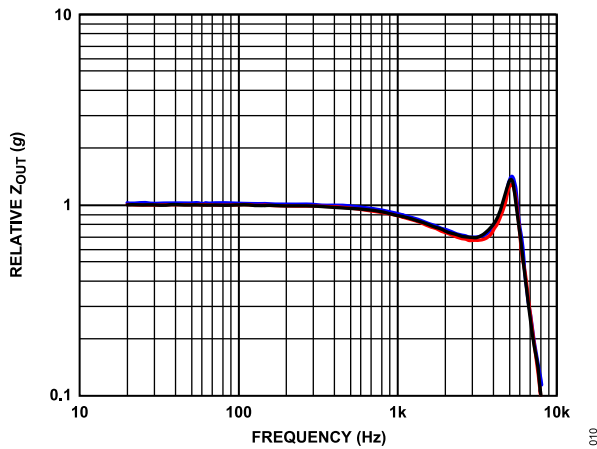

Figure 5. Frequency Response for Z-Axis

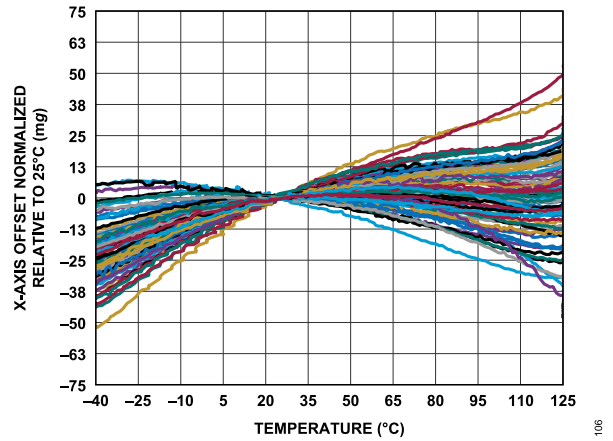

Figure 6. Zero g Offset Normalized Relative to 25°C vs. Temperature, X-Axis

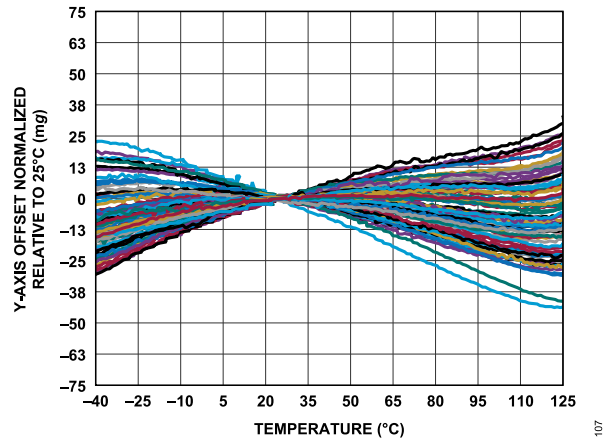

Figure 7. Zero g Offset Normalized Relative to 25°C vs. Temperature, Y-Axis

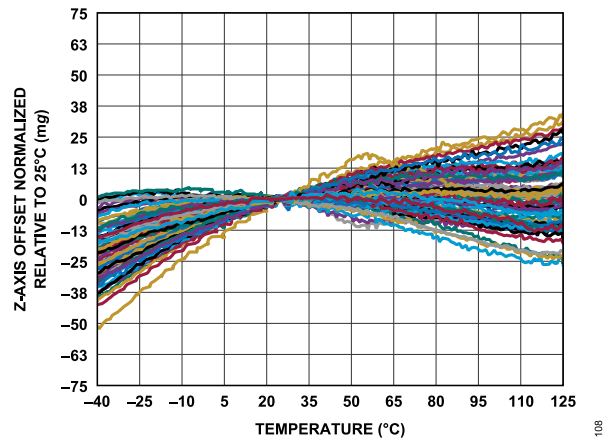

Figure 8. Zero g Offset Normalized Relative to 25°C vs. Temperature, Z-Axis

TYPICAL PERFORMANCE CHARACTERISTICS

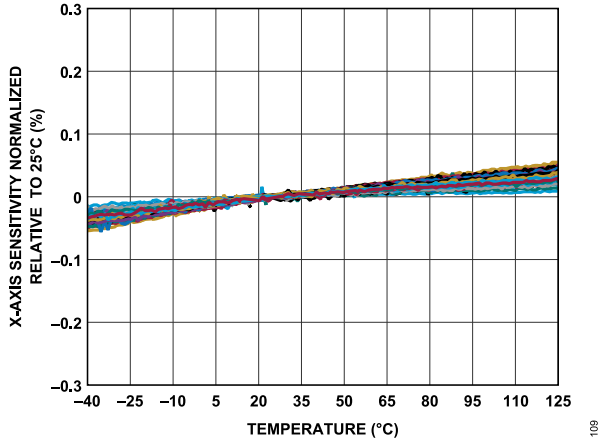

Figure 9. Sensitivity Normalized Relative to 25°C vs. Temperature, X-Axis

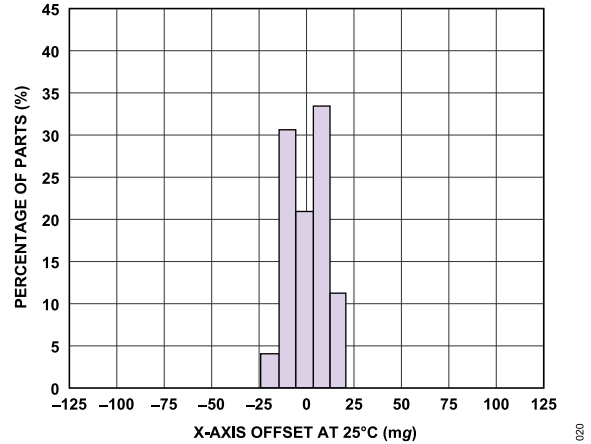

Figure 12. Zero g Offset Histogram at 25°C, X-Axis

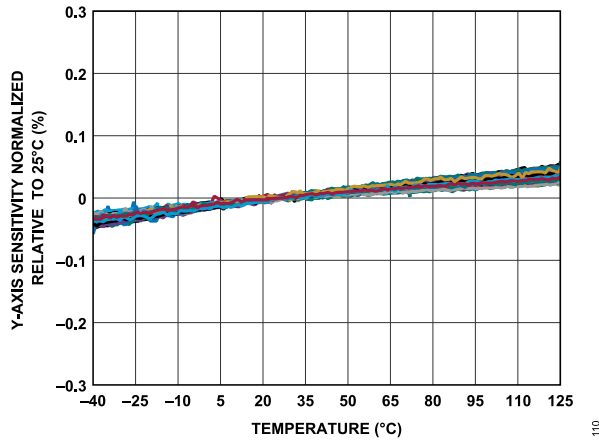

Figure 10. Sensitivity Normalized Relative to 25°C vs. Temperature, Y-Axis

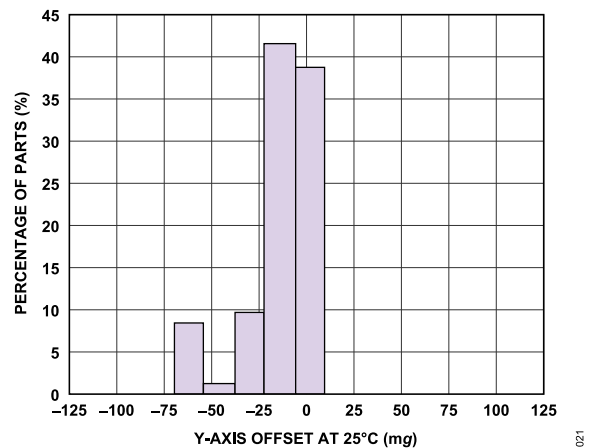

Figure 13. Zero g Offset Histogram at 25°C, Y-Axis

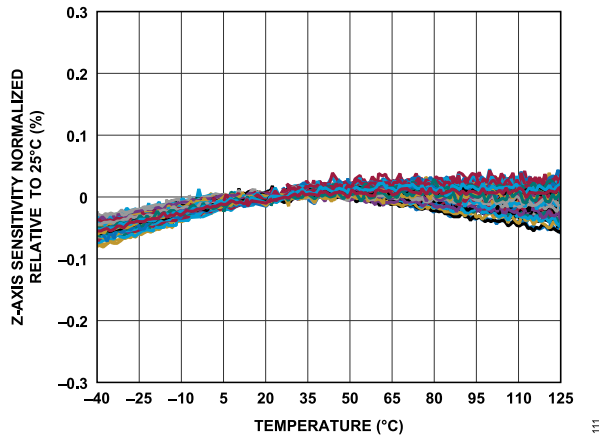

Figure 11. Sensitivity Normalized Relative to 25°C vs. Temperature, Z-Axis

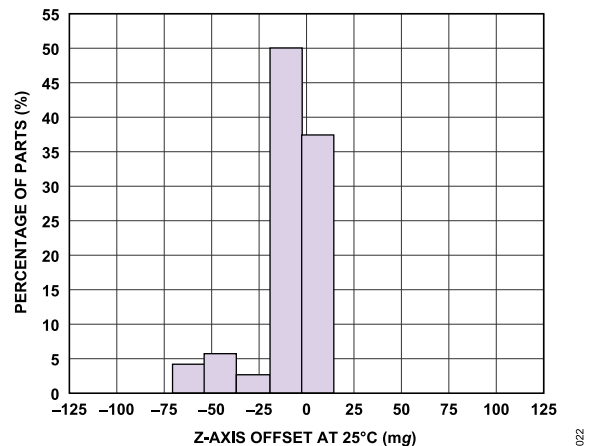

Figure 14. Zero g Offset Histogram at 25°C, Z-Axis



TYPICAL PERFORMANCE CHARACTERISTICS

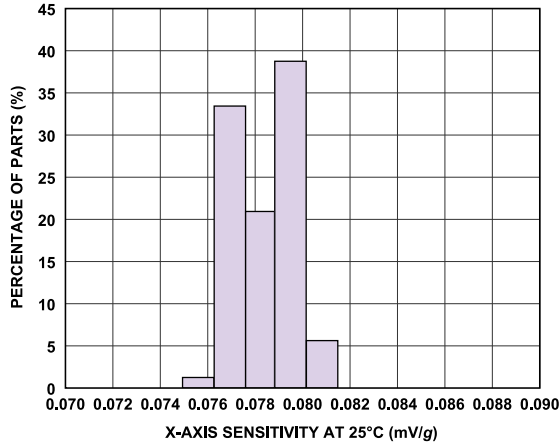

Figure 15. Sensitivity Histogram at 25°C, X-Axis

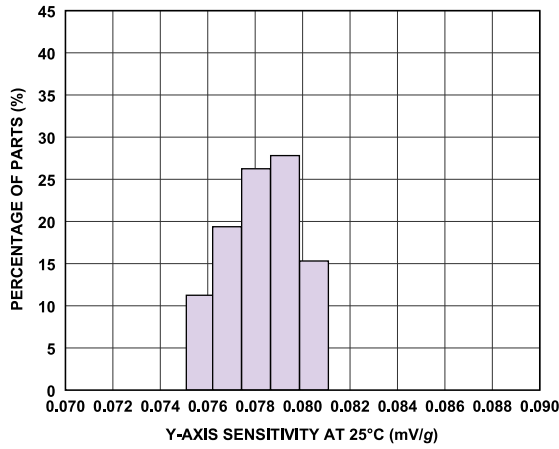

Figure 16. Sensitivity Histogram at 25°C, Y-Axis

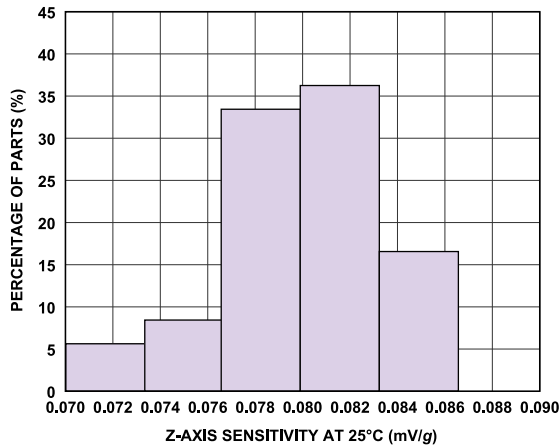

Figure 17. Sensitivity Histogram at 25°C, Z-Axis

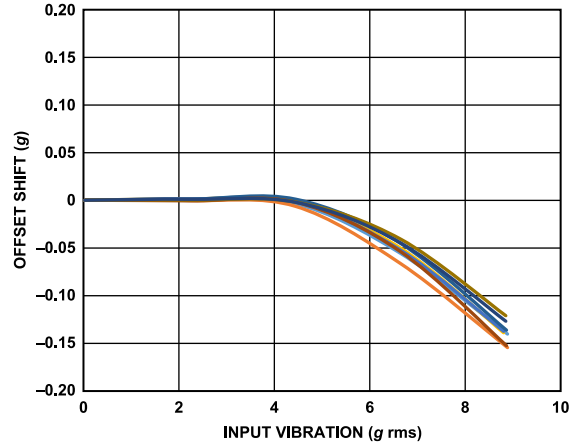

Figure 18. VRE, X-Axis Offset from +1 g, ±10 g Range, X-Axis Orientation = +1 g

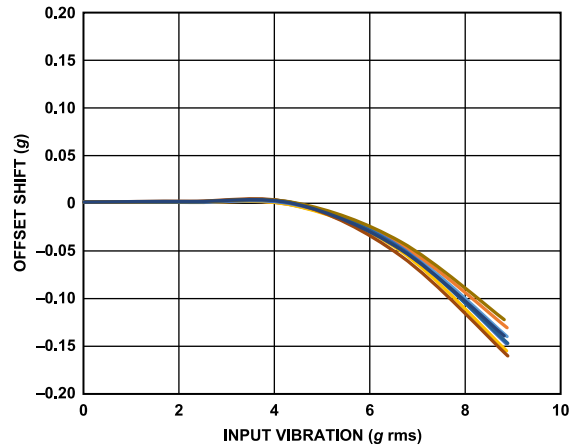

Figure 19. VRE, Y-Axis Offset from +1 g, ±10 g Range, Y-Axis Orientation = +1 g

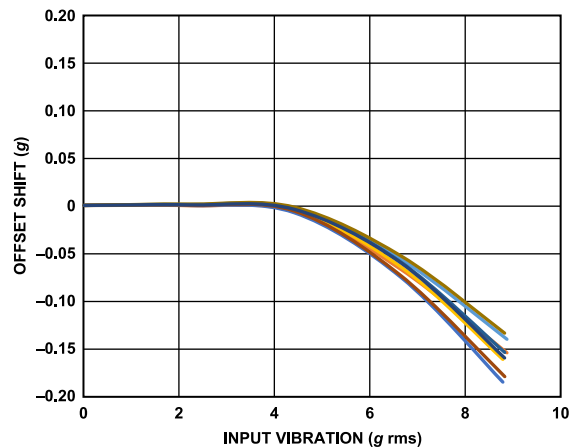

Figure 20. VRE, Z-Axis Offset from +1 g, ±10 g Range, Z-Axis Orientation = +1 g

TYPICAL PERFORMANCE CHARACTERISTICS

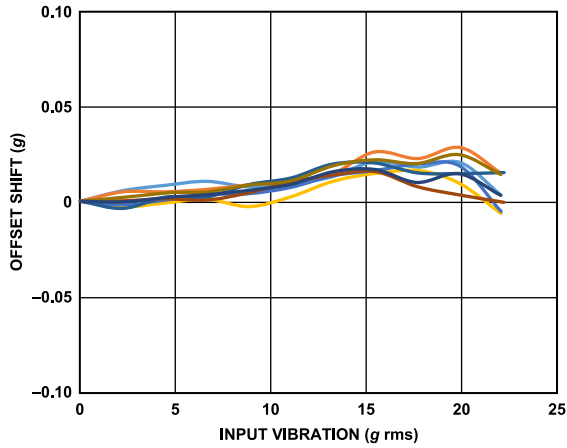

Figure 21. VRE, X-Axis Offset from -1 g, ±40 g Range, X-Axis Orientation = -1 g

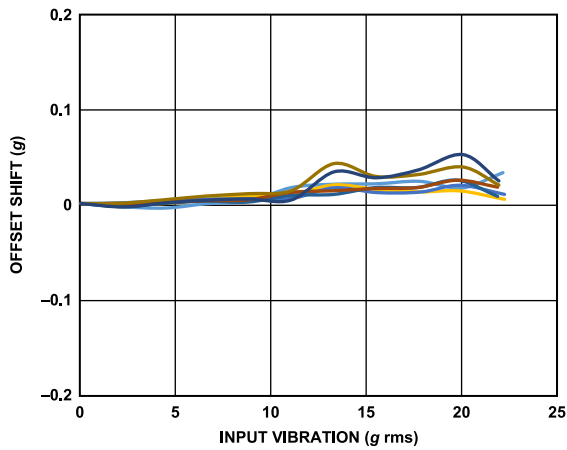

Figure 22. VRE, Y-Axis Offset from -1 g, ±40 g Range, Y-Axis Orientation = -1 g

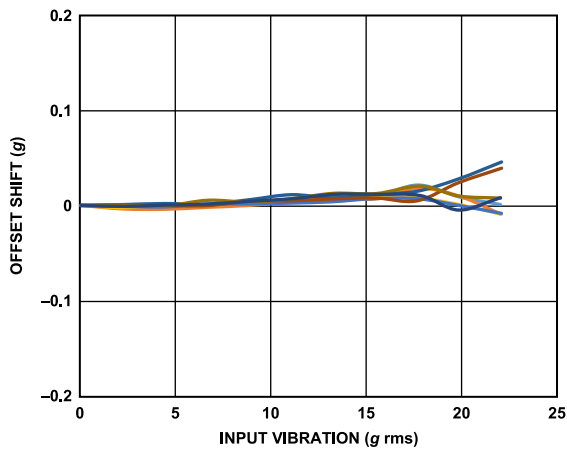

Figure 23. VRE, Z-Axis Offset from -1 g, ±40 g Range, Z-Axis Orientation = -1 g

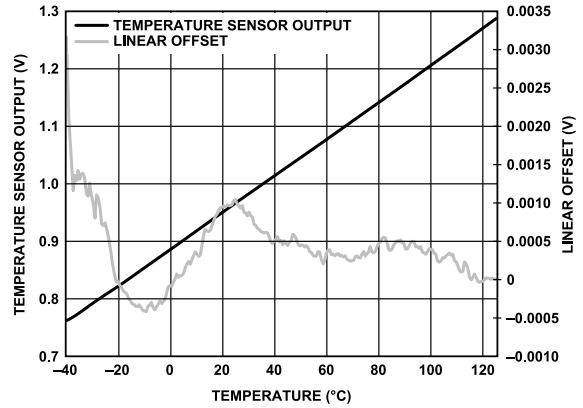

Figure 24. Temperature Sensor Output and Linear Offset vs. Temperature

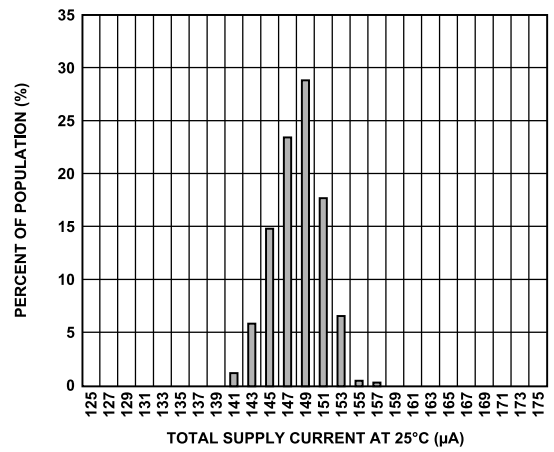

Figure 25. Total Supply Current at 25°C, 3.3 V

## THEORY OF OPERATION

The ADXL358 is a complete 3-axis, ultralow noise, and ultrastable offset microelectromechanical systems (MEMS) accelerometer with outputs ratiometric to the analog 1.8 V supply,  $V_{1P8ANA}$ . The ADXL358B is pin selectable for  $\pm 10 g$  or  $\pm 20 g$  full scale, and the ADXL358C is pin selectable for  $\pm 10 g$  or  $\pm 40 g$  full scale.

The micromachined, sensing elements are fully differential, comprising the lateral x-axis and y-axis sensors and the vertical, teeter totter z-axis sensors. The x-axis and y-axis sensors and the z-axis sensors go through separate signal paths that minimize offset drift and noise. The signal path is fully differential, except for a differential to single-ended conversion at the analog outputs of the ADXL358.

The analog accelerometer outputs of the ADXL358 are ratiometric to  $V_{1P8ANA}$ . Therefore, digitize these outputs carefully. The temperature sensor output is not ratiometric. The  $X_{OUT}$ ,  $Y_{OUT}$ , and  $Z_{OUT}$  analog outputs are filtered internally with an antialiasing filter. These analog outputs also have an internal 32 k $\Omega$  series resistor that can be used with an external capacitor to set the bandwidth of the output.

## APPLICATIONS INFORMATION

Figure 26 shows the ADXL358 application circuit. The analog outputs ( $X_{OUT}$ ,  $Y_{OUT}$ , and  $Z_{OUT}$ ) are ratiometric to the 1.8 V analog voltage from the  $V_{1P8ANA}$  pin.  $V_{1P8ANA}$  can be powered with an on-chip LDO regulator that is powered from  $V_{SUPPLY}$ .  $V_{1P8ANA}$  can also be supplied externally by forcing  $V_{SUPPLY}$  to  $V_{SS}$ , which disables the LDO regulator. Due to the ratiometric response, the analog output requires referencing to the  $V_{1P8ANA}$  supply when digitizing to achieve the inherent noise and offset performance of the ADXL358. The 0 g bias output is nominally equal to  $V_{1P8ANA}/2$ . The recommended option is to use the ADXL358 with a ratiometric analog-to-digital converter (ADC), for example, the Analog Devices, Inc., AD7682, and  $V_{1P8ANA}$  providing the voltage reference. This configuration results in self cancellation of errors due to minor supply variations.

FOR  $\pm 20g$ ,  $\pm 40g$ , CONNECT RANGE TO  $V_{DDIO}$ .  
FOR  $\pm 10g$ , CONNECT RANGE TO GND.

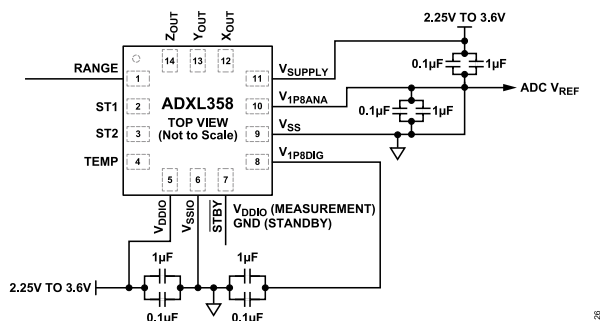

Figure 26. ADXL358 Application Circuit

The ADXL358 outputs two forms of filtering: internal antialiasing filtering with a cutoff frequency of approximately 1.5 kHz, and external filtering. The external filter uses a fixed, on-chip, 32 k $\Omega$  resistance in series with each output in conjunction with the external capacitors to implement the low-pass filter antialiasing and noise reduction prior to the external ADC. The antialias filter cutoff frequency must be significantly higher than the desired signal bandwidth. If the antialias filter corner is too low, ratiometricity can degrade where the signal attenuation is different from the reference attenuation.

## AXES OF ACCELERATION SENSITIVITY

Figure 27 shows the axes of acceleration sensitivity. Note that the output voltage increases when accelerated along the sensitive axis.

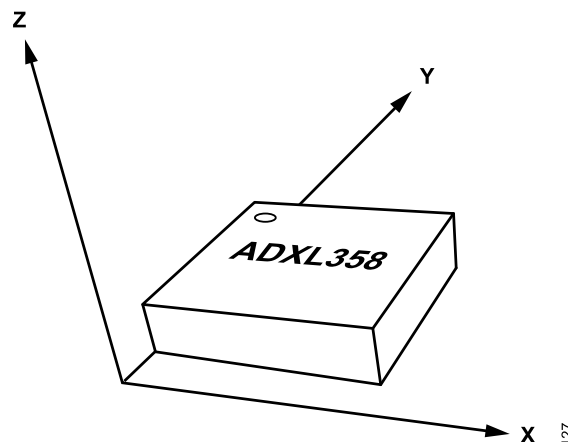

Figure 27. Axes of Acceleration Sensitivity

## POWER SEQUENCING

There are two methods for applying power to the device. Typically, internal LDO regulators generate the 1.8 V power for the analog and digital supplies,  $V_{1P8ANA}$  and  $V_{1P8DIG}$ , respectively. Optionally, the internal LDO regulators can be disabled, and  $V_{1P8ANA}$  and  $V_{1P8DIG}$  can be driven by external 1.8 V supplies.

When using the internal LDO regulators, connect  $V_{SUPPLY}$  to a voltage source between 2.25 V and 3.6 V. In this case, the recommended power sequence is to apply power to  $V_{DDIO}$ , followed by applying power to  $V_{SUPPLY}$  approximately 10  $\mu$ s after. If necessary,  $V_{SUPPLY}$  and  $V_{DDIO}$  can be powered from the same voltage source so that both are powered at the same time. However,  $V_{SUPPLY}$  cannot be powered before  $V_{DDIO}$ .

To disable the internal LDO regulators, tie  $V_{SUPPLY}$  to ground and use external 1.8 V supplies to power  $V_{1P8ANA}$  and  $V_{1P8DIG}$ .  $V_{1P8ANA}$  and  $V_{1P8DIG}$  must have the same voltage level. The maximum acceptable tolerance between the external  $V_{1P8ANA}$  and  $V_{1P8DIG}$  voltage levels is 50 mV. When bypassing the LDO regulators, the recommended power sequence is to apply power to  $V_{DDIO}$ , followed by applying power to  $V_{1P8DIG}$  approximately 10  $\mu$ s after, and then applying power to  $V_{1P8ANA}$  approximately 10  $\mu$ s after. If necessary,  $V_{1P8DIG}$  and  $V_{DDIO}$  can be powered from the same external 1.8 V supply, which can also be tied to  $V_{1P8ANA}$  with proper isolation so that all are powered at the same time. In this instance, proper decoupling and low frequency isolation are important to maintain the noise performance of the sensor.

## APPLICATIONS INFORMATION

### POWER SUPPLY DESCRIPTION

The ADXL358 has four different power supply domains:  $V_{\text{SUPPLY}}$ ,  $V_{\text{1P8ANA}}$ ,  $V_{\text{1P8DIG}}$ , and  $V_{\text{DDIO}}$ . The internal analog and digital circuitry operates at 1.8 V nominal.

#### $V_{\text{SUPPLY}}$

$V_{\text{SUPPLY}}$  is 2.25 V to 3.6 V, which is the input range to the two LDO regulators that generate the nominal 1.8 V outputs for  $V_{\text{1P8ANA}}$  and  $V_{\text{1P8DIG}}$ . Connect  $V_{\text{SUPPLY}}$  to  $V_{\text{SS}}$  to disable the LDO regulators, which allows driving  $V_{\text{1P8ANA}}$  and  $V_{\text{1P8DIG}}$  from an external source.

#### $V_{\text{1P8ANA}}$

All sensor and analog signal processing circuitry operates in this domain. Offset and sensitivity of the analog output ADXL358 are ratiometric to this supply voltage. When using external ADCs, use  $V_{\text{1P8ANA}}$  as the reference voltage.  $V_{\text{1P8ANA}}$  can be an input or an output as defined by the state of the  $V_{\text{SUPPLY}}$  voltage.

#### $V_{\text{1P8DIG}}$

$V_{\text{1P8DIG}}$  is the supply voltage for the internal logic circuitry. A separate LDO regulator decouples the digital supply noise from the analog signal path.  $V_{\text{1P8ANA}}$  can be an input or an output as defined by the state of the  $V_{\text{SUPPLY}}$  voltage. If driven externally,  $V_{\text{1P8DIG}}$  must be the same voltage as the  $V_{\text{1P8ANA}}$  voltage.

#### $V_{\text{DDIO}}$

The  $V_{\text{DDIO}}$  value determines the logic high levels for the self test pins, ST1 and ST2, as well as the STBY pin.

The LDO regulators are operational when  $V_{\text{SUPPLY}}$  is between 2.25 V and 3.6 V.  $V_{\text{1P8ANA}}$  and  $V_{\text{1P8DIG}}$  are the regulator outputs in this mode. Alternatively, when tying  $V_{\text{SUPPLY}}$  to  $V_{\text{SS}}$ ,  $V_{\text{1P8ANA}}$  and  $V_{\text{1P8DIG}}$  are supply voltage inputs with a 1.62 V to 1.98 V range.

### OVERRANGE PROTECTION

To avoid electrostatic capture of the proof mass when the accelerometer is subject to input acceleration beyond its full-scale range, all sensor drive clocks turn off for 0.5 ms. In the  $\pm 10 g$  range setting, the overrange protection activates for input signals beyond approximately  $\pm 40 g$  ( $\pm 25\%$ ), and for the  $\pm 20 g$  and  $\pm 40 g$  range settings, the threshold corresponds to about  $\pm 80 g$  ( $\pm 25\%$ ). When overrange protection occurs, the  $X_{\text{OUT}}$ ,  $Y_{\text{OUT}}$ , and  $Z_{\text{OUT}}$  pins on the ADXL358 begin to drive to midscale.

### SELF TEST

The ADXL358 incorporates a self test feature that effectively tests the mechanical and electronic system. Enabling self test stimulates the sensor electrostatically to produce an output corresponding to the test signal applied as well as the mechanical force exerted. Only the z-axis response is specified to validate device functionality.

In the ADXL358, drive the ST1 pin to  $V_{\text{DDIO}}$  to invoke self test mode. Then, by driving the ST2 pin to  $V_{\text{DDIO}}$ , the ADXL358 applies

an electrostatic force to the mechanical sensor and induces a change in output in response to the force. The self test delta (or response) is the difference in output voltage in the z-axis when ST2 is high vs. ST2 is low, while ST1 is asserted. After the self test measurement is complete, bring both pins low to resume normal operation.

### FILTER

The ADXL358 uses an analog, low-pass, antialiasing filter to reduce out of band noise and to limit bandwidth.

The analog, low-pass antialiasing filter in the ADXL358 provides a fixed  $-3$  dB bandwidth of approximately 1.5 kHz, the frequency at which the voltage output response is attenuated by approximately 30%. The shape of the filter response in the frequency domain is that of a sinc filter. While the analog antialiasing filter attenuates the output response around and over its cutoff frequency, the MEMS sensor has a resonance at 5.5 kHz and mechanically amplifies the output response at around 2 kHz and over. These competing trends are apparent in the overall transfer function of the ADXL358, as shown in Figure 3 to Figure 5. Therefore, the overall  $-3$  dB bandwidth of the ADXL358 is 2.4 kHz, and the overall bandwidth with  $\pm 4$  dB flatness is about 4.4 kHz.

The ADXL358 x-axis, y-axis, and z-axis analog outputs include an amplifier followed by a series 32 k $\Omega$  resistor and output to the  $X_{\text{OUT}}$ , the  $Y_{\text{OUT}}$ , and the  $Z_{\text{OUT}}$  pins, respectively.

**RECOMMENDED SOLDERING PROFILE**

Figure 28 and Table 5 provide details about the recommended soldering profile.

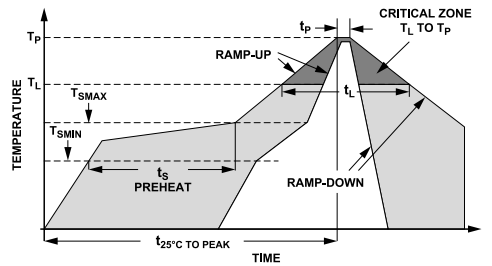

Figure 28. Recommended Soldering Profile

Table 5. Recommended Soldering Profile

Profile Feature	Condition	
	Sn63/Pb37	Pb-Free
Average Ramp Rate from Liquid Temperature ( $T_L$ ) to Peak Temperature ( $T_P$ )	3°C/sec maximum	3°C/sec maximum
Preheat		
Minimum Temperature ( $T_{SMIN}$ )	100°C	150°C
Maximum Temperature ( $T_{SMAX}$ )	150°C	200°C
Time from $T_{SMIN}$ to $T_{SMAX}$ ( $t_s$ )	60 sec to 120 sec	60 sec to 180 sec
$T_{SMAX}$ to $T_L$ Ramp-Up Rate	3°C/sec maximum	3°C/sec maximum
Liquid Temperature ( $T_L$ )	183°C	217°C
Time Maintained Above $T_L$ ( $t_L$ )	60 sec to 150 sec	60 sec to 150 sec
Peak Temperature ( $T_P$ )	+240°C + 0°C/-5°C	+260°C + 0°C/-5°C
Time of Actual $T_P$ - 5°C ( $t_p$ )	10 sec to 30 sec	20 sec to 40 sec
Ramp-Down Rate	6°C/sec maximum	6°C/sec maximum
Time from 25°C to Peak Temperature ( $t_{25^\circ\text{C TO PEAK}}$ )	6 minutes maximum	8 minutes maximum

**PCB FOOTPRINT PATTERN**

Figure 29 shows the PCB footprint pattern and dimensions in millimeters.

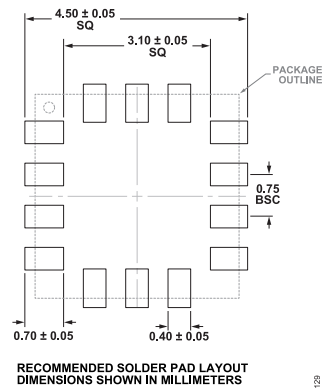

**Figure 29. PCB Footprint Pattern and Dimensions in Millimeters**