

Micropower, 3-Axis, $\pm 2 g/\pm 4 g/\pm 8 g$ Digital Output MEMS Accelerometer

FEATURES

- ▶ Supply voltage range
 - ▶ Single-cell battery operation: 1.1 V to 3.6 V
 - ▶ Internal power supply regulation for high PSRR
- ▶ Ultralow power
 - ▶ 0.89 μA at 100 Hz ODR, 2.0 V supply
 - ▶ 180 nA motion activated wake-up mode
 - ▶ 40 nA standby current
- ▶ High resolution: 0.25 mg/LSB
- ▶ Built-in features for system level power savings
 - ▶ Single-tap and double-tap detection with only 35 nA of added current
 - ▶ Adjustable threshold sleep and wake-up modes for motion activation
 - ▶ Autonomous interrupt processing, without need for microcontroller intervention, to allow the rest of the system to be turned off completely
 - ▶ Deep 512 sample embedded FIFO minimizes host processor load
 - ▶ Awake state output enables implementation of motion activated switch
- ▶ Low noise to 170 $\mu g/\sqrt{Hz}$
- ▶ Acceleration sample synchronization via external trigger
- ▶ On-chip temperature sensor
- ▶ Internal two-pole antialias filter
- ▶ SPI (4-wire) and I²C digital interfaces
- ▶ Small and thin 2.2 mm \times 2.3 mm \times 0.87 mm package

APPLICATIONS

- ▶ 24/7 sensing
- ▶ Hearing aids
- ▶ Vital signs monitoring devices
- ▶ Motion-enabled power save switches
- ▶ Motion-enabled metering devices
- ▶ Smart watch with single-cell operation
- ▶ Smart home

Analog Devices is in the process of updating documentation to provide terminology and language that is culturally appropriate. This is a process with a wide scope and will be phased in as quickly as possible. Thank you for your patience.

FUNCTIONAL BLOCK DIAGRAM

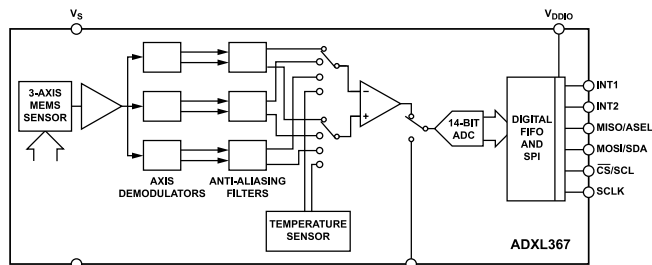

Figure 1.

GENERAL DESCRIPTION

The ADXL367 is an ultralow power, 3-axis microelectromechanical systems (MEMS) accelerometer that consumes only 0.89 μA at a 100 Hz output data rate and 180 nA when in motion-triggered wake-up mode. Unlike accelerometers that use power duty cycling to achieve low power consumption, the ADXL367 does not alias input signals by undersampling, but samples the full bandwidth of the sensor at all data rates.

The ADXL367 always provides 14-bit output resolution. 8-bit formatted data is offered for more efficient single-byte transfers when a lower resolution is sufficient. 12-bit formatted data is also provided for ADXL362 design compatibility. Measurement ranges of $\pm 2 g$, $\pm 4 g$, and $\pm 8 g$ are available, with a resolution of 0.25 mg/LSB on the $\pm 2 g$ range.

In addition to its ultralow power consumption, the ADXL367 has many features to enable true system level power reduction. It includes a deep multimode output first in, first out (FIFO), a built-in micropower temperature sensor, an internal analog-to-digital converter (ADC) for synchronous conversion of an additional analog input with interrupt capability, single-tap and double-tap detection that can operate at any output data rate with only an added 35 nA of current, and a state machine to prevent a false triggering. In addition, the ADXL367 has provisions for external control of the sampling time and/or an external clock.

The ADXL367 operates on a wide 1.1 V to 3.6 V supply range, and can interface, if necessary, to a host operating on a separate supply voltage. The ADXL367 is available in a 2.2 mm \times 2.3 mm \times 0.87 mm package.

TABLE OF CONTENTS

Features.....	1	X-Data Bits[13:6] Register.....	32
Applications.....	1	Y-Data Bits[13:6] Register.....	33
Functional Block Diagram.....	1	Z-Data Bits[13:6] Register.....	33
General Description.....	1	Status Register.....	33
Specifications.....	4	FIFO Entries Bits[7:0] Register.....	34
Timing Specifications.....	5	FIFO Entries Bits[9:8] Register.....	34
Absolute Maximum Ratings	11	X-Data Bits[13:6] Register.....	34
Thermal Resistance.....	11	X-Data Bits[5:0] Register.....	35
Electrostatic Discharge (ESD) Ratings.....	11	Y-Data Bits[13:6] Register.....	35
Recommended Soldering Profile.....	11	Y-Data Bits[5:0] Register.....	35
ESD Caution.....	11	Z-Data Bits[13:6] Register.....	35
Pin Configuration and Function Descriptions.....	12	Z-Data Bits[5:0] Register.....	36
Typical Performance Characteristics.....	13	Temperate Data Bits[13:6] Register.....	36
Theory of Operation.....	17	Temperate Data Bits[5:0] Register.....	36
Mechanical Device Operation.....	17	ADC Data Bits[13:6] Register.....	36
Operating Modes.....	17	ADC Data Bits[5:0] Register.....	37
Selectable Measurement Ranges.....	18	I ² C FIFO Data Register.....	37
Selectable Output Data Rates.....	18	Soft Reset Register.....	37
Power/Noise Tradeoff.....	18	Threshold Activity Bits[12:6] Register.....	38
Temperature Sensor.....	18	Threshold Activity Bits[5:0] Register.....	38
External ADC.....	18	Timed Activity Register.....	38
Power Savings Features.....	20	Threshold Inactivity Bits[12:6] Register.....	39
Ultralow Power Consumption in All Modes.....	20	Threshold Inactivity Bits[5:0] Register.....	39
External ADC Interrupt.....	20	Timed Inactivity Bits[15:8] Register.....	39
Motion Detection.....	20	Timed Inactivity Bits[7:0] Register.....	40
FIFO.....	23	Activity Inactivity Control Register.....	40
Communications.....	23	FIFO Control Register.....	40
Additional Features.....	25	FIFO Sample Register.....	42
Free Fall Detection.....	25	Interrupt Pin 1 Enables (Lower) Register.....	42
Tap Detection.....	25	Interrupt Pin 2 Enables (Lower) Register.....	43
External Clock.....	25	Filter Control Register.....	44
External Trigger	25	Power Control Register.....	44
Self Test.....	25	User Self Test Register.....	45
User Register Protection.....	26	Tap Threshold Register.....	45
Serial Communications.....	27	Tap Duration Register.....	45
SPI Commands.....	27	Tap Latency Register.....	46
Multibyte Transfers.....	27	Tap Window Register.....	46
Invalid Addresses and Address Aliasing.....	27	X-Axis User Offset Register.....	46
Latency Restrictions.....	27	Y-Axis User Offset Register.....	46
Invalid Commands.....	27	Z-Axis User Offset Register.....	47
SPI Bus Sharing.....	27	X-Axis User Sensitivity Register.....	47
I ² C.....	28	Y-Axis User Sensitivity Register.....	47
Register Map.....	29	Z-Axis User Sensitivity Register.....	48
Register Details.....	31	Timer Control Register.....	48
ADI Device ID Register.....	31	Interrupt Pin 1 Enables (Upper) Register.....	49
MEMS Device ID Register.....	31	Interrupt Pin 2 Enables (Upper) Register.....	49
Part ID Register.....	31	ADC Control Register.....	50
Revision ID Register.....	31	Temperature Configuration Register.....	51
XID Registers.....	31	TEMP_ADC_ACT_THRSH_HIGH Register.....	51

TABLE OF CONTENTS

TEMP_ADC_ACT_THRSH_LOW Register.....	51	FIFO Modes.....	57
TEMP_ADC_INACT_THRSH_HIGH Register.....	52	FIFO Configuration.....	58
TEMP_ADC_INACT_THRSH_LOW Register..	52	Interrupts.....	60
Temperature Activity Inactivity Timer Register.....	52	Using External Trigger.....	61
Axis Mask Register.....	53	Using an External Clock.....	62
Status Copy Register.....	53	Using Self Test	62
Status 2 Register.....	54	Operation at Voltages Other Than 2.0 V.....	62
Applications Information.....	55	Mechanical Considerations for Mounting.....	62
Application Examples.....	55	Axes of Acceleration Sensitivity.....	63
Power Supply Requirements.....	56	Outline Dimensions.....	64
		Ordering Guide.....	64
		Evaluation Boards.....	64

REVISION HISTORY**3/2022 —Revision 0: Initial Version**

SPECIFICATIONS

$T_A = 25^\circ\text{C}$, $V_S = 2.0\text{ V}$, $V_{\text{DDIO}} = 2.0\text{ V}$, 100 Hz ODR, $\pm 2\text{ g}$ range, acceleration = 0 g, default settings for other registers, unless otherwise noted.

Table 1.

Parameter ¹	Test Conditions/Comments	Min	Typ	Max	Unit	
SENSOR INPUT						
Measurement Range	Each axis User selectable		$\pm 2, \pm 4, \pm 8$		g	
Nonlinearity	Percentage of full scale (2 g)				%	
Sensor Resonant Frequency	X-axis, y-axis		0.5		%	
	Z-axis		1.8		%	
	X-axis, y-axis ²		2170		Hz	
Cross Axis Sensitivity ⁴	Z-axis ³		3000		Hz	
			0.8		%	
OUTPUT RESOLUTION						
All g Ranges	Each axis		14		Bits	
SENSITIVITY						
Scale Factor	Each axis					
	2 g range		0.25		mg/LSB	
	4 g range		0.5		mg/LSB	
	8 g range		1		mg/LSB	
Sensitivity	2 g range		4000		LSB/g	
	4 g range		2000		LSB/g	
	8 g range		1000		LSB/g	
Sensitivity Change Due to Temperature ⁵	0°C to 60°C		0.05		%/°C	
0 g OFFSET						
0 g Output ⁶	Each axis					
	$X_{\text{OUT}}, Y_{\text{OUT}}$	-150	± 35	+150	mg	
0 g Offset vs. Temperature ⁷	Z_{OUT}	-250	± 50	+250	mg	
			0.6		mg/°C	
NOISE PERFORMANCE						
Noise Density						
	Normal Operation		370		$\mu\text{g}/\sqrt{\text{Hz}}$	
	Low Noise Mode		200		$\mu\text{g}/\sqrt{\text{Hz}}$	
	400 ODR		170		$\mu\text{g}/\sqrt{\text{Hz}}$	
BANDWIDTH						
Low Pass (Antialiasing) Filter, -3 dB Corner	2 pole filter		ODR/2		Hz	
Output Data Rate (ODR)	User selectable in 8 steps	12.5		400	Hz	
SELF TEST						
Output Change ⁸	X_{OUT}	90	180	270	mg	
POWER SUPPLY						
Operating Voltage Range (V_S)		1.1	2.0	3.6	V	
I/O Voltage Range (V_{DDIO})		1.1	2.0	3.6	V	
Supply Reset Threshold (V_{RESET})				50	mV	
Supply Current ⁹						
Measurement Mode ¹⁰	100 Hz ODR (50 Hz bandwidth)					
		Normal Operation		0.89		μA
		Low Noise Mode		1.77		μA
Wake-Up Mode ¹¹			181		nA	
Standby			40		nA	
Power Supply Rejection Ratio (PSRR)	External capacitors removed, input is 100 mV sine wave on the supply voltage on the V_S pin (V_S)					
Input Frequency 100 Hz to 1 kHz			-59		dB	

SPECIFICATIONS

Table 1.

Parameter ¹	Test Conditions/Comments	Min	Typ	Max	Unit
Input Frequency 1 kHz to 250 kHz			-47		dB
Turn-On Time ¹²	100 Hz ODR (50 Hz bandwidth)				
Power-Up to Standby			9		ms
Hold Time		300			ms
Rise Time	0 V to 90% of V_S	4			ms
Measurement Mode Instruction to Valid Data			31		ms
TEMPERATURE SENSOR					
Bias Average	at 25°C		165		LSB
Standard Deviation			428		LSB
Sensitivity Average			54		LSB/°C
Standard Deviation			0.72		LSB/°C
Resolution			14		Bits
ENVIRONMENTAL					
Operating Temperature Range		-40		+85	°C

¹ All minimum and maximum specifications are guaranteed. Typical specifications may not be guaranteed.

² Typical value based on characterization, not tested in production.

³ Typical value defined based on design/simulation. It is not tested in production.

⁴ Cross axis sensitivity is defined as coupling between any two axes. Typical value based on characterization, not tested in production.

⁵ 0°C to +25°C or +25°C to +60°C

⁶ Different supplies and measurement range cause different offset.

⁷ -40°C to +25°C or +25°C to +85°C.

⁸ Self test change is defined as the output change in g when self test is asserted. Different supplies and g ranges cause different self test changes.

⁹ Supply current may increase when temperature sensor, FIFO, or external ADC are enabled.

¹⁰ Tested under 2.0 V V_S and V_{DDIO} .

¹¹ Wake-up mode current consumption when sampling at 1.5625 samples per second. This can be configured in the WAKEUP_RATE bit field in Register 0x39.

¹² Refer to the [Power Supply Requirements](#) section for the minimum supply rise time requirement in details

TIMING SPECIFICATIONS

Table 2. SPI Digital Input/Output

Parameter	Test Conditions/Comments	Limit ¹		Unit
		Min	Max	
Digital Input				
Low Level Input Voltage (V_{IL})			$0.3 \times V_{DDIO}$	V
High Level Input Voltage (V_{IH})		$0.7 \times V_{DDIO}$		V
Low Level Input Current (I_{IL})	$V_{IN} = V_{DDIO}$		0.1	μ A
High Level Input Current (I_{IH})	$V_{IN} = 0$ V	-0.1		μ A
Digital Output				
Low Level Output Voltage (V_{OL})	$I_{OL} = 10$ mA		$0.2 \times V_{DDIO}$	V
High Level Output Voltage (V_{OH})	$I_{OH} = -4$ mA	$0.8 \times V_{DDIO}$		V
Low Level Output Current (I_{OL})	$V_{OL} = V_{OL, max}$	10		mA
High Level Output Current (I_{OH})	$V_{OH} = V_{OH, min}$		-4	mA

¹ Limits based on characterization results, not production tested.

SPECIFICATIONS

Table 3. SPI Timing ($T_A = 25^\circ\text{C}$, $V_S = 2.0\text{ V}$, $V_{DDIO} = 2.0\text{ V}$)

Limit ^{1, 2, 3}				
Parameter	Min	Max	Unit	Description
f_{CLK}	0.1	8	MHz	Clock Frequency.
t_{CSS}	100		ns	$\overline{\text{CS}}$ Setup Time.
t_{CSH}	0.02	1000	μs	$\overline{\text{CS}}$ Hold Time.
t_{CSD}	20		ns	$\overline{\text{CS}}$ Disable Time.
t_{SU}	20		ns	Data Setup Time.
t_{HD}	20		ns	Data Hold Time.
t_{HIGH}	50		ns	Clock High Time.
t_{LOW}	50		ns	Clock Low Time.
t_{CLE}	25		ns	Clock Enable Time.
t_{V}	0	50	ns	Output Valid from Clock Low.
t_{DIS}	0	25	ns	Output Disable Time.

¹ Limits based on design targets, not production tested.

² The timing values are measured corresponding to the input thresholds (V_{IL} and V_{IH}) given in Table 2.

³ Maximum loading must not exceed 12 pF.

Table 4. I²C Timing ($T_A = 25^\circ\text{C}$, $V_S = 2.0\text{ V}$, $V_{DDIO} = 2.0\text{ V}$)

Parameter	Symbol	Test Conditions/ Comments	I ² C_HS = 0 (Fast Mode)			I ² C_HS = 1 (High Speed Mode)			Unit
			Min	Typ	Max	Min	Typ	Max	
DC INPUT LEVELS									
Input Voltage									
Low Level	V_{IL}				$0.3 \times V_{\text{DDIO}}$			$0.3 \times V_{\text{DDIO}}$	V
High Level	V_{IH}		$0.7 \times V_{\text{DDIO}}$			$0.7 \times V_{\text{DDIO}}$			V
Hysteresis of Schmitt Trigger Inputs	V_{HYS}		$0.05 \times V_{\text{DDIO}}$			$0.1 \times V_{\text{DDIO}}$			μA
Input Current	I_{IL}	$0.1 \times V_{\text{DDIO}} < V_{\text{IN}} < 0.9 \times V_{\text{DDIO}}$	-10		+10				μA
DC OUTPUT LEVELS									
Output Voltage									
Low Level	V_{OL1}	$I_{\text{OL}} = 7\text{ mA}$ $V_{\text{DDIO}} > 2\text{ V}$			0.4				V
	V_{OL2}	$V_{\text{DDIO}} \leq 2\text{ V}$			$0.2 \times V_{\text{DDIO}}$				V
Output Current									
Low Level	I_{OL}	$V_{\text{OL}} = 0.4\text{ V}$ $V_{\text{OL}} = 0.6\text{ V}$	20 6						mA mA
AC INPUT LEVELS									
SCLK Frequency			0		1	0		3.4	MHz
SCL High Time	t_{HIGH}		260			60			ns
SCL Low Time	t_{LOW}		500			160			ns
Start Setup Time	t_{SUSTA}		260			160			ns
Start Hold Time	t_{HDSTA}		260			160			ns
SDA Setup Time	t_{SUDAT}		50			10			ns
SDA Hold Time	t_{HDDAT}		0			0			ns
Stop Setup Time	t_{SUSTO}		260			160			ns
Bus Free Time	t_{BUF}		500						ns
SCL Input Rise Time	t_{RCL}				120			80	ns
SCL Input Fall Time	t_{FCL}				120			80	ns

SPECIFICATIONS

Table 4. I²C Timing (T_A = 25°C, V_S = 2.0 V, V_{DDIO} = 2.0 V)

Parameter	Symbol	Test Conditions/ Comments	I2C_HS = 0 (Fast Mode)			I2C_HS = 1 (High Speed Mode)			Unit
			Min	Typ	Max	Min	Typ	Max	
SDA Input Rise Time	t _{RDA}				120			160	ns
SDA Input Fall Time	t _{FDA}				120			160	ns
Width of Spikes to Suppress	t _{SP}	Not shown in Figure 17			50			10	ns
AC OUTPUT LEVELS									
Propagation Delay		C _{LOAD} = 500 pF							
Data	t _{VDDAT}		97		450	27		135	ns
Acknowledge	t _{VDAK}				450				ns
Output Fall Time	t _F	Not shown in Figure 17	20 × (V _{DDIO} /5.5)		120				ns

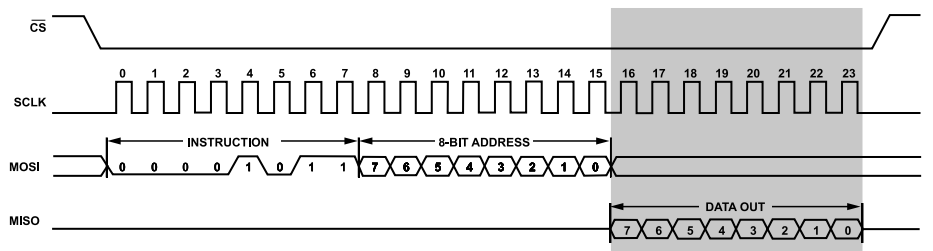

Figure 2. Register Read

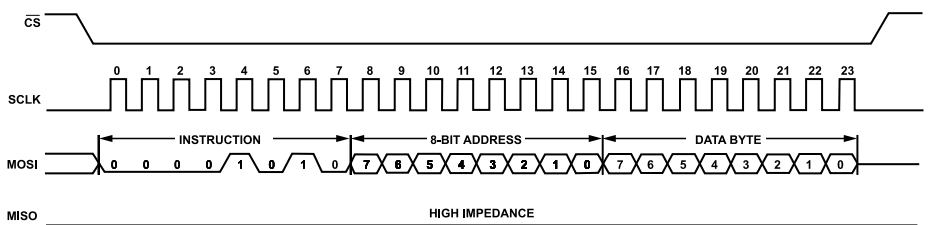

Figure 3. Register Write (Receive Instruction Only)

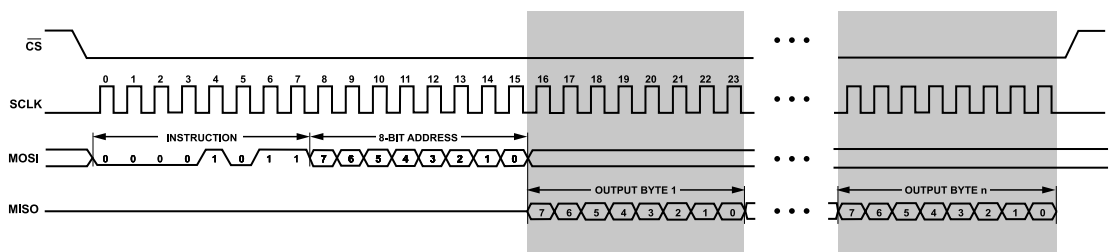

Figure 4. Burst Read

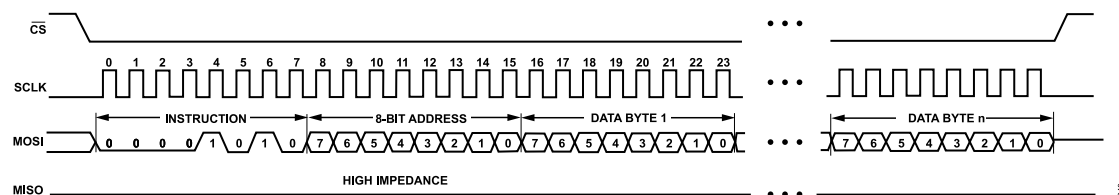

Figure 5. Burst Write (Receive Instruction Only)

SPECIFICATIONS

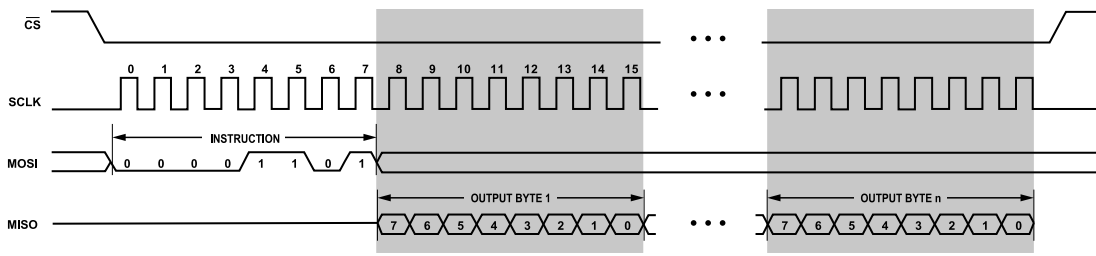

Figure 6. FIFO Read

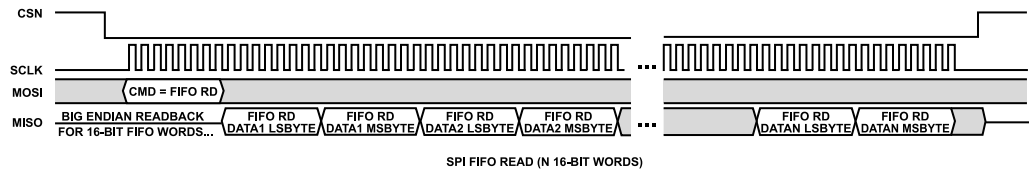

Figure 7. SPI FIFO Read (N 16-Bit Words)

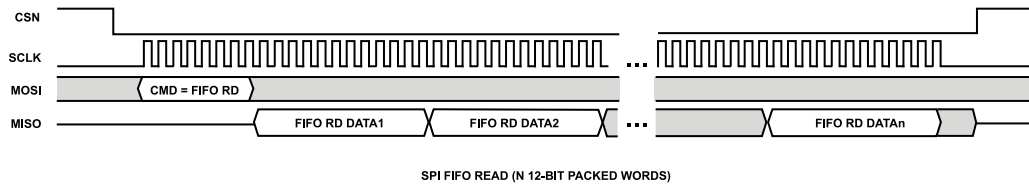

Figure 8. SPI FIFO Read (N 12-Bit Packed Words)

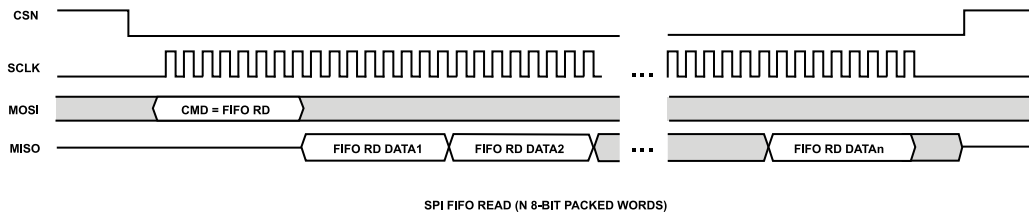

Figure 9. SPI FIFO Read (N 8-Bit Packed Words)

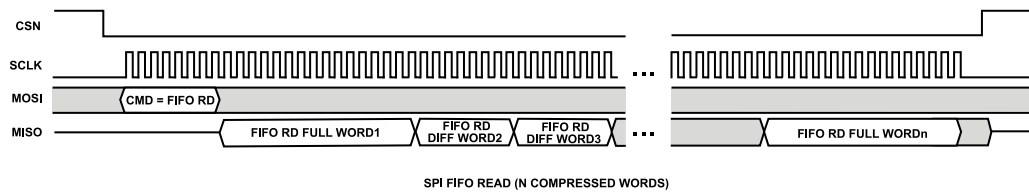

Figure 10. SPI FIFO Read (N Compressed Words)

SPECIFICATIONS

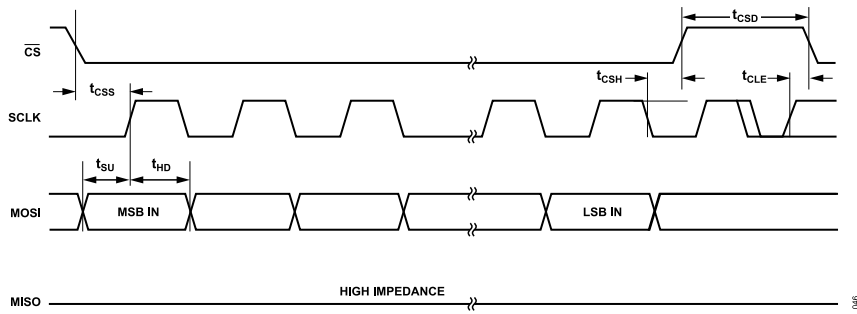

Figure 11. Timing Diagram for SPI Receive Instructions

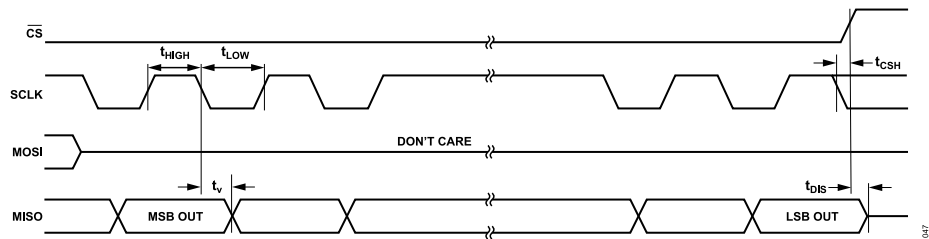

Figure 12. Timing Diagram for SPI Send Instructions

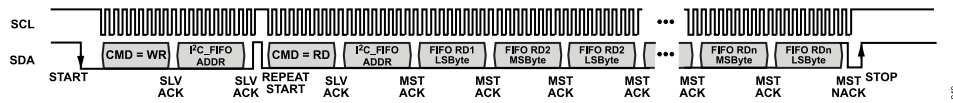

Figure 13. I2C FIFO Read (N 16-Bit Words)

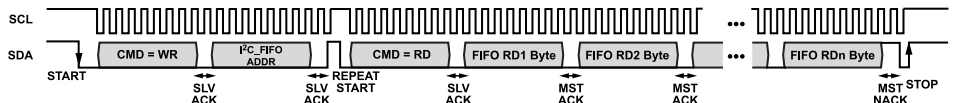

Figure 14. I2C FIFO Read (N 8-Bit Words)

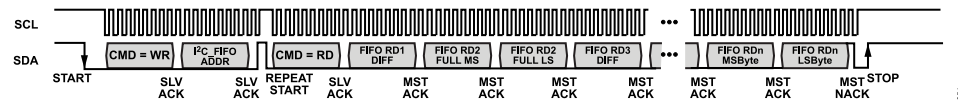

Figure 15. I2C FIFO Read (N Compressed Words, 8-Bit or 16-Bit)

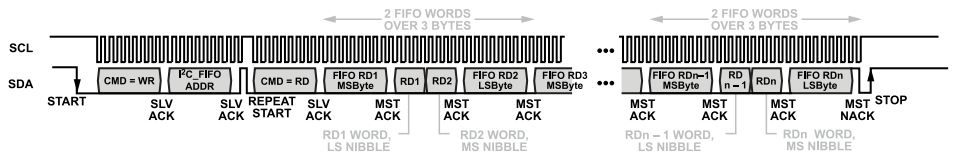

Figure 16. I2C FIFO Read (N 12-Bit Words)

SPECIFICATIONS

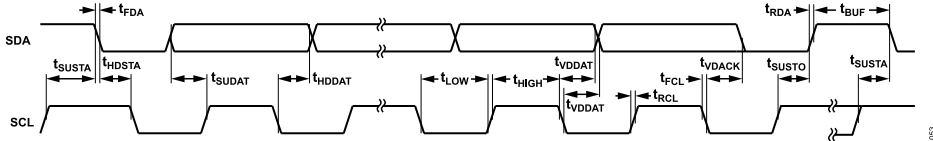

Figure 17. I²C Interface Timing Diagram

ABSOLUTE MAXIMUM RATINGS

Table 5.

Parameter	Rating
Acceleration (Any Axis, Unpowered)	5000 g
Acceleration (Any Axis, Powered)	5000 g
V _S	-0.3 V to +4.0 V
V _{DDIO}	-0.3 V to +4.0 V
All Other Pins	-0.3 V to V _{DDIO}
Output Short-Circuit Duration (Any Pin to Ground)	Indefinite
Temperature Range (Storage)	-50°C to +150°C

Stresses at or above those listed under Absolute Maximum Ratings may cause permanent damage to the product. This is a stress rating only; functional operation of the product at these or any other conditions above those indicated in the operational section of this specification is not implied. Operation beyond the maximum operating conditions for extended periods may affect product reliability.

THERMAL RESISTANCE

Thermal resistance values specified in Table 6 are simulated based on JEDEC specs (unless specified otherwise) and should be used in compliance with JESD51-12.

Table 6. Thermal Resistance

Package Type	θ_{JA}	θ_{JC}	Ψ_{iJT}	Ψ_{iJB}	Device Weight
CC-12-4	177.8 °C/W	116.7 °C/W	11.1°C/W	127.8 °C/W	9.04 mg

ELECTROSTATIC DISCHARGE (ESD) RATINGS

The following ESD information is provided for handling of ESD-sensitive devices in an ESD protected area only.

Human body model (HBM) per ANSI/ESDA/JEDEC JS-001.

Charged device model (CDM) per ANSI/ESDA/JEDEC JS-002.

Table 7. ADXL367, 12-Terminal LGA

ESD Model	Withstand Threshold (V)	Class
HBM	2000	2
CDM	1250	C3

RECOMMENDED SOLDERING PROFILE

Table 8 provides details about the recommended soldering profile.

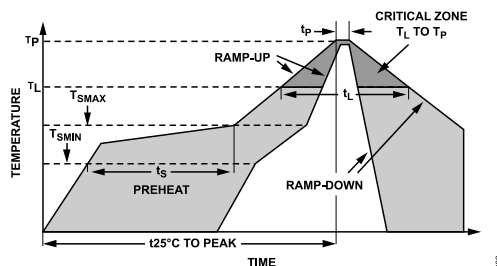

Figure 18. Recommended Soldering Profile

Table 8. Recommended Soldering Profile

Profile Feature	Condition	
	Sn63/Pb37	Pb-Free
Average Ramp Rate (T _L to T _P)	3°C/sec max	3°C/sec max
Preheat		
Minimum Soldering Temperature (T _S MIN)	100°C	150°C
Maximum Soldering Temperature (T _S MAX)	150°C	200°C
Soldering Time (T _S MIN to T _S MAX)(t _s)	60 sec to 120 sec	60 sec to 180 sec
T _S MAX to T _L Ramp-Up Rate	3°C/sec maximum	3°C/sec maximum
Time Maintained Above Liquidous Temperature (T _L)		
Liquidous Temperature (T _L)	183°C	217°C
Liquidous Time (t _L)	60 sec to 150 sec	60 sec to 150 sec
Peak Temperature (T _P)	240 + 0°C/-5°C	260 + 0°C/-5°C
Time Within 5°C of Actual Peak Temperature (t _p)	10 sec to 30 sec	20 sec to 40 sec
Ramp-Down Rate	6°C/sec maximum	6°C/sec maximum
Time at 25°C to Peak Temperature	6 minutes maximum	8 minutes maximum

ESD CAUTION



ESD (electrostatic discharge) sensitive device. Charged devices and circuit boards can discharge without detection. Although this product features patented or proprietary protection circuitry, damage may occur on devices subjected to high energy ESD. Therefore, proper ESD precautions should be taken to avoid performance degradation or loss of functionality.

PIN CONFIGURATION AND FUNCTION DESCRIPTIONS

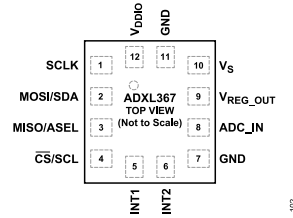

Figure 19. Pin Configuration

Table 9. Pin Function Descriptions

Pin No.	Mnemonic	Description
1	SCLK	SPI Communication Clock. Tied low for I ² C.
2	MOSI/SDA	Master Output, Slave Input (MOSI), I ² C Serial Data (SDA).
3	MISO/ASEL	Master Input, Slave Output (MISO), I ² C Address Select (ASEL).
4	CS/SCL	SPI Chip Select, Active Low (\overline{CS}), I ² C Clock (SCL).
5	INT1	Interrupt 1 Output. INT1 also serves as an input for external clocking.
6	INT2	Interrupt 2 Output. INT2 also serves as an input for synchronized sampling.
7	GND	Ground. This pin must be grounded.
8	ADC_IN	ADC Input Pin. Can be left unconnected, or connected to Pin 7 and/or Pin 11.
9	VREG_OUT ¹	Internally Regulated Voltage.
10	V _S	Supply Voltage.
11	GND	Ground. This pin must be grounded.
12	V _{DDIO}	Supply Voltage for Digital I/O.

¹ This pin is used as an internal supply decoupling pin, an external 0.2 μ F capacitor is needed.

TYPICAL PERFORMANCE CHARACTERISTICS

$T_A = 25^\circ\text{C}$, $V_S = 2.0\text{ V}$, $V_{DDIO} = 2.0\text{ V}$, 100 Hz ODR, $\pm 2\text{ g}$ range, acceleration = 0 g, default settings for other registers, unless otherwise noted.

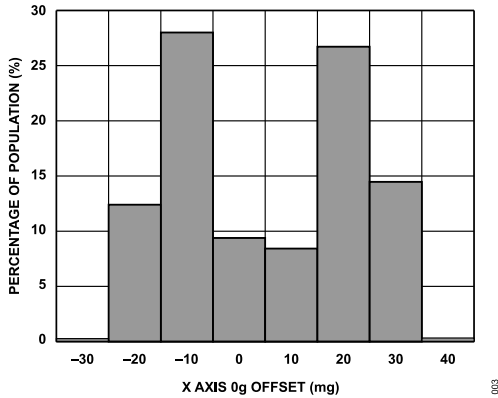

Figure 20. X-Axis Zero g Offset at 25°C, $V_S = 2\text{ V}$

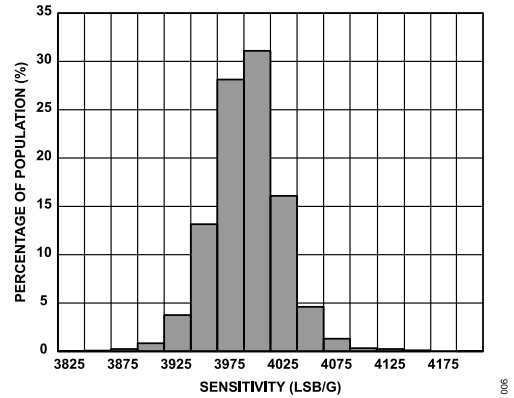

Figure 23. X-Axis Sensitivity at 25°C, $V_S = 2\text{ V}$, $\pm 2\text{ g}$ Range

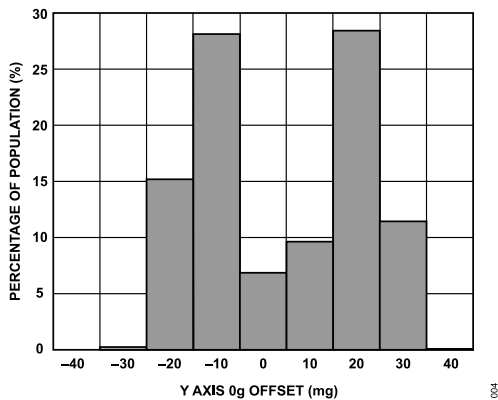

Figure 21. Y-Axis Zero g Offset at 25°C, $V_S = 2\text{ V}$

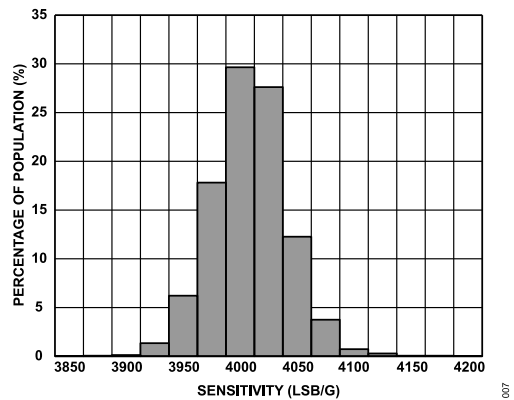

Figure 24. Y-Axis Sensitivity at 25°C, $V_S = 2\text{ V}$, $\pm 2\text{ g}$ Range

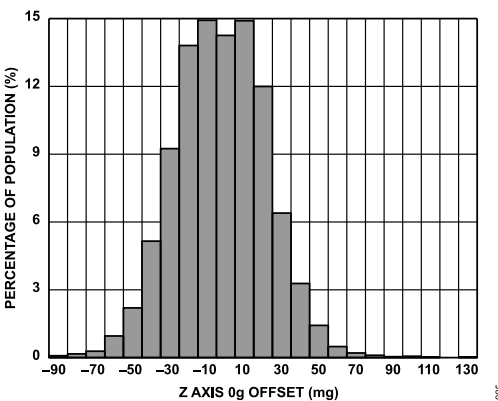

Figure 22. Z-Axis Zero g Offset at 25°C, $V_S = 2\text{ V}$

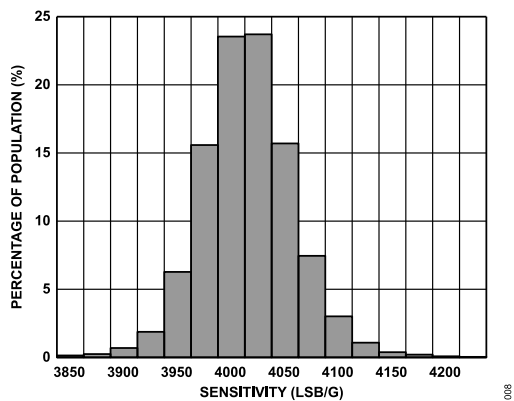

Figure 25. Z-Axis Sensitivity at 25°C, $V_S = 2\text{ V}$, $\pm 2\text{ g}$ Range

TYPICAL PERFORMANCE CHARACTERISTICS

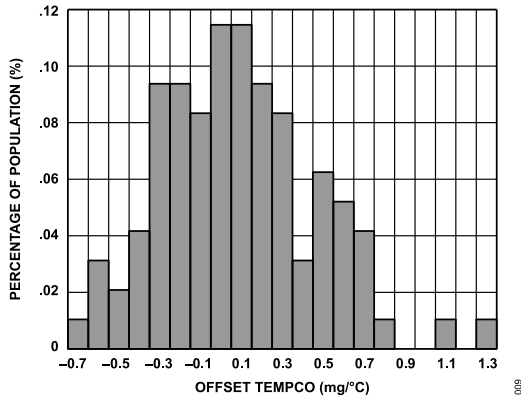

Figure 26. X-Axis Zero g Offset Temperature Coefficient, $V_S = 2\text{ V}$

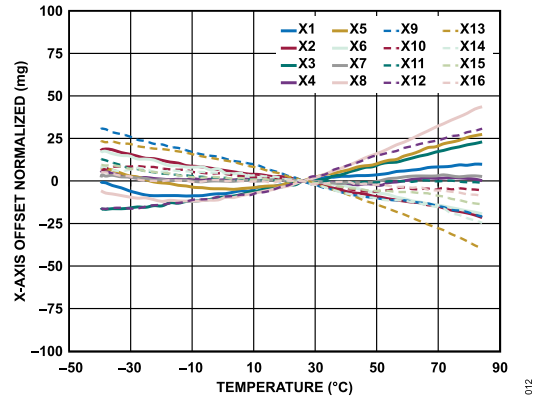

Figure 29. X-Axis Offset Normalized vs. Temperature, 16 ADXL367 Devices Soldered to PCB, ODR = 100 Hz, $V_S = 2\text{ V}$

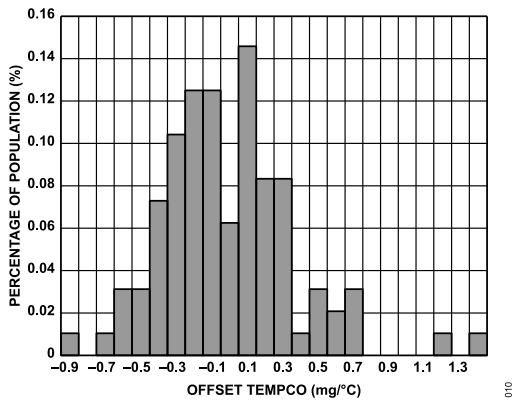

Figure 27. Y-Axis Zero g Offset Temperature Coefficient, $V_S = 2\text{ V}$

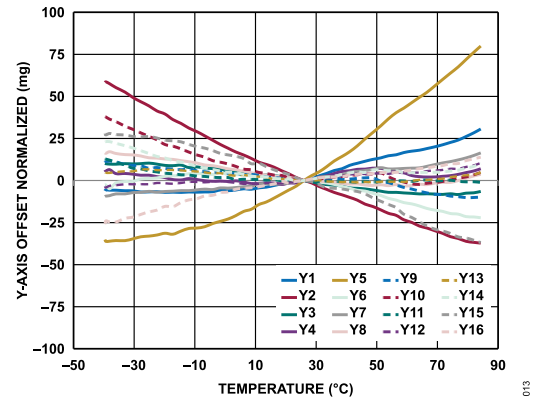

Figure 30. Y-Axis Offset Normalized vs. Temperature, 16 ADXL367 Devices Soldered to PCB, ODR = 100 Hz, $V_S = 2\text{ V}$

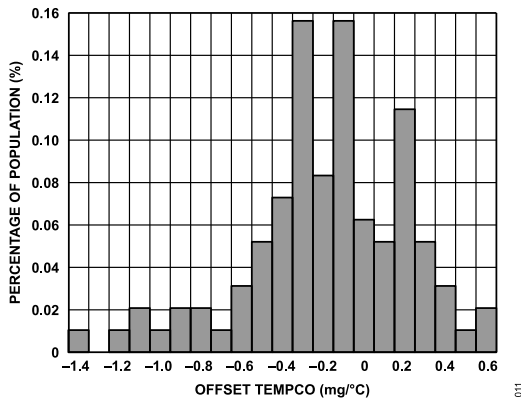

Figure 28. Z-Axis Zero g Offset Temperature Coefficient, $V_S = 2\text{ V}$

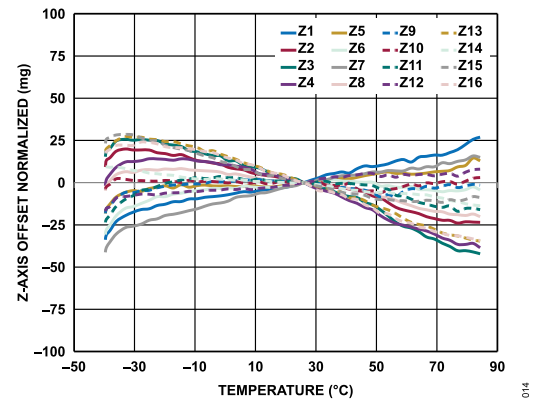

Figure 31. Z-Axis Offset Normalized vs. Temperature, 16 ADXL367 Devices Soldered to PCB, ODR = 100 Hz, $V_S = 2\text{ V}$

TYPICAL PERFORMANCE CHARACTERISTICS

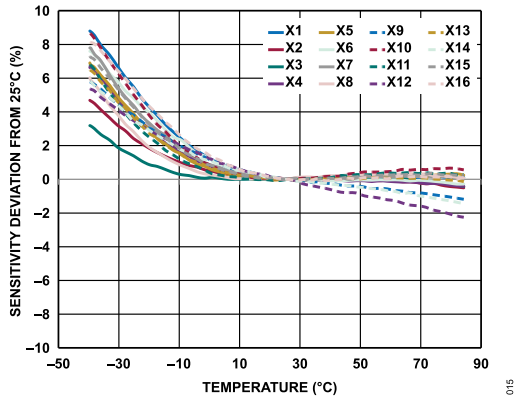

Figure 32. Sensitivity Deviation from 25°C vs. Temperature, 16 ADXL367 Devices Soldered to PCB, ODR = 100 Hz, $V_S = 2\text{ V}$, X-Axis

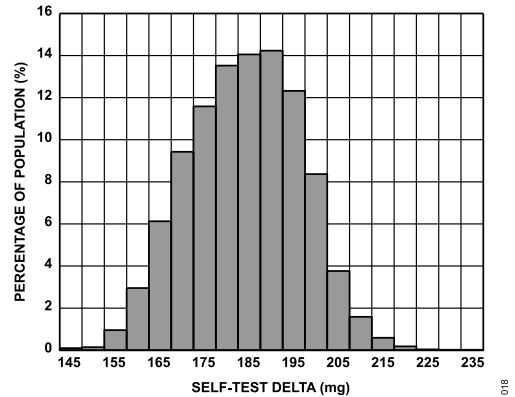

Figure 35. X-Axis Self Test Response at 25°C, $V_S = 2\text{ V}$

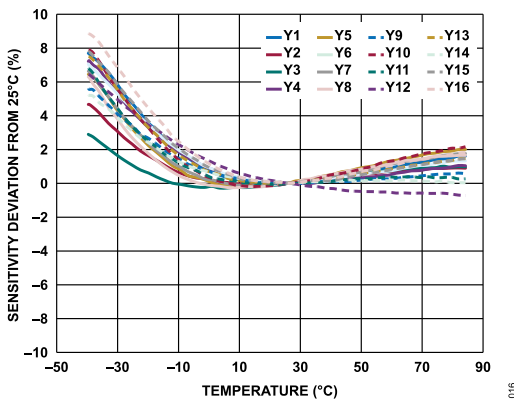

Figure 33. Sensitivity Deviation from 25°C vs. Temperature, 16 ADXL367 Devices Soldered to PCB, ODR = 100 Hz, $V_S = 2\text{ V}$, Y-Axis

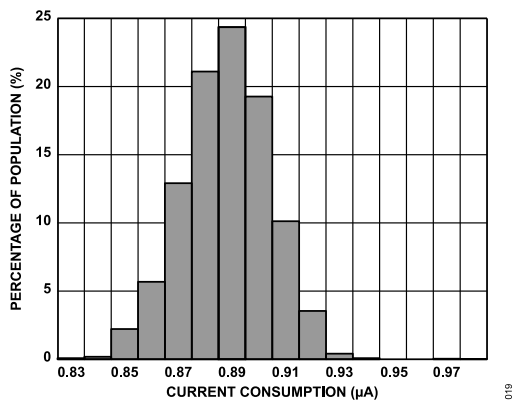

Figure 36. Current Consumption at 25°C, Normal Mode, ODR = 100 Hz, $V_S = 2\text{ V}$

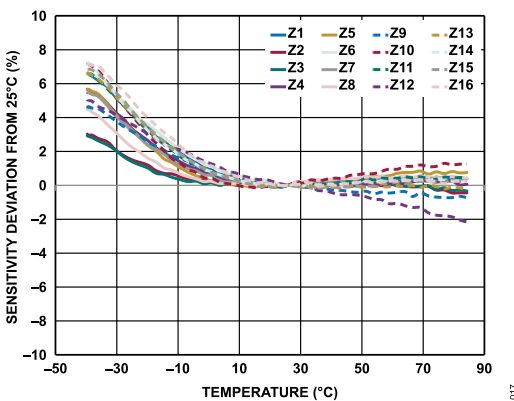

Figure 34. Sensitivity Deviation from 25°C vs. Temperature, 16 ADXL367 Devices Soldered to PCB, ODR = 100 Hz, $V_S = 2\text{ V}$, Z-Axis

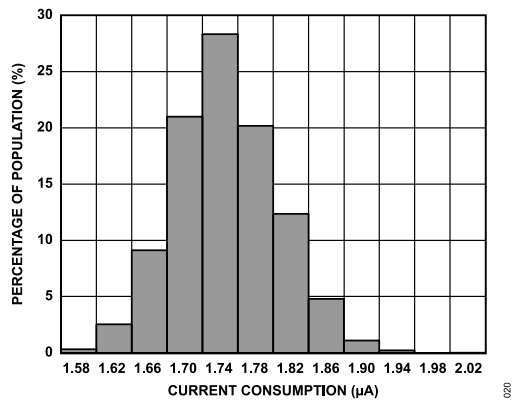

Figure 37. Current Consumption at 25°C, Low Noise Mode, ODR = 100 Hz, $V_S = 2\text{ V}$

TYPICAL PERFORMANCE CHARACTERISTICS

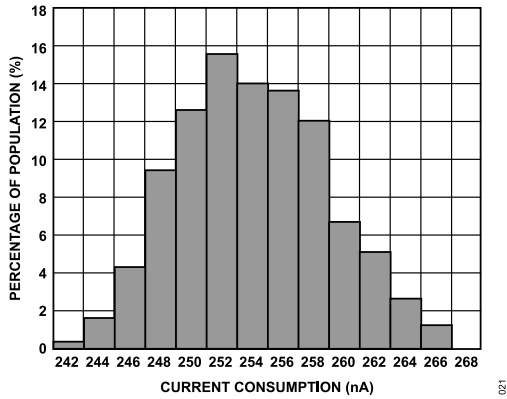

Figure 38. Current Consumption at 25°C, Wake-Up Mode, $V_S = 2 V$

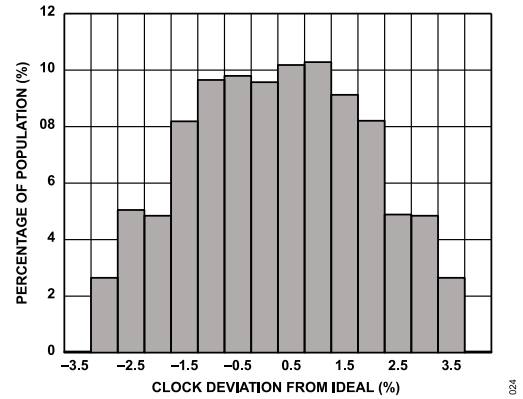

Figure 41. Clock Frequency Deviation from Ideal at 25°C, $V_S = 2 V$

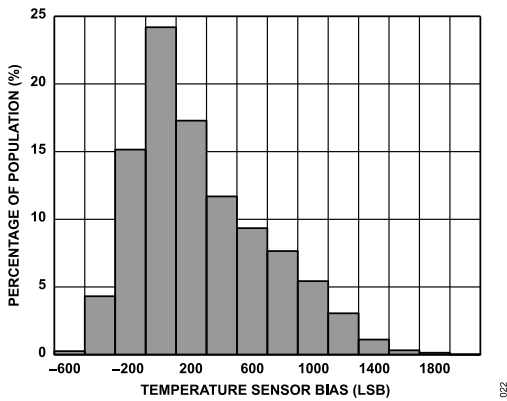

Figure 39. Temperature Sensor Response at 25°C, $V_S = 2 V$

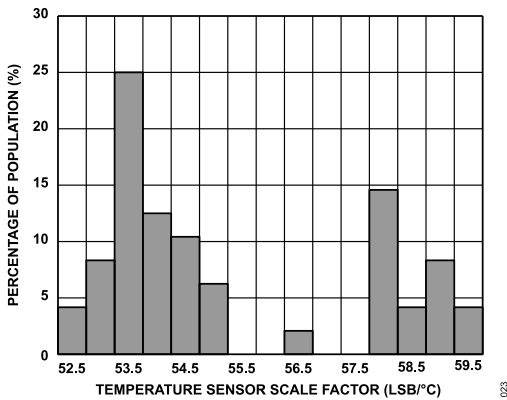

Figure 40. Temperature Sensor Scale Factor, $V_S = 2 V$

THEORY OF OPERATION

The ADXL367 is a complete 3-axis acceleration measurement system that operates at extremely low power consumption levels. The ADXL367 measures both dynamic acceleration, resulting from motion or shock, and static acceleration, such as tilt. Acceleration is reported digitally and the device communicates via either the SPI or the I²C protocol. Built-in digital logic enables autonomous operation and implements functionality that enhances system level power savings.

MECHANICAL DEVICE OPERATION

The moving component of the sensor is a polysilicon surface-machined structure that is built on top of a silicon wafer. Polysilicon springs suspend the structure over the surface of the wafer and provide a resistance against acceleration forces.

Deflection of the structure is measured using differential capacitors that consist of independent fixed plates and plates attached to the moving mass. Acceleration deflects the structure and unbalances the differential capacitor, resulting in a sensor output whose amplitude is proportional to acceleration. Phase sensitive demodulation determines the magnitude and polarity of the acceleration.

OPERATING MODES

The ADXL367 has the following three operating modes:

- ▶ Measurement mode for continuous, wide bandwidth sensing
- ▶ Wake-up mode for limited bandwidth activity detection
- ▶ Standby mode for power conservation

Measurement Mode

Measurement mode is the normal operating mode of the ADXL367. In this mode, acceleration data is read continuously and the accelerometer consumes 1.4 μ A (typical) across its entire range of output data rates of up to 400 Hz on a single button-cell battery (at 25°C). All features described in this data sheet are available when operating the ADXL367 in this mode.

The ADXL367 is a true ultra low power accelerometer because its supply current is 0.8 μ A at 100 Hz ODR. Other accelerometers derive low current by using a specific low power mode that power cycles acceleration sensing. The resulting undersampling can lead to aliasing of the input acceleration. The ADXL367 does not undersample the input signal at any of its output data rates when in measure mode.

Note that after entering measurement mode, a 100 ms wait time must be observed before reading acceleration data. This allows the output time to settle after entering measurement mode.

Wake-Up Mode

Wake-up mode reduces current consumption to a very low level by sampling the input periodically, and turning the accelerometer electronics off between measurements. This mode is often used to

distinguish between the presence and absence of motion, but can also be used as a live data stream.

The ADXL367 offers 4 user-selectable wake-up rates ranging from approximately 12.5 samples per second to approximately 1.5 samples per second. In wake-up mode, acceleration is measured at regular intervals. Between samples, the accelerometer electronics are in a lower power state (see Figure 42).

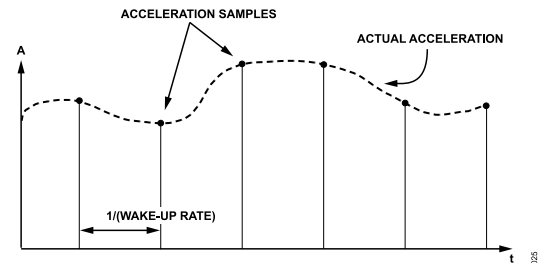

Figure 42. Acceleration Sampling

Wake-up mode is ideal for implementation of a motion-activated on/off switch. For many systems, a few measurements per second are sufficient to detect movements that can wake up the system. After the system is awake, it can switch into a higher data rate mode for more precise motion measurements. Note that time duration for the first wake-up is longer than subsequent.

In wake-up mode, if motion is detected, the accelerometer can respond autonomously in any the following ways:

- ▶ Remain in wake-up mode and continue to sample data, when activity interrupt is not triggered
- ▶ Switch into full bandwidth measurement mode, when activity interrupt is triggered
- ▶ Signal an interrupt to a microcontroller
- ▶ Wake-up downstream circuitry, depending on the configuration
- ▶ The response of the accelerometer is configurable via register settings
- ▶ Note that the time duration for the first wake-up data point may be up to 10 ms slower than subsequent data points. Wake-up mode is not supported in low noise (LN) mode.

Standby

Placing the ADXL367 in standby suspends measurement and reduces current consumption to 40 nA (typical). Pending interrupts and data are preserved and no new interrupts are generated.

The ADXL367 powers up in standby with all sensor functions turned off. Note that any changes to the registers before the POWER_CTL register (Register 0x00 to Register 0x2D) must be made with the device in standby. If changes are made while the ADXL367 is in measurement mode, they may be effective for only part of a measurement. Ensure the change of data capture configuration only occurs in standby mode.

THEORY OF OPERATION

SELECTABLE MEASUREMENT RANGES

The ADXL367 has selectable measurement ranges of $\pm 2 g$, $\pm 4 g$, and $\pm 8 g$. Acceleration samples are always converted by a 14-bit ADC. Therefore, sensitivity scales with g range. Ranges and corresponding sensitivity values are listed in. When the input exceeds the full-scale range, the output data may not be accurate temporarily. The sensor is not damaged as long as the acceleration remains below the absolute maximum rating. Table 5 lists the absolute maximum ratings for acceleration, indicating the acceleration level that can cause permanent damage to the device.

SELECTABLE OUTPUT DATA RATES

The ADXL367 can report acceleration data at various data rates ranging from 12.5 Hz to 400 Hz. The internal low-pass filter corner is automatically set to ensure the Nyquist sampling criterion is met and no aliasing occurs.

Current consumption varies somewhat with output data rate, as shown in Figure 43, remaining below 1.3 μA over the entire range of data rates and operating voltages.

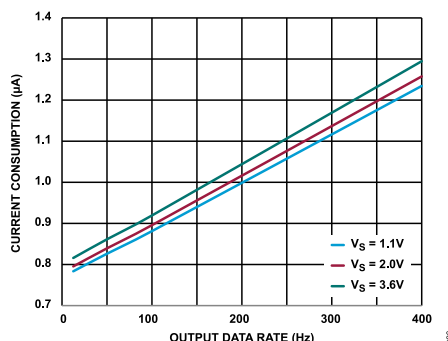

Figure 43. Current Consumption vs. Output Data Rate at Several Supply Voltages

Antialiasing

The ADC of the ADXL367 samples at the user selected output data rate. Without a proper antialias filter, input signals above half the data rate are aliased into the signal band. To mitigate this, a 2-pole low-pass filter is provided at the input of the ADC. The 2-pole filter is set to ODR/2 for optimum bandwidth and antialiasing for the user selected output data rate.

POWER/NOISE TRADEOFF

The ADXL367 offers two options for decreasing noise at the expense of only a small increase in current consumption.

The noise performance of the ADXL367 in normal operation, typically 11 LSB rms ($\pm 2 g$ mode) at 100 Hz ODR (50 Hz bandwidth), is adequate for most applications, depending on bandwidth and the desired resolution. For cases where lower noise is needed, the ADXL367 provides a lower noise operating mode that trades reduced noise for a somewhat higher current consumption.

Table 10 lists the current consumption and noise densities obtained for normal operation and low noise mode at a typical 2.0 V supply.

Table 10. Noise and Current Consumption: Normal Operation and Low Noise Mode at $V_S = 2.0 V$, ODR = 100 Hz

Mode	Noise ($\mu g/\sqrt{Hz}$) Typical	Current Consumption (μA) Typical
Normal Operation	370	0.89
Low Noise	200	1.77

TEMPERATURE SENSOR

The ADXL367 includes an integrated 14-bit temperature sensor, which the system designer can use to monitor internal system temperature or to improve the temperature stability of the device via calibration. For example, acceleration outputs vary with the temperature at a rate of $\pm 0.5 mg/^\circ C$ (typical), but the relationship of the outputs to temperature is repeatable and the designer can, therefore, use the temperature sensor output to calibrate the acceleration temperature drift.

The temperature sensor built in ADXL367 is trimmed at room temperature before shipping, so it can also be used to monitor the absolute temperature. To get even better accuracy, the user can measure and calibrate its initial bias at some known temperature in mass production.

To use the temperature sensor for calibration of the acceleration signal, it is sufficient to correlate acceleration to temperature sensor output, rather than to absolute temperature. In this case, it is not necessary to convert the temperature reading to an absolute temperature. Therefore, calibration of initial bias is not required.

The designer can configure the device to save data from the temperature sensor in the FIFO. Temperature samples, whether read from the output registers or from the FIFO, updates concurrently with acceleration (and ADC) samples unless it is turned off.

EXTERNAL ADC

In addition to a built-in accelerometer and temperature sensor, the ADXL367 incorporates a 14-bit ADC for digitization of an external analog input. The ADC is best suited for use with a sensor input due to its synchronization with the accelerometer and temperature sensor.

Use of the ADC adds approximately 50 nA to the total current consumption when operating at 100 Hz ODR. The ADXL367 enables the user to power down the ADC to save power when it is not needed.

Analog Inputs

The ADXL367 ADC can convert analog inputs ranging from 10% to 90% of the internally regulated voltage (V_{REG_OUT}) and the input range of the external ADC is limited to a maximum of 1 V by the internally regulated voltage.

THEORY OF OPERATION

Figure 44 shows an equivalent circuit of the input structure of the ADXL367. The two diodes, D1 and D2, provide ESD protection for the analog input (ADC_IN).

During the acquisition phase, the impedance of the analog input (ADC_IN) can be modeled by the series connection of input resistance (R_{IN}) and input capacitance (C_{IN}). R_{IN} is typically 20 k Ω and is a lumped component made up of some serial resistors and the on resistance of the switches. C_{IN} is typically 650 fF and is mainly the ADC sampling capacitor.

The acquisition time required is calculated using the following formula:

$$t_{ACQ} = 10 \times ((R_{SOURCE} + R_{IN}) C_{IN})$$

where R_{SOURCE} is the source impedance.

For 14-bit settling, t_{ACQ} must be less than 15 μ s. The acquisition time (t_{ACQ}) sets an upper limit on the source impedance (R_{SOURCE}) of approximately 2 M Ω . R_{IN} and C_{IN} make a one-pole, low-pass filter that reduces undesirable aliasing effects and limits the noise.

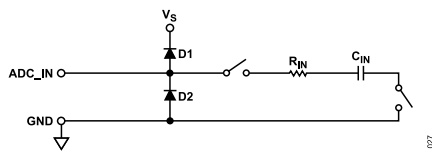

Figure 44. Equivalent Analog Input Circuit

POWER SAVINGS FEATURES

Designed for the most power conscious applications, the ADXL367 includes several features for enabling power savings at the system level, as well as at the device level.

ULTRALOW POWER CONSUMPTION IN ALL MODES

At the device level, the most obvious power saving feature of the ADXL367 is its ultralow current consumption in all configurations. The ADXL367 consumes between 0.8 μA (typical) and 1.4 μA (typical) across all data rates up to 400 Hz and all supply voltages up to 3.6 V (see [Figure 43](#)). At an even lower power of 160 nA (typical), a motion triggered wake-up mode is provided for simple motion detection applications that require a power consumption lower than 0.2 μA .

At these current levels, the accelerometer consumes less power in full operation than the standby currents of many other system components, and is, therefore, optimal for applications that require continuous acceleration monitoring and very long battery life. Because the accelerometer is always on, it can act as a motion activation switch. The accelerometer signals to the rest of the system when to turn on, thereby managing power at the system level.

As important as its low operating current, the 40 nA (typical) standby current of the ADXL367 contributes to a much longer battery life in applications that spend most of their time in a sleep state and wake-up via an external trigger.

EXTERNAL ADC INTERRUPT

The ADXL367 incorporates a 14-bit ADC for digitization of an external analog input. An interrupt can be generated based on a user set threshold of the external ADC. For the battery powered device, the external ADC can be used to monitor the supply voltage. After it is lower than the specified threshold, an interrupt can be generated to alert the end user to charge or change the battery. By using this function, the host processor does not need to use another ADC to check the power supply periodically.

MOTION DETECTION

The ADXL367 features built-in logic that detects activity (presence of acceleration greater than a threshold) and inactivity (lack of acceleration greater than a threshold). Activity and inactivity events can be used as triggers to manage the accelerometer mode of operation, trigger an interrupt to a host processor, and/or autonomously drive a motion switch.

Detection of an activity or inactivity event is indicated in the status register and can be configured to generate an interrupt. In addition, the activity status of the device, that is, whether it is moving or stationary, is indicated by the AWAKE bit, described in the [Using the AWAKE Bit](#) section.

Activity and inactivity detection can be used when the accelerometer is in either measurement mode or wake-up mode.

Activity Detection

An activity event is detected when acceleration remains greater than a specified threshold for a specified time period on any of the axes. If any axis exceeds the threshold, an activity event occurs (unless that axis is disabled).

Referenced and Absolute Configurations

Activity detection can be configured as referenced or absolute.

When using absolute activity detection, acceleration samples are compared to a user set threshold to determine whether motion is present. For example, if a threshold of 0.5 g is set and the acceleration on the z-axis is 1 g for longer than the user defined activity time, the activity status asserts.

In many applications, it is advantageous for activity detection to be based not on an absolute threshold, but on a deviation from a reference point or orientation. This is particularly useful because it removes the effect on activity detection of the static 1 g imposed by gravity. When an accelerometer is stationary, its output can reach 1 g, even when it is not moving. In absolute activity, when the threshold is set to less than 1 g, activity is immediately detected in this case.

The ADXL367 is in referenced configuration when one or both of the activity and inactivity enables are set to referenced mode (INACT_EN = 11 or ACT_EN = 11 in Register 0x27). In referenced configuration, activity is detected when acceleration samples are at least a user set amount greater than an internally defined reference for the user defined amount of time, as described in Equation 1.

$$\text{ABS}(\text{Acceleration} - \text{Reference}) > \text{Threshold} (1)$$

Consequently, activity is detected only when the acceleration has deviated sufficiently from the initial orientation. The reference for activity detection is calculated when activity detection is engaged in the following scenarios:

- ▶ When the activity function is turned on and measurement mode is engaged
- ▶ If link mode is enabled: when inactivity is detected and activity detection begins
- ▶ If link mode is not enabled: when activity is detected and activity detection repeats

The referenced configuration results in a very sensitive activity detection that detects even the most subtle motion events.

When using the referenced configuration, it is important to note that the device still uses the absolute thresholds when it first enters measurement mode. This becomes important if an inactivity threshold < 1 g is desired. In this case, the device must enter measurement mode with a threshold greater than 1 g. The inactivity threshold can then be lowered to the desired level (while still in measurement mode). This allows the device to set the thresholds around the 1 g offset on the z-axis.

POWER SAVINGS FEATURES

Fewer False Positives

Ideally, the intent of activity detection is to wake-up a system only when motion is intentional, ignoring noise or small, unintentional movements. In addition to being sensitive to subtle motion events, the ADXL367 activity detection algorithm is designed to be robust in filtering out undesired triggers.

The ADXL367 activity detection functionality includes a timer to filter out unwanted motion and ensure that only sustained motion is recognized as activity. The duration of this timer, as well as the acceleration threshold, are user adjustable from one sample (that is, no timer) to up to 20 seconds of motion.

Note that the activity timer is operational in measurement mode and wake-up mode. In wake-up mode, one sample activity detection is used.

Inactivity Detection

An inactivity event is detected when acceleration remains below a specified threshold for a specified time on all the axes. All three axes (if enabled) must be below the inactivity thresholds for an inactivity event to occur. Inactivity detection is also configurable as referenced or absolute.

When using absolute inactivity detection, acceleration samples are compared to a user set threshold for the user set time to determine the absence of motion. Inactivity is detected when enough consecutive samples are all below the threshold. The absolute configuration of inactivity must be used for implementing free fall detection.

When using referenced inactivity detection, inactivity is detected when acceleration samples are within a user specified amount of an internally defined reference (as described by Equation 2) for a user defined amount of time.

$$ABS(Acceleration - Reference) < Threshold(2)$$

The reference for inactivity detection is calculated when either of the following events occurs:

- ▶ The inactivity function is turned on and the device enters measurement mode
- ▶ An inactivity event is detected

Each time an inactivity event is detected, the reference is updated. This becomes important when using an inactivity timer. The reference is not updated until the timer expires. In dynamic environments, this can lead to the device becoming stuck in a state where it is looking for inactivity, but the acceleration is outside the threshold limits.

The following settings prove an example for enabling referenced inactivity, loop mode:

- ▶ 2 g, ODR = 100 Hz
- ▶ Referenced inactivity threshold = 250 mg
- ▶ Inactivity timer = 100 samples

- ▶ With the inactivity timer setting, this means that the device updates the inactivity reference once every second (because ODR is 100 Hz and the timer is 100 samples). This is shown in Figure 45.

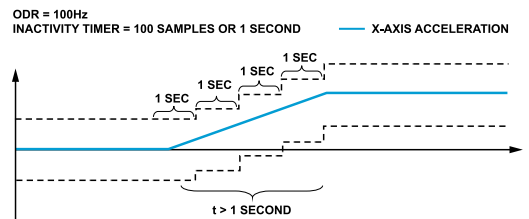

Figure 45. Referenced Inactivity Thresholds, Slow Change in Acceleration

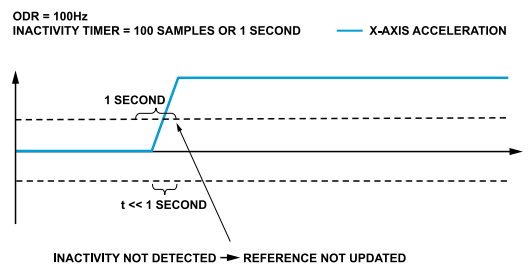

Figure 46. Referenced Inactivity Thresholds, Fast Change in Acceleration

In Figure 46, the acceleration exceeds the inactivity threshold before the time expires. This is an activity event. Therefore, inactivity is not detected. However, this now means that the reference thresholds are not updated. If the acceleration stays above the thresholds, the device is stuck in a loop of searching for inactivity but acceleration is outside of the limits. Even though the device may not be moving, inactivity is not detected.

Referenced inactivity, like referenced activity, is particularly useful for eliminating the effects of the static acceleration due to gravity. With absolute inactivity, if the inactivity threshold is set lower than 1 g, a device resting motionless may never detect inactivity. With referenced inactivity, the same device under the same configuration detects inactivity.

The inactivity timer can be set anywhere from 2.5 ms (a single sample at 400 Hz ODR) to almost 90 minutes (65,535 samples at 12.5 Hz ODR) of inactivity. A requirement for inactivity detection is that for whatever period of time the inactivity timer has been configured, the accelerometer detects inactivity only when it has been stationary for that amount of time.

For example, if the accelerometer has been configured for 90 minutes, the accelerometer detects inactivity when it has been stationary for 90 minutes. The wide range of timer settings means that in applications where power conservation is critical, the system can be put to sleep after very short periods of inactivity. In applications where continuous operation is critical, the system stays on for as long as any motion is present.

POWER SAVINGS FEATURES

Linking Activity and Inactivity Detection

The activity and inactivity detection functions can be used concurrently and processed manually by a host processor, or they can be configured to interact in several other ways, shown in the [Default Mode](#) section, [Linked Mode](#) section, [Loop Mode](#) section, and [Autosleep](#) section.

Default Mode

The user must enable the activity and inactivity functions because these functions are not automatically enabled by default. After the user enables the activity and inactivity functions, both activity and inactivity detection remain enabled and all interrupts must be serviced by a host processor, that is, a processor must read each interrupt before it is cleared and can be used again.

Default mode operation is shown in the flowchart in [Figure 47](#).

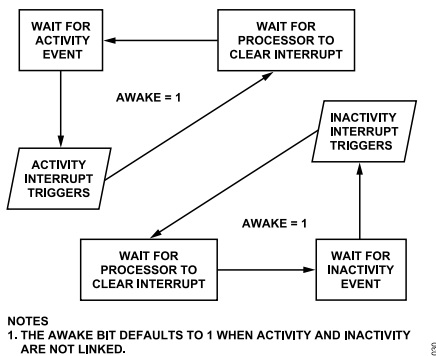

Figure 47. Flowchart Illustrating Activity and Inactivity Operation in Default Mode

Linked Mode

In linked mode, activity and inactivity detection are linked to each other in a way so that only one of the functions is enabled at any given time. As soon as activity is detected, the device is assumed to be moving (or awake) and stops looking for activity. Inactivity is expected as the next event. Therefore, only inactivity detection operates.

Similarly, when inactivity is detected, the device is assumed to be stationary (or asleep). Therefore, activity is expected as the next event and only activity detection operates.

In linked mode, activity interrupt is enabled first after power-up. Each interrupt must be serviced by a host processor before the next interrupt is enabled.

Please note that the AWAKE bit is defined as follows:

- ▶ On power-up, AWAKE = 1
- ▶ If inactivity is detected and inactivity interrupt is cleared, AWAKE = 0
- ▶ If activity is detected and activity interrupt is cleared, AWAKE = 1

It is important to note that in linked mode, the host processor must read the status register to update the activity and inactivity thresholds in referenced mode. Otherwise, the thresholds do not update as the acceleration changes.

Linked mode operation is shown in the flowchart in [Figure 48](#).

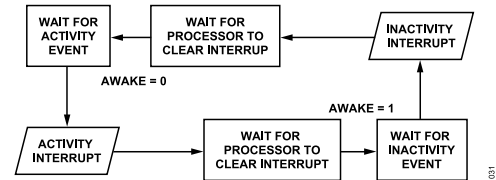

Figure 48. Flowchart Illustrating Activity and Inactivity Operation in Linked Mode

Loop Mode

In loop mode, motion detection operates as described in the [Linked Mode](#) section, but interrupts do not need to be serviced by a host processor. This configuration simplifies the implementation of commonly used motion detection and enhances power savings by reducing the amount of power used in bus communication.

Similar to linked mode, activity interrupt is enabled first after power-up in loop mode. Loop mode operation is shown in the flowchart in [Figure 49](#).

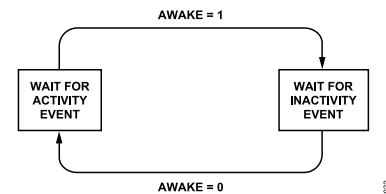

Figure 49. Flowchart Illustrating Activity and Inactivity Operation in Loop Mode

When using loop mode, it is important to note that the AWAKE bit is always asserted when the device first enters measurement mode. The device is currently waiting for an activity event. Therefore, this AWAKE bit remains asserted until activity is detected and an inactivity event is detected. To avoid this, the device must enter measurement mode with an activity threshold of 1 mg. The activity threshold can then be raised to the desired level (while still in measurement mode). This allows the device to deassert the AWAKE bit immediately after entering measurement mode.

Autosleep

When in linked mode or loop mode, enabling autosleep causes the device to enter wake-up mode autonomously (see the [Wake-Up Mode](#) section) when inactivity is detected while interrupt is serviced and to re-enter measurement mode when activity is detected and interrupt is serviced.

POWER SAVINGS FEATURES

The autosleep configuration is active only if linked mode or loop mode are enabled. In the default mode, the autosleep setting is ignored. Autosleep mode is not supported in low noise mode.

Using the AWAKE Bit

The AWAKE bit is a status bit that indicates whether the ADXL367 is awake or asleep. The device is awake when it has experienced an activity condition, and it is asleep when it has experienced an inactivity condition.

The awake signal can be mapped to the INT1 pin or INT2 pin, allowing the pin to serve as a status output to connect or disconnect power to downstream circuitry based on the awake status of the accelerometer. Used in conjunction with loop mode, this configuration implements a trivial, autonomous motion activated switch, as shown in [Figure 17](#).

This motion switch configuration can save significant system level power by eliminating the standby current consumption of the remainder of the application.

FIFO

The ADXL367 includes a deep 512-sample FIFO buffer. The FIFO provides benefits primarily in two ways, system level power savings and data recording/event context.

System Level Power Savings

Appropriate use of the FIFO enables system level power savings by enabling the host processor to sleep for extended periods of time while the accelerometer collects data. Alternatively, using the FIFO to collect data can unburden the host while it tends to other tasks.

Data Recording/Event Context

The FIFO can be used in a triggered mode to record all data leading up to an activity detection event, thereby providing context for the event. For example, in the case of a system that identifies impact events, the accelerometer can keep the entire system off while it stores acceleration data in its FIFO and looks for an activity event. When the impact event occurs, data that was collected prior to the event is frozen in the FIFO. The accelerometer can then wake the rest of the system and transfer this data to the host processor, thereby providing context for the impact event.

Generally, the more context that is available, the more intelligent decisions a system can achieve, making a deep FIFO especially useful. The ADXL367 FIFO can store up to more than 13 seconds of data, providing a clear picture of events prior to an activity trigger.

All FIFO modes of operation, as well as the structure of the FIFO and instructions for retrieving data from it, are described in further detail in the [FIFO Modes](#) section. Note that when retrieving data from FIFO, all axes of interest must be read in a burst (or multiple byte) read operation to avoid data loss or misalignment.

FIFO is not supported in wakeup and autosleep mode.

COMMUNICATIONS

SPI Instructions

The digital interface of the ADXL367 is implemented with system level power savings in mind. The following features enhance power savings:

- ▶ Burst reads and writes reduce the number of SPI communication cycles required to configure the device and retrieve data.
- ▶ Concurrent operation of activity and inactivity detection enables motion activated operation that requires minimal input from the processor. Loop mode further reduces communications power by enabling the clearing of interrupts without processor intervention.
- ▶ The FIFO is implemented in a way so that consecutive samples can be read continuously via a multibyte read of unlimited length. Therefore, one read FIFO instruction can clear the entire contents of the FIFO. In many other accelerometers, each read instruction retrieves a single sample only.

I2C Interface

The ADXL367 also offers an I²C interface for the platforms with limited GPIO resources. The ADXL367 conforms to the *UM10204 I²C-Bus Specification and User Manual*, Rev. 03—19 June 2007, available from NXP Semiconductor.

Bus Keepers

The ADXL367 includes bus keepers on the SCLK, INT1, and INT2 pins that may be configured as digital inputs. Bus keepers are used to prevent tristate bus lines from floating when nothing is driving them, preventing through current in any gate inputs that are on the bus.

MSB Registers

Acceleration and temperature measurements are converted to 14-bit values and transmitted via SPI or I²C using two registers per measurement. To read a full sample set of 3-axis acceleration data, six registers must be read.

Many applications do not require the accuracy that 14-bit data provides and prefer, instead, to save system level power. The MSB registers, XDATA, YDATA, and ZDATA, enable this tradeoff. These registers contain the eight MSBs of the x-axis, y-axis, and z-axis acceleration data. Reading them effectively provides 8-bit acceleration values. Importantly, only three (consecutive) registers must be read to retrieve a full data set, significantly reducing the time during which the SPI or I²C bus is active and drawing current.

14-bit, 12-bit, and 8-bit data are available simultaneously so that all data formats can be used in a single application, depending on the needs of the application at a given time. For example, the processor can read 14-bit data when higher resolution is required,

POWER SAVINGS FEATURES

and switch to 8-bit data (simply by reading a different set of registers) when application requirements change.

ADDITIONAL FEATURES

FREE FALL DETECTION

Many digital output accelerometers include a built-in free fall detection feature. In the ADXL367, this function can be implemented using the inactivity interrupt. Refer to the [Applications Information](#) section for more details, including suggested threshold and timing values.

TAP DETECTION

The tap interrupt function is capable of detecting either single or double taps. The following parameters are shown in [Figure 50](#) for a valid single and valid double tap event:

- ▶ The tap detection threshold is defined by the THRESH_TAP register. (Address 0x2F)
- ▶ The maximum tap duration time is defined by the TAP_DUR register. (Address 0x30)
- ▶ The tap latency time is defined by the TAP_LATENT register (Address 0x31) and is the waiting period from the end of the first tap until the start of the time window, when a second tap can be detected, which is determined by the value in the TAP_WINDOW register (Address 0x32).
- ▶ The interval after the latency time (set by the TAP_LATENT register) is defined by the window register. Although a second tap must begin after the latency time has expired, it does not have to finish before the end of the time defined by the TAP_WINDOW register.

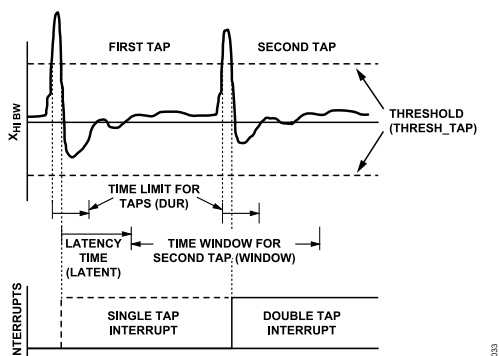

Figure 50. Tap Interrupt Function with Valid Single and Double Taps

If only the single tap function is in use, the single tap interrupt is triggered when the acceleration goes below the threshold, as long as the value of time stored in the TAP_DUR register has not been exceeded. If both single and double tap functions are in use, the single tap interrupt is triggered when the double tap event has been either validated or invalidated.

Note that when using a tap threshold (THRESH_TAP) less than 1 g, tilting the device may also result in a tap event.

EXTERNAL CLOCK

The ADXL367 has a built-in 102.4 kHz (typical) clock that, by default, serves as the time base for internal operations.

ODR and bandwidth scale proportionally with the clock. The ADXL367 provides a discrete number of options for ODR, such as 100 Hz, 50 Hz, and 25 Hz, in factors of 2. To achieve data rates other than those provided, an external clock can be used at the appropriate clock frequency. The output data rate scales with the clock frequency, as shown in Equation 3.

$$ODR_{ACTUAL} = ODR_{SELECTED} \times \frac{f}{102.4 \text{ kHz}} \quad (3)$$

For example, to achieve an 80 Hz ODR, select the 100 Hz ODR setting and provide a clock frequency that is 80% of nominal, or 81.92 kHz.

The ADXL367 can operate with external clock frequencies ranging from the nominal 102.4 kHz down to 51.2 kHz to allow the user to achieve any desired output data rate.

Alternatively, an external clock can be used to improve clock frequency accuracy. To achieve tighter tolerances, a more accurate clock can be provided externally.

Power consumption also scales with clock frequency. Higher clock rates increase power consumption. [Figure 51](#) shows how power consumption varies with clock rate.

Note that the external clock must only be configured when in stand-by mode and be running before the measurement mode command is issued.

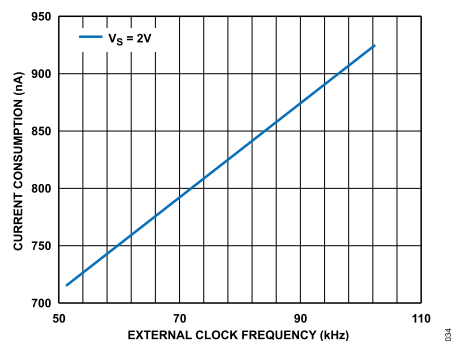

Figure 51. Current Consumption vs. External Clock Rate

EXTERNAL TRIGGER

For applications that require a precisely timed acceleration measurement, the ADXL367 features an option to synchronize acceleration sampling to an external trigger. Note that synchronized data sampling (external trigger) is not supported in the ADXL367 when in wake-up mode.

Refer to the [Using External Trigger](#) section for more information.

SELF TEST

The ADXL367 incorporates a self test feature that effectively tests its mechanical and electronic systems simultaneously. When the self test function is invoked, an electrostatic force is applied to the

ADDITIONAL FEATURES

mechanical sensor. This electrostatic force moves the mechanical sensing element in the same manner as acceleration, and it is additive to the acceleration experienced by the device. This added electrostatic force results in an output change only on x-axis channel. Any reading made on the y-axis channel and z-axis channel during self test is invalid.

USER REGISTER PROTECTION

The ADXL367 includes user register protection for single event upsets (SEUs). An SEU is a change of state caused by ions or electromagnetic radiation striking a sensitive node in a microelectronic device. The state change is a result of the free charge created by ionization in or close to an important node of a logic element (for example, a memory bit). The SEU, itself, is not considered permanently damaging to transistor or circuit functionality, but it can create erroneous register values. The ADXL367 registers that are protected from SEU are Register 0x00 to Register 0x43 with a 242 bit checker.

SEU protection is implemented via a 99-bit error correcting (Hamming-type) code that detects both single-bit and double-bit errors. The check bits are recomputed any time a write to any of the protected registers occurs. At any time, if the stored version of the check bits is not in agreement with the current check bit calculation, the ERR_USER_REGS status bit is set (Register 0x0B and Register 0x44).

The ERR_USER_REGS bit in the status registers (Register 0x0B and Register 0x44) is set on power-up prior to device configuration. It clears on the first register write to that device.

SERIAL COMMUNICATIONS

The ADXL367 communicates via a 4-wire SPI or I²C and operates as a slave. Ignore data that is transmitted from the ADXL367 to the master device during writes to the ADXL367.

As shown in [Figure 2](#) to [Figure 7](#), the MISO pin is in a high impedance state (held by a bus keeper) except when the ADXL367 is sending read data. This is done to conserve bus power.

Wire the ADXL367 for SPI communication, as shown in the connection diagram in [Figure 52](#). The recommended SPI clock speeds are 1 MHz to 8 MHz, with 12 pF maximum loading.

The ADXL367 uses an SPI mode with a clock polarity (CPOL) of zero and a clock phase (CPHA) of zero.

For correct operation of the device, the logic thresholds and timing parameters in [Table 2](#) and [Table 3](#) must be met at all times. Refer to [Figure 11](#) and [Figure 12](#) for visual diagrams of the timing parameters.

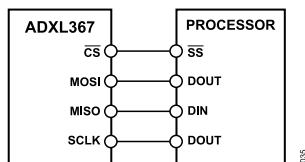

Figure 52. 4-Wire SPI Connection Diagram

SPI COMMANDS

The SPI port uses a multibyte structure where the first byte is a command. The ADXL367 command set is as follows:

- ▶ 0x0A: write register
- ▶ 0x0B: read register
- ▶ 0x0D: read FIFO

Read and Write Register Commands

The command structure for the read register and write register commands is **</CS down> <command byte (0x0A or 0x0B)> <address byte> <data byte> <additional data bytes for multi-byte> ... </CS up>**

The read and write register commands support multibyte (burst) read/write access. The waveform diagrams for multibyte read and write commands are shown in [Figure 2](#) and [Figure 3](#).

Read FIFO Command

Reading from the FIFO buffer is a command structure that does not have an address, **</CS down> <command byte (0x0D)> <data byte> <data byte> ... </CS up>**.

It is recommended that a full sample set be read (using a multibyte transaction). If a full sample set is not read using a multibyte transaction, FIFO can get discarded and the channel ID can slip out of synchronization. Data is presented most significant byte first, followed by the least significant byte.

MULTIBYTE TRANSFERS

Multibyte transfers, also known as burst transfers, are supported for all SPI commands (register read, register write, and FIFO read commands). It is recommended that data be read using multibyte transfers to ensure that a concurrent and complete set of x-axis, y-axis, and z-axis acceleration (and temperature, where applicable) data is read.

The FIFO runs on the serial port clock during FIFO reads and can sustain bursting at the SPI clock rate as long as the SPI clock is fast enough to pop data faster than it is being written to the FIFO (depends on ODR).

Register Read/Write Auto-Increment

A register read or write command begins with the address specified in the command and auto-increments for each additional byte in the transfer. Register 0x00 to Register 0x45 are user accessible. A multibyte register read that extends past Register 0x45 gives valid data only up to Register 0x45. Any attempt to read a higher register may result in invalid data.

INVALID ADDRESSES AND ADDRESS ALIASING

The ADXL367 has a 7-bit address bus, mapping only 128 registers in the possible 256 register address space. Address 0x00 to Address 0x45 are for customer access, as described in [Table 11](#). Address 0x46 to Address 0x7F are reserved for factory use. Any attempt to read beyond Register 0x7F results in invalid data.

LATENCY RESTRICTIONS

Reading any of the data registers (Address 0x08 to Address 0x0A or Address 0x0E to Address 0x17) clears the data ready interrupt. There can be as much as a 120 μ s delay from reading a register to the clearing of the data ready interrupt. This delay can increase to 420 μ s in wake-up mode.

Other register reads, register writes, and FIFO reads have no latency restrictions.

INVALID COMMANDS

There are only three valid SPI commands for the ADXL367, 0x0A, 0x0B, and 0x0D. All other commands are invalid and must be avoided. When not receiving a valid command, the MISO output remains in a high impedance state, and the bus keeper holds the MISO line at its last value.

SPI BUS SHARING

When using the ADXL367 on the same SPI bus as another sensor, additional protection may be needed to maintain ultralow noise performance. This is especially important if the other devices use an SPI clock of 15 MHz or greater. Use a gated buffer on the SCLK line for the ADXL367 device. This gated SCLK allows the clock signal through only when the chip select (CS) line is low.

SERIAL COMMUNICATIONS

See Figure 53 for the example circuit that provides this type of protection.

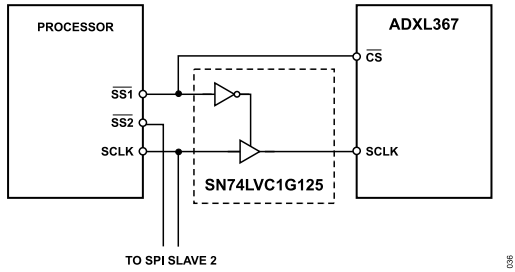

Figure 53. SCLK Protection Example

I²C

With SCLK tied low to ground, the ADXL367 is in I²C mode, requiring a 2-wire connection, as shown in I²C Connection Diagram. The ADXL367 conforms to the *UM10204 I²C-Bus Specification and User Manual*, Rev. 03—19 June 2007, available from NXP Semiconductor. The ADXL367 meets this standard with the exception that it does not support dynamic switching into high speed mode. It supports standard (100 kHz) and fast (400 kHz) data transfer modes if the bus parameters given in Table 4 are met.

With the ASEL pin high, the 7-bit I²C address for the device is 0x53, followed by the R/W bit, as shown in Figure 48. This translates to 0xA6 for a write and 0xA7 for a read. An alternate I²C address of 0x1D (followed by the R/W bit) can be chosen by grounding the ASEL pin. This translates to 0x3A for a write and 0x3B for a read.

Single-byte or multiple-byte reads/writes are supported, as shown in Figure 55. More detailed FIFO read protocol information is described in Figure 13.

There are no internal pull-up or pull-down resistors for any unused pins. Therefore, there is no known state or default state for the ASEL pin if it is left floating or unconnected. It is required that the ASEL pin be connected to either V_{DDIO} or ground when using I²C.

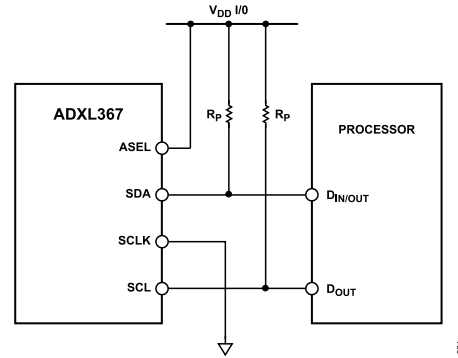
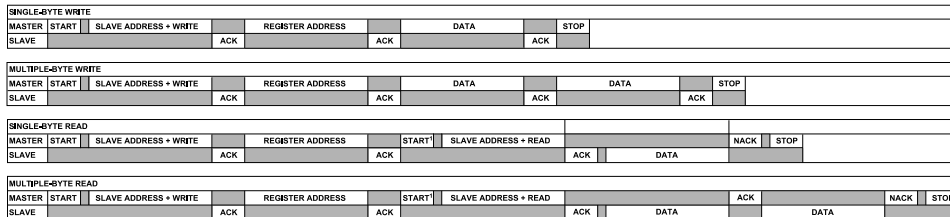

Figure 54. I²C Connection Diagram (Address 0x53)

If other devices are connected to the same I²C bus, the nominal operating voltage level of these other devices cannot exceed V_{DDIO} by more than 0.3 V. External pull-up resistors (R_P) are necessary for proper I²C operation. Refer to the *UM10204 I²C-Bus Specification and User Manual*, Rev. 03—19 June 2007, when selecting pull-up resistor values to ensure proper operation.



NOTES
 1. THIS START IS EITHER A RESTART OR A STOP FOLLOWED BY A START.
 2. THE SHADED AREAS REPRESENT WHEN THE DEVICE IS LISTENING.

Figure 55. I²C Device Addressing (Read from Data Registers)

REGISTER MAP

Table 11. Register Map

Register	Name	Bits	Bit 7	Bit 6	Bit 5	Bit 4	Bit 3	Bit 2	Bit 1	Bit 0	Reset	R/W	
0x00	DEVID_AD	[7:0]	DEVID_AD									0xAD	R
0x01	DEVID_MST	[7:0]	DEVID_MST									0x1D	R
0x02	PART_ID	[7:0]	PART_ID									0xF7	R
0x03	REV_ID	[7:0]	REV_ID									0x03	R
0x04	SERIAL_NUMBER_3	[7:0]	RESERVED				SERIAL_NUMBER[27:24]				0x00	R	
0x05	SERIAL_NUMBER_2	[7:0]	SERIAL_NUMBER[23:16]									0x00	R
0x06	SERIAL_NUMBER_1	[7:0]	SERIAL_NUMBER[15:8]									0x00	R
0x07	SERIAL_NUMBER_0	[7:0]	SERIAL_NUMBER[7:0]									0x00	R
0x08	XDATA	[7:0]	XDATA_H									0x00	R
0x09	YDATA	[7:0]	YDATA_H									0x00	R
0x0A	ZDATA	[7:0]	ZDATA_H									0x00	R
0x0B	STATUS	[7:0]	ERR_US ER_RE GS	AWAKE	INACT	ACT	FIFO_OVER RUN	FIFO_WATER _MARK	FIFO_REA DY	DATA_RE ADY	0x40	R	
0x0C	FIFO_ENTRIES_L	[7:0]	FIFO_ENTRIES[7:0]									0x00	R
0x0D	FIFO_ENTRIES_H	[7:0]	RESERVED						FIFO_ENTRIES[9:8]			0x00	R
0x0E	XDATA_H	[7:0]	XDATA[13:6]									0x00	R
0x0F	XDATA_L	[7:0]	XDATA[5:0]						RESERVED			0x00	R
0x10	YDATA_H	[7:0]	YDATA[13:6]									0x00	R
0x11	YDATA_L	[7:0]	YDATA[5:0]						RESERVED			0x00	R
0x12	ZDATA_H	[7:0]	ZDATA[13:6]									0x00	R
0x13	ZDATA_L	[7:0]	ZDATA[5:0]						RESERVED			0x00	R
0x14	TEMP_H	[7:0]	TEMP_DATA[13:6]									0x00	R
0x15	TEMP_L	[7:0]	TEMP_DATA[5:0]						RESERVED			0x00	R
0x16	EX_ADC_H	[7:0]	EX_ADC_DATA[13:6]									0x00	R
0x17	EX_ADC_L	[7:0]	EX_ADC_DATA[5:0]						RESERVED			0x00	R
0x18	I2C_FIFO_DATA	[7:0]	I2C_FIFO_DATA									0x00	R
0x1F	SOFT_RESET	[7:0]	RESERVED						SOFT_RE SET	RESERVE D	0x52	W	
0x20	THRESH_ACT_H	[7:0]	RESER VED	THRESH_ACT[12:6]								0x00	R/W
0x21	THRESH_ACT_L	[7:0]	THRESH_ACT[5:0]						RESERVED			0x00	R/W
0x22	TIME_ACT	[7:0]	TIME_ACT									0x00	R/W
0x23	THRESH_INACT_H	[7:0]	RESER VED	THRESH_INACT[12:6]								0x00	R/W
0x24	THRESH_INACT_L	[7:0]	THRESH_INACT[5:0]						RESERVED			0x00	R/W
0x25	TIME_INACT_H	[7:0]	TIME_INACT[15:8]									0x00	R/W
0x26	TIME_INACT_L	[7:0]	TIME_INACT[7:0]									0x00	R/W
0x27	ACT_INACT_CTL	[7:0]	RESERVED		LINKLOOP		INACT_EN		ACT_EN			0x00	R/W
0x28	FIFO_CONTROL	[7:0]	RESER VED	CHANNEL_SELECT				FIFO_SAMPL ES[8]	FIFO_MODE			0x00	R/W

REGISTER MAP

Table 11. Register Map

Register	Name	Bits	Bit 7	Bit 6	Bit 5	Bit 4	Bit 3	Bit 2	Bit 1	Bit 0	Reset	R/W	
0x29	FIFO_SAMPLES	[7:0]	FIFO_SAMPLES[7:0]									0x80	R/W
0x2A	INTMAP1_LOWER	[7:0]	INT_LOW_INT1	AWAKE_INT1	INACT_INT1	ACT_INT1	FIFO_OVERRUN_INT1	FIFO_WATERMARK_INT1	FIFO_RDY_INT1	DATA_RDY_INT1	0x00	R/W	
0x2B	INTMAP2_LOWER	[7:0]	INT_LOW_INT2	AWAKE_INT2	INACT_INT2	ACT_INT2	FIFO_OVERRUN_INT2	FIFO_WATERMARK_INT2	FIFO_RDY_INT2	DATA_RDY_INT2	0x00	R/W	
0x2C	FILTER_CTL	[7:0]	RANGE		I2C_HS	RESERVED	EXT_SAMPLER	ODR			0x23	R/W	
0x2D	POWER_CTL	[7:0]	RESERVED	EXT_CLK	NOISE		WAKEUP	AUTOSLEEP	MEASURE		0x00	R/W	
0x2E	SELF_TEST	[7:0]	RESERVED						ST_FORCE	ST	0x00	R/W	
0x2F	TAP_THRESH	[7:0]	TAP_THRESH_PRESCALE									0x00	R/W
0x30	TAP_DUR	[7:0]	TAP_DUR									0x00	R/W
0x31	TAP_LATENT	[7:0]	TAP_LATENT									0x00	R/W
0x32	TAP_WINDOW	[7:0]	TAP_WINDOW									0x00	R/W
0x33	X_OFFSET	[7:0]	RESERVED			X_USER_OFFSET			0x00			R/W	
0x34	Y_OFFSET	[7:0]	RESERVED			Y_USER_OFFSET			0x00			R/W	
0x35	Z_OFFSET	[7:0]	RESERVED			Z_USER_OFFSET			0x00			R/W	
0x36	X_SENS	[7:0]	RESERVED			X_USER_SENS			0x00			R/W	
0x37	Y_SENS	[7:0]	RESERVED			Y_USER_SENS			0x00			R/W	
0x38	Z_SENS	[7:0]	RESERVED			Z_USER_SENS			0x00			R/W	
0x39	TIMER_CTL	[7:0]	WAKEUP_RATE		RESERVED	TIMER_KEEP_ALIVE					0x00	R/W	
0x3A	INTMAP1_UPPER	[7:0]	ERR_FUSE_INT1	ERR_USER_REGS_INT1	RESERVED	KPALV_TIMER_INT1	TEMP_ADC_HI_INT1	TEMP_ADC_LOW_INT1	TAP_TWO_INT1	TAP_ONE_INT1	0x00	R/W	
0x3B	INTMAP2_UPPER	[7:0]	ERR_FUSE_INT2	ERR_USER_REGS_INT2	RESERVED	KPALV_TIMER_INT2	TEMP_ADC_HI_INT2	TEMP_ADC_LOW_INT2	TAP_TWO_INT2	TAP_ONE_INT2	0x00	R/W	
0x3C	ADC_CTL	[7:0]	FIFO_8_12BIT		RESERVED	RESERVED	ADC_INACT_EN	RESERVED	ADC_ACT_EN	ADC_EN	0xC0	R/W	
0x3D	TEMP_CTL	[7:0]	RESERVED				TEMP_INACT_EN	RESERVED	TEMP_ACT_EN	TEMP_EN	0x00	R/W	
0x3E	TEMP_ADC_OVER_THRSH_H	[7:0]	RESERVED	TEMP_ADC_THRESH_HIGH[12:6]							0x00	R/W	
0x3F	TEMP_ADC_OVER_THRSH_L	[7:0]	TEMP_ADC_THRESH_HIGH[5:0]						RESERVED			0x00	R/W
0x40	TEMP_ADC_UNDER_THRSH_H	[7:0]	RESERVED	TEMP_ADC_THRESH_LOW[12:6]							0x00	R/W	
0x41	TEMP_ADC_UNDER_THRSH_L	[7:0]	TEMP_ADC_THRESH_LOW[5:0]						RESERVED			0x00	R/W
0x42	TEMP_ADC_TIMER	[7:0]	TIMER_TEMP_ADC_INACT				TIMER_TEMP_ADC_ACT				0x00	R/W	
0x43	AXIS_MASK	[7:0]	RESERVED		TAP_AXIS		RESERVED	ACT_INACT_Z	ACT_INACT_Y	ACT_INACT_X	0x00	R/W	
0x44	STATUS_COPY	[7:0]	ERR_USER_REGS	AWAKE	INACT	ACT	FIFO_OVER_RUN	FIFO_WATERMARK	FIFO_READY	DATA_READY	0x40	R	
0x45	STATUS_2	[7:0]	ERR_FUSE_REGS	FUSE_REFRESH	RESERVED	TIMER	TEMP_ADC_HI	TEMP_ADC_LOW	TAP_TWO	TAP_ONE	0x00	R	

REGISTER DETAILS

This section describes the functions of the ADXL367 registers. The ADXL367 powers up with the default register values shown in Table 13.

Note that any changes to the registers before the POWER_CTL register (Register 0x00 to Register 0x2C) must be made with the

device in standby. If changes are made while the ADXL367 is in measurement mode, they may be effective for only part of a measurement.

ADI DEVICE ID REGISTER

Address: 0x00, Reset: 0xAD, Name: DEVID_AD

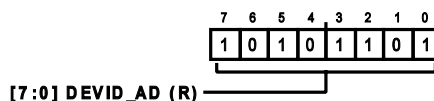

Table 12. Bit Descriptions for DEVID_AD

Bits	Bit Name	Settings	Description	Reset	Access
[7:0]	DEVID_AD		This register contains the Analog Devices device ID	0xAD	R

MEMS DEVICE ID REGISTER

Address: 0x01, Reset: 0x1D, Name: DEVID_MST

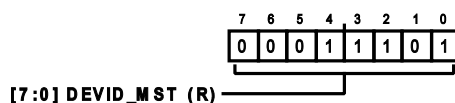

Table 13. Bit Descriptions for DEVID_MST

Bits	Bit Name	Settings	Description	Reset	Access
[7:0]	DEVID_MST		This register contains the Analog Devices MEMS device ID	0x1D	R

PART ID REGISTER

Address: 0x02, Reset: 0xF7, Name: PART_ID

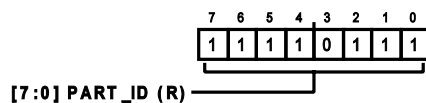

Table 14. Bit Descriptions for PART_ID

Bits	Bit Name	Settings	Description	Reset	Access
[7:0]	PART_ID		This register contains the device ID	0xF7	R

REVISION ID REGISTER

Address: 0x03, Reset: 0x03, Name: REV_ID

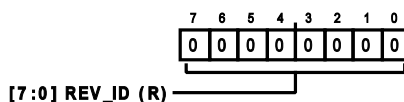

Table 15. Bit Descriptions for REV_ID

Bits	Bit Name	Settings	Description	Reset	Access
[7:0]	REV_ID		This register contains the product revision ID	0x03	R

XID REGISTERS

Address: 0x04, Reset: 0x00, Name: SERIAL_NUMBER_3

REGISTER DETAILS

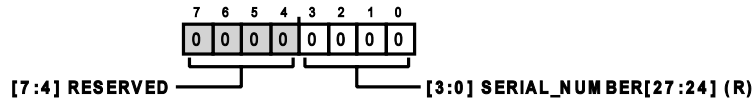

Table 16. Bit Descriptions for SERIAL_NUMBER_3

Bits	Bit Name	Settings	Description	Reset	Access
[7:4]	RESERVED		Reserved.	0x0	R
[3:0]	SERIAL_NUMBER[27:24]		This register contains the 31-bit product serial number	0x0	R

Address: 0x05, Reset: 0x00, Name: SERIAL_NUMBER_2



Table 17. Bit Descriptions for SERIAL_NUMBER_2

Bits	Bit Name	Settings	Description	Reset	Access
[7:0]	SERIAL_NUMBER[23:16]		This register contains the 31-bit product serial number	0x0	R

Address: 0x06, Reset: 0x00, Name: SERIAL_NUMBER_1



Table 18. Bit Descriptions for SERIAL_NUMBER_1

Bits	Bit Name	Settings	Description	Reset	Access
[7:0]	SERIAL_NUMBER[15:8]		This register contains the 31-bit product serial number	0x0	R

Address: 0x07, Reset: 0x00, Name: SERIAL_NUMBER_0

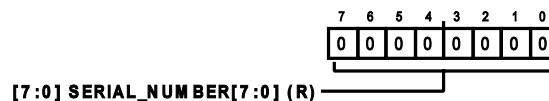

Table 19. Bit Descriptions for SERIAL_NUMBER_0

Bits	Bit Name	Settings	Description	Reset	Access
[7:0]	SERIAL_NUMBER[7:0]		This register contains the 31-bit product serial number	0x0	R

X-DATA BITS[13:6] REGISTER

Address: 0x08, Reset: 0x00, Name: XDATA

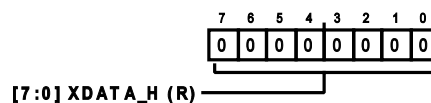

Table 20. Bit Descriptions for XDATA

Bits	Bit Name	Settings	Description	Reset	Access
[7:0]	XDATA_H		This register holds the eight most significant bits of the x-axis acceleration data. This limited resolution data register is used in power conscious applications where eight bits of data are sufficient: energy can be conserved by reading only one byte of data per axis, rather than two.	0x0	R

REGISTER DETAILS

Y-DATA BITS[13:6] REGISTER

Address: 0x09, Reset: 0x00, Name: YDATA

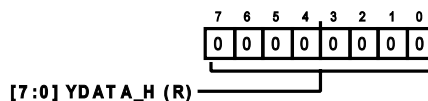

Table 21. Bit Descriptions for YDATA

Bits	Bit Name	Settings	Description	Reset	Access
[7:0]	YDATA_H		This register holds the eight most significant bits of the y-axis acceleration data. This limited resolution data register is used in power conscious applications where eight bits of data are sufficient: energy can be conserved by reading only one byte of data per axis, rather than two.	0x0	R

Z-DATA BITS[13:6] REGISTER

Address: 0x0A, Reset: 0x00, Name: ZDATA

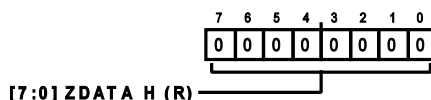

Table 22. Bit Descriptions for ZDATA

Bits	Bit Name	Settings	Description	Reset	Access
[7:0]	ZDATA_H		This register holds the eight most significant bits of the z-axis acceleration data. This limited resolution data register is used in power conscious applications where eight bits of data are sufficient: energy can be conserved by reading only one byte of data per axis, rather than two.	0x0	R

STATUS REGISTER

Address: 0x0B, Reset: 0x40, Name: STATUS

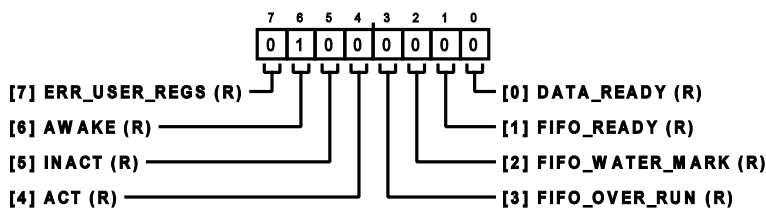

Table 23. Bit Descriptions for STATUS

Bits	Bit Name	Description	Reset	Access
7	ERR_USER_REGS	SEU Error Detect. A 1 indicates one of two conditions: either an SEU event, such as an alpha particle or a power glitch, has disturbed a user register setting or the ADXL367 is not configured. This bit is high on both startup and soft reset, and resets as soon as any register write commands are performed.	0x0	R
6	AWAKE	Indicates whether the accelerometer is in an active (AWAKE = 1) or inactive (AWAKE = 0) state, based on the activity and inactivity functionality. To enable autosleep, activity and inactivity detection must be in linked mode or loop mode (LINKLOOP bits in the ACT_INACT_CTL register). Otherwise, this bit defaults to 1 and must be ignored. 0: device is inactive. 1: device is active (reset state).	0x1	R
5	INACT	Inactivity. A 1 indicates that the inactivity detection function has detected an inactivity or a free fall condition.	0x0	R
4	ACT	Activity. A 1 indicates that the activity detection function has detected an overthreshold condition.	0x0	R

REGISTER DETAILS

Table 23. Bit Descriptions for STATUS

Bits	Bit Name	Description	Reset	Access
3	FIFO_OVER_RUN	FIFO Overrun. A 1 indicates that the FIFO has overrun or overflowed. No new data is written to the FIFO until a FIFO read has occurred to free up some space for new data. FIFO_OVER_RUN is only available in FIFO_MODE = oldest saved mode.	0x0	R
2	FIFO_WATER_MARK	FIFO Watermark. A 1 indicates that the FIFO contains at least the desired number of samples, as set in the FIFO_SAMPLES register. FIFO_WATER_MARK is asserted when the next sample (greater than the value) is written to the FIFO.	0x0	R
1	FIFO_READY	FIFO Ready. A 1 indicates that there is at least one sample available in the FIFO output buffer.	0x0	R
0	DATA_READY	Data Ready. A 1 indicates that a new valid sample is available to be read. This bit clears when a DATA read is performed. DATA_READY is set when new valid data is available, it is cleared when no new data is available. The DATA_READY bit is not set while any of the data registers, Address 0x08 to Address 0x0A and Address 0x0E to Address 0x17, are being read. If DATA_READY = 0 prior to a register read and new data becomes available during the register read, DATA_READY remains at 0 until the read is complete and, only then, is set to 1. If DATA_READY = 1 prior to a register read, it is cleared at the start of the register read. If DATA_READY = 1 prior to a register read and new data becomes available during the register read, DATA_READY is cleared to 0 at the start of the register read and remains at 0 throughout the read. When the read is complete, DATA_READY is set to 1.	0x0	R

FIFO ENTRIES BITS[7:0] REGISTER

Address: 0x0C, Reset: 0x00, Name: FIFO_ENTRIES_L

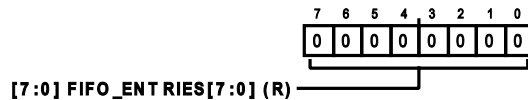

Table 24. Bit Descriptions for FIFO_ENTRIES_L

Bits	Bit Name	Settings	Description	Reset	Access
[7:0]	FIFO_ENTRIES[7:0]		These registers indicate the number of valid data samples present in the FIFO buffer. This number ranges from 0 to 512 or 0x00 to 0x200. FIFO_ENTRIES_L contains the least significant byte. FIFO_ENTRIES_H contains the two most significant bits. Bits[15:10] of FIFO_ENTRIES_H are unused (represented as X = don't care)	0x0	R

FIFO ENTRIES BITS[9:8] REGISTER

Address: 0x0D, Reset: 0x00, Name: FIFO_ENTRIES_H

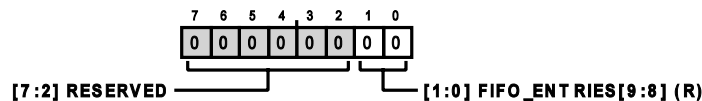
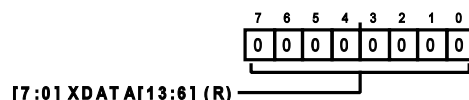

Table 25. Bit Descriptions for FIFO_ENTRIES_H

Bits	Bit Name	Settings	Description	Reset	Access
[7:2]	RESERVED		Reserved.	0x0	R
[1:0]	FIFO_ENTRIES[9:8]		These registers indicate the number of valid data samples present in the FIFO buffer. This number ranges from 0 to 512 or 0x00 to 0x200. FIFO_ENTRIES_L contains the least significant byte. FIFO_ENTRIES_H contains the two most significant bits. Bits[15:10] of FIFO_ENTRIES_H are unused (represented as X = don't care)	0x0	R

X-DATA BITS[13:6] REGISTER

Address: 0x0E, Reset: 0x00, Name: XDATA_H



REGISTER DETAILS

Table 26. Bit Descriptions for XDATA_H

Bits	Bit Name	Settings	Description	Reset	Access
[7:0]	XDATA[13:6]		These two registers contain the sign extended (X) x-axis acceleration data. XDATA_H contains the eight most significant bits (MSBs), and XDATA_L contains the six least significant bits (LSBs) of the 14-bit value. Note that Register 0x0F must always be read immediately after this register to clear data ready. If 8-bit data is desired, read Register 0x08.	0x0	R

X-DATA BITS[5:0] REGISTER

Address: 0x0F, Reset: 0x00, Name: XDATA_L

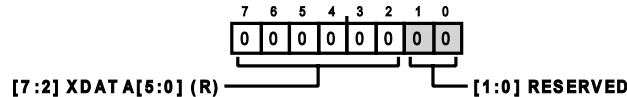

Table 27. Bit Descriptions for XDATA_L

Bits	Bit Name	Settings	Description	Reset	Access
[7:2]	XDATA[5:0]		These two registers contain the sign extended (X) x-axis acceleration data. XDATA_H contains the eight MSBs, and XDATA_L contains the six LSBs of the 14-bit value.	0x0	R
[1:0]	RESERVED		Reserved.	0x0	R

Y-DATA BITS[13:6] REGISTER

Address: 0x10, Reset: 0x00, Name: YDATA_H

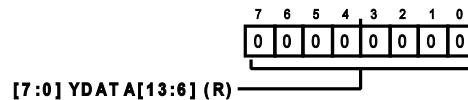

Table 28. Bit Descriptions for YDATA_H

Bits	Bit Name	Settings	Description	Reset	Access
[7:0]	YDATA[13:6]		These two registers contain the sign extended (Y) y-axis acceleration data. YDATA_H contains the eight MSBs, and YDATA_L contains the six LSBs of the 14-bit value. Note that Register 0x11 must always be read immediately after this register to clear data ready. If 8-bit data is desired, read Register 0x09.	0x0	R

Y-DATA BITS[5:0] REGISTER

Address: 0x11, Reset: 0x00, Name: YDATA_L

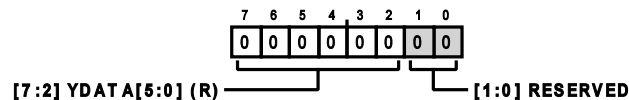

Table 29. Bit Descriptions for YDATA_L

Bits	Bit Name	Settings	Description	Reset	Access
[7:2]	YDATA[5:0]		These two registers contain the sign extended (Y) y-axis acceleration data. YDATA_H contains the eight MSBs, and YDATA_L contains the six LSBs of the 14-bit value.	0x0	R
[1:0]	RESERVED		Reserved.	0x0	R

Z-DATA BITS[13:6] REGISTER

Address: 0x12, Reset: 0x00, Name: ZDATA_H

REGISTER DETAILS

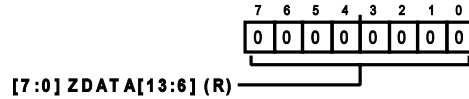

Table 30. Bit Descriptions for ZDATA_H

Bits	Bit Name	Settings	Description	Reset	Access
[7:0]	ZDATA[13:6]		These two registers contain the sign extended (Z) z-axis acceleration data. ZDATA_H contains the eight MSBs, and ZDATA_L contains the six LSBs of the 14-bit value. Note that Register 0x13 must always be read immediately after this register to clear data ready. If 8-bit data is desired, read Register 0x0A.	0x0	R

Z-DATA BITS[5:0] REGISTER

Address: 0x13, Reset: 0x00, Name: ZDATA_L

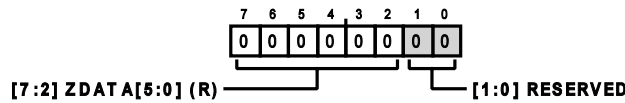

Table 31. Bit Descriptions for ZDATA_L

Bits	Bit Name	Settings	Description	Reset	Access
[7:2]	ZDATA[5:0]		These two registers contain the sign extended (Z) z-axis acceleration data. ZDATA_H contains the eight MSBs, and ZDATA_L contains the six LSBs of the 14-bit value.	0x0	R
[1:0]	RESERVED		Reserved.	0x0	R

TEMPERATE DATA BITS[13:6] REGISTER

Address: 0x14, Reset: 0x00, Name: TEMP_H

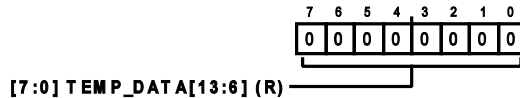

Table 32. Bit Descriptions for TEMP_H

Bits	Bit Name	Settings	Description	Reset	Access
[7:0]	TEMP_DATA[13:6]		These two registers contain the sign extended (T) temperate data. TEMP_H contains the eight MSBs, and TEMP_L contains the six LSBs of the 14-bit value.	0x0	R

TEMPERATE DATA BITS[5:0] REGISTER

Address: 0x15, Reset: 0x00, Name: TEMP_L

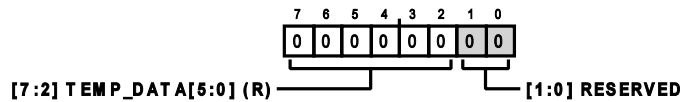

Table 33. Bit Descriptions for TEMP_L

Bits	Bit Name	Settings	Description	Reset	Access
[7:2]	TEMP_DATA[5:0]		These two registers contain the sign extended (T) temperate data. TEMP_H contains the eight MSBs, and TEMP_L contains the six LSBs of the 14-bit value.	0x0	R
[1:0]	RESERVED		Reserved.	0x0	R

ADC DATA BITS[13:6] REGISTER

Address: 0x16, Reset: 0x00, Name: EX_ADC_H

REGISTER DETAILS

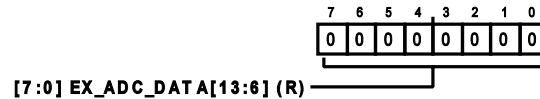

Table 34. Bit Descriptions for EX_ADC_H

Bits	Bit Name	Settings	Description	Reset	Access
[7:0]	EX_ADC_DATA[13:6]		These two registers contain the sign extended (ADC) external connected input ADC data. EX_ADC_H contains the eight MSBs, and EX_ADC_L contains the six LSBs of the 14-bit value.	0x0	R

ADC DATA BITS[5:0] REGISTER

Address: 0x17, Reset: 0x00, Name: EX_ADC_L

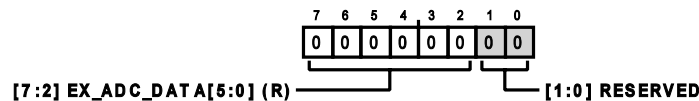

Table 35. Bit Descriptions for EX_ADC_L

Bits	Bit Name	Settings	Description	Reset	Access
[7:2]	EX_ADC_DATA[5:0]		These two registers contain the sign extended (ADC) external connected input ADC data. EX_ADC_H contains the eight MSBs, and EX_ADC_L contains the six LSBs of the 14-bit value.	0x0	R
[1:0]	RESERVED		Reserved.	0x0	R

I²C FIFO DATA REGISTER

Address: 0x18, Reset: 0x00, Name: I2C_FIFO_DATA

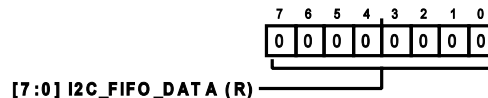

Table 36. Bit Descriptions for I2C_FIFO_DATA

Bits	Bit Name	Settings	Description	Reset	Access
[7:0]	I2C_FIFO_DATA		I ² C FIFO Data Read Address. A read to this address pops an effective words of axis data from the FIFO. Two subsequent reads or a multibyte read completes the transaction of this data onto the interface. Continued reading or a sustained multibyte read of this field continues to pop the FIFO. Multibyte reads to this address do not increment the address pointer. If this address is read due to an auto-increment from the previous address, it does not pop the FIFO. Instead, it skips over this address.	0x0	R

SOFT RESET REGISTER

Address: 0x1F, Reset: 0x52, Name: SOFT_RESET

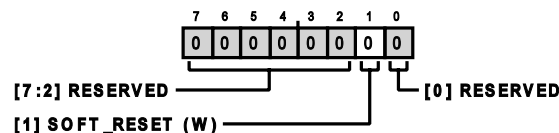

Table 37. Bit Descriptions for SOFT_RESET

Bits	Bit Name	Settings	Description	Reset	Access
[7:2]	RESERVED		Reserved.	0x14	R
1	SOFT_RESET		Writing code 0x52 (representing the letter R in ASCII or unicode) to this register immediately resets the ADXL367. All register settings are cleared, and the sensor is placed in standby. Interrupt pins	0x1	W

REGISTER DETAILS

Table 37. Bit Descriptions for *SOFT_RESET*

Bits	Bit Name	Settings	Description	Reset	Access
0	RESERVED		are configured to a high output impedance mode and held to a valid state by bus keepers when not being internally driven. This is a write-only register. If read, data in it is always 0x00. A latency of approximately 0.5 ms is required after soft reset.	0x0	R

THRESHOLD ACTIVITY BITS[12:6] REGISTER

Address: 0x20, Reset: 0x00, Name: THRESH_ACT_H

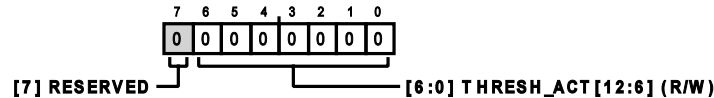
Table 38. Bit Descriptions for *THRESH_ACT_H*

Bits	Bit Name	Settings	Description	Reset	Access
7	RESERVED		Reserved.	0x0	R
[6:0]	THRESH_ACT[12:6]		To detect activity, the ADXL367 compares the absolute value of the 14-bit (signed) acceleration data with the 13-bit (unsigned) THRESH_ACT value. See the Motion Detection section for more information on activity detection. The term, THRESH_ACT, refers to an 13-bit unsigned value comprised of the THRESH_ACT_L register, which holds its six LSBs (THRESH_ACT[5:0]), and the THRESH_ACT_H register, which holds its seven MSBs (THRESH_ACT[12:6]). THRESH_ACT is set in codes. The value in <i>g</i> depends on the measurement range setting that is selected.	0x0	R/W

THRESHOLD ACTIVITY BITS[5:0] REGISTER

Address: 0x21, Reset: 0x00, Name: THRESH_ACT_L

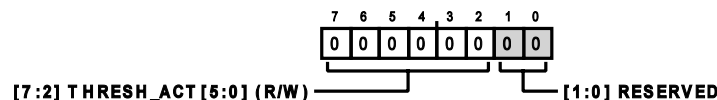
Table 39. Bit Descriptions for *THRESH_ACT_L*

Bits	Bit Name	Settings	Description	Reset	Access
[7:2]	THRESH_ACT[5:0]		To detect activity, the ADXL367 compares the absolute value of the 14-bit (signed) acceleration data with the 13-bit (unsigned) THRESH_ACT value. See the Motion Detection section for more information on activity detection. The term, THRESH_ACT, refers to a 13-bit unsigned value comprised of the THRESH_ACT_L register, which holds its six LSBs (THRESH_ACT[5:0]), and the THRESH_ACT_H register, which holds its seven MSBs (THRESH_ACT[12:6]). THRESH_ACT is set in codes. The value in <i>g</i> depends on the measurement range setting that is selected.	0x0	R/W
[1:0]	RESERVED		Reserved.	0x0	R

TIMED ACTIVITY REGISTER

Address: 0x22, Reset: 0x00, Name: TIME_ACT

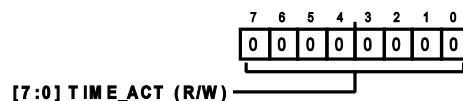
Table 40. Bit Descriptions for *TIME_ACT*

Bits	Bit Name	Settings	Description	Reset	Access
[7:0]	TIME_ACT		The activity timer implements a robust activity detection that minimizes false positive motion triggers. When the timer is used, only sustained motion can trigger activity detection. Refer to the Fewer False	0x0	R/W

REGISTER DETAILS

Table 40. Bit Descriptions for TIME_ACT

Bits	Bit Name	Settings	Description	Reset	Access
			Positives section for additional information. The value in this register sets the number of consecutive samples that must have at least one axis greater than the activity threshold (set by THRESH_ACT) for an activity event to be detected.		

THRESHOLD INACTIVITY BITS[12:6] REGISTER

Address: 0x23, Reset: 0x00, Name: THRESH_INACT_H

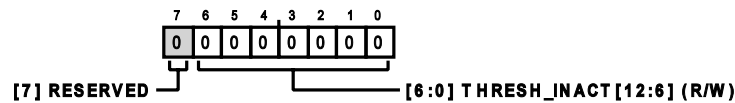

Table 41. Bit Descriptions for THRESH_INACT_H

Bits	Bit Name	Settings	Description	Reset	Access
7	RESERVED		Reserved.	0x0	R
[6:0]	THRESH_INACT[12:6]		To detect inactivity, the absolute value of the 14-bit acceleration data is compared with the 13-bit (unsigned) THRESH_INACT value, inactivity = acceleration < acceleration. See the Motion Detection section for more information. The term, THRESH_INACT, refers to a 13-bit unsigned value comprised of the THRESH_INACT_L registers, which holds its six LSBs (THRESH_INACT[5:0]) and the THRESH_INACT_H register, which holds its seven MSBs (THRESH_INACT[12:6]).	0x0	R/W

THRESHOLD INACTIVITY BITS[5:0] REGISTER

Address: 0x24, Reset: 0x00, Name: THRESH_INACT_L

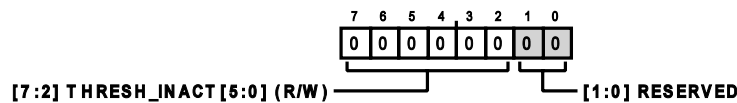

Table 42. Bit Descriptions for THRESH_INACT_L

Bits	Bit Name	Settings	Description	Reset	Access
[7:2]	THRESH_INACT[5:0]		To detect inactivity, the absolute value of the 14-bit acceleration data is compared with the 13-bit (unsigned) THRESH_INACT value, inactivity = acceleration < acceleration. See the Motion Detection section for more information. The term, THRESH_INACT, refers to a 13-bit unsigned value comprised of the THRESH_INACT_L register, which holds its six LSBs (THRESH_INACT[5:0]) and the THRESH_INACT_H register, which holds its seven MSBs (THRESH_INACT[12:6]).	0x0	R/W
[1:0]	RESERVED		Reserved.	0x0	R

TIMED INACTIVITY BITS[15:8] REGISTER

Address: 0x25, Reset: 0x00, Name: TIME_INACT_H



Table 43. Bit Descriptions for TIME_INACT_H

Bits	Bit Name	Settings	Description	Reset	Access
[7:0]	TIME_INACT[15:8]		The 16-bit value in these registers sets the number of consecutive samples that must have all axes lower than the inactivity threshold (set by THRESH_INACT) for an inactivity event to be detected.	0x0	R/W

REGISTER DETAILS

TIMED INACTIVITY BITS[7:0] REGISTER

Address: 0x26, Reset: 0x00, Name: TIME_INACT_L

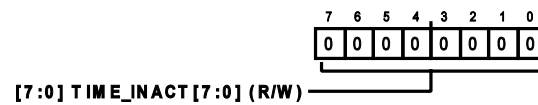

Table 44. Bit Descriptions for TIME_INACT_L

Bits	Bit Name	Settings	Description	Reset	Access
[7:0]	TIME_INACT[7:0]		The 16-bit value in these registers sets the number of consecutive samples that must have all axes lower than the inactivity threshold (set by THRESH_INACT) for an inactivity event to be detected.	0x0	R/W

ACTIVITY INACTIVITY CONTROL REGISTER

Address: 0x27, Reset: 0x00, Name: ACT_INACT_CTL

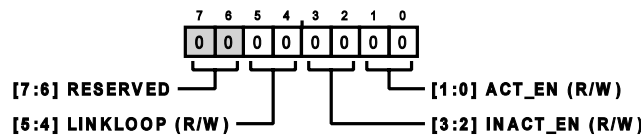

Table 45. Bit Descriptions for ACT_INACT_CTL

Bits	Bit Name	Description	Reset	Access
[7:6]	RESERVED	Reserved.	0x0	R
[5:4]	LINKLOOP	Enable and configuration settings for linking or looping detection modes as well as host microcontroller interrupt handling. 00: activity and inactivity detection are both enabled, and their interrupts (if mapped) must be acknowledged by the host processor by reading the STATUS register. Autosleep is disabled in this mode. Use this mode for free fall detection applications. Activity on temperature or ADC is only supported in this mode. 01: activity and inactivity detection are linked sequentially so that only one is enabled at a time. Their interrupts (if mapped) must be acknowledged by the host processor by reading the STATUS register. This setting only affects x-channel, y-channel, and z-channel configuration, it has no effect on temperature or ADC. 10: activity and inactivity detection are both enabled, and their interrupts (if mapped) must be acknowledged by the host processor by reading the STATUS register. Autosleep is disabled in this mode. Use this mode for free fall detection applications. Activity on temperature or ADC is only supported in this mode. 11: activity and inactivity detection are linked sequentially so that only one is enabled at a time, and their interrupts are internally acknowledged (do not need to be serviced by the host processor). To use either linked or looped mode, both ACT_EN (Bits[1:0]) and INACT_EN (Bits[3:2]) must be set to 1. Otherwise, the default mode is used. For additional information, refer to the Linking Activity and Inactivity Detection section. This setting only effects x-channel, y-channel, and z-channel configuration, it has no effect on temperature or ADC.	0x0	R/W
[3:2]	INACT_EN	Referenced or Absolute (Default) Inactivity Mode Enable. 00: no inactivity detection enabled. 01: inactivity enable. 10: no inactivity detection enabled. 11: Referenced inactivity enable.	0x0	R/W
[1:0]	ACT_EN	Activity Enable. 00: no activity detection. 01: activity enable. 10: no activity detection. 11: referenced activity enable.	0x0	R/W

FIFO CONTROL REGISTER

Address: 0x28, Reset: 0x00, Name: FIFO_CONTROL

REGISTER DETAILS

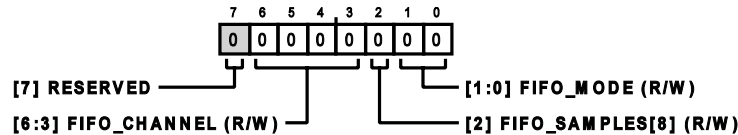

Table 46. Bit Descriptions for FIFO_CONTROL

Bits	Bit Name	Description	Reset	Access
7	RESERVED	Reserved.	0x0	R/W
[6:3]	FIFO_CHANNEL	<p>Enables Selectable Axis Conversions.</p> <p>0000: converts all three axis (x, y, z). This is the default mode.</p> <p>0001: only x-axis data is converted.</p> <p>0010: only y-axis data stored in the FIFO. See the ADC Control Register section and the Temperature Configuration Register section to see if anything else is stored in the FIFO.</p> <p>0011: only x-axis data is converted.</p> <p>0100: x-axis, y-axis, and z-axis data along with temperature is converted. The TEMP_EN bit (Register 0x3D) must be set to enable the temperature measurement.</p> <p>0101: x-axis data along with temperature is converted. The TEMP_EN bit must be set to enable the temperature measurement.</p> <p>0110: y-axis data along with temperature is converted. The TEMP_EN bit must be set to enable the temperature measurement.</p> <p>0111: z-axis data along with temperature is converted. The TEMP_EN bit must be set to enable the temperature measurement.</p> <p>1000: x-axis, y-axis, and z-axis data along with the external ADC is converted. The ADC_EN bit (Register 0x3C) must be set to enable the external ADC measurement.</p> <p>1001: x-axis data along with the external ADC is converted. The ADC_EN bit must be set to enable the external ADC measurement.</p> <p>1010: y-axis data along with the external ADC is converted. The ADC_EN bit must be set to enable the external ADC measurement.</p> <p>1011: z-axis data along with the external ADC is converted. The ADC_EN bit must be set to enable the external ADC measurement.</p> <p>1100: Do not use this setting.</p> <p>1101: Do not use this setting.</p> <p>1110: Do not use this setting.</p> <p>1111: Do not use this setting.</p>	0x0	R/W
2	FIFO_SAMPLES[8]	The value in this register specifies the number of samples set to store in the FIFO. If the x-axis, y-axis, and z-axis are configured to be stored in the FIFO and a value of 2 is written to the FIFO samples, 6 samples are written into the FIFO. The full range of FIFO samples is 0 to 511. The default value of this register is 0x80 to avoid triggering the FIFO watermark interrupt.	0x0	R/W
[1:0]	FIFO_MODE	<p>FIFO Mode Settings. Any changes to this setting must be made in standby mode only. To change from one mode to another, it is strongly recommended to go to mode = 00 (FIFO disabled) between modes to ensure no partial resets or samples occur.</p> <p>00: FIFO disabled.</p> <p>01: in oldest saved mode, the FIFO accumulates data until it is full and then stops. Additional data is collected only when space is made available by reading samples out of the FIFO buffer (this mode of operation is sometimes referred to as first N).</p> <p>10: in stream mode, the FIFO always contains the most recent data. The oldest sample is discarded when space is needed to make room for a newer sample (this mode of operation is sometimes referred to as last N). Stream mode is useful for unburdening a host processor. The processor can tend to other tasks while data is being collected in the FIFO. When the FIFO fills to a certain number of samples (specified by the FIFO_SAMPLES register along with the FIFO_SAMPLES_MSB bit in the FIFO_CTL register), it triggers a FIFO watermark interrupt (if this interrupt is enabled). At this point, the host processor can read the contents of the entire FIFO and then return to its other tasks as the FIFO fills again.</p>	0x0	R/W

REGISTER DETAILS

Table 46. Bit Descriptions for FIFO_CONTROL

Bits	Bit Name	Description	Reset	Access
		11: in triggered mode, the FIFO saves samples surrounding an activity event. The operation is similar to a one time run trigger on an oscilloscope. The number of samples to be saved prior to the activity event is specified in FIFO_SAMPLES register, along with the FIFO_SAMPLES[8] bit in this FIFO_CONTROL register. When an activity event triggers the FIFO to start filling, the desired number of samples are stored, and the FIFO_WATER_MARK interrupt is activated (if mapped to an interrupt pin), a FIFO read must be taken before another interrupt can be activated.		

FIFO SAMPLE REGISTER

Address: 0x29, Reset: 0x80, Name: FIFO_SAMPLES



Table 47. Bit Descriptions for FIFO_SAMPLES

Bits	Bit Name	Settings	Description	Reset	Access
[7:0]	FIFO_SAMPLES[7:0]		The value in this register specifies the number of samples sets to store in the FIFO. If the x-axis, y-axis, and z-axis are configured to be stored in the FIFO and a value of 2 is written to the FIFO samples, then 6 samples are written into the FIFO. The full range of FIFO samples is 0 to 511. The default value of this register is 0x80 to avoid triggering the FIFO watermark interrupt.	0x80	R/W

INTERRUPT PIN 1 ENABLES (LOWER) REGISTER

Address: 0x2A, Reset: 0x00, Name: INTMAP1_LOWER

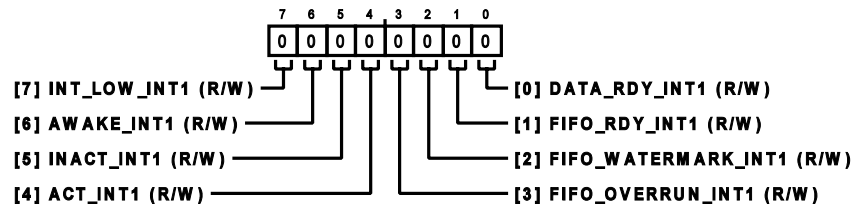

Table 48. Bit Descriptions for INTMAP1_LOWER

Bits	Bit Name	Description	Reset	Access
7	INT_LOW_INT1	Configures whether the pin operates in active high (Bit 7 low) or active low (Bit 7 high) mode. 1: interrupt enabled. 0: interrupt disabled.	0x0	R/W
6	AWAKE_INT1	1 = maps the awake status to the INT1 pin. 1: interrupt enabled. 0: interrupt disabled.	0x0	R/W
5	INACT_INT1	1 = maps the inactivity status to the INT1 pin. 1: interrupt enabled. 0: interrupt disabled.	0x0	R/W
4	ACT_INT1	Enable the activity detected interrupt to the INT1 pin. 1: interrupt enabled. 0: interrupt disabled.	0x0	R/W
3	FIFO_OVERRUN_INT1	1 = maps the FIFO overrun status to the INT1 pin. 1: interrupt enabled. 0: interrupt disabled.	0x0	R/W
2	FIFO_WATERMARK_INT1	1 = maps the FIFO watermark status to the INT1 pin.	0x0	R/W

REGISTER DETAILS

Table 48. Bit Descriptions for INTMAP1_LOWER

Bits	Bit Name	Description	Reset	Access
		1: interrupt enabled. 0: interrupt disabled.		
1	FIFO_RDY_INT1	1 = maps the FIFO ready status to the INT1 pin. 1: interrupt enabled. 0: interrupt disabled.	0x0	R/W
0	DATA_RDY_INT1	Set to 1 to map the DATA_READY bit (Register 0x0B and Register 0x44) to the INT1 pin. 1: interrupt enabled. 0: interrupt disabled.	0x0	R/W

INTERRUPT PIN 2 ENABLES (LOWER) REGISTER

Address: 0x2B, Reset: 0x00, Name: INTMAP2_LOWER

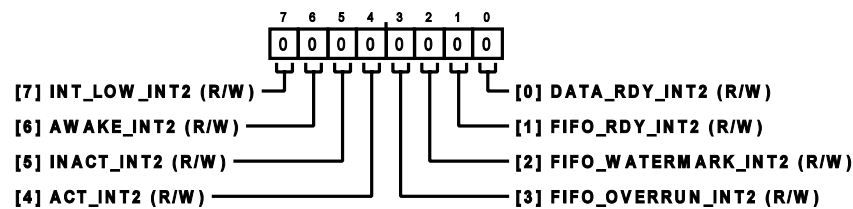

Table 49. Bit Descriptions for INTMAP2_LOWER

Bits	Bit Name	Description	Reset	Access
7	INT_LOW_INT2	Configures whether the pin operates in active high (Bit 7 low) or active low (Bit 7 high) mode. 1: interrupt enabled. 0: interrupt disabled.	0x0	R/W
6	AWAKE_INT2	Set to 1 to map awake mode to the INT2 pin. 1: interrupt enabled. 0: interrupt disabled.	0x0	R/W
5	INACT_INT2	Set to 1 to map the inactivity status to the INT1 pin. 1: interrupt enabled. 0: interrupt disabled.	0x0	R/W
4	ACT_INT2	Enable activity detected interrupt to the INT2 pin. 1: interrupt enabled. 0: interrupt disabled.	0x0	R/W
3	FIFO_OVERRUN_INT2	Set to 1 to map the FIFO overrun status to the INT1 pin. 1: interrupt enabled. 0: interrupt disabled.	0x0	R/W
2	FIFO_WATERMARK_INT2	Set to 1 to map the FIFO_WATER_MARK bit (Register 0x0B and Register 0x44) to the INT2 pin. 1: interrupt enabled. 0: interrupt disabled.	0x0	R/W
1	FIFO_RDY_INT2	Set to 1 to map the FIFO ready status to the INT1 pin. 1: interrupt enabled. 0: interrupt disabled.	0x0	R/W
0	DATA_RDY_INT2	Set to 1 to map the DATA_READY bit (Register 0x0B and Register 0x44) to the INT2 pin. 1: interrupt enabled. 0: interrupt disabled.	0x0	R/W

REGISTER DETAILS

FILTER CONTROL REGISTER

Address: 0x2C, Reset: 0x23, Name: FILTER_CTL

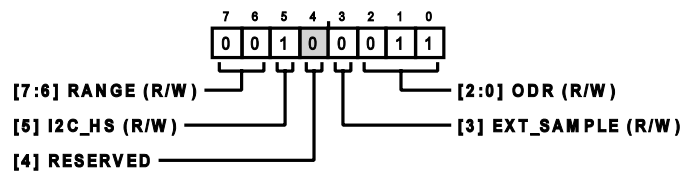

Table 50. Bit Descriptions for FILTER_CTL

Bits	Bit Name	Description	Reset	Access
[7:6]	RANGE	00: $\pm 2 g$ (reset default). 01: $\pm 4 g$. 10: $\pm 8 g$. 11: reserved.	0x0	R/W
5	I2C_HS	High Speed I ² C Mode. Default is on and its only recommended to change this bit from 1 to 0 (in standby mode). A soft reset or POR must be used to switch back to high speed mode. The ADXL367 does not comply with one of the I ² C specifications (the 00001XXX command for switching from standard mode to high speed mode is not recognized).	0x1	R/W
4	RESERVED	Reserved.	0x0	R
3	EXT_SAMPLE	External Sampling Trigger. 1 = the INT2 pin is used for external conversion timing control. Refer to the Using External Trigger section for more information.	0x0	R/W
[2:0]	ODR	Sets output data and configures internal filter to ODR/2. 000: 12.5 Hz ODR. 001: 25 Hz ODR. 010: 50 Hz ODR. 011: 100 Hz ODR. 100: 200 Hz ODR. 101: 400 Hz ODR.	0x3	R/W

POWER CONTROL REGISTER

Address: 0x2D, Reset: 0x00, Name: POWER_CTL

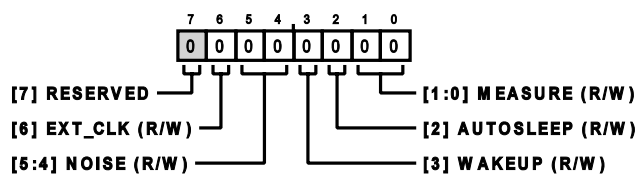

Table 51. Bit Descriptions for POWER_CTL

Bits	Bit Name	Description	Reset	Access
7	RESERVED	Reserved.	0x0	R
6	EXT_CLK	External Clock. See the Using an External Clock section for additional details.	0x0	R/W
[5:4]	NOISE	Noise Mode Configuration. 00: normal operation low power operation mode (reset default). 01: low noise mode (see the Power/Noise Tradeoff section for more information). 10: ultralow noise mode (see the Power/Noise Tradeoff section for more information). 11: reserved	0x0	R/W
3	WAKEUP	Wake-Up Mode. See the Operating Modes section for a detailed description of wake-up mode.	0x0	R/W

REGISTER DETAILS

Table 51. Bit Descriptions for POWER_CTL

Bits	Bit Name	Description	Reset	Access
2	AUTOSLEEP	Autosleep. Activity and inactivity detection must be in linked mode or loop mode (LINKLOOP bits in ACT_INACT_CTL register) to enable autosleep. Otherwise, the bit is ignored. See the Motion Detection section for details.	0x0	R/W
[1:0]	MEASURE	Configures device into standby or measurement operating mode. 00: standby mode. 01: reserved. 10: measurement mode. 11: reserved.	0x0	R/W

USER SELF TEST REGISTER

Address: 0x2E, Reset: 0x00, Name: SELF_TEST

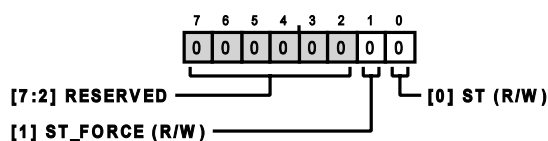

Table 52. Bit Descriptions for SELF_TEST

Bits	Bit Name	Description	Reset	Access
[7:2]	RESERVED	Reserved.	0x0	R
1	ST_FORCE	Force Self Test.	0x0	R/W
0	ST	Self Test.	0x0	R/W

TAP THRESHOLD REGISTER

Address: 0x2F, Reset: 0x00, Name: TAP_THRESH



Table 53. Bit Descriptions for TAP_THRESH

Bits	Bit Name	Settings	Description	Reset	Access
[7:0]	TAP_THRESH_PRESCALE		The TAP_THRESH_PRESCALE register is eight bits and holds the threshold value for tap interrupts. The data format is unsigned. Therefore, the magnitude of the tap event is compared with the value in TAP_THRESH for normal tap detection. The scale factor is 62.5 mg/LSB (that is, 0xFF = 16 g). A value of 0 disables both tap and double tap detection.	0x0	R/W

TAP DURATION REGISTER

Address: 0x30, Reset: 0x00, Name: TAP_DUR

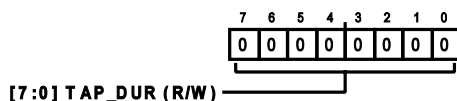

Table 54. Bit Descriptions for TAP_DUR

Bits	Bit Name	Settings	Description	Reset	Access
[7:0]	TAP_DUR		The TAP_DUR register is 8 bits and contains an unsigned time value representing the maximum time that an event must be above the TAP_THRESH threshold to qualify as a tap event. The scale factor is 625 μs/LSB.	0x0	R/W

REGISTER DETAILS

TAP LATENCY REGISTER

Address: 0x31, Reset: 0x00, Name: TAP_LATENT

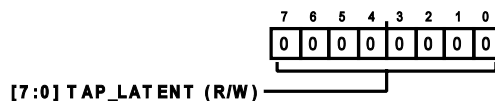

Table 55. Bit Descriptions for TAP_LATENT

Bits	Bit Name	Settings	Description	Reset	Access
[7:0]	TAP_LATENT		The TAP_LATENT register is 8 bits and contains an unsigned time value representing the wait time from the detection of a tap event to the start of the time window (defined by the tap window register), during which a possible second tap event can be detected. The scale factor is 1.25 ms/LSB. A value of 0 disables the double tap function.	0x0	R/W

TAP WINDOW REGISTER

Address: 0x32, Reset: 0x00, Name: TAP_WINDOW

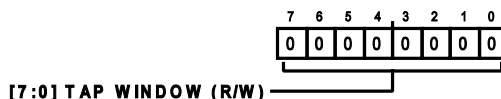

Table 56. Bit Descriptions for TAP_WINDOW

Bits	Bit Name	Settings	Description	Reset	Access
[7:0]	TAP_WINDOW		The TAP_WINDOW register is 8 bits and contains an unsigned time value representing the amount of time after the expiration of the latency time (determined by the latent register) during which a second valid second tap (double tap) must occur to be considered a valid double tap. The scale factor is 1.25 ms/LSB.	0x0	R/W

X-AXIS USER OFFSET REGISTER

Address: 0x33, Reset: 0x00, Name: X_OFFSET

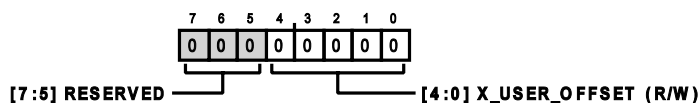

Table 57. Bit Descriptions for X_OFFSET

Bits	Bit Name	Settings	Description	Reset	Access
[7:5]	RESERVED		Reserved.	0x0	R
[4:0]	X_USER_OFFSET		User X-Axis Offset Calibration, Using a 15 mg/LSB Scale Factor. This is in a twos complement format where Bit 4 is the sign bit. This can be used to shift the offset of the device. Note that this trim setting shares the same headroom as the factory trim setting. In other words, a device with a high offset may have less room available for the user to trim.	0x0	R/W

Y-AXIS USER OFFSET REGISTER

Address: 0x34, Reset: 0x00, Name: Y_OFFSET

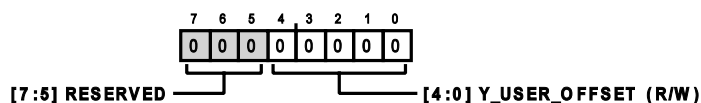

Table 58. Bit Descriptions for Y_OFFSET

Bits	Bit Name	Settings	Description	Reset	Access
[7:5]	RESERVED		Reserved.	0x0	R

REGISTER DETAILS

Table 58. Bit Descriptions for Y_OFFSET

Bits	Bit Name	Settings	Description	Reset	Access
[4:0]	Y_USER_OFFSET		User Y-Axis Offset Calibration, Using a 15 mg/LSB Scale Factor. This is in a twos complement format where Bit 4 is the sign bit. This can be used to shift the offset of the device. Note that this trim setting shares the same headroom as the factory trim setting. In other words, a device with a high offset may have less room available for the user to trim.	0x0	R/W

Z-AXIS USER OFFSET REGISTER

Address: 0x35, Reset: 0x00, Name: Z_OFFSET

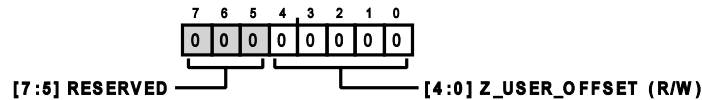

Table 59. Bit Descriptions for Z_OFFSET

Bits	Bit Name	Settings	Description	Reset	Access
[7:5]	RESERVED		Reserved.	0x0	R
[4:0]	Z_USER_OFFSET		User Z-Axis Offset Calibration, Using a 15 mg/LSB Scale Factor. This is in a twos complement format where Bit 4 is the sign bit. This can be used to shift the offset of the device. Note that this trim setting shares the same headroom as the factory trim setting. In other words, a device with a high offset may have less room available for the user to trim.	0x0	R/W

X-AXIS USER SENSITIVITY REGISTER

Address: 0x36, Reset: 0x00, Name: X_SENS

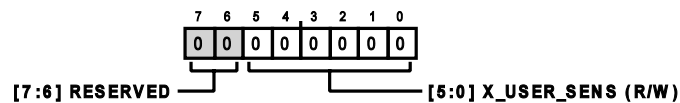

Table 60. Bit Descriptions for X_SENS

Bits	Bit Name	Settings	Description	Reset	Access
[7:6]	RESERVED		Reserved.	0x0	R
[5:0]	X_USER_SENS		User X-Axis Gain Calibration, Using a 1.56%/LSB Scale Factor. This is in a twos complement format where Bit 5 is the sign bit. This can be used to adjust the sensitivity of the device. Note that this trim setting shares the same headroom as the factory trim setting. In other words, a device with a high sensitivity may have less room available for the user to trim.	0x0	R/W

Y-AXIS USER SENSITIVITY REGISTER

Address: 0x37, Reset: 0x00, Name: Y_SENS

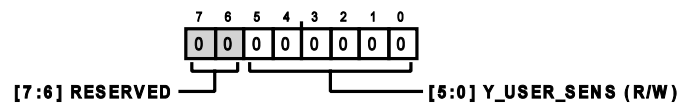

Table 61. Bit Descriptions for Y_SENS

Bits	Bit Name	Settings	Description	Reset	Access
[7:6]	RESERVED		Reserved.	0x0	R
[5:0]	Y_USER_SENS		User Y-axis Gain Calibration, Using a 1.56%/LSB Scale Factor. This is in a twos complement format where Bit 5 is the sign bit. This can be used to adjust the sensitivity of the device. Note that this trim setting shares the same headroom as the factory trim setting. In other words, a part with a high sensitivity may have less room available for the user to trim.	0x0	R/W

REGISTER DETAILS

Z-AXIS USER SENSITIVITY REGISTER

Address: 0x38, Reset: 0x00, Name: Z_SENS

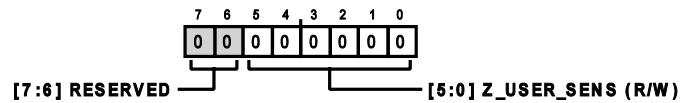

Table 62. Bit Descriptions for Z_SENS

Bits	Bit Name	Settings	Description	Reset	Access
[7:6]	RESERVED		Reserved.	0x0	R
[5:0]	Z_USER_SENS		User Z-Axis Gain Calibration, Using a 1.56%/LSB Scale Factor. This is in a twos complement format where Bit 5 is the sign bit. This can be used to adjust the sensitivity of the device. Note that this trim setting shares the same headroom as the factory trim setting. In other words, a device with a high sensitivity may have less room available for the user to trim.	0x0	R/W

TIMER CONTROL REGISTER

Address: 0x39, Reset: 0x00, Name: TIMER_CTL

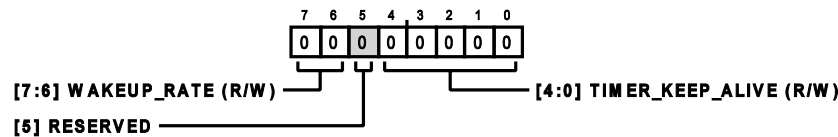

Table 63. Bit Descriptions for TIMER_CTL

Bits	Bit Name	Description	Reset	Access
[7:6]	WAKEUP_RATE	Indicates when the wake-up ADXL367 timer expires. 00: 12 samples per second. 80 ms between samples (reset default). 01: 6 samples per second. 160 ms between samples. 10: 3 samples per second. 320 ms between samples. 11: 1.5 samples per second. 640 ms between samples.	0x0	R/W
5	RESERVED	Reserved.	0x0	R/W
[4:0]	TIMER_KEEP_ALIVE	When the timer expires, Bit 4 of the STATUS2 register is set, and a read of STATUS2 clears this bit. This status is also mappable to either interrupt pin. 00000: timer is off. 00001: timer expires after 160 ms. 00010: timer expires after 320 ms. 00011: timer expires after 640 ms. 00100: timer expires after 1.28 seconds. 00101: timer expires after 2.56 seconds. 00110: timer expires after 5.12 seconds. 00111: timer expires after 10.24 seconds. 01000: timer expires after 20.48 seconds. 01001: timer expires after 40.96 seconds. 01010: timer expires after 81.92 seconds. 01011: timer expires after 163.9 seconds. 01100: timer expires after 5.45 minutes. 01101: timer expires after 11 minutes. 01110: timer expires after 21.8 minutes. 01111: timer expires after 43.7 minutes. 10000: timer expires after 1.45 hours. 10001: timer expires after 3 hours. 10010: timer expires after 5.83 hours.	0x0	R/W

REGISTER DETAILS

Table 63. Bit Descriptions for *TIMER_CTL*

Bits	Bit Name	Description	Reset	Access
		10011: timer expires after 11.65 hours.		
		10100: timer expires after 23.2 hours.		

INTERRUPT PIN 1 ENABLES (UPPER) REGISTER

Address: 0x3A, Reset: 0x00, Name: INTMAP1_UPPER

Maps interrupts to INT1 pin.

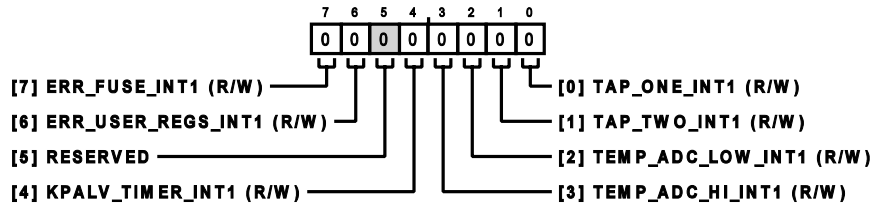
Table 64. Bit Descriptions for *INTMAP1_UPPER*

Bits	Bit Name	Description	Reset	Access
7	ERR_FUSE_INT1	Configures whether fuse error is mapped to the INT1 pin. 1: interrupt enabled. 0: interrupt disabled.	0x0	R/W
6	ERR_USER_REGS_INT1	Configures whether user register error is mapped to the INT1 pin. 1: interrupt enabled. 0: interrupt disabled.	0x0	R/W
5	RESERVED	Reserved.	0x0	R
4	KPALV_TIMER_INT1	A setting of 1 maps the keep alive timer to the INT1 pin. A setting of 0 does not map this interrupt to the INT1 pin. 1: interrupt enabled. 0: interrupt disabled.	0x0	R/W
3	TEMP_ADC_HI_INT1	A setting of 1 maps the temperature activity detection to the INT1 pin. A setting of 0 does not map this interrupt to the INT1 pin. 1: interrupt enabled. 0: interrupt disabled.	0x0	R/W
2	TEMP_ADC_LOW_INT1	A setting of 1 maps the temperature inactivity to the INT1 pin. A setting of 0 does not map this interrupt to the INT1 pin. 1: interrupt enabled. 0: interrupt disabled.	0x0	R/W
1	TAP_TWO_INT1	A setting of 1 maps double tap detection to the INT1 pin. A setting of 0 does not map this interrupt to the INT1 pin. 1: interrupt enabled. 0: interrupt disabled.	0x0	R/W
0	TAP_ONE_INT1	A setting of 1 maps tap detection to the INT1 pin. A setting of 0 does not map this interrupt to the INT1 pin. 1: interrupt enabled. 0: interrupt disabled.	0x0	R/W

INTERRUPT PIN 2 ENABLES (UPPER) REGISTER

Address: 0x3B, Reset: 0x00, Name: INTMAP2_UPPER

Maps interrupts to INT2 pin.

REGISTER DETAILS

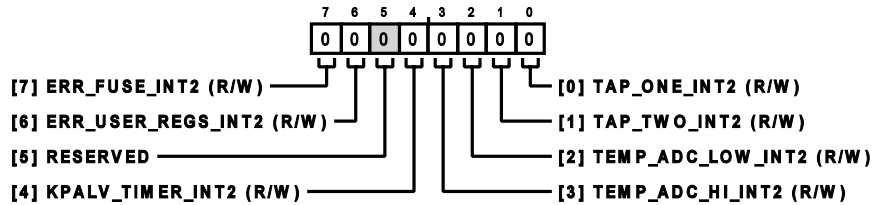

Table 65. Bit Descriptions for INTMAP2_UPPER

Bits	Bit Name	Description	Reset	Access
7	ERR_FUSE_INT2	Configures whether the fuse error is mapped to an INT2 pin. 1: interrupt enabled. 0: interrupt disabled.	0x0	R/W
6	ERR_USER_REGS_INT2	Configures whether user register error is mapped to INT2 pin. 1: interrupt enabled. 0: interrupt disabled.	0x0	R/W
5	RESERVED	Reserved.	0x0	R
4	KPALV_TIMER_INT2	A setting of 1 maps the keep alive timer to the INT1 pin. A setting of 0 does not map this interrupt to the INT1 pin. 1: interrupt enabled. 0: interrupt disabled.	0x0	R/W
3	TEMP_ADC_HI_INT2	A setting of 1 maps the temperature activity detection to the INT2 pin. A setting of 0 does not map this interrupt to the INT2 pin. 1: interrupt enabled. 0: interrupt disabled.	0x0	R/W
2	TEMP_ADC_LOW_INT2	A setting of 1 maps temperature inactivity to the INT2 pin. A setting of 0 does not map this interrupt to the INT2 pin. 1: interrupt enabled. 0: interrupt disabled.	0x0	R/W
1	TAP_TWO_INT2	A setting of 1 maps double tap detection to the INT2 pin. A setting of 0 does not map this interrupt to the INT2 pin. 1: interrupt enabled. 0: interrupt disabled.	0x0	R/W
0	TAP_ONE_INT2	A setting of 1 maps tap detection to the INT2 pin. A setting of 0 does not map this interrupt to the INT2 pin. 1: interrupt enabled. 0: interrupt disabled.	0x0	R/W

ADC CONTROL REGISTER

Address: 0x3C, Reset: 0xC0, Name: ADC_CTL

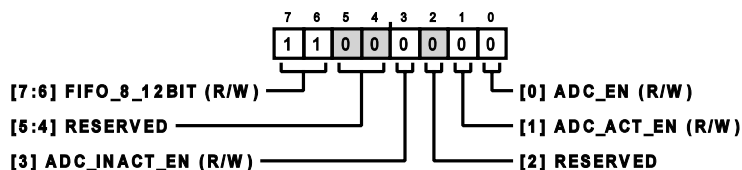

Table 66. Bit Descriptions for ADC_CTL

Bits	Bit Name	Description	Reset	Access
[7:6]	FIFO_8_12BIT	This 2-bit field defines how data is read out of the FIFO. The data is written into the FIFO in full 14-bit mode and the read out mode is determined by these bits. 00: FIFO data ADXL362 standard (upper 12 bits + channel ID).	0x3	R/W

REGISTER DETAILS

Table 66. Bit Descriptions for ADC_CTL

Bits	Bit Name	Description	Reset	Access
		01: 8-bit FIFO data (no channel ID, upper 8 bits of data sent out). 10: 12-bit FIFO data (no channel ID, upper 12 bits of data sent out). 11: FIFO data default (14 bits + channel ID).		
[5:4]	RESERVED	Reserved.	0x0	R
3	ADC_INACT_EN	Inactivity detection enabled on external ADC channel.	0x0	R/W
2	RESERVED	Reserved.	0x0	R/W
1	ADC_ACT_EN	Activity detection enabled on external ADC channel.	0x0	R/W
0	ADC_EN	Enable External ADC. If the TEMP_EN bit (Register 0x3D) = 1, the ADC is not enabled and this bit has no effect.	0x0	R/W

TEMPERATURE CONFIGURATION REGISTER

Address: 0x3D, Reset: 0x00, Name: TEMP_CTL

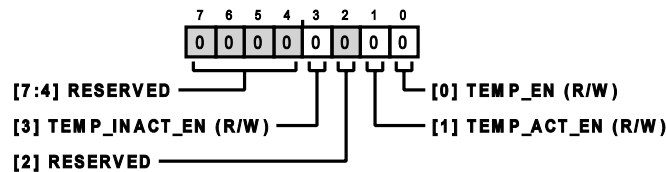

Table 67. Bit Descriptions for TEMP_CTL

Bits	Bit Name	Description	Reset	Access
[7:4]	RESERVED	Reserved.	0x0	R
3	TEMP_INACT_EN	A setting of 1 in the TEMP_INACT_EN bit enables inactivity detection on the temperature channel. A setting of 0 disables this feature.	0x0	R/W
2	RESERVED	Reserved.	0x0	R/W
1	TEMP_ACT_EN	A setting of 1 in the TEMP_ACT_EN bit enables activity detection on the temperature channel. A setting of 0 disables this feature.	0x0	R/W
0	TEMP_EN	A setting of 1 in the TEMP_EN bit enables a temperature conversion to occur along with acceleration at the ODR setting. A setting of 0 disables this feature.	0x0	R/W

TEMP_ADC_ACT_THRSH_HIGH REGISTER

Address: 0x3E, Reset: 0x00, Name: TEMP_ADC_OVER_THRSH_H

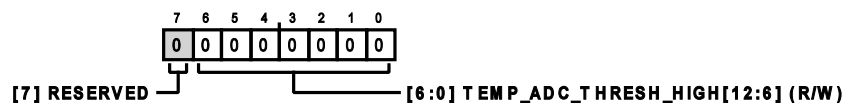

Table 68. Bit Descriptions for TEMP_ADC_OVER_THRSH_H

Bits	Bit Name	Settings	Description	Reset	Access
7	RESERVED		Reserved.	0x0	R
[6:0]	TEMP_ADC_THRESH_HIGH[12:6]		To detect activity on the external ADC or temperature channel, the ADXL367 compares the absolute value of the 14-bit (signed) data with the 13-bit (unsigned) TEMP_ADC_THRESH_HIGH value. TEMP_ADC_THRESH_HIGH is set in codes (1 LSB = 1 code). The value in <i>g</i> depends on the measurement range setting that is selected.	0x0	R/W

TEMP_ADC_ACT_THRSH_LOW REGISTER

Address: 0x3F, Reset: 0x00, Name: TEMP_ADC_OVER_THRSH_L

REGISTER DETAILS

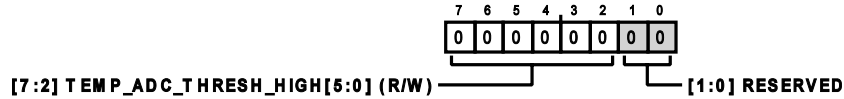

Table 69. Bit Descriptions for TEMP_ADC_OVER_THRSH_L

Bits	Bit Name	Settings	Description	Reset	Access
[7:2]	TEMP_ADC_THRESH_HIGH[5:0]		To detect activity on the external ADC Or temperature channel, the ADXL367 compares the absolute value of the 14-bit (signed) data with the 13-bit (unsigned) TEMP_ADC_THRESH_HIGH value. TEMP_ADC_THRESH_HIGH is set in codes (1 LSB = 1 code). The value in g depends on the measurement range setting that is selected.	0x0	R/W
[1:0]	RESERVED		Reserved.	0x0	R

TEMP_ADC_INACT_THRSH_HIGH REGISTER

Address: 0x40, Reset: 0x00, Name: TEMP_ADC_UNDER_THRSH_H

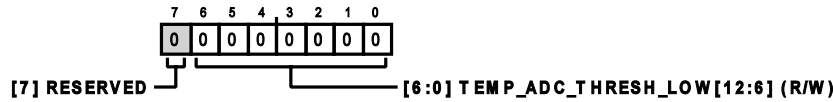

Table 70. Bit Descriptions for TEMP_ADC_UNDER_THRSH_H

Bits	Bit Name	Settings	Description	Reset	Access
7	RESERVED		Reserved.	0x0	R
[6:0]	TEMP_ADC_THRESH_LOW[12:6]		To detect inactivity on the external ADC or temperature channel, the ADXL367 compares the absolute value of the 14-bit (signed) data with the 13-bit (unsigned) TEMP_ADC_THRESH_HIGH value. TEMP_ADC_THRESH_LOW is set in codes (1 LSB = 1 code). The value in g depends on the measurement range setting that is selected.	0x0	R/W

TEMP_ADC_INACT_THRSH_LOW REGISTER

Address: 0x41, Reset: 0x00, Name: TEMP_ADC_UNDER_THRSH_L

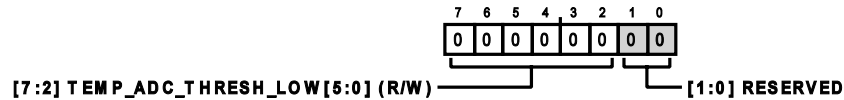
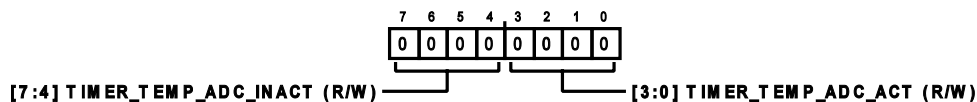

Table 71. Bit Descriptions for TEMP_ADC_UNDER_THRSH_L

Bits	Bit Name	Settings	Description	Reset	Access
[7:2]	TEMP_ADC_THRESH_LOW[5:0]		To detect inactivity on the external ADC or temperature channel, the ADXL367 compares the absolute value of the 14-bit (signed) data with the 13-bit (unsigned) TEMP_ADC_THRESH_HIGH value. TEMP_ADC_THRESH_LOW is set in codes (1 LSB = 1 code). The value in g depends on the measurement range setting that is selected.	0x0	R/W
[1:0]	RESERVED		Reserved.	0x0	R

TEMPERATURE ACTIVITY INACTIVITY TIMER REGISTER

Address: 0x42, Reset: 0x00, Name: TEMP_ADC_TIMER



REGISTER DETAILS

Table 72. Bit Descriptions for TEMP_ADC_TIMER

Bits	Bit Name	Settings	Description	Reset	Access
[7:4]	TIMER_TEMP_ADC_INACT		The value in this bit field sets the number of consecutive samples that must have a value less than the activity threshold (set by TEMP_ADC_THRESH_LOW) for an inactivity event to be detected.	0x0	R/W
[3:0]	TIMER_TEMP_ADC_ACT		The value in this bit field sets the number of consecutive samples that must have a value greater than the activity threshold (set by TEMP_ADC_THRESH_HI) for an activity event to be detected.	0x0	R/W

AXIS MASK REGISTER

Address: 0x43, Reset: 0x00, Name: AXIS_MASK

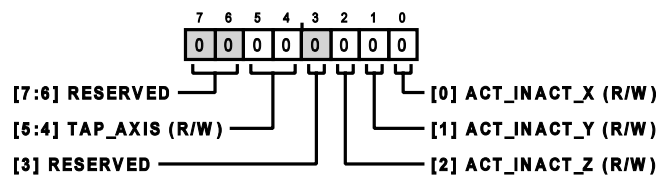

Table 73. Bit Descriptions for AXIS_MASK

Bits	Bit Name	Description	Reset	Access
[7:6]	RESERVED	Reserved.	0x0	R
[5:4]	TAP_AXIS	Select which axis to be looked at for tap detection. 00: x-axis 01: y-axis 10: Z-axis	0x0	R/W
3	RESERVED	Reserved.	0x0	R
2	ACT_INACT_Z	Set to 1 to block activity and inactivity checking on the z-axis, checking on by default.	0x0	R/W
1	ACT_INACT_Y	Set to 1 to block activity and inactivity checking on the y-axis, checking on by default.	0x0	R/W
0	ACT_INACT_X	Set to 1 to block activity and inactivity checking on the x-axis, checking on by default.	0x0	R/W

STATUS COPY REGISTER

Address: 0x44, Reset: 0x40, Name: STATUS_COPY

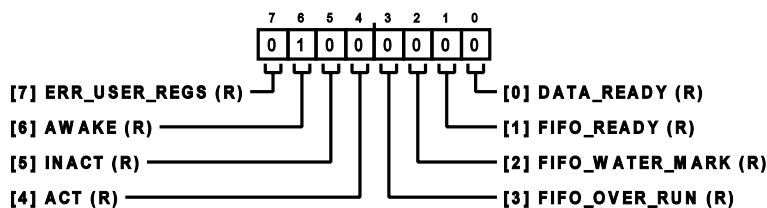

Table 74. Bit Descriptions for STATUS_COPY

Bits	Bit Name	Description	Reset	Access
7	ERR_USER_REGS	SEU Error Detect. 1 indicates one of two conditions: either an SEU event, such as an alpha particle of a power glitch, has disturbed a user register setting or the ADXL367 is not configured. This bit is high on both startup and soft reset, and resets as soon as any register write commands are performed.	0x0	R
6	AWAKE	Indicates whether the accelerometer is in an active (AWAKE = 1) or inactive (AWAKE = 0) state, based on the activity and inactivity functionality. To enable autosleep, activity and inactivity detection must be in linked mode or loop mode (LINKLOOP bits in the ACT_INACT_CTL register). Otherwise, this bit defaults to 1 and must be ignored. 0: device is inactive. 1: device is active (reset state).	0x1	R

REGISTER DETAILS

Table 74. Bit Descriptions for STATUS_COPY

Bits	Bit Name	Description	Reset	Access
5	INACT	Inactivity. 1 indicates that the inactivity detection function has detected an inactivity or a free fall condition.	0x0	R
4	ACT	Activity. 1 indicates that the activity detection function has detected an overthreshold condition.	0x0	R
3	FIFO_OVER_RUN	FIFO Overrun. 1 indicates that the FIFO has overrun or overflowed. No new data is written to the FIFO until a FIFO read has occurred to free up some space for new data. FIFO_OVER_RUN is only available in FIFO_MODE = oldest saved mode.	0x0	R
2	FIFO_WATER_MARK	FIFO Watermark. 1 indicates that the FIFO contains at least the desired number of samples, as set in the FIFO_SAMPLES register. FIFO_WATER_MARK is asserted when the next sample (greater than the value) is written to the FIFO.	0x0	R
1	FIFO_READY	FIFO Ready. 1 indicates that there is at least one sample available in the FIFO output buffer.	0x0	R
0	DATA_READY	Data Ready. 1 indicates that a new valid sample is available to be read. This bit clears when a DATA read is performed. DATA_READY is set when new valid data is available. It is cleared when no new data is available. The DATA_READY bit is not set while any of the data registers, Address 0x08 to Address 0x0A and Address 0x0E to Address 0x17, are being read. If DATA_READY = 0 prior to a register read and new data becomes available during the register read, DATA_READY remains at 0 until the read is complete and, only then, is set to 1. If DATA_READY = 1 prior to a register read, it is cleared at the start of the register read. If DATA_READY = 1 prior to a register read and new data becomes available during the register read, DATA_READY is cleared to 0 at the start of the register read and remains at 0 throughout the read. When the read is complete, DATA_READY is set to 1.	0x0	R

STATUS 2 REGISTER

Address: 0x45, Reset: 0x00, Name: STATUS2

Status 2 Register.

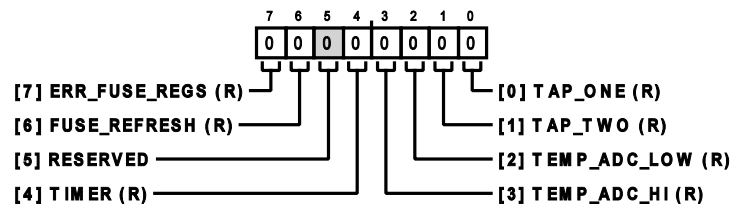

Table 75. Bit Descriptions for STATUS2

Bits	Bit Name	Settings	Description	Reset	Access
7	ERR_FUSE_REGS		Fuse Error Detect. A 1 indicates that multiple fuses have been corrupted and the correction engine cannot repair them.	0x0	R
6	FUSE_REFRESH		A 1 indicates that the nonvolatile memory (NVM) has had to reload. A software or hardware reset is recommended. Reading the STATUS2 register clears this bit.	0x0	R
5	RESERVED		Reserved.	0x0	R
4	TIMER		A 1 indicates that the keep alive timer has expired. Reading the STATUS2 register clears the timer interrupt and reset timer.	0x0	R
3	TEMP_ADC_HI		Over threshold is detected on either the temperature or external ADC channel. If TEMP_EN = 1, this bit indicates that a temperature over threshold event has been detected.	0x0	R
2	TEMP_ADC_LOW		Under threshold is detected on either the temperature sensor or external ADC. If TEMP_EN = 1, this bit indicates that a temperature under threshold event has been detected.	0x0	R
1	TAP_TWO		The TAP_TWO bit is set when two acceleration events that are greater than the value in the THRESH_TAP register occur for less time than is specified in the TAP_DUR register. The second tap starts after the time specified by the TAP_LATENCY register, but within the time specified in the TAP_WINDOW register.	0x0	R
0	TAP_ONE		The TAP_ONE bit is set when a single acceleration event that is greater than the value in the THRESH_TAP register occurs for less time than is specified in the TAP_DUR register.	0x0	R

APPLICATIONS INFORMATION

APPLICATION EXAMPLES

The [Device Configuration](#) section, [Autonomous Motion Switch](#) section, [Using External Timing Triggers](#) section, and [Example: Implementing Free Fall Detection](#) section include a few application circuits, highlighting useful features of the ADXL367.

Device Configuration

This section outlines the procedure for configuring the device and acquiring data. In general, the procedure follows the sequence of the register map, starting with Register 0x20 (THRESH_ACT_L). The following is a general sequence for configuration:

1. Set activity and inactivity thresholds and timers by writing to Register 0x20 to Register 0x26. To minimize false positive motion triggers, set the TIME_ACT register greater than 1.
2. Configure activity and inactivity functions by writing to Register 0x27.
3. Configure FIFO by writing to Register 0x28 and Register 0x29.
4. Map the interrupts by writing to Register 0x2A and Register 0x2B.
5. Configure general device settings by writing to Register 0x2C.
6. Enter measurement mode by writing 10 to the MEASURE bit field in Register 0x2D.

Settings for each of the registers vary based on application requirements. For more information, see the [Register Details](#) section.

Autonomous Motion Switch

The features of the ADXL367 make it ideal for use as an autonomous motion switch. The [Start-Up Routine](#) section implements a switch that, when configured, operates without the intervention of a host processor to intelligently manage system power. In the example in [Figure 17](#), the awake signal, mapped to the INT2 pin, drives a high-side power switch, such as the [ADP195](#), to control power to the downstream circuitry.

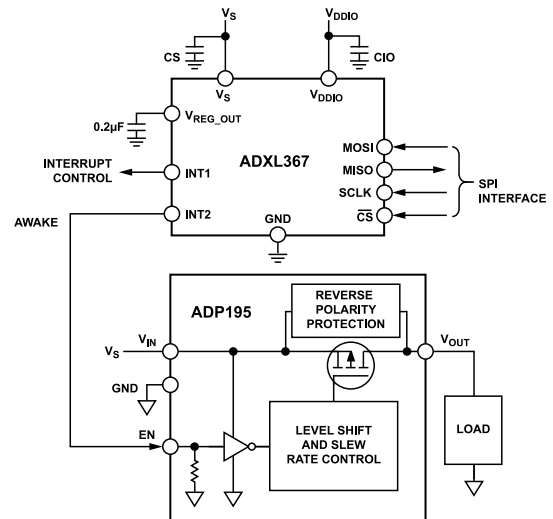

Figure 56. Awake Signal to Control Power to Downstream Circuitry

Start-Up Routine

The start-up routine assumes a $\pm 2 g$ measurement range and operation in measurement mode. The following sequence is an example routine to configure the ADXL367 as an autonomous motion switch, but note that the threshold settings depend on the specific application use case:

1. Write 0xA0 to Register 0x20 and write 0x0F to Register 0x21, to set the activity threshold to 0.25 mg.
2. Write 0x60 to Register 0x23 and write 0x09 to Register 0x24, to set the inactivity threshold to 2 g.
3. Write 0x3F to Register 0x27 to enable referenced activity detection, referenced inactivity detection, and loop mode.
4. Write 0x01 to Register 0x2A to map the data ready interrupt to the INT1 pin.
5. Write 0x40 to Register 0x2B to map the AWAKE bit to the INT2 pin.
6. Write 0x02 to Register 0x2D to enter measurement mode. Wait 100 ms to allow the acceleration outputs to settle.
7. Write 0x0F to Register 0x20 and 0xA0 to Register 0x21 to set the activity threshold to 62.5 mg.
8. Write 0x0A to Register 0x23 and 0xF0 to Register 0x24 to set the inactivity threshold to 175 mg.

Note that Step 1 and Step 2 are needed to generate activity and inactivity interrupts immediately after entering measurement mode. This ensures that the ADXL367 starts in a known state when setting the activity and inactivity thresholds in loop mode.

Using External Timing Triggers

[Figure 57](#) shows an application diagram for using the INT1 pin as the input for an external clock. In this mode, the external clock determines all accelerometer timing, including the output data rate and bandwidth.

APPLICATIONS INFORMATION

To enable this feature, during configuration (while in standby mode), set Bit 6 in the POWER_CTL register. For example, write 0x42 to the POWER_CTL register to enable the use of an external clock and place the accelerometer into measurement mode.

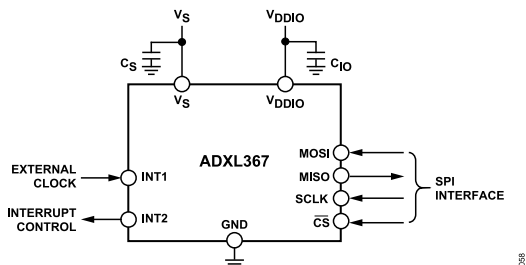

Figure 57. INT1 Pin as the Input for the External Clock

Figure 58 is an application circuit to use the INT2 pin as a trigger for synchronized sampling. Acceleration samples are produced every time this trigger is activated. To enable this feature, near the end of the desired start-up routine, set Bit 3 in the FILTER_CTL register. For example, write 0x6B to the FILTER_CTL register to enable the trigger and configure the accelerometer for a $\pm 4 g$ measurement range and 100 Hz ODR.

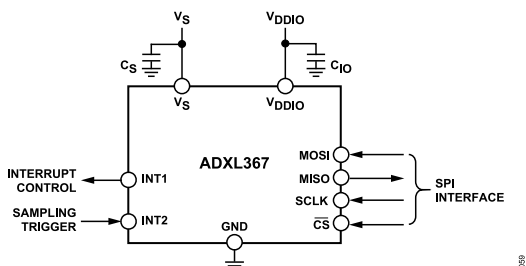

Figure 58. Using the INT2 Pin to Trigger Synchronized Sampling

Example: Implementing Free Fall Detection

Many digital output accelerometers include a built-in free fall detection feature. In the ADXL367, implement this function by using the inactivity interrupt.

When an object is in true free fall, acceleration on all axes is 0 g. Therefore, free fall detection is achieved by looking for acceleration on all axes to fall below a certain threshold (close to 0 g) for a certain amount of time. The inactivity detection functionality, when used in absolute mode, monitors the acceleration to watch for all three axes to drop to 0 g.

To use inactivity to implement free fall detection, set the value in the THRESH_INACT bits (Register 0x23 and Register 0x24) to the desired free fall threshold. Values between 300 mg and 600 mg are recommended. The register setting for these values varies based on the g range setting of the device, as shown in the following equation.

$$THRESH_INACT = \text{Threshold Value (g)} \times \text{Scale Factor (LSB per g)}$$

Set the value in the TIME_INACT bits (Register 0x25 and Register 0x26) to implement the minimum amount of time that the acceleration on all axes must be less than the free fall threshold to generate a free fall condition. Values between 100 ms and 350 ms are recommended. The register setting for free fall detection varies based on the output data rate. The following equation dictates which TIME_INACT bits setting the user must choose. In this equation, Time represents the time that all acceleration axes must be below the inactivity threshold for free fall to be detected.

$$TIME_INACT = \text{Time (sec)} \times \text{Data Rate (Hz)}$$

When a free fall condition is detected, the inactivity status is set to 1 and, if the function is mapped to an interrupt pin, an inactivity interrupt triggers on that pin.

Start-Up Routine

The following start-up routine configures the ADXL367 for a typical free fall application. This routine assumes a $\pm 8 g$ measurement range and 100 Hz output data rate. Thresholds and timing values can be modified to suit particular application needs. Use the following procedure for start-up:

1. Write 0x18 to Register 0x24 and 0x09 to Register 0x23, to set the free fall threshold to 600 mg.
2. Write 0x03 to Register 0x26 to set the free fall time to 30 ms.
3. Write 0x04 to Register 0x27 to enable absolute inactivity detection.
4. Write 0x20 to Register 0x2A or Register 0x2B to map the inactivity interrupt to the INT1 pin or INT2 pin, respectively.
5. Write 0x83 to Register 0x2C to configure the accelerometer to the $\pm 8 g$ range and 100 Hz ODR.
6. Write 0x02 to Register 0x2D: enter measurement mode. Note that a 100 ms wait time must be observed before the acceleration data becomes valid.

POWER SUPPLY REQUIREMENTS

The ADXL367 operates using supply voltage rails ranging from 1.1 V to 3.6 V. The operating voltage range (V_S) specified in Table 1 ranges from 1.1 V to 3.6 V to account for inaccuracies and transients of up to $\pm 10\%$ on the supply voltage. Although the run time supply current is much lower, during power up or software reset the supply current must be greater than 250 μA . This ensures that the internal fuses are loaded correctly. When power cycling the ADXL367, it is highly recommended to fully discharge the device to ground level ($V_S = 0 V$) on each power cycle. If this is not possible, care must be taken regarding the following specifications:

- ▶ Supply Reset Threshold (V_{RESET})
- ▶ Hold Time
- ▶ Rise Time

APPLICATIONS INFORMATION

Supply Reset Threshold

During start-up or power cycling of the ADXL367, the V_S supply value must be increased from its previous value, which was less than V_{RESET} . When the device is in operation, any time power is removed from the ADXL367 or falls below 1.1 V, the V_S supply must be discharged to a value less than V_{RESET} .

Hold Time

To ensure a successful power-on reset, the V_S supply must be held at a value that is less than V_{RESET} for at least 300 ms before reapplying the supply to the device (see Figure 59).

Rise Time

The supply voltage rise time is defined as the time from 0 V to 90% of V_S . This is true regardless of what supply voltage is used (see the Power Supply Requirements section).

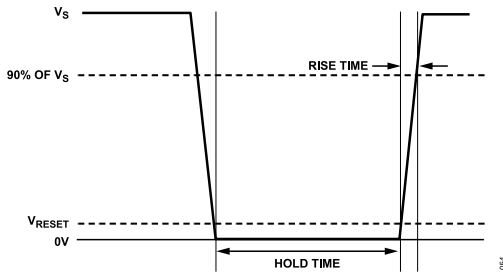

Figure 59. Power Supply Reset and Start-Up Requirements

To enable supply discharge, it is recommended to power the device from a microcontroller GPIO, connect a shutdown discharge switch to the supply, or use a voltage regulator with a shutdown discharge feature.

Following power-on reset (POR), the output requires 100 ms to settle after entering measurement mode.

Power Supply Decoupling

Figure 60 shows the recommended bypass capacitors for use with the ADXL367.

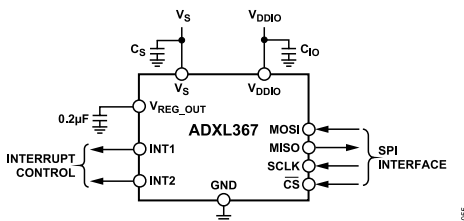

Figure 60. Recommended Bypass Capacitors

A 0.1 μF ceramic capacitor (named C_S) at the V_S pin and a 0.1 μF ceramic capacitor (named C_{IO}) at the V_{DDIO} pin are placed as close as possible to the ADXL367. Supply pins are recommended

to adequately decouple the accelerometer from noise on the power supply. It is also recommended that V_S and V_{DDIO} be separate supplies to minimize digital clocking noise on the V_S supply. If this is not possible, additional filtering of the supplies may be necessary.

If additional decoupling is necessary, place a resistor or ferrite bead, no larger than 100 Ω , in series with V_S . Additionally, increasing the bypass capacitance on V_S to a 1 μF tantalum capacitor in parallel with a 0.1 μF ceramic capacitor may also improve noise. Note that increasing the resistor and capacitor values increases the RC time constant. This affects the reset time of the device. This means the user needs a longer reset time. Turn-on time may also be slower.

Ensure that the connection from the ADXL367 ground to the power supply ground has low impedance because noise transmitted through ground has an effect similar to noise transmitted through V_S .

For single supply condition, the decoupling schematics, as shown in Figure 61, can be considered if additional decoupling is necessary. The resistance between V_S and V_{DDIO} must be no greater than 10 Ω .

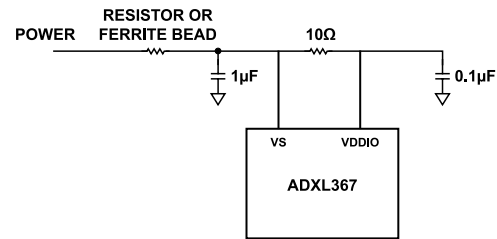

Figure 61. Recommended Decoupling Schematics for Single Supply

FIFO MODES

The FIFO is a 512-sample memory buffer that can be used to save power, unburden the host processor, and autonomously record data. Note that to guarantee inertial data from the same sample, the user must read a complete set of data (for example, x-channel, y-channel, z-channel, temperature) consecutively. If the channels are not read consecutively, there is a chance of missing data.

The FIFO operates in one of the four modes described in the FIFO Disabled section, Oldest Saved Mode section, Stream Mode section, and Triggered Mode section.

FIFO Disabled

When the FIFO is disabled, no data is stored in it and any data already stored in it is cleared.

The FIFO is disabled by setting the FIFO_MODE bits in the FIFO_CONTROL register (Address 0x28) to the Binary Value 0b00.

APPLICATIONS INFORMATION

Oldest Saved Mode

In oldest saved mode, the FIFO accumulates data until it is full and then stops. Additional data is collected only when space is made available by reading samples out of the FIFO buffer (this mode of operation is sometimes referred to as first N)

The FIFO is placed into oldest saved mode by setting the FIFO_MODE bits in the FIFO_CONTROL register (Address 0x28) to Binary Value 0b01.

Stream Mode

In stream mode, the FIFO always contains the most recent data. The oldest sample is discarded when space is needed to make room for a newer sample (this mode of operation is sometimes referred to as last N).

Stream mode is useful for unburdening a host processor. The processor can tend to other tasks while data is being collected in the FIFO. When the FIFO fills to a certain number of samples (specified by the FIFO_SAMPLES register along with the FIFO_SAMPLE bit in the FIFO_CONTROL register), it triggers a FIFO watermark interrupt (if this interrupt is enabled). At this point, the host processor can read the contents of the entire FIFO and then return to its other tasks as the FIFO fills again.

The FIFO is placed into stream mode by setting the FIFO_MODE bits in the FIFO_CONTROL register (Address 0x28) to Binary Value 0b10.

Triggered Mode

In triggered mode, the FIFO saves samples surrounding an activity detection event. The operation is similar to a one-time run trigger on an oscilloscope. The number of samples to be saved prior to the activity event is specified in FIFO_SAMPLES (Register 0x29, along with the FIFO_SAMPLE bit in the FIFO_CONTROL register, Address 0x28).

Place the FIFO into triggered mode by setting the FIFO_MODE bits in the FIFO_CONTROL register (Address 0x28) to Binary Value 0b11.

FIFO CONFIGURATION

The FIFO mode is configured via Register 0x28 and Register 0x29. The FIFO data structure is configured via Register 0x3C. Settings are described in detail in the [Register Details](#) section.

FIFO Interrupts

The FIFO can generate interrupts to indicate when samples are available, when a specified number of samples has been collected, and when the FIFO overflows and samples are lost. See the [Using FIFO Interrupts](#) section for more information.

Retrieving Data from FIFO

FIFO data is read by issuing a FIFO read command, described in the [Serial Communications](#) section. The ADXL367 FIFO can support 14 bits or 12 bits with data type information available, as shown in [Table 76](#) and [Table 77](#).

Table 76. 14-Bit Data

Bits	Bit Name	Settings
D[15:14]	Data Type	00: x-axis 01: y-axis 10: z-axis 11: temperature/ external ADC
D[13]	MSB	
D[12:1]	Data	
D[0]	LSB	

Table 77. 12-Bit Data

Bits	Bit Name	Settings
D[15:14]	Data Type	00: x-axis 01: y-axis 10: z-axis 11: temperature/ external ADC
D[13:12]	Sign Extend	
D[11]	MSB	
D[10:1]	Data	
D[0]	LSB	

The ADXL367 also supports data packed mode to increase data throughput and save system power. An 8-bit data word is provided for readback. In 8-bit mode, only the upper 8 bits of a sample are sent out, and no channel ID is prepended. Therefore, the user can get the most efficient data transfer, just 8 bits per stored sample (at the cost of full data resolution). A 12-bit data word is provided for readback. In 12-bit mode, only the upper 12 bits of a sample are sent out, no channel ID is prepended. Therefore, the user can get a more efficient data transfer, 2 words (24 bits) into 3 bytes. There is still a resolution cost associated because only 12 bits per stored sample are being sent. The data format for the packed modes is shown in [Table 78](#) and [Table 79](#).

Table 78. 8-Bit Packed Format

Byte	Byte Name	Number of Bits
Byte 1	Sample 1	8
Byte 0	Sample 0	8

Table 79. 12-Bit Packed Format

Byte	Byte Name
Byte 2	Sample 1[11:4]
Byte 1[7:4]	Sample 1[3:0]
Byte 1[3:0]	Sample 0[11:8]
Byte 0	Sample 0[7:0]

APPLICATIONS INFORMATION

The FIFO can store up to 513 data entries. There is a 512-sample memory buffer plus one data holding register, which are divided into repeating data sets. A data set contains one sample of data for each selected measurement. The measurements include the following:

- ▶ Acceleration: any one axis or all three axes can be stored in the FIFO. This selection is made in the FIFO_CTL register.
- ▶ Temperature: temperature can either be stored in the FIFO or not, as specified in the FIFO_CTL register.
- ▶ ADC: ADC can either be stored in the FIFO or not, as specified in the FIFO_CTL register.

The 513 FIFO samples can be allocated in several ways, such as the following:

- ▶ 513 sample sets of single-axis data
- ▶ 256 sample sets of concurrent 2-channel data
- ▶ 171 sample sets of concurrent 3-channel data
- ▶ 128 sample sets of concurrent 4-channel data
- ▶ Note that the FIFO conversion channel must be configured in standby mode.

Table 80. FIFO Data Structure

FIFO_CHANNEL Value	Sample Set Size (Channels)	Sample Set Stored in FIFO (Axis Acceleration Channels)
0000 (default)	3	X, Y, Z
0001	1	X
0010	1	Y
0011	1	Z
0100 ¹	4	X, Y, Z, temperature
0101 ¹	2	X, temperature
0110 ¹	2	Y, temperature
0111 ¹	2	Z, temperature
1000 ¹	4	X, Y, Z, external ADC
1001 ¹	2	X, external ADC
1010 ¹	2	Y, external ADC
1011 ¹	2	Z, external ADC
11xx	x	Not used

¹ For either FIFO_ADC or FIFO_TEMP to allow for that data to be stored in the FIFO, the corresponding feature must be enabled using bit fields in separate control registers (ADC_EN bits in the ADC_CTL register and the TEMP_EN bits in the TEMP_CTL register, respectively).

APPLICATIONS INFORMATION

INTERRUPTS

Several of the built-in functions of the ADXL367 can trigger interrupts to alert the host processor of certain status conditions. The [Interrupt Pins](#) section, [Alternate Functions of Interrupt Pins](#) section, [Activity and Inactivity Interrupts](#) section, [External ADC Interrupt](#) section, and [Data Ready Interrupt](#) section describes the functionality of these interrupts.

Interrupt Pins

Interrupts can be mapped to either (or both) of two designated output pins, INT1 and INT2, by setting the appropriate bits in the INTMAP1_LOWER, INTMAP1_UPPER, INTMAP2_LOWER, and INTMAP2_UPPER registers, respectively. All functions can be used simultaneously. If multiple interrupts are mapped to one pin, the OR combination of the interrupts determines the status of the pin.

If no functions are mapped to an interrupt pin, that pin is automatically configured to a high impedance (high-Z) state. The pins are also placed in the high-Z state on a reset.

When a certain status condition is detected, the pin that condition is mapped to is activated. The configuration of the pin is active high by default so that when it is activated, the pin goes high. However, this configuration can be switched to active low by setting the INT_LOW bit in the appropriate INTMAP1_x and INTMAP2_x registers.

The INTx pins can be connected to the interrupt input of a host processor where interrupts are responded to with an interrupt routine. Because multiple functions can be mapped to the same pin, the STATUS register can be used to determine which condition caused the interrupt to trigger.

Clear interrupts in one of the following several ways:

- ▶ Reading the STATUS register (Address 0x0B) clears activity and inactivity interrupts.
- ▶ Reading from the data registers, Address 0x08 to Address 0x0A or Address 0x0E to Address 0x15, clears the data ready interrupt.
- ▶ Reading enough data from the FIFO buffer so that interrupt conditions are no longer met clears the FIFO ready, FIFO watermark, and FIFO overrun interrupts.

Both interrupt pins are push and pull low impedance pins with an output impedance of 50 Ω (typical at $V_{DDIO} = 2$ V) when being driven and following the digital output specifications, as shown in [Table 81](#). Both pins have bus keepers when the pins are not internally driven.

To prevent interrupts from being falsely triggered during configuration, disable interrupts while their settings, such as thresholds, timings, or other values, are configured.

Table 81. Interrupt Pin Digital Output

Parameter	Test Conditions	Limit ¹		Unit
		Min	Max	
Digital Output				
Low Level Output Voltage (V_{OL})	$I_{OL} = 500 \mu\text{A}$		$0.1 \times V_{DDIO}$	V
High Level Output Voltage (V_{OH})	$I_{OH} = -300 \mu\text{A}$	$0.9 \times V_{DDIO}$		V
Low Level Output Current (I_{OL})	$V_{OL} = V_{OL, MAX}$	500		μA
High Level Output Current (I_{OH})	$V_{OH} = V_{OH, MIN}$		-300	μA

¹ Limits based on design, not production tested.

APPLICATIONS INFORMATION

Alternate Functions of Interrupt Pins

The INT1 pin and INT2 pin can be configured for use as input pins instead of for signaling interrupts. INT1 is used as an external clock input when the EXT_CLK bit (Bit 6) in the POWER_CTL register (Address 0x2D) is set. INT2 is used as the trigger input for synchronized sampling when the EXT_SAMPLE bit (Bit 3) in the FILTER_CTL register (Address 0x2C) is set. One or both of these alternate functions can be used concurrently. However, if an alternate function of an interrupt pin is used, the interrupt pin cannot simultaneously be used for its primary function, to signal interrupts.

External clocking and data synchronization are described in the [Applications Information](#) section.

Activity and Inactivity Interrupts

The ACT bit (Bit 4) and INACT bit (Bit 5) in the STATUS register are set when activity and inactivity are detected, respectively. Detection procedures and criteria are described in the [Motion Detection](#) section.

External ADC Interrupt

The ADXL367 incorporates a 14-bit ADC for digitization of an external analog input. An interrupt can be generated based on the user set threshold of the external ADC. For the battery powered device, the external ADC can be used to monitor the supply voltage. After the supply voltage is lower than the specified threshold, an interrupt can be generated to alert the end user to charge/change the battery. By using this function, the host processor does not have to use one more ADC to check the power supply periodically.

Data Ready Interrupt

The DATA_READY bit (Register 0x0B, Bit 0) is set when new valid data is available, and it is cleared when no new data is available.

The DATA_READY bit is not set while any of the data registers, Address 0x08 to Address 0x0A and Address 0x0E to Address 0x15, are being read. If DATA_READY = 0 prior to a register read and new data becomes available during the register read, DATA_READY remains at 0 until the read is complete and, only then, is set to 1.

If DATA_READY = 1 prior to a register read, it is cleared at the start of the register read.

If DATA_READY = 1 prior to a register read and new data becomes available during the register read, DATA_READY is cleared to 0 at the start of the register read and remains at 0 throughout the read. When the read is complete, DATA_READY is set to 1.

Using FIFO Interrupts

FIFO Watermark

The FIFO_WATERMARK bit (Register 0x0B, Bit 2) is set when the number of samples stored in the FIFO is equal to or exceeds the number of samples specified in the FIFO_SAMPLES register (Address 0x29) together with the FIFO_SAMPLES bit in the FIFO_CONTROL register (Bit 2, Address 0x28). The FIFO_WATERMARK bit is cleared automatically when enough samples are read from the FIFO so that the number of samples remaining is lower than the value set by the user in the FIFO_SAMPLES bit field.

If the number of FIFO samples is set to 0, the FIFO watermark interrupt is set. To avoid unexpectedly triggering this interrupt, the default value of the FIFO_SAMPLES register is 0x80.

FIFO Ready

The FIFO_READY bit (Register 0x44, Bit 1) is set when there is at least one valid sample available in the FIFO output buffer. This bit is cleared when no valid data is available in the FIFO.

Overrun

The FIFO_OVERRUN bit (Register 0x44, Bit 3) is set when the FIFO has overrun or overflowed, indicating that new data has replaced unread data. This may indicate a full FIFO that has not yet been emptied or a clocking error caused by a slow SPI transaction. If the FIFO is configured to oldest saved mode, an overrun event indicates that there is insufficient space available for a new sample.

The FIFO_OVERRUN bit is cleared automatically when the contents of the FIFO are read. Likewise, when the FIFO is disabled, the FIFO_OVERRUN bit is cleared.

USING EXTERNAL TRIGGER

For applications that require a precisely timed acceleration measurement, the ADXL367 features an option to synchronize acceleration sampling to an external trigger. The EXT_SAMPLE bit (Bit 3) in the FILTER_CTL register (Address 0x2C) enables this feature. When the EXT_SAMPLE bit is set to 1, the INT2 pin is automatically reconfigured for use as the synchronization trigger input. Note that the external trigger only works in measurement mode.

When external triggering is enabled, it is up to the system designer to ensure that the sampling frequency meets system requirements. Sampling too infrequently causes aliasing. Noise can be lowered by oversampling. However, sampling at too high a frequency may not allow enough time for the accelerometer to process the acceleration data and convert it to valid digital output.

When Nyquist criteria are met, signal integrity is maintained. An internal antialiasing filter is available in the ADXL367 and can assist the system designer in maintaining signal integrity. To prevent aliasing, set the filter bandwidth to a frequency no greater than $\frac{1}{2}$

APPLICATIONS INFORMATION

the sampling rate. For example, when sampling at 100 Hz, set the filter pole to no higher than 50 Hz. The filter pole is set via the ODR bits in the FILTER_CTL register (Address 0x2C). The filter bandwidth is set to $\frac{1}{2}$ the ODR and is set via the ODR bits. Even though the ODR is ignored (because the data rate is set by the external trigger), the filter is still applied at the specified bandwidth.

Because of internal timing requirements, the trigger signal applied to the INT2 pin must meet the following criteria:

- ▶ The trigger signal is active high.
- ▶ The pulse width of the trigger signal must be at least 80 μ s.
- ▶ The trigger must be deasserted for at least 120 μ s before it is reasserted.
- ▶ The maximum sampling frequency that is supported is 625 Hz (typical).
- ▶ The minimum sampling frequency is set only by system requirements. Samples do not have to be polled at any minimum rate. However, if samples are polled at a rate lower than the bandwidth set by the antialiasing filter, aliasing may occur.

USING AN EXTERNAL CLOCK

The ADXL367 has a built-in clock that, by default, is used for clocked internal operations. If desired, an external clock can be provided and used.

To use an external clock, the EXT_CLK bit (Bit 6) in the POWER_CTL register (Address 0x2D) must be set. Setting this bit reconfigures the INT1 pin to an input pin on which the clock can be provided. The external clock must operate between 51.2 kHz and 102.4 kHz. Further information is provided in the [External Clock](#) section.

USING SELF TEST

The ADXL367 has a two-step process to correctly record the self test signal levels. The self test function, described in the [Self Test](#) section, is enabled via the ST and ST_FORCE bits in the SELF_TEST register (Address 0x2E). The recommended procedure for using the self test functionality is as follows:

1. Enter measurement mode and wait 100 ms for output to settle.
2. Enable self test mode by setting the ST bit in the SELF_TEST register (Address 0x2E).
3. Wait 4/ODR for the output to settle to its new value.
4. Read acceleration data for the x-axis.
5. Apply self test force by setting the ST_FORCE bit in the SELF_TEST register (Address 0x2E).
6. Wait 4/ODR for the output to settle to its new value.
7. Read acceleration data for the x-axis.
8. Compare to the values from Step 3, and convert the difference from LSB to mg by multiplying by the sensitivity. If the observed difference falls within the self test output change specification listed in [Table 1](#), the device passes self test and is deemed operational.

9. Disable self test by clearing the ST and ST_FORCE bits in the SELF_TEST register (Address 0x2E).

The self test output change specification shown in [Table 1](#) is only given for $V_S = 2.0$ V and the test conditions listed in the [Specifications](#) section. Self test response in g is not proportional to the supply voltage because of the internal 1 V regulator. Due to the low supply voltage of the device, the x-axis self test force is approximately 0.17 g and a more robust ST reading can be made by averaging the x-axis output readings to lower the noise. It is recommended to average 4 to 16 samples to get the acceleration for self test force on and self test force off to alleviate the influence from noise. The self test reading in LSB varies with measurement range (± 2 g, ± 4 g, ± 8 g), but does not vary significantly with the operation mode (normal operation or low noise mode) and bandwidth setting (ODR).

Note that self test is most accurate in the ± 2 g range and is recommended to be used. Anything other than the ± 2 g range may be inaccurate due to the low signal levels.

OPERATION AT VOLTAGES OTHER THAN 2.0 V

The ADXL367 is tested and specified at a supply voltage of $V_S = 2.0$ V. However, the ADXL367 can be powered with a V_S as high as 3.6 V or as low as 1.1 V. Some performance parameters change as the supply voltage changes, including the supply current (see [Figure 43](#)), noise (see [Table 10](#) and [Table 2](#)), offset, sensitivity, and self test output change.

[Figure 62](#) shows the potential effect on 0 g offset at varying supply voltages. Data for [Figure 62](#) was calibrated to show 0 mg offset at 2.0 V.

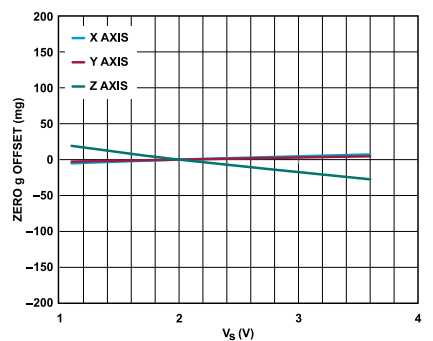

Figure 62. 0 g Offset vs. Supply Voltage (V_S)

MECHANICAL CONSIDERATIONS FOR MOUNTING

Mount the ADXL367 on the PCB in a location close to a hard mounting point of the PCB to the case. Mounting the ADXL367 at an unsupported PCB location, as shown in [Figure 63](#), can result in large, apparent measurement errors due to undamped PCB vibration. Locating the accelerometer near a hard mounting point ensures that any PCB vibration at the accelerometer is greater than the mechanical sensor resonant frequency of the accelerometer.

APPLICATIONS INFORMATION

and, therefore, effectively invisible to the accelerometer. Multiple mounting points, close to the sensor, and/or a thicker PCB also help to reduce the effect of system resonance on the performance of the sensor.

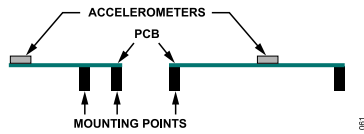

Figure 63. Incorrectly Placed Accelerometers

Layout and Design Recommendations

Figure 64 shows the recommended PCB land pattern.

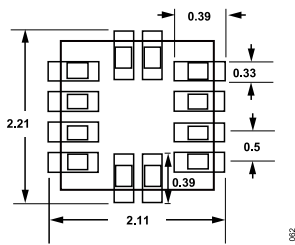

Figure 64. Recommended PCB Land Pattern

AXES OF ACCELERATION SENSITIVITY

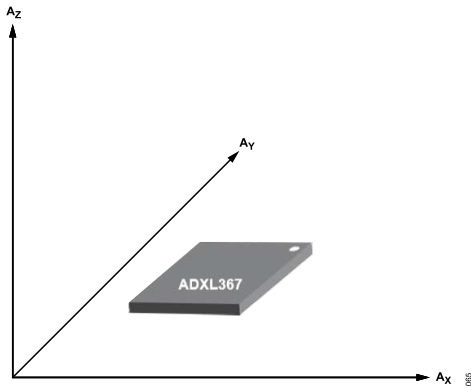

Figure 65. Axes of Acceleration Sensitivity (Corresponding Output Increases When Accelerated Along the Sensitive Axis)

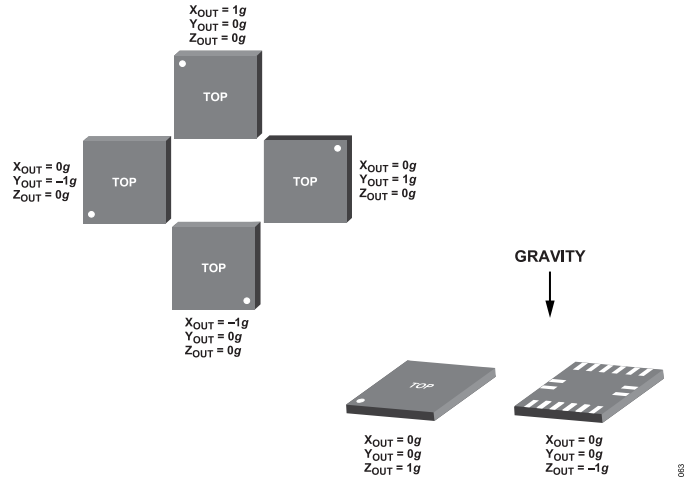

Figure 66. Output Response vs. Orientation to Gravity