

Micropower, 3-Axis,  $\pm 200\text{ g}$  Digital Output, MEMS Accelerometer

**FEATURES**

- ▶  $\pm 200\text{ g}$  measurement range
- ▶ 160 Hz to 2560 Hz user selectable bandwidth with four-pole antialiasing filter
- ▶ Selectable oversampling ratio
- ▶ Adjustable high-pass filter
- ▶ Ultra low power
  - ▶ Power can be derived from a coin cell battery
  - ▶ 28  $\mu\text{A}$  at 2560 Hz ODR, 3.3 V supply
  - ▶ Low power, wake-up mode for low  $g$  activity detection
  - ▶ 1.7  $\mu\text{A}$  instant on mode with adjustable threshold
  - ▶  $< 0.1\ \mu\text{A}$  standby mode
- ▶ Built in features for system level power savings
- ▶ Deep embedded FIFO to minimize host processor load
  - ▶ Autonomous interrupt processing without processor intervention
- ▶ Ultra low power event monitoring detects impacts and wakes up fast enough to capture the transient events
- ▶ Adjustable, low  $g$  threshold activity and inactivity detection
- ▶ Wide operating voltage range: 2.5 V to 3.5 V
- ▶ Acceleration sample synchronization via external trigger
- ▶ SPI digital interface and I<sup>2</sup>C interface format support
- ▶ 12-bit output at 100 mg/LSB scale factor
- ▶ Wide temperature range:  $-40^{\circ}\text{C}$  to  $+105^{\circ}\text{C}$
- ▶ Small, thin, 3 mm  $\times$  3.25 mm  $\times$  1.06 mm package

**APPLICATIONS**

- ▶ Impact and shock detection
- ▶ Asset health assessment
- ▶ Portable Internet of Things (IoT) edge nodes
- ▶ Concussion and head trauma detection

**FUNCTIONAL BLOCK DIAGRAM**

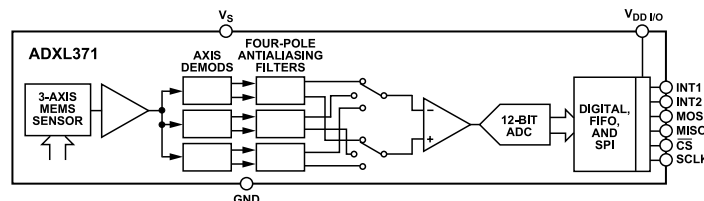

Figure 1.

**GENERAL DESCRIPTION**

The ADXL371 is an ultra low power, 3-axis,  $\pm 200\text{ g}$  microelectro-mechanical system (MEMS) accelerometer that consumes 28  $\mu\text{A}$  at a 2560 Hz output data rate (ODR). The ADXL371 does not power cycle its front end to achieve its low power operation and therefore does not run the risk of aliasing the output of the sensor.

In addition to its ultra low power consumption, the ADXL371 enables impact detection while providing system level power reduction. The device includes a deep multimode output first in, first out (FIFO), several activity detection modes, and a method for capturing only the peak acceleration of overthreshold events.

Two additional lower power modes with interrupt driven, wake-up features are available for monitoring motion during periods of inactivity. In wake-up mode, acceleration data can be averaged to obtain a low enough output noise to trigger on low  $g$  thresholds. In instant on mode, the ADXL371 consumes 1.7  $\mu\text{A}$  while continuously monitoring the environment for impacts. When an impact event that exceeds the internally set threshold is detected, the device switches to normal operating mode fast enough to record the event.

High  $g$  applications tend to experience acceleration content over a wide range of frequencies. The ADXL371 includes a four-pole, low-pass antialiasing filter to attenuate out of band signals that are common in high  $g$  applications. The ADXL371 also incorporates a high-pass filter to eliminate initial and slow changing errors, such as ambient temperature drift.

The ADXL371 provides 12-bit output data at a 100 mg/LSB scale factor. The user can access configuration and data registers via the serial peripheral interface (SPI) or I<sup>2</sup>C protocol. The ADXL371 operates over a wide supply voltage range and is available in a 3 mm  $\times$  3.25 mm  $\times$  1.06 mm package.

In this data sheet, multifunction pin names may be referenced by their relevant function only.

## TABLE OF CONTENTS

Features.....	1	Product Revision ID Register.....	32
Applications.....	1	Status Register.....	33
General Description.....	1	Activity Status Register.....	33
Functional Block Diagram.....	1	X-Axis Data Register, MSB.....	33
Specifications.....	4	X-Axis Data Register, LSB.....	34
SPI Specifications.....	5	Y-Axis Data Register, MSB.....	34
I <sup>2</sup> C Specifications.....	6	Y-Axis Data Register, LSB.....	34
Absolute Maximum Ratings.....	8	Z-Axis Data Register, MSB.....	35
Thermal Resistance.....	8	Z-Axis Data Register, LSB.....	35
Recommended Soldering Profile.....	8	Offset Trim Registers.....	35
Electrostatic Discharge (ESD) Ratings.....	8	X-Axis Offset Trim Register, LSB.....	35
ESD Caution.....	8	Y-Axis Offset Trim Register, LSB.....	35
Pin Configuration and Function Descriptions.....	9	Z-Axis Offset Trim Register, LSB.....	36
Typical Performance Characteristics.....	10	X-Axis Activity Threshold Register, MSB.....	36
Theory of Operation.....	15	X-Axis of Activity Threshold Register, LSB.....	36
Mechanical Device Operation.....	15	Y-Axis Activity Threshold Register, MSB.....	37
Operating Modes.....	15	Y-Axis of Activity Threshold Register, LSB.....	37
Bandwidth.....	15	Z-Axis Activity Threshold Register, MSB.....	37
Power/Noise Trade-Off.....	16	Z-Axis of Activity Threshold Register, LSB.....	38
Power Savings.....	16	Activity Time Register.....	38
Autonomous Event Detection.....	17	X-Axis Inactivity Threshold Register, MSB.....	38
Activity and Inactivity.....	17	X-Axis of Inactivity Threshold Register, LSB.....	39
Motion Warning.....	19	Y-Axis Inactivity Threshold Register, MSB.....	39
Impact Detection Features.....	20	Y-Axis of Inactivity Threshold Register, LSB.....	39
Wide Bandwidth.....	20	Z-Axis Inactivity Threshold Register, MSB.....	40
Instant On Impact Detection.....	20	Z-Axis of Inactivity Threshold Register, LSB.....	40
Capturing impact events.....	20	Inactivity Time Registers.....	40
FIFO.....	22	Inactivity Timer Register, MSB.....	41
Benefits of the FIFO.....	22	Inactivity Timer Register, LSB.....	41
Using the FIFO.....	22	X-Axis Motion Warning Threshold Register, MSB.....	41
Retrieving Data from FIFO.....	22	X-Axis of Motion Warning Notification Register, LSB.....	41
Interrupts.....	24	Y-Axis Motion Warning Notification Threshold Register, MSB.....	42
Interrupt Pins.....	24	Y-Axis of Motion Warning Notification Register, LSB.....	42
Types of Interrupts.....	24	Z-Axis Motion Warning Notification Threshold Register, MSB.....	43
Additional Features.....	26	Z-Axis Motion Warning Notification Register, LSB.....	43
Using an External Clock.....	26	High-Pass Filter Settings Register.....	43
Synchronized Data Sampling.....	26	FIFO Samples Register.....	44
Self Test.....	26	FIFO Control Register.....	44
User Register Protection.....	27	Interrupt Pin Function Map Registers.....	45
User Offset Trims.....	27	INT2 Function Map Register.....	45
Serial Communications.....	28	External Timing Control Register.....	46
Serial Interface.....	28	Measurement Control Register.....	47
Multibyte Transfers.....	28	Power Control Register.....	48
Invalid Addresses and Address Folding.....	28		
Register Map.....	30		
Register Details.....	32		
Analog Devices ID Register.....	32		
Analog Devices MEMS ID Register.....	32		
Device ID Register.....	32		

**TABLE OF CONTENTS**

Self Test Register.....	48	Mechanical Considerations for Mounting.....	51
RESET (Clears) Register, Part in Standby Mode.....	49	Axes of Acceleration Sensitivity.....	51
FIFO Access Register.....	49	Layout and Design Recommendations.....	52
Applications Information.....	50	Silicon Anomaly.....	53
Application Examples.....	50	ADXL371 Functionality Issues.....	53
Operation at Voltages Other than 3.3 V.....	51	Functionality Issue.....	53
Operation at Temperatures Other than Ambient.....	51	Outline Dimensions.....	54
		Ordering Guide.....	54
		Evaluation Boards.....	54

**REVISION HISTORY****10/2022—Rev. 0 to Rev. A**

Changes to Features Section.....	1
Changes to General Description Section.....	1
Moved SPI Timing Diagrams Section, Table 2, and Figure 2 to Figure 6.....	6
Moved I <sup>2</sup> C Timing Diagrams Section, Table 3, and Figure 7 to Figure 10.....	6
Changes to Wake-Up Mode Section.....	15
Changes to Power Savings Section.....	16
Added Capturing Impact Events Section, Figure 44, and Figure 45; Renumbered Sequentially.....	20
Added Limitations Section.....	21
Added FIFO Section.....	22
Added Benefits of the FIFO Section.....	22
Added Data Recording/Event Context Section.....	22
Added Using the FIFO Section.....	22
Added FIFO Disabled Section.....	22
Added Oldest Saved Mode (First N) Section.....	22
Added Stream Mode (Last N) Section.....	22
Added Triggered Mode Section.....	22
Added Retrieving Data from FIFO Section.....	22
Added Table 12 and Table 13; Renumbered Sequentially.....	23
Changes to Interrupt Pins Section.....	24
Added FIFO Interrupts Section.....	24
Added FIFO Watermark Section.....	24
Added FIFO Ready Section.....	24
Added Overrun Section and Table 14.....	25
Changed V <sub>S</sub> Supply Start-Up Threshold Section to V <sub>RESET</sub> Section.....	50
Changes to V <sub>RESET</sub> Section.....	50
Changes to Hold Time Section.....	50
Changes to Rise Time Section and Figure 51.....	50
Added Silicon Anomaly Section.....	53
Added ADXL371 Functionality Issues Section and Table 63.....	53
Added Functionality Issue Section, Table 64, and Figure 58.....	53

**3/2021—Revision 0: Initial Version**

## SPECIFICATIONS

$T_A = 25^\circ\text{C}$ ,  $V_S = 3.3\text{ V}$ ,  $V_{\text{DD}/\text{IO}} = 3.3\text{ V}$ , 2560 Hz ODR, 1280 Hz bandwidth, acceleration = 0 g, and default register settings but with high-pass filter (HPF) turned off. All minimum and maximum specifications are guaranteed. Typical specifications may not be guaranteed.

Table 1.

Parameter	Test Conditions/Comments	Min	Typ	Max	Unit
SENSOR INPUT	Each axis				
Measurement Range			±200		g
Nonlinearity	Percentage of full scale		±0.5		%
Sensor Resonant Frequency			16		kHz
Cross Axis Sensitivity <sup>1</sup>			±2.5		%
OUTPUT RESOLUTION	Each axis				
All Operating Modes			12		Bits
SCALE FACTOR	Each axis				
Scale Factor Calibration Error				±10	%
Scale Factor at $X_{\text{OUT}}$ , $Y_{\text{OUT}}$ , $Z_{\text{OUT}}$	Expressed in mg/LSB		100		mg/LSB
	Expressed in LSB/g		10		LSB/g
Scale Factor Change Due to Temperature <sup>2</sup>			0.1		%/°C
0 g OFFSET	Each axis				
0 g Output	$X_{\text{OUT}}$ , $Y_{\text{OUT}}$ , and $Z_{\text{OUT}}$ , and at 5120 Hz ODR, 2560 Hz bandwidth				
	$V_S = 3.3\text{ V}$	-3	±1	+3	g
	$2.5\text{ V} \leq V_S \leq 3.5\text{ V}$	-8	±1	+8	g
0 g Offset vs. Temperature <sup>2</sup>	$X_{\text{OUT}}$ , $Y_{\text{OUT}}$ , $Z_{\text{OUT}}$		±30		mg/°C
NOISE PERFORMANCE					
Noise Bandwidth	Each axis				
Normal Operation			6.5		mg/√Hz
Low Noise Mode			5.5		mg/√Hz
BANDWIDTH	User selectable				
ODR		320		5120	Hz
High-Pass Filter, -3 dB Corner <sup>3</sup>		0.19		24.38	Hz
Low-Pass (Antialiasing) Filter, -3 dB Corner <sup>4</sup>	Four-pole low-pass filter	160		2560	Hz
POWER SUPPLY					
Operating Voltage Range ( $V_S$ )		2.5	3.3	3.5	V
Input and Output Voltage Range ( $V_{\text{DD}/\text{IO}}$ ) <sup>5, 6</sup>		2.5	3.3	$V_S + 0.3$	V
Supply Current					
Measurement Mode	2560 Hz ODR				
Normal Operation			28		μA
Low Noise Mode			37		μA
Instant On Mode			1.7		μA
Wake-Up Mode	Varies with wake-up rate				
	At slowest wake-up rate		1		μA
Standby Mode			<0.1		μA
Power Supply Rejection Ratio (PSRR)	Source capacitance ( $C_S$ ) = 1.1 μF, input and output capacitance ( $C_{\text{IO}}$ ) = 1.1 μF, and input is 100 mV sine wave on $V_S$				
Input Frequency					
100 Hz to 1 kHz			-20		dB
1 kHz to 250 kHz			-17		dB
Turn-On Time	2560 Hz ODR				
Power-Up to Standby	$C_S = 1.1\text{ μF}$ and $C_{\text{IO}} = 1.1\text{ μF}$		6.25		ms
Measurement Mode Instruction to First Data Output <sup>7</sup>	Filter settle bit = 1		1		ms

## SPECIFICATIONS

Table 1.

Parameter	Test Conditions/Comments	Min	Typ	Max	Unit
Instant On Ultra Low Power (ULP) Monitoring to Full Bandwidth Data	Filter settle bit = 0		462.5		ms
			1.25		ms
ENVIRONMENTAL TEMPERATURE					
Operating Temperature Range		-40		+105	°C

<sup>1</sup> Cross axis sensitivity is defined as coupling between any two axes.

<sup>2</sup> The scale factor may change 0.1%/°C (typical) in the -40°C to +25°C or +25°C to +105°C temperature ranges.

<sup>3</sup> This parameter has an available corner frequency scale with the ODR setting.

<sup>4</sup> Bandwidth and ODR are set independent of each other.

<sup>5</sup> This value is limited to 3.6 V, maximum.

<sup>6</sup> The operating voltage range to all other pins (digital input/outputs (I/Os)) is limited to the absolute maximum ratings (see Table 4).

<sup>7</sup> Data output before the 5<sup>th</sup> sample may be invalid due to filter settling.

## SPI SPECIFICATIONS

$T_A = 25^\circ\text{C}$ ,  $V_S = 3.3\text{ V}$ , and  $V_{DDI/O} = 3.3\text{ V}$ , unless otherwise noted.

Table 2. SPI Logic Levels and Timing

Parameter	Description	Min	Typ	Max	Unit
INPUT DC LEVELS					
$V_{IL}$	Low level input voltage			$0.3 \times V_{DDI/O}$	V
$V_{IH}$	High level input voltage	$0.7 \times V_{DDI/O}$			V
$I_{IL}$	Low level input current, $V_{IN} = 0\text{ V}$	-0.1			μA
$I_{IH}$	High level input current, $V_{IN} = V_{DDI/O}$			0.1	μA
OUTPUT DC LEVELS					
$V_{OL}$	Low level output voltage, $I_{OL} = I_{OL, MIN}$			$0.2 \times V_{DDI/O}$	V
$V_{OH}$	High level output voltage, $I_{OL} = I_{OH, MAX}$	$0.8 \times V_{DDI/O}$			V
$I_{OL}$	Low level output current, $V_{OL} = V_{OL, MAX}$	-10			mA
$I_{OH}$	High level output current, $V_{OL} = V_{OH, MIN}$			4	mA
INPUT AC					
SCLK Frequency		0.1		10	MHz
$t_{HIGH}$	SCLK high time	40			ns
$t_{LOW}$	SCLK low time	40			ns
$t_{CSS}$	$\overline{CS}$ setup time	20			ns
$t_{CSH}$	$\overline{CS}$ hold time	20			ns
$t_{CSD}$	$\overline{CS}$ disable time	40			ns
$t_{SCLKS}$	Rising SCLK setup time	20			ns
$t_{SU}$	MOSI setup time	20			ns
$t_{HD}$	MOSI hold time	20			ns
OUTPUT AC					
$t_P$	Propagation delay, $C_{LOAD} = 30\text{ pF}$			30	ns
$t_{EN}$	Enable MISO time	30			ns
$t_{DIS}$	Disable MISO time			20	ns

SPECIFICATIONS

SPI Timing Diagrams

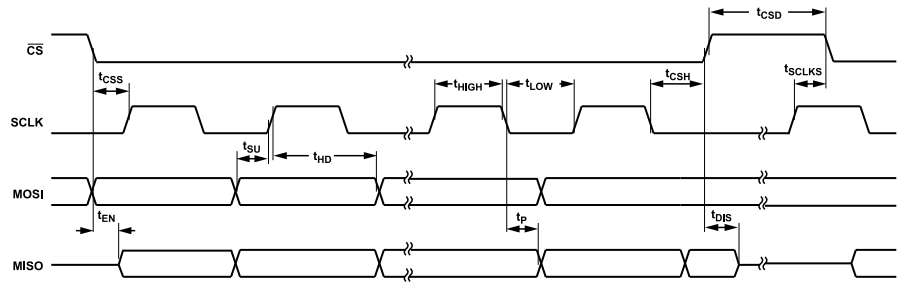

Figure 2. SPI Timing Diagram

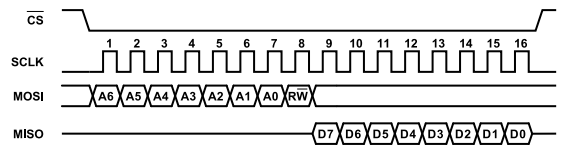

Figure 3. SPI Timing Diagram, Single-Byte Read

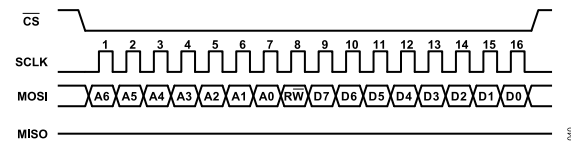

Figure 4. SPI Timing Diagram, Single-Byte Write

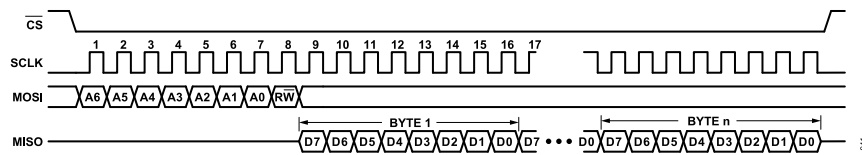

Figure 5. SPI Timing Diagram, Multibyte Read

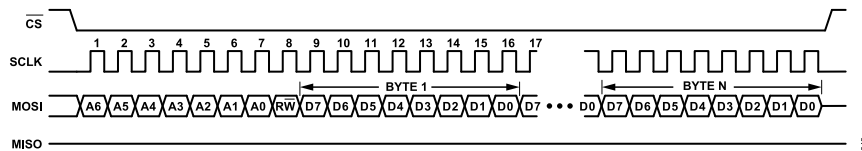

Figure 6. SPI Timing Diagram, Multibyte Write

I<sup>2</sup>C SPECIFICATIONS

T<sub>A</sub> = 25°C, V<sub>S</sub> = 3.3 V, V<sub>DDIO</sub> = 3.3 V, unless otherwise noted.

Table 3. I<sup>2</sup>C Logic Level and Timing

Parameter	Description	I2C_HSM_EN = 0			I2C_HSM_EN = 1			Unit
		Min	Typ	Max	Min	Typ	Max	
INPUT AC								
SCLK Frequency		0		1	0		3.4	MHz
t <sub>HIGH</sub>	SCLK high time	260			120			ns
t <sub>LOW</sub>	SCLK low time	500			320			ns

SPECIFICATIONS

Table 3. I<sup>2</sup>C Logic Level and Timing

Parameter	Description	I2C_HSM_EN = 0			I2C_HSM_EN = 1			Unit
		Min	Typ	Max	Min	Typ	Max	
t <sub>SUSTA</sub>	Start setup time	260			160			ns
t <sub>HDSTA</sub>	Start hold time	260			160			ns
t <sub>SUDAT</sub>	Data setup time	50			10			ns
t <sub>HDDAT</sub>	Data hold time	0			0		150	ns
t <sub>SUSTO</sub>	Stop setup time	260			160			ns
t <sub>BUF</sub>	Bus free time	500						ns
t <sub>RCL</sub>	SCL input rise time			120	20		80	ns
t <sub>FCL</sub>	SCL input fall time	20 × (V <sub>DD</sub> /5.5)		120	20		80	ns
t <sub>RDA</sub>	SDA input rise time			120	20		160	ns
t <sub>FDA</sub>	SDA input fall time	20 × (V <sub>DD</sub> /5.5)		120	20		160	ns
OUTPUT AC C <sub>LOAD</sub>				550			400	pF

I<sup>2</sup>C Timing Diagrams

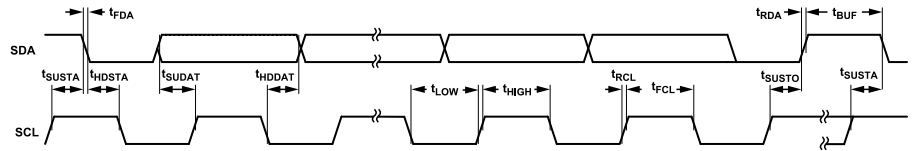

Figure 7. I<sup>2</sup>C Timing Diagram

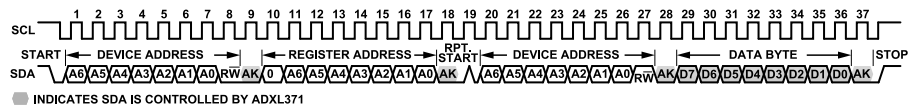

Figure 8. I<sup>2</sup>C Timing Diagram, Single-Byte Read

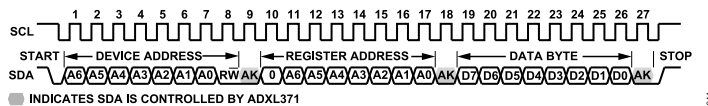

Figure 9. I<sup>2</sup>C Timing Diagram, Single-Byte Write

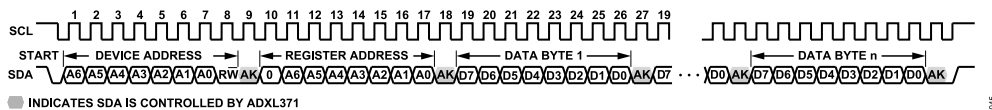

Figure 10. I<sup>2</sup>C Timing Diagram, Multibyte Write

## ABSOLUTE MAXIMUM RATINGS

Table 4.

Parameter	Rating
Acceleration	
Any Axis, Unpowered	10,000 g for 0.1 ms
Any Axis, Powered	10,000 g for 0.1 ms
$V_S$	-0.3 V to +3.6 V
$V_{DDIO}$	-0.3 V to +3.6 V
All Other Pins <sup>1</sup>	-0.3 V to $V_{DDIO} + 0.3$ V
Output Short-Circuit Duration (Any Pin to Ground)	Indefinite
Temperature Range	
Storage	-50°C to +150°C
Powered	-40°C to +125°C

<sup>1</sup> This value is limited to 3.6 V, maximum.

Stresses at or above those listed under Absolute Maximum Ratings may cause permanent damage to the product. This is a stress rating only; functional operation of the product at these or any other conditions above those indicated in the operational section of this specification is not implied. Operation beyond the maximum operating conditions for extended periods may affect product reliability.

## THERMAL RESISTANCE

Thermal performance is directly linked to printed circuit board (PCB) design and operating environment. Careful attention to PCB thermal design is required.

$\theta_{JA}$  is the natural convection, junction to ambient thermal resistance measured in a one cubic foot sealed enclosure.  $\theta_{JC}$  is the junction to case thermal resistance.

Table 5.

Package Type <sup>1</sup>	$\theta_{JA}$	$\theta_{JC}$	Unit	Device Weight
CC-16-4	150	85	°C/W	18 mg

<sup>1</sup> Thermal impedance simulated values are based on a JEDEC 2S2P thermal test board with four thermal vias. See JEDEC JESD51.

## RECOMMENDED SOLDERING PROFILE

Figure 11 and Table 6 provide details about the recommended soldering profile.

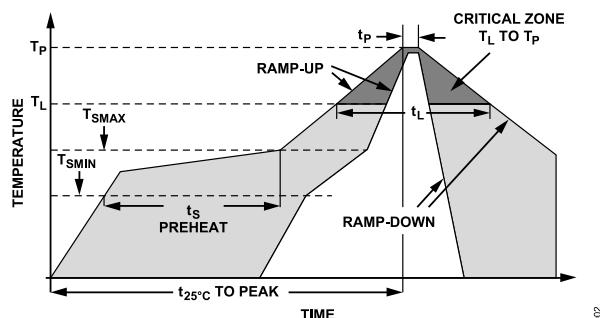

Figure 11. Recommended Soldering Profile

Table 6. Recommended Soldering Profile

Profile Feature	Condition	
	Sn63/Pb37	Pb-Free
Average Ramp Rate ( $T_L$ to $T_P$ )	3°C/sec max	3°C/sec max
Preheat		
Minimum Temperature ( $T_{SMIN}$ )	100°C	150°C
Maximum Temperature ( $T_{SMAX}$ )	150°C	200°C
Time ( $T_{SMIN}$ to $T_{SMAX}$ ) ( $t_S$ )	60 sec to 120 sec	60 sec to 180 sec
$T_{SMAX}$ to $T_L$ Ramp-Up Rate	3°C/sec max	3°C/sec max
Time Maintained Above Liquidous ( $T_L$ )		
Liquidous Temperature ( $T_L$ )	183°C	217°C
Time ( $t_L$ )	60 sec to 150 sec	60 sec to 150 sec
Peak Temperature ( $T_P$ )	240 + 0/-5°C	260 + 0/-5°C
Time Within 5°C of Actual Peak Temperature ( $t_P$ )	10 sec to 30 sec	20 sec to 40 sec
Ramp-Down Rate	6°C/sec max	6°C/sec max
Time 25°C to $T_P$	6 min max	8 min max

## ELECTROSTATIC DISCHARGE (ESD) RATINGS

The following ESD information is provided for handling of ESD-sensitive devices in an ESD protected area only.

Human body model (HBM) per ANSI/ESDA/JEDEC JS-001.

## ESD Ratings for ADXL371

Table 7. ADXL371, 16-Terminal LGA

ESD Model	Withstand Threshold (V)	Class
HBM	2000	1C

## ESD CAUTION



**ESD (electrostatic discharge) sensitive device.** Charged devices and circuit boards can discharge without detection. Although this product features patented or proprietary protection circuitry, damage may occur on devices subjected to high energy ESD. Therefore, proper ESD precautions should be taken to avoid performance degradation or loss of functionality.



## PIN CONFIGURATION AND FUNCTION DESCRIPTIONS

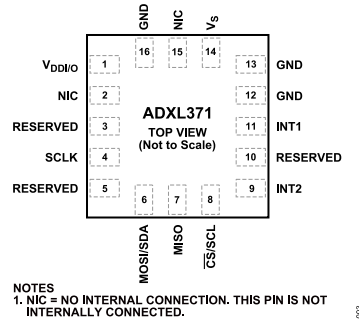

Figure 12. Pin Configuration (Top View)

Table 8. Pin Function Descriptions

Pin No.	Mnemonic	Description
1	V <sub>DDIO</sub>	Supply Voltage for Digital Input and Output.
2	NIC	No Internal Connection. This pin is not internally connected.
3	RESERVED	Reserved. This pin can be left unconnected or connected to GND.
4	SCLK	SPI Serial Communications Clock.
5	RESERVED	Reserved. This pin can be left unconnected or connected to GND.
6	MOSI/SDA	SPI Master Output, Slave Input (MOSI). I <sup>2</sup> C Serial Data (SDA).
7	MISO	SPI Master Input, Slave Output.
8	$\overline{\text{CS}}$ /SCL	SPI Chip Select ( $\overline{\text{CS}}$ ). I <sup>2</sup> C Serial Communications Clock (SCL).
9	INT2	Interrupt 2 Output. This pin also serves as an input for synchronized sampling.
10	RESERVED	Reserved. This pin can be left unconnected or connected to GND.
11	INT1	Interrupt 1 Output. This pin also serves as an input for external clocking.
12	GND	Ground. This pin must be connected to ground.
13	GND	Ground. This pin must be connected to ground.
14	V <sub>S</sub>	Supply Voltage.
15	NIC	No Internal Connection. This pin is not internally connected.
16	GND	Ground. This pin must be connected to ground.

TYPICAL PERFORMANCE CHARACTERISTICS

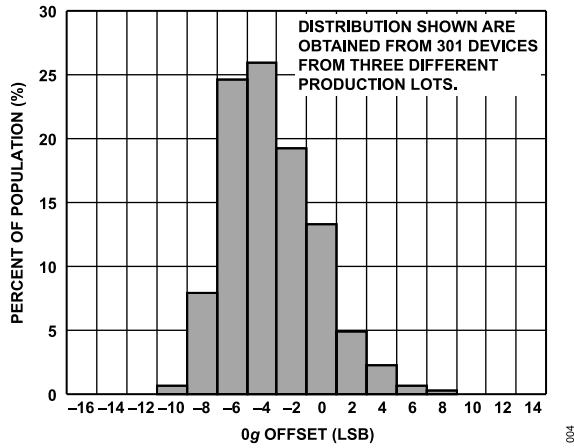

Figure 13. X-Axis 0 g Offset (LSB) at 25°C,  $V_S = 3.3 V$

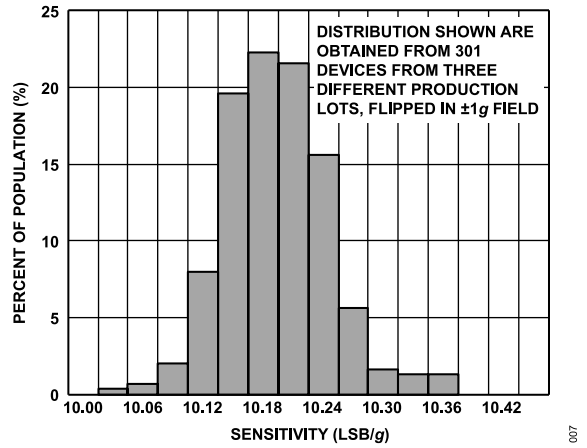

Figure 16. X-Axis Sensitivity at 25°C,  $V_S = 3.3 V$

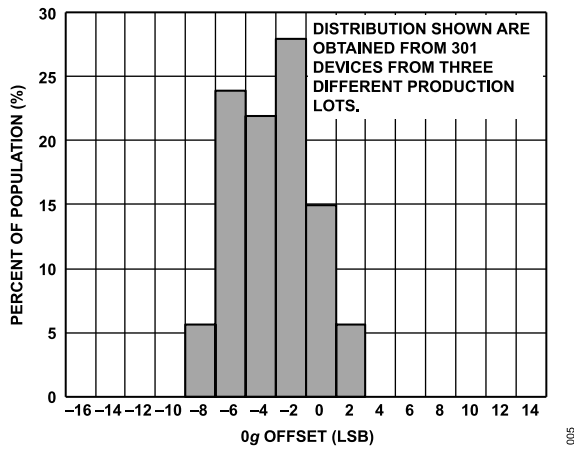

Figure 14. Y-Axis 0 g Offset (LSB) at 25°C,  $V_S = 3.3 V$

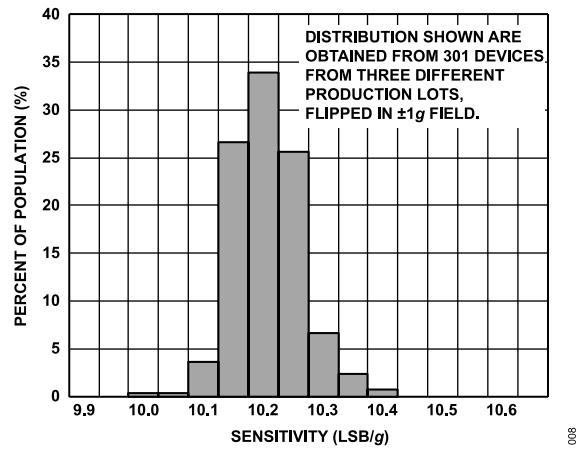

Figure 17. Y-Axis Sensitivity at 25°C,  $V_S = 3.3 V$

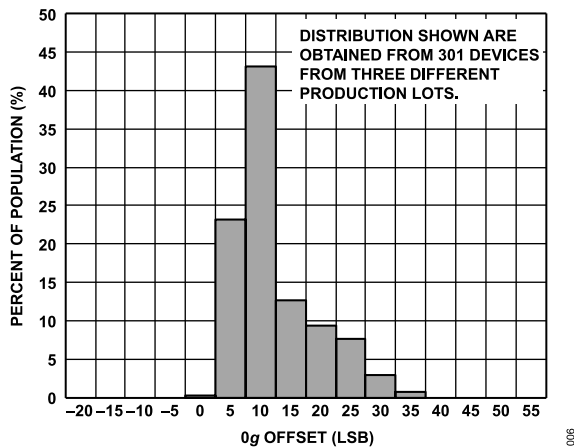

Figure 15. Z-Axis 1 g Offset (LSB) at 25°C,  $V_S = 3.3 V$

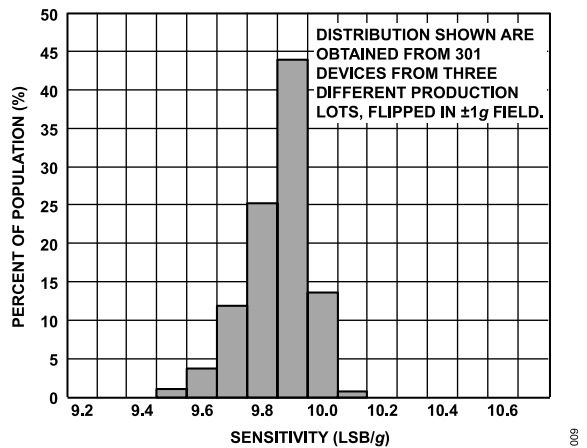

Figure 18. Z-Axis Sensitivity at 25°C,  $V_S = 3.3 V$

TYPICAL PERFORMANCE CHARACTERISTICS

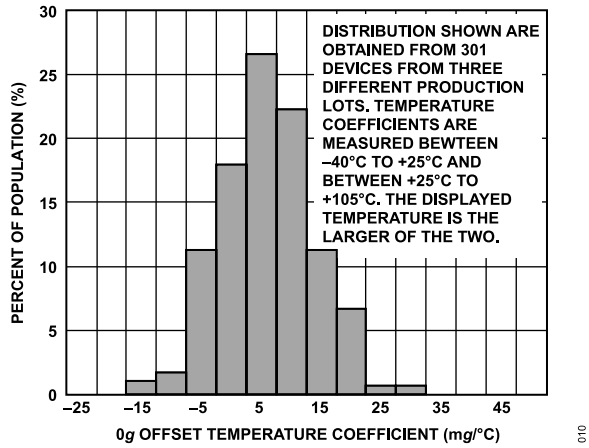

Figure 19. X-Axis 0 g Offset Temperature Coefficient (mg/°C),  $V_S = 3.3\text{ V}$

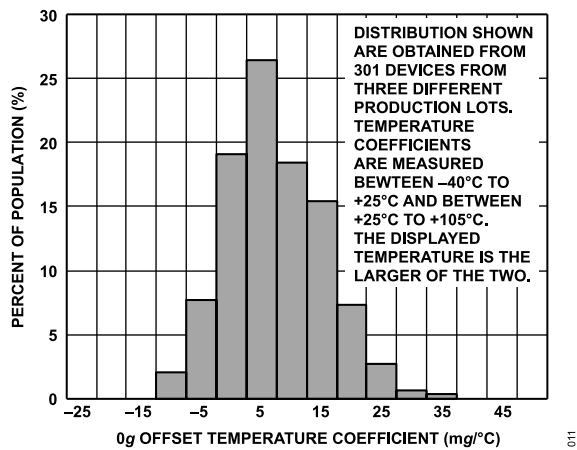

Figure 20. Y-Axis 0 g Offset Temperature Coefficient (mg/°C),  $V_S = 3.3\text{ V}$

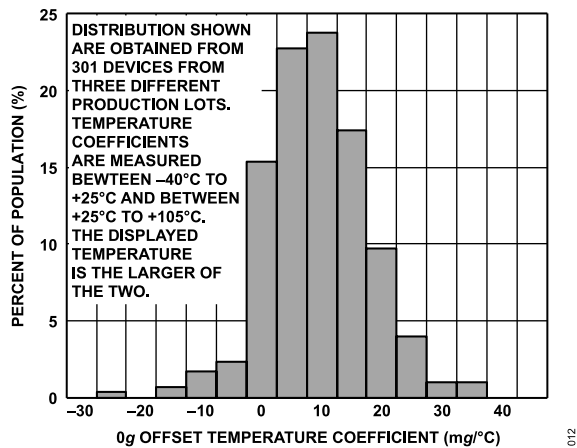

Figure 21. Z-Axis 0 g Offset Temperature Coefficient,  $V_S = 3.3\text{ V}$

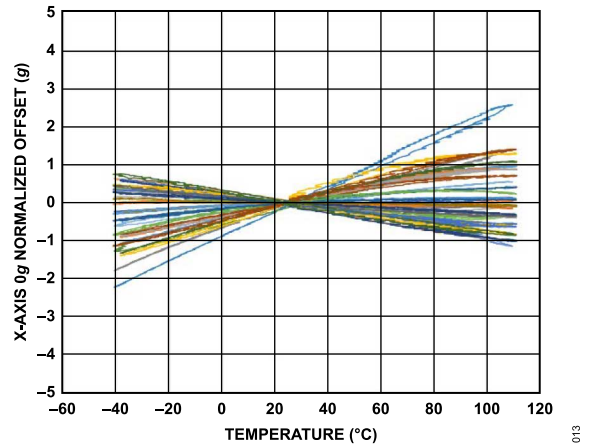

Figure 22. X-Axis 0 g Normalized Offset vs. Temperature, 36 Devices Soldered to PCB, ODR = 2560 Hz

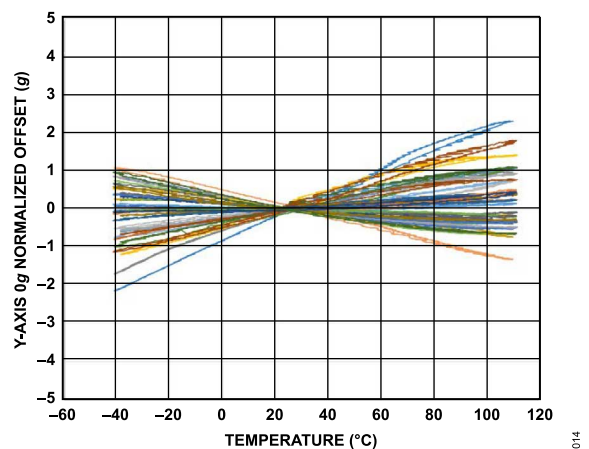

Figure 23. Y-Axis 0 g Normalized Offset vs. Temperature, 36 Devices Soldered to PCB, ODR = 2560 Hz

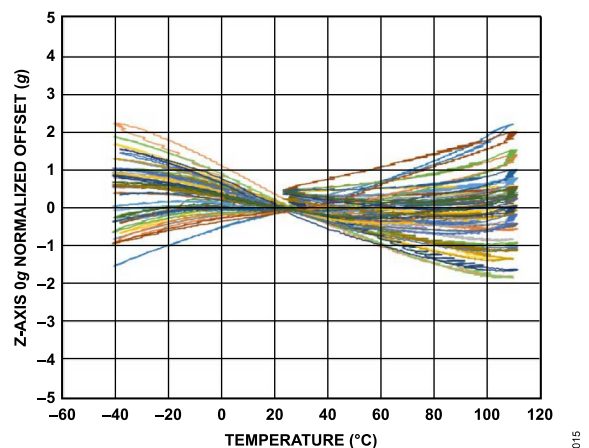

Figure 24. Z-Axis 0 g Normalized Offset vs. Temperature, 36 Devices Soldered to PCB, ODR = 2560 Hz

TYPICAL PERFORMANCE CHARACTERISTICS

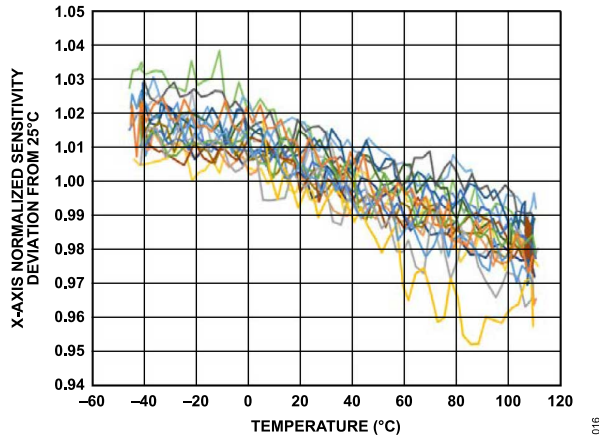

Figure 25. X-Axis Normalized Sensitivity Deviation from 25°C vs. Temperature, 18 Devices Soldered to PCB, ODR = 2560 Hz

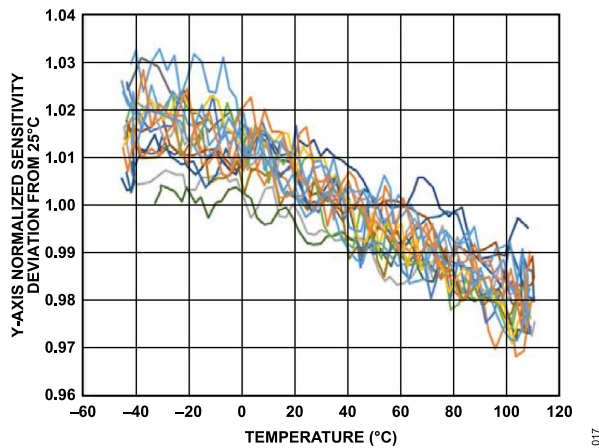

Figure 26. Y-Axis Normalized Sensitivity Deviation from 25°C vs. Temperature, 17 Devices Soldered to PCB, ODR = 2560 Hz

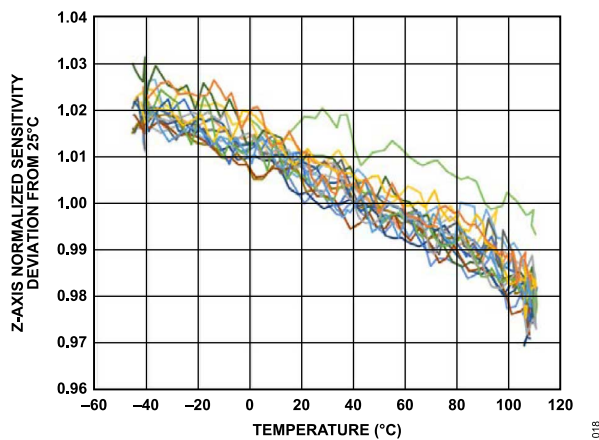

Figure 27. Z-Axis Normalized Sensitivity Deviation from 25°C vs. Temperature, 18 Devices Soldered to PCB, ODR = 2560 Hz

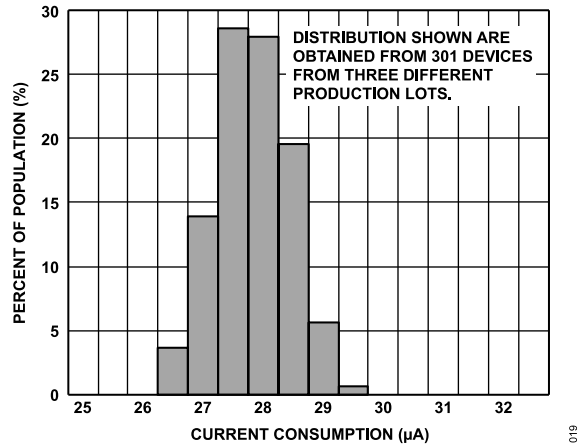

Figure 28. Current Consumption at 25°C, Normal Mode, 2560 Hz Output Data Rate,  $V_S = 3.3\text{ V}$

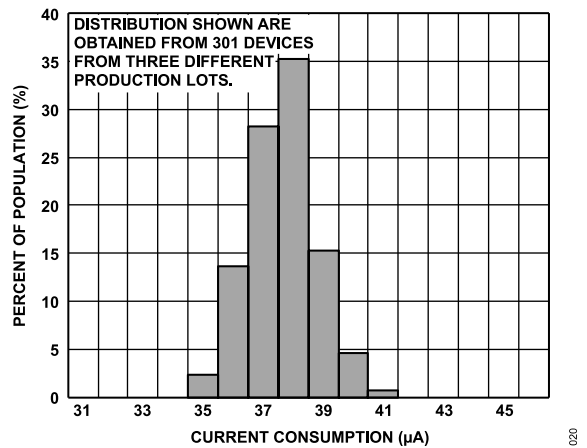

Figure 29. Current Consumption at 25°C, Low Noise Mode, 2560 Hz Output Data Rate,  $V_S = 3.3\text{ V}$

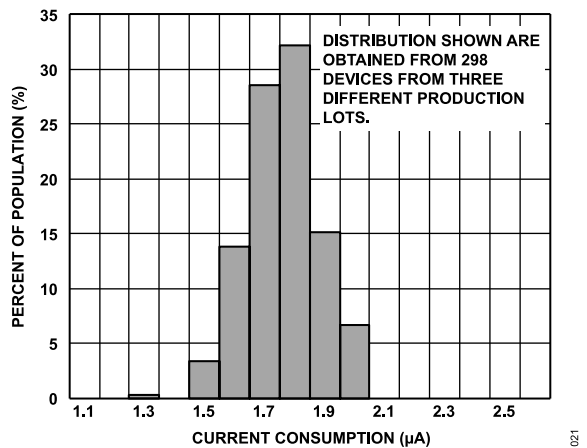

Figure 30. Current Consumption at 25°C, Instant On Mode,  $V_S = 3.3\text{ V}$

TYPICAL PERFORMANCE CHARACTERISTICS

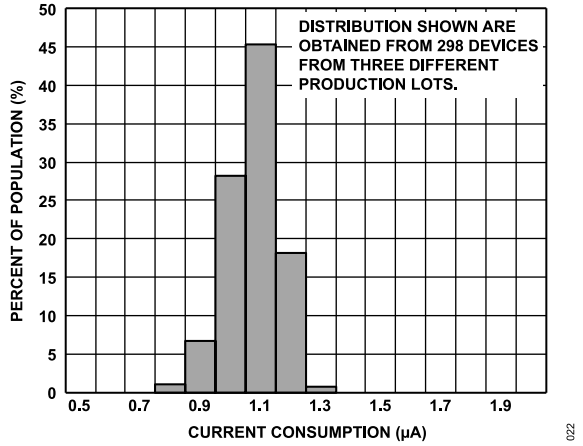

Figure 31. Current Consumption at 25°C, Wake-Up Mode,  $V_S = 3.3\text{ V}$

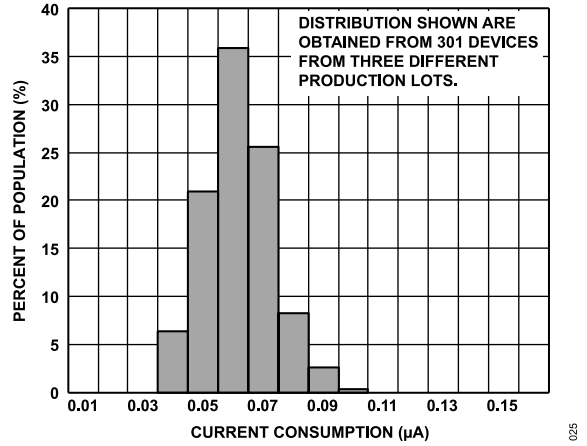

Figure 34. Current Consumption at 25°C, Standby Mode,  $V_S = 3.3\text{ V}$

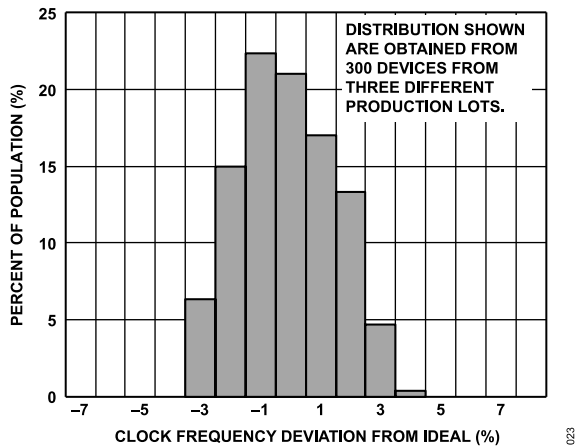

Figure 32. Clock Frequency Deviation from Ideal at 25°C, ODR = 2560 Hz,  $V_S = 3.3\text{ V}$

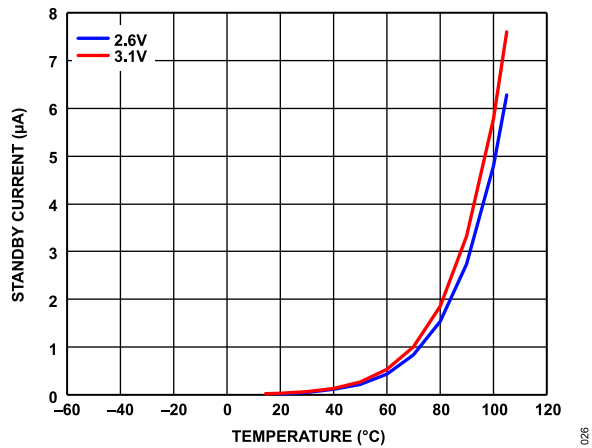

Figure 35. Standby Current vs. Temperature

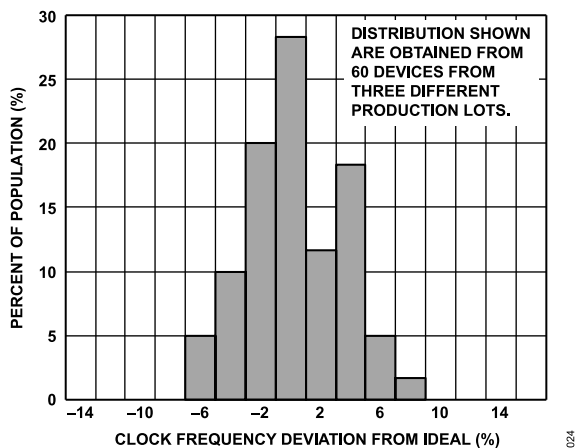

Figure 33. Clock Frequency Deviation from Ideal at 25°C, ODR = 5120 Hz,  $V_S = 3.3\text{ V}$

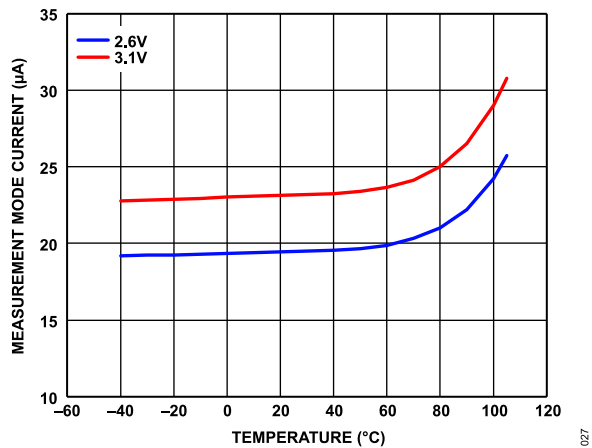

Figure 36. Measurement Mode Current vs. Temperature

TYPICAL PERFORMANCE CHARACTERISTICS

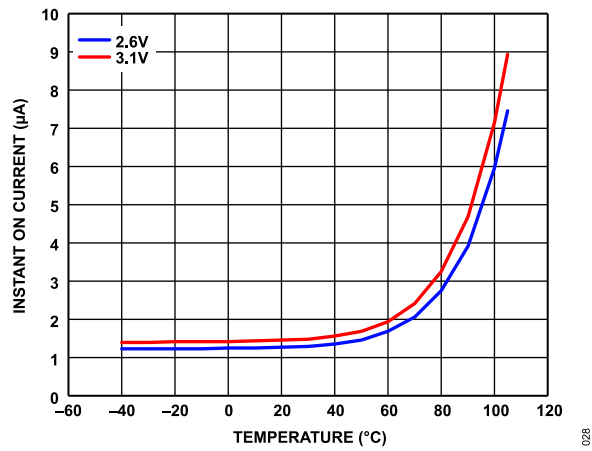

Figure 37. Instant On Current vs. Temperature

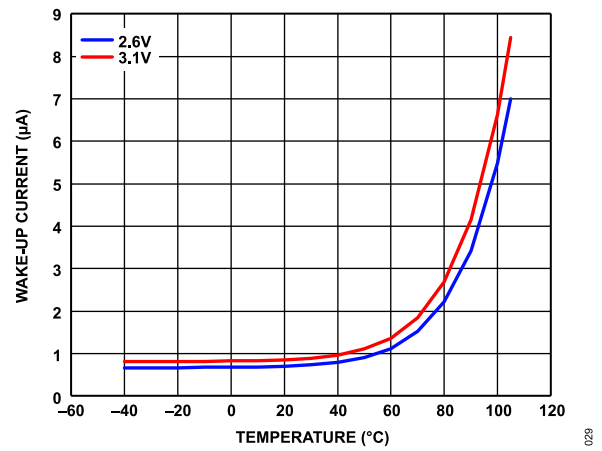

Figure 38. Wake-Up Current vs. Temperature

## THEORY OF OPERATION

The ADXL371 is a complete 3-axis acceleration measurement system that operates at extremely low power levels. Acceleration is reported digitally, and the device communicates via the SPI and I<sup>2</sup>C protocols. Built in digital logic enables autonomous operation and implements functions that enhance system level power savings.

### MECHANICAL DEVICE OPERATION

The moving component of the sensor is a polysilicon surface micromachined structure built on top of a silicon wafer. Polysilicon springs suspend the structure over the surface of the wafer and provide a resistance against acceleration forces.

Deflection of the structure is measured using differential capacitors that consist of independent fixed plates and plates attached to the moving mass. Acceleration deflects the structure and unbalances the differential capacitor, resulting in a sensor output whose amplitude is proportional to acceleration. Phase sensitive demodulation determines the magnitude and polarity of the acceleration.

### OPERATING MODES

The ADXL371 has three operating modes: a measurement mode for continuous, wide bandwidth sensing, an instant on mode for low power impact detection, and a wake-up mode for limited bandwidth, low *g* activity detection. Measurement can be suspended by placing the device in standby mode.

#### Measurement Mode

Measurement mode is the default operating mode of the ADXL371. In this mode, acceleration data is read continuously, and the accelerometer consumes 28  $\mu\text{A}$  (typical) at an ODR of 2560 Hz when using a 3.3 V supply. Actual current consumption is dependent on the ODR chosen. All features described in this data sheet are available when operating the ADXL371 in this mode. After entering measurement mode, the first output value does not appear until after the filter settling time has passed. This time is selectable using the FILTER\_SETTLE bit in the POWER\_CTL register. See the [Filter Settling Time](#) section for more details.

#### Instant On Mode

Instant on mode enables extremely low power impact detection. In this mode, the accelerometer constantly monitors the environment while consuming a low current of 1.7  $\mu\text{A}$  (typical). When an event that exceeds an internal threshold is detected, the device switches into measurement mode to record the event. The target default threshold is 10 *g* to 15 *g*, but it can vary. A register option allows the threshold to be increased to a target of 30 *g* to 40 *g* if the default threshold is too low.

To save power, no new digital acceleration data is made available until the accelerometer switches into normal operation. However, all registers have normal read and write functionality.

### Wake-Up Mode

Wake-up mode is ideal for simple detection of the presence or absence of motion at an extremely low power consumption. Wake-up mode is particularly useful for the implementation of a low *g* motion activated on and off switch, allowing the rest of the system to be powered down until sustained activity is detected.

In wake-up mode, the device is powered down for a duration of time equal to the wake-up timer, set by the WAKEUP\_RATE bits in the TIMING register, and then turns on for a duration equal to the filter settling time (see the [Filter Settling Time](#) section). The current drawn in this mode is determined by both of these parameters.

**Table 9. Wake-Up Current in  $\mu\text{A}$  at Different Wake-Up Timer and Filter Settings**

Wake-Up Timer (ms)	Filter Settling Time	
	20 ms	462.5 ms
65	1.3 $\mu\text{A}$	16.7 $\mu\text{A}$
130	0.98 $\mu\text{A}$	15 $\mu\text{A}$
260	0.84 $\mu\text{A}$	12.4 $\mu\text{A}$
640	0.76 $\mu\text{A}$	8.4 $\mu\text{A}$
2560	0.71 $\mu\text{A}$	3.5 $\mu\text{A}$
5120	0.71 $\mu\text{A}$	2.2 $\mu\text{A}$
10,240	0.7 $\mu\text{A}$	1.5 $\mu\text{A}$
30,720	0.7 $\mu\text{A}$	1 $\mu\text{A}$

If motion is detected, the accelerometer can respond autonomously in several ways, depending on the device configuration, including the following:

- ▶ Switch into full bandwidth measurement mode
- ▶ Signal an interrupt to a microcontroller
- ▶ Wake up downstream circuitry

While in wake-up mode, all registers and the FIFO have normal read and write functionality, and real-time data can be read from the data registers at the reduced wake-up rate. However, no new data is stored in the FIFO during wake-up mode, and there are no interrupts available in wake-up mode.

### Standby

Placing the ADXL371 in standby mode suspends measurement and reduces current consumption to less than 100 nA. All interrupts are cleared, and no new interrupts are generated. The ADXL371 powers up in standby mode with all sensor functions turned off.

## BANDWIDTH

### Low-Pass Antialiasing Filter

High *g* events often include acceleration content over a wide range of frequencies. The analog-to-digital converter (ADC) of the ADXL371 samples the input acceleration at the user selected ODR. In the absence of antialiasing filters, input signals whose frequency

## THEORY OF OPERATION

is more than half the ODR alias or that fold into the measurement bandwidth can lead to inaccurate measurements. To mitigate this inaccuracy, a four-pole, low-pass filter is provided at the input of the ADC. The filter bandwidth is user selectable, and the default bandwidth is 160 Hz. The maximum bandwidth is constrained to at most half of the ODR, to ensure that the Nyquist criteria is not violated.

### High-Pass Filter

The ADXL371 offers a one-pole, high-pass filter with a user selectable  $-3$  dB frequency. Applications that do not require dc acceleration measurements can use the high-pass filter to minimize constant or slow varying offset errors including initial bias, bias drift due to temperature, and bias drift due to supply voltage.

The high-pass filter is a first-order infinite impulse response (IIR) filter. Table 10 lists the available  $-3$  dB frequencies, which are user selectable and dependent on the output data rate. The high-pass and low-pass filters can be used simultaneously to set up a band-pass option.

**Table 10. High-Pass Filter  $-3$  dB Corner Frequencies**

Setting	ODR (Hz)				
	5120	2560	1280	640	320
00	24.38	12.19	6.09	3.05	1.52
01	12.46	6.23	3.11	1.55	0.78
10	6.30	3.15	1.58	0.78	0.39
11	3.17	1.58	0.79	0.39	0.19

### Filter Settling Time

After entering measurement mode, the first output value does not appear until after the filter settling time has passed. This time is selectable using the FILTER\_SETTLE bit in the POWER\_CTL register. The recommended (and default) settling time to acquire valid data when using either the high-pass filter or the low-pass activity detect filter is 462.5 ms. The filter settling time of 20 ms is ideal for when both the high-pass filter and low-pass activity detect filter are disabled.

### Selectable ODR

The ADXL371 can report acceleration data at 320 Hz, 640 Hz, 1280 Hz, 2560 Hz, or 5120 Hz. The ODR is user selectable, and the default is 320 Hz. If the user selects an antialiasing filter bandwidth greater than half the ODR, the device defaults the bandwidth to 50% of the ODR. Increasing or decreasing the ODR increases or decreases the current consumption, accordingly, as shown in Figure 39.

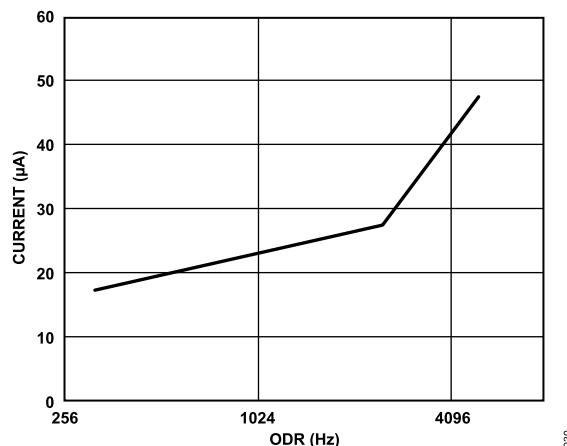

**Figure 39. Typical Measurement Mode Current vs. ODR**

## POWER/NOISE TRADE-OFF

The noise performance of the ADXL371 in normal operation, typically 6.5 mg/√Hz at 2560 Hz ODR and 1280 Hz bandwidth, is adequate for most applications, depending on bandwidth and the desired resolution. For cases where lower noise is needed, the ADXL371 provides a lower noise operating mode that trades reduced noise for a somewhat higher current consumption. In all cases, operating at a higher bandwidth setting increases the rms noise and operating at a lower bandwidth settling decreases the rms noise. Table 11 lists the current consumption and noise densities obtained for normal operation and the lower noise mode at a typical 3.3 V supply.

**Table 11. Noise and Current Consumption for  $V_S = 3.3$  V**

Mode	Typical Noise Bandwidth (mg/√Hz)	Typical Current Consumption (µA)
Normal Operation <sup>1</sup>	6.5	28
Low Noise <sup>1</sup>	5.5	37

<sup>1</sup>  $V_S = 3.3$  V, ODR = 2560 Hz, and bandwidth = 1280 Hz.

## POWER SAVINGS

The digital interface of the ADXL371 is implemented with system level power savings in mind. The following features enhance power savings:

- ▶ Burst reads and writes reduce the number of SPI communication cycles required to configure the device and retrieve data.
- ▶ Concurrent operation of activity and inactivity detection enables set it and forget it operation. Loop modes further reduce communications power by enabling the clearing of interrupts without processor intervention.
- ▶ The FIFO is implemented such that consecutive samples can be read continuously via a multibyte read of unlimited length. Thus, one FIFO read instruction can clear the entire contents of the FIFO. The ADXL371 FIFO construction also allows the use of direct memory access (DMA) to read the FIFO contents.



## AUTONOMOUS EVENT DETECTION

### ACTIVITY AND INACTIVITY

The ADXL371 features built in logic that detects activity (acceleration more than a user set threshold) and inactivity (acceleration less than a user set threshold). Activity and inactivity events can be used as triggers to manage the accelerometer operating mode, trigger an interrupt to a host processor, and/or autonomously drive a motion switch.

Detection of an activity or inactivity event is indicated in the STATUS2 register and can be configured to generate an interrupt. In addition, the activity status of the device, that is, whether it is moving or stationary, is indicated by the AWAKE bit (STATUS register), described in the [Using the AWAKE Bit](#) section.

Activity and inactivity detection can be used when the accelerometer is in either measurement mode or wake-up mode. However, the activity and inactivity interrupts are not available in wake-up mode because the device is inherently looking for activity in this mode, and any changes to the activity or inactivity detection features must be made while the device is in standby mode.

### Low-Pass Activity Detect Filter

The ADXL371 combines high *g* impact detection and low *g* movement detection in one device. For low *g* detection, an internal low-pass filter with a -3 dB corner of approximately 8 Hz averages data to reduce the rms noise, allowing accurate detection of activity or inactivity thresholds as low as 500 mg. For high *g* impact detection, the low-pass activity detect filter can be turned off through a register setting. When using both the low-pass activity detect filter and the high-pass filter, the user must select a high-pass filter corner that does not exceed 8 Hz. Otherwise, activity detection data is severely attenuated.

### Activity Detection

An activity event is detected when acceleration in at least one enabled axis remains above a specified threshold for a specified time. Enabled axes, thresholds, and time are user selected. Each axis has its own activity threshold, but the activity timer is shared among all three axes. When multiple axes are selected, an over-threshold event on any one enabled axis triggers the activity detection.

### Referenced and Absolute Configurations

Activity detection can be configured as referenced or absolute mode for all axes through the ACT\_REF bit in the THRESH\_ACT\_X\_L register.

When using absolute activity detection, acceleration samples are compared directly to a user set threshold to determine whether motion is present. For example, if a threshold of 0.5 *g* is set and the acceleration on the z-axis is 1 *g* longer than the user defined activity time, the activity status asserts.

In many applications, it is advantageous for activity detection to be based not on an absolute threshold but on a deviation from

a reference point or orientation. The referenced activity detection is particularly useful because it removes the effect on activity detection of the static 1 *g* imposed by gravity as well as any static offset errors, which can be up to several *g*. In absolute activity detection, when the threshold is set to less than 1 *g*, activity is immediately detected in this case.

In the referenced configuration, activity is detected when acceleration samples are more than an internally defined reference by a user defined amount for the user defined amount of time, as described by

$$Abs(Acceleration - Reference) > Threshold$$

where *Abs* is the absolute value.

Consequently, activity is detected only when the acceleration has deviated sufficiently from the initial orientation. The default setting for the accelerometer is in absolute mode. After it is placed in referenced mode through the appropriate register setting, the reference for activity detection is calculated as soon as the full bandwidth measurement mode is turned on. To reset the reference, it is necessary to put the device back into absolute mode and then back into referenced mode. The new reference is set as soon as the device enters full bandwidth measurement mode again. If using both activity and inactivity detection in referenced mode, both must be set back to absolute mode before the reference can be reset.

### Activity Timer

Ideally, the intent of activity detection is to wake up a system only when motion is intentional, ignoring noise or small, unintentional movements. In addition to being sensitive to low *g* events, the ADXL371 activity detection algorithm is robust in filtering out undesired triggers.

The ADXL371 activity detection functionality includes a timer to filter out unwanted motion and ensure that only sustained motion is recognized as activity. The timer period depends on the ODR selected. At 2560 Hz and under, it is approximately 8.25 ms, and at 5120 Hz, it is approximately 2.06 ms. For activity detection to trigger, above threshold activity must be sustained for a time equal to the number of activity timer periods specified in the activity time register. For example, a setting of 10 in this register means that above threshold activity must be sustained for 82.5 ms at 2560 Hz ODR. A register value of zero results in single sample activity detection. The maximum allowable activity time is approximately 2.1 sec (or 0.53 sec at 5120 Hz ODR). Note that the activity timer is operational in measurement mode only.

### Activity Detection in Wake-Up Mode

If activity detection is enabled while the device is in wake-up mode, the device uses single sample activity detection, no matter the activity time register setting. If activity is detected, the device automatically returns to full bandwidth measurement mode. However, the activity interrupt is not generated unless the activity time setting

## AUTONOMOUS EVENT DETECTION

is zero. If it is not zero, after entering measurement mode, the interrupt is not generated until the device sees sustained activity for the amount of time given in the activity time register. The awake interrupt automatically goes high upon entering measurement mode if the device is in default mode or autosleep mode. If it is in linked or loop mode (but not autosleep), it is linked to the activity interrupt, which behaves as previously mentioned.

After the device automatically enters measurement mode due to activity detection, if autosleep is not on, it must be placed manually back into wake-up mode.

### Inactivity Detection

An inactivity event is detected when acceleration in all enabled axes remains less than a specified threshold for a specified time. Enabled axes, threshold, and time are user selected. Each axis has its own inactivity threshold, but the inactivity timer is shared among all three axes. When multiple axes are selected, all enabled axes must stay less than the threshold for the required amount of time to trigger inactivity detection.

### Referenced and Absolute Configurations

Inactivity detection is also configurable as referenced or absolute through the INACT\_REF bit in the THRESH\_INACT\_X\_L register. When using absolute inactivity detection, acceleration samples are compared directly to a user set threshold for the user set time to determine the absence of motion. Inactivity is detected when enough consecutive samples are all less than the threshold.

When using referenced inactivity detection, inactivity is detected when acceleration samples are within a user specified amount from an internally defined reference for a user defined amount of time.

$$\text{Abs}(\text{Acceleration} - \text{Reference}) < \text{Threshold}$$

Referenced inactivity, like referenced activity, is particularly useful for eliminating the effects of the static acceleration due to gravity, as well as other static offsets. With absolute inactivity, if the inactivity threshold is set lower than 1 g, a device resting motionless may never detect inactivity. With referenced inactivity, the same device under the same configuration detects inactivity. The default setting for the accelerometer is in absolute mode. After it is placed in referenced mode through the appropriate register setting, the reference for inactivity detection is calculated as soon as full bandwidth measurement mode is turned on. To reset the reference, it is necessary to put the device back into absolute mode and then back into referenced mode. The new reference is set as soon as the device enters full bandwidth measurement mode again. If using both inactivity and activity detection in referenced mode, both must be set back to absolute mode before the reference can be reset.

### Inactivity Timer

The ADXL371 inactivity detect functionality includes a timer to allow detection of sustained inactivity. The timer period depends on the

ODR selected. At 2560 Hz and under, it is approximately 32.5 ms regardless of ODR. For inactivity detection to trigger, under threshold inactivity must be sustained for a time equal to the number of inactivity timer periods specified in the inactivity time registers. For example, a setting of 10 in these registers means that under threshold inactivity must be sustained for 325 ms. A value of zero in these registers results in single sample, inactivity detection. The maximum allowable inactivity time is approximately 35.5 minutes.

### Linking Activity and Inactivity Detection

When in measurement mode or wake-up mode, the activity and inactivity detection functions can be used concurrently and processed manually by a host processor, or these functions can be configured to interact in several other ways, such as those described in the following sections.

### Default Mode

In default mode, activity and inactivity detection are both available simultaneously, and all interrupts must be serviced by a host processor. That is, a processor must read each interrupt before it is cleared and can be used again. Refer to the [Interrupts](#) section for information on clearing interrupts.

The flowchart in [Figure 40](#) illustrates default mode operation.

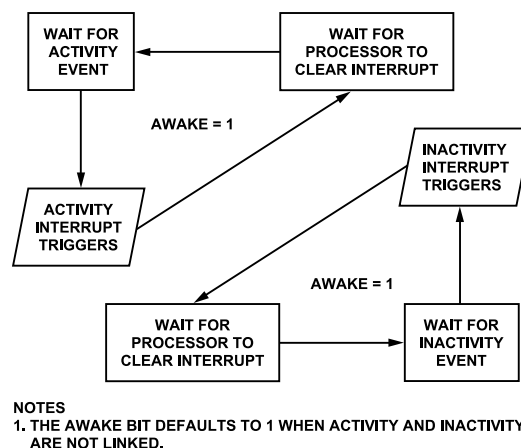

Figure 40. Flowchart Illustrating Activity and Inactivity Operation in Default Mode

### Linked Mode

In linked mode, activity and inactivity detection are linked to each other so that only one of the functions is enabled at any given time. As soon as activity is detected, the device is assumed to be moving (or awake) and stops looking for activity. Rather, inactivity is expected as the next event. Therefore, only inactivity detection operates.

Similarly, when inactivity is detected, the device is assumed to be stationary (or asleep). Thus, activity is expected as the next event. Therefore, only activity detection operates.

## AUTONOMOUS EVENT DETECTION

In linked mode, each interrupt must be serviced by a host processor before the next interrupt is enabled.

The flowchart in [Figure 41](#) illustrates linked mode operation.

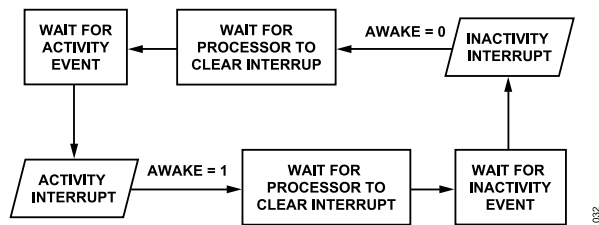
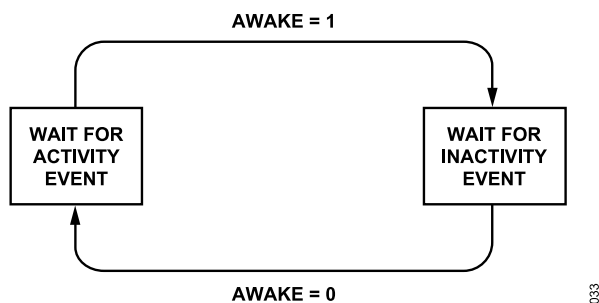

**Figure 41. Flowchart Illustrating Activity and Inactivity Operation in Linked Mode**

### Loop Mode

In loop mode, motion detection operates as described in the [Linked Mode](#) section, but interrupts do not need to be serviced by a host processor. This configuration simplifies the implementation of commonly used motion detection and enhances power savings by reducing the amount of power used in bus communication.

The flowchart in [Figure 42](#) illustrates loop mode operation.



**Figure 42. Flowchart Illustrating Activity and Inactivity Operation in Loop Mode**

### Autosleep

If autosleep is selected, after the device is placed in wake-up mode (see the [Wake-Up Mode](#) section), it automatically sets to loop mode and begins looking for activity. When activity is detected, the device automatically enters measurement mode and immediately begins looking for inactivity. When inactivity is detected, the device automatically re-enters wake-up mode. Note that the device must be manually placed in wake-up mode before autosleep can begin functioning. It does not automatically enter wake-up mode if the device is started up manually in measurement mode.

### Using the AWAKE Bit

The AWAKE bit is a status bit that indicates whether the ADXL371 is awake or asleep. In default mode or autosleep mode, the AWAKE bit is high whenever the device is in measurement mode. In linked or loop mode, the AWAKE bit is high whenever the device

experiences an activity condition, and it is low when the device experiences an inactivity condition.

The awake signal can be mapped to the INT1 pin or the INT2 pin allowing the pin to serve as a status output to connect or disconnect power to downstream circuitry based on the awake status of the accelerometer. Used in conjunction with loop mode, this configuration implements a simple, autonomous motion activated switch.

If the turn-on time of downstream circuitry can be tolerated, this motion switch configuration can save significant system level power by eliminating the standby current consumption of the remainder of the application circuit. This standby current can often exceed the full operating current of the ADXL371.

### MOTION WARNING

In addition to the activity threshold previously described, the ADXL371 offers a secondary threshold. This second threshold, the motion warning threshold, can be set independently of the activity threshold. It does not have any functionality related to autosleep, linked, or loop mode, or the device awake status. The purpose of the motion warning functionality is to issue a notification to the system, via the status bit and/or interrupt, that the observed acceleration has exceeded the second threshold. It is controlled by the THRESH\_ACT2\_x\_x registers, and by the ACTIVITY2 interrupt, which is sent only to the INT2 pin. Each axis has its own motion warning threshold. However, the motion warning activity interrupt does not have an activity timer. It is only used for single sample, activity detection. The motion warning threshold also shares the same referenced and absolute configuration as the primary activity detection.

## IMPACT DETECTION FEATURES

Impact detection applications often require high  $g$  and high bandwidth acceleration measurements, and the ADXL371 is designed with these applications in mind. Several features are included that target impact detection and aim to simplify the system design.

### WIDE BANDWIDTH

An impact is a transient event that produces an acceleration pulse with frequency content over a wide range. A sufficiently wide bandwidth is needed to capture the impact event because lowering bandwidth has the effect of reducing the magnitude of the recorded signal, resulting in measurement inaccuracy.

The ADXL371 can operate with bandwidths of up to 2560 Hz at extremely low power levels. A steep filter roll-off is also useful for effective suppression of out of band content, and the ADXL371 incorporates a four-pole, low-pass antialiasing filter for this purpose.

### INSTANT ON IMPACT DETECTION

The ADXL371 instant on mode is an ultra low power mode that continuously monitors the environment for impact events that exceed a built in threshold. When an impact is detected, the device switches into full measurement mode and captures the impact profile.

No digital data is available in this mode of operation. The user can configure the device to detect an impact between a threshold level of either 10  $g$  to 15  $g$  or 30  $g$  to 40  $g$  by using the INSTANT\_ON\_THRESH bit in the POWER\_CTL register. When an impact beyond the selected threshold is detected, the ADXL371 switches to full bandwidth measurement mode and begins outputting digital data.

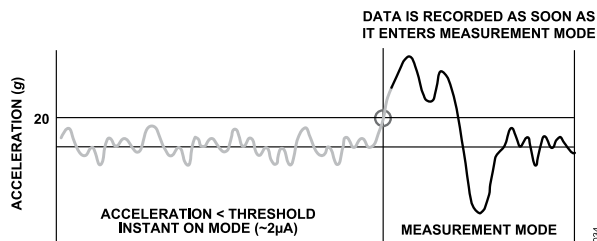

Figure 43. Instant On Mode Using Default Threshold

After the accelerometer is in full bandwidth measurement mode, the mode must be set back into instant on mode manually. The mode cannot return to instant on mode automatically.

### CAPTURING IMPACT EVENTS

In certain applications, a single (3-axis) acceleration sample at the peak of an impact event contains sufficient information about the event, and the full acceleration history is not required. For these applications, the ADXL371 provides the capability to store only the peak acceleration of each impact event. The ADXL371 peak detection function considers an impact event as an acceleration signal that occurs within an activity interrupt and the next inactivity interrupt. The peak of an impact event is defined as the  $x$ ,  $y$ , and  $z$  acceleration sample that has the highest magnitude of all

other values within an impact event, as shown in Figure 44. The magnitude of each sample set is calculated as  $x^2 + y^2 + z^2$ .

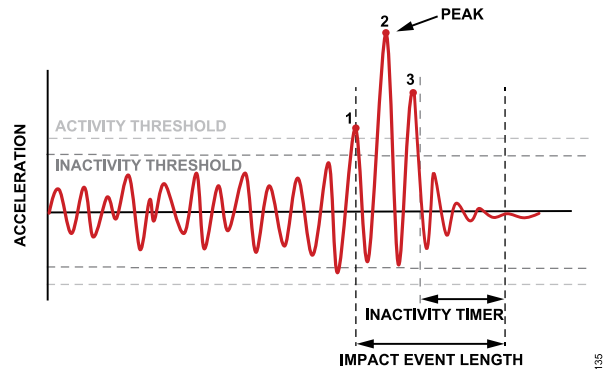

Figure 44. Capturing Impact Events

The peak detection feature stores the peak acceleration in the MAXPEAK\_x\_x registers (Register 0x15 to Register 0x1A). When these values are read out of the registers, the register data is cleared, and the device begins looking for a new peak. Furthermore, if MAXPEAK\_x\_x registers were not read after an impact event and another impact event with a higher peak occurs, the MAXPEAK\_x\_x registers are automatically updated with the higher peak acceleration values. On the contrary, if the next peak magnitude is lower than the current peak stored in MAXPEAK\_x\_x registers, the MAXPEAK\_x\_x registers are not updated. In the example of Figure 45, if the MAXPEAK\_x\_x registers are read after Impact Event 4, their values correspond to the peak detected during Impact Event 3, which was the highest peak of all four impact events.

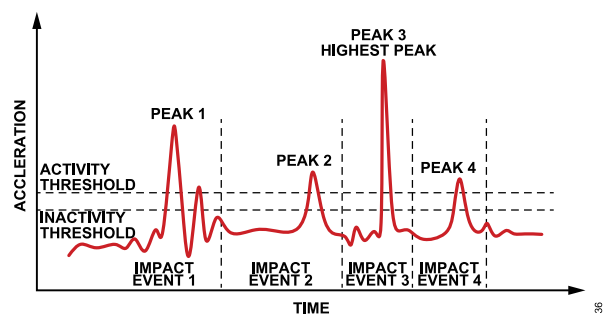

Figure 45. Capturing Highest Peak Within Multiple Impact Events

Follow these steps to enable peak detection:

1. Configure the FIFO\_CTL register into peak detect mode (b0011100X to Register 0x3A).
2. Set the desired activity threshold and time settings (Register 0x23 to Register 0x29).
3. Set the desired inactivity threshold and time settings (Register 0x2A to Register 0x31).
4. Set the activity mode to linked or loop mode (Register 0x3E).

The FIFO provides even more flexibility to the peak detection feature, allowing its use in applications that require to keep record

## IMPACT DETECTION FEATURES

of the peak of all impact events that occurred within a period of time, with minimal intervention from the host processor. To do so, follow these steps:

1. Configure the FIFO\_CTL register into peak detect mode and stream mode (b0011101X to Register 0x3A).
2. Set the desired activity threshold and time settings (Register 0x23 to Register 0x29).
3. Set the desired inactivity threshold and time settings (Register 0x2A to Register 0x31).
4. Set the activity mode to linked or loop mode (Register 0x3E).

Always read acceleration data from MAXPEAK\_x\_x registers and from the FIFO memory using multibyte transfer to ensure a concurrent and complete set of x, y, and z acceleration data is read.

### Limitations

The user must be aware that the ADXL371 cannot properly capture impact events of higher frequency than the user selected bandwidth. As a rule, the ADXL371 must be able to capture at least two samples from the moment the activity interrupt is triggered to the moment the peak acceleration occurs. If this requirement is not met, significantly lower acceleration values than the actual peak, or even zeros, may be stored in the MAXPEAK\_x\_x registers.

The peak detection function determines the peak of an event by comparing the sum square of each set of x, y, and z acceleration samples within an impact event. The sum square is performed internally using 7-bit multipliers, and because the acceleration data is 12-bit resolution, a maximum error of approximately  $\pm 3$  g can occur on the determination of the peak.

## FIFO

### BENEFITS OF THE FIFO

The FIFO buffer is an important feature in ultralow power applications in two ways: system level power savings and data recording/event context.

#### System Level Power Savings

Appropriate use of the FIFO enables system level power savings by enabling the host processor to sleep for extended periods while the accelerometer autonomously collects data. Alternatively, using the FIFO to collect data can unburden the host while it tends to other tasks.

#### Data Recording/Event Context

The FIFO can be used in a triggered mode to record all data leading up to an activity detection event, thereby providing context for the event. In the case of a system that identifies impact events, for example, the accelerometer can keep the entire system off while it stores acceleration data in its FIFO and looks for an activity event. When the impact event occurs, data collected prior to the event is frozen in the FIFO. The accelerometer can now wake the rest of the system and transfer this data to the host processor, thereby providing context for the impact event.

Generally, the more context available, the more intelligent decisions a system can achieve, making a deep FIFO especially useful. For example, the ADXL371 FIFO can store up to 512 1-axis samples at 400 Hz ODR to provide a 1.28 sec window, or 170 3-axis samples at 3200 Hz to provide a 50 ms window, which is a typical duration for impact events.

### USING THE FIFO

The FIFO is a 512-sample memory buffer that can save power, unburden the host processor, and autonomously record data.

FIFO operation is configured via Register 0x39 and Register 0x3A. The 512 FIFO samples can be allotted in several ways, such as the following:

- ▶ 170 sample sets of concurrent 3-axis data
- ▶ 256 sample sets of concurrent 2-axis data (user selectable)
- ▶ 512 sample sets of single-axis data
- ▶ 170 sets of impact event peak (x, y, z)

All FIFO modes must be configured while in standby mode. When reading data from multiple axes from the FIFO, to ensure that data is not overwritten and stored out of order, at least one sample set must be left in the FIFO after every read (therefore, a set of 3-axis data must have 169 samples at most).

The FIFO operates in one of the following four modes: FIFO disabled, oldest saved mode (first N), stream mode (last N), and triggered mode.

#### FIFO Disabled

When the FIFO is disabled, no new data is stored in it, and any data already in it is cleared.

The FIFO is disabled by setting the FIFO\_MODE bits in the FIFO\_CTL register (Register 0x3A) to 0b00.

#### Oldest Saved Mode (First N)

In oldest saved mode, the FIFO accumulates data until it is full and then stops. After reading the data, the FIFO must be disabled and re-enabled to save a new set of data. One possible use case for this mode is to enable it right after entering instant on mode. After a shock is detected, the data immediately stores in the FIFO to be read whenever convenient.

The FIFO is placed into oldest saved mode by setting the FIFO\_MODE bits in the FIFO\_CTL register (Register 0x3A) to 0b11.

#### Stream Mode (Last N)

In stream mode, the FIFO always contains the most recent data. The oldest sample is discarded when space is needed to make room for a newer sample.

Stream mode is useful for unburdening a host processor. The processor can tend to other tasks while data is being collected in the FIFO. When the FIFO fills to a certain number of samples (specified by the FIFO\_SAMPLES register along with Bit 0 in the FIFO\_CTL register), it triggers a watermark interrupt (if this interrupt is enabled). At this point, the host processor can read the contents of the entire FIFO and then return to its other tasks as the FIFO fills again.

The FIFO is placed into stream mode by setting the FIFO\_MODE bits in the FIFO\_CTL register (Register 0x3A) to 0b01.

#### Triggered Mode

In triggered mode, the FIFO operates as in stream mode until an activity detection event, after which it saves the samples surrounding that event. The operation is similar to a one-time run trigger on an oscilloscope. The number of samples to be saved after the activity event is specified in FIFO\_SAMPLES (Register 0x39[7:0], along with Bit 0 in the FIFO\_CTL register, Register 0x3A). For example if the FIFO\_SAMPLE is set to 12, there are 500 samples before the trigger and 12 after the trigger. The trigger can be reset by clearing the activity interrupt and reading all 512 locations of the FIFO. If this is not complete, future FIFO data reads may contain invalid data. Place the FIFO into triggered mode by setting the FIFO\_MODE bits in the FIFO\_CTL register (Register 0x3A) to 0b10.

#### RETRIEVING DATA FROM FIFO

Access FIFO data by reading the FIFO\_DATA register. A multibyte read to this register does not auto-increment the address, and

## FIFO

instead continues to pop data from the FIFO. Data is left justified and formatted as shown in [Table 12](#).

When reading data, the most significant byte (Bits[B15:B8]) is read first, followed by the least significant byte (Bits[B7:B0]).

Bits[B15:B4] represent the 12-bit, two's complement acceleration data. Bit 0 serves as a series start indicator: only the first data byte of a series contains a 1 in this bit, and the remaining items contain a 0.

**Table 12. FIFO Buffer Data Format—Bits[B15:B8]**

B15 (MSB)	B14	B13	B12	B11	B10	B9	B8
Data							

**Table 13. FIFO Buffer Data Format—Bits[B7:B0]**

B7	B6	B5	B4	B3	B2	B1	B0
Data				Reserved		Series start indicator	

## INTERRUPTS

Several of the built in functions of the ADXL371 can trigger interrupts to alert the host processor of certain status conditions. The functionality of these interrupts is described in this section.

### INTERRUPT PINS

Interrupts can be mapped to either (or both) of two designated output pins, INT1 and INT2, by setting the appropriate bits in the INT1\_MAP register and INT2\_MAP register, respectively. All functions can be used simultaneously. If multiple interrupts are mapped to one pin, the OR combination of the interrupts determines the status of the pin.

If no functions are mapped to an interrupt pin, that pin is automatically configured to a high impedance (high-Z) state. The INTx pins are also placed in the high-Z state upon a reset.

When a certain status condition is detected, the INTx pin that condition is mapped to activates. The configuration of the INTx pin is active high by default so when the pin is activated, it goes high. However, this configuration can be switched to active low by setting the INTx\_LOW bit in the appropriate INTx\_MAP register.

The INTx pins can connect to the interrupt input of a host processor where interrupts are responded to with an interrupt routine. Because multiple functions can be mapped to the same pin, the STATUS register can determine which condition caused the interrupt to trigger.

Interrupts are cleared in several of the following ways:

- ▶ Reading the STATUS2 register clears ACTIVITY and INACT interrupts. However, if activity detection is operating in default mode, and the activity or inactivity timers are set to 0, the only way to clear the activity or inactivity bits, respectively, is to set the device into standby mode and restart full bandwidth measurement mode.
- ▶ Reading the STATUS2 register clears the ACTIVITY2 interrupt. It is not required to set the device back in standby mode to clear this interrupt, no matter what value is set for the activity timer.
- ▶ Reading from the data registers clears the DATA\_RDY interrupt.
- ▶ Reading enough data from the FIFO buffer so that interrupt conditions are no longer met, and then reading the STATUS register (Register 0x04) clears the FIFO\_RDY, FIFO\_FULL, and FIFO\_OVR interrupts.

Both INTx pins are push-pull low impedance pins with an output impedance of about 500  $\Omega$  (typical) and digital output specifications as shown in [Table 14](#). Both INTx pins have bus keepers that hold the pins to a valid logic state when the pins are in high impedance mode.

To prevent interrupts from being falsely triggered during configuration, disable interrupts while their settings, such as thresholds, timings, or other values, are configured.

### Alternate Functions

The INT1 and INT2 pins can be configured for use as input pins instead of for signaling interrupts. INT1 is used as an external clock input when the EXT\_CLK bit in the TIMING register is set. INT2 is used as the trigger input for synchronized sampling when the EXT\_SYNC bit in the TIMING register is set. One or both of these alternate functions can be used concurrently. However, if an interrupt pin is used for its alternate function, the INTx pin cannot be used simultaneously to signal interrupts.

## TYPES OF INTERRUPTS

### Activity and Inactivity Interrupts

The ACTIVITY bit and INACT bit are set when activity and inactivity are detected, respectively. Detection procedures and criteria are described in the [Autonomous Event Detection](#) section.

### Data Ready Interrupt

The DATA\_RDY bit is set when new valid data is available, and it is cleared when no new data is available.

The DATA\_RDY bit does not set while any of the data registers are being read. If DATA\_RDY = 0 prior to a register read and new data becomes available during the register read, DATA\_RDY remains 0 until the read completes and then only sets to 1.

If DATA\_RDY = 1 prior to a register read, it is cleared at the start of the register read.

If DATA\_RDY = 1 prior to a register read and new data becomes available during the register read, DATA\_RDY is cleared to 0 at the start of the register read and remains 0 throughout the read. When the read completes, DATA\_RDY is set to 1.

## FIFO Interrupts

### FIFO Watermark

The FIFO\_FULL bit is set when the number of samples stored in the FIFO is equal to or exceeds the number specified in FIFO\_SAMPLES (Register 0x39 together with Bit 0 in the FIFO\_CTL register). The FIFO\_FULL bit is cleared automatically when enough samples are read from the FIFO, such that the number of samples remaining is lower than that specified.

If the number of FIFO samples is set to 0, the watermark interrupt is set. To avoid unexpectedly triggering this interrupt, the default value of the FIFO\_SAMPLES register is 0x80.

### FIFO Ready

The FIFO\_RDY bit is set when there is at least one valid sample available in the FIFO output buffer. This bit is cleared when no valid data is available in the FIFO. In FIFO triggered mode, it is only set



## INTERRUPTS

after the activity interrupt is detected, and the data surrounding the event is saved in the FIFO.

### Overrun

The FIFO\_OVR bit is set when the FIFO has overrun or overflowed, such that new data replaces unread data, which may indicate a full FIFO that has not yet been emptied or a clocking error caused by

a slow SPI transaction. If the FIFO is configured to oldest saved mode, an overrun event indicates that there is insufficient space available for a new sample.

The FIFO\_OVR bit is cleared when both the contents of the FIFO and the STATUS register are read. It is also cleared when the FIFO is disabled.

**Table 14. Interrupt Pin Digital Output**

Parameter	Test Conditions	Limit <sup>1</sup>		Unit
		Min	Max	
Digital Output				
Low Level Output Voltage ( $V_{OL}$ )	$I_{OL} = 500 \mu\text{A}$		$0.2 \times V_{DDI/O}$	V
High Level Output Voltage ( $V_{OH}$ )	$I_{OH} = -300 \mu\text{A}$	$0.8 \times V_{DDI/O}$		V
Low Level Output Current ( $I_{OL}$ )	$V_{OL} = V_{OL, MAX}$	500		$\mu\text{A}$
High Level Output Current ( $I_{OH}$ )	$V_{OH} = V_{OH, MIN}$		-300	$\mu\text{A}$
Pin Capacitance	$f_{IN} = 1 \text{ MHz}, V_{IN} = 2.0 \text{ V}$		8	pF
Rise/Fall Time				
Rise Time ( $t_R$ ) <sup>2</sup>	$C_{LOAD} = 150 \text{ pF}$		210	ns
Fall Time ( $t_F$ ) <sup>3</sup>	$C_{LOAD} = 150 \text{ pF}$		150	ns

<sup>1</sup> Limits based on characterization results, not production tested.

<sup>2</sup> Rise time is measured as the transition time from  $V_{OL, MAX}$  to  $V_{OH, MIN}$  of the interrupt pin.

<sup>3</sup> Fall time is measured as the transition time from  $V_{OH, MIN}$  to  $V_{OL, MAX}$  of the interrupt pin.

## ADDITIONAL FEATURES

### USING AN EXTERNAL CLOCK

When operating at 2560 Hz ODR or lower, the ADXL371 has a built in 307.2 kHz (typical) clock that, by default, serves as the time base for internal operations. At 5120 Hz ODR, this clock speed increases to 614.4 kHz (typical). If desired, an external clock can be provided instead, for either improved clock frequency accuracy or for control of the output data rate. To use an external clock, set the EXT\_CLK bit (Bit 1) in the TIMING register (Register 0x3D) and apply a clock to the INT1 pin.

The external clock can operate at the nominal 307.2 kHz or slower (when using  $ODR \leq 2560$  Hz), or 614.4 kHz or slower (when using  $ODR = 5120$  Hz) to allow the user to achieve any desired output data rate. Lower external clock rates must be used with caution because it may result in aliasing of high frequency signals that may be present in certain applications.

ODR and bandwidth scale proportionally with the clock. The ADXL371 provides a discrete number of options for ODR. ODRs other than those provided are achieved by selecting an appropriate clock frequency. For example, to achieve a 2048 Hz ODR, use the 2560 Hz setting with a clock frequency that is 80% of nominal, or 245.76 kHz. Bandwidth also scales by the same ratio, therefore, if a 320 Hz bandwidth is selected, the resulting bandwidth is 256 Hz.

### SYNCHRONIZED DATA SAMPLING

For applications that require a precisely timed acceleration measurement, the ADXL371 features an option to synchronize acceleration sampling to an external trigger. The EXT\_SYNC bit in the TIMING register enables this feature. When the EXT\_SYNC bit is set to 1, the INT2 pin automatically reconfigures for use as the sync trigger input.

When external triggering is enabled, it is up to the system designer to ensure that the sampling frequency meets system requirements. Sampling too infrequently causes aliasing. Noise can be lowered by oversampling. However, sampling at too high a frequency may not allow enough time for the accelerometer to process the acceleration data and convert it to valid digital output data.

When the Nyquist criterion is met, signal integrity is maintained. An internal antialiasing filter is available in the ADXL371 and can assist the system designer in maintaining signal integrity. To prevent aliasing, set the filter bandwidth to a frequency no greater than half the sampling rate. For example, when sampling at 1280 Hz, set the filter bandwidth to no higher than 640 Hz.

Because of internal timing requirements, the maximum allowable external trigger frequencies are as follows:

- ▶ 1-axis data = 3100 Hz
- ▶ 2-axis data = 2700 Hz
- ▶ 3-axis data = 2200 Hz

These values are doubled when an ODR rate of 5120 Hz is selected. Additionally, the trigger signal applied to the INT2 pin must meet the following criteria:

- ▶ The trigger signal must be active high.
- ▶ The pulse width of the trigger signal must be at least 53  $\mu$ s.
- ▶ The minimum sampling frequency is set only by system requirements. Samples need not be polled at any minimum rate. However, if samples are polled at a rate lower than the bandwidth set by the antialiasing filter, aliasing may occur.

The EXT\_SYNC is an active high signal. Due to the asynchronous nature of the internal clock and external sync, there may be a one ODR clock cycle difference between consecutive external sync pulses. The external sync sets the ODR of the system. For example, if sending an external sync at a 2 kHz rate, all three axes (if enabled) are sampled in that 2 kHz window.

### SELF TEST

When the self test function is invoked, an electrostatic force is applied to the mechanical sensor. This electrostatic force moves the mechanical sensing element in the same manner as acceleration, and the acceleration experienced by the device increases because of this force. The high-pass filter is automatically disabled for this feature.

#### Self Test Procedure

The self test function is enabled via the ST bit in the SELF\_TEST register, Register 0x40. The ST\_DONE bit indicates when the test is completed. Figure 46 describes the self test profile from when ST is set until ST\_DONE goes high, which typically takes around 200 ms. The self test passes if  $|\Delta ST|$  is greater than 5 LSB.

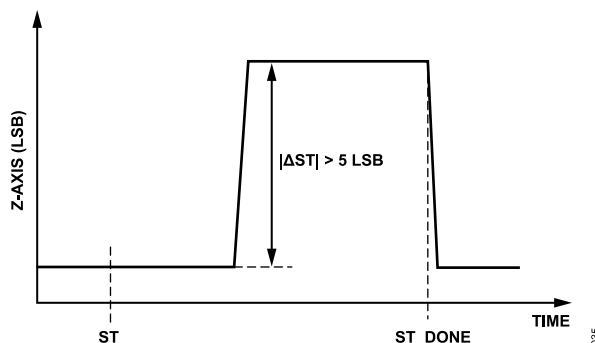

Figure 46. Self Test Waveform

The recommended procedure for using the self test functionality is as follows:

1. Ensure that the low-pass activity filter is enabled.
2. Place the device in measurement mode.
3. Wait until the filter settling time passes.
4. Start the self test by setting the ST bit in the SELF\_TEST register (Register 0x40).

## ADDITIONAL FEATURES

5. Read the acceleration data from the z-axis (Register 0x0C and Register 0x0D) and store the data until the self test completes (ST\_DONE goes high).
6. Average the first 50 ms of data right after ST is set.
7. Average the last 50 ms of data right before ST\_DONE goes high.
8. If the absolute value of the difference between the two averaged values is greater than 5 LSB, the self test passes.

During the deviation of the z-axis, the x-axis and y-axis also show deviation, which is normal. However, the outputs of the x-axis and y-axis cannot be used to qualify pass or fail of the self test.

## USER REGISTER PROTECTION

The ADXL371 includes user register protection for single event upsets (SEUs). An SEU is a change of state caused by ions or electromagnetic radiation striking a sensitive node in a microelectronic device. The state change is a result of the free charge created by ionization in or close to an important node of a logic element (for example, a memory bit). The SEU itself is not considered permanently damaging to transistor or circuit functionality, but it can create erroneous register values. The registers protected from SEU are Register 0x20 to Register 0x3F.

Protection is implemented via a 99-bit error correcting (Hamming type) code and detects both single bit and double bit errors. The check bits are recomputed any time a write to any of the protected registers occurs. At any time, if the stored version of the check bits is not in agreement with the current check bit calculation, the ERR\_USER\_REGS status bit is set.

The ERR\_USER\_REGS bit in the STATUS register starts high when set on an unconfigured device and clears after the first register write.

## USER OFFSET TRIMS

The ADXL371 has a 4-bit offset trim for each axis that allows users to add positive or negative offset to the default static acceleration values and correct any deviations from ideal that may result as a consequence of varying the operating parameters of the device. The offset trims have a full-scale range of approximately  $\pm 60$  LSB with a trim profile, as shown in [Figure 47](#).

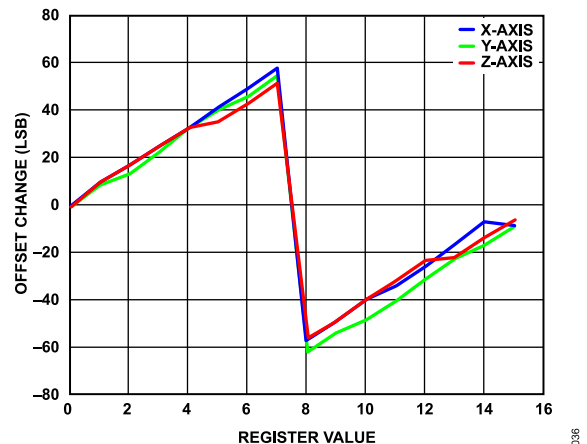

Figure 47. User Offset Trim Profile

## SERIAL COMMUNICATIONS

### SERIAL INTERFACE

The ADXL371 is designed to communicate in either the SPI or the I<sup>2</sup>C protocol. It autodetects the format being used, requiring no configuration control to select the format.

#### SPI Protocol

The timing scheme is as follows: phase (CPHA) = polarity (CPOL) = 0. The ADXL371 supports a SCLK frequency up to 10 MHz. Wire the ADXL371 for SPI communication as shown in Figure 48. For successful communication, follow the logic thresholds and timing parameters in Table 1. The command structure for the read register and write register are shown in Figure 2 and Figure 3, respectively. The read and write register commands support multibyte (burst) read/write access. The waveform diagrams for multibyte read and write commands are shown in Figure 4 and Figure 5, respectively.

Ignore data transmitted from the ADXL371 to the master device during writes to the ADXL371.

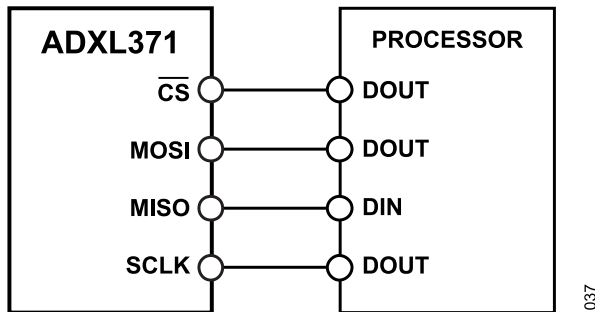

Figure 48. 4-Wire SPI Connection Diagram

#### I<sup>2</sup>C Protocol

The ADXL371 supports standard (100 kHz), fast (up to 1 MHz), and high speed (up to 3.4 MHz) data transfer modes if the bus parameters given in Table 1 and shown in Figure 1 are met. There is no minimum SCL frequency, with the exception that when reading data, the clock must be fast enough to read an entire sample set before new data overwrites it. Single-byte or multibyte reads and writes are supported. With the MISO pin low, the I<sup>2</sup>C address for the device is 0x1D, and an alternate I<sup>2</sup>C address of 0x53 can be chosen by pulling the MISO pin high.

There are no internal pull-up or pull-down resistors for any unused pins. Therefore, there is no known state or default state for the MISO and SCLK pins if left floating or unconnected. It is a requirement that SCLK be connected to ground when communicating to the ADXL371 using the I<sup>2</sup>C.

Due to communication speed limitations, the maximum output data rate when using about 6 kHz I<sup>2</sup>C is 640 Hz and scales linearly with I<sup>2</sup>C communication speed. Operation at an output data rate higher than the recommended maximum can result in an undesirable effect on the acceleration data, including missing samples or additional noise.

If other devices are connected to the same I<sup>2</sup>C bus, the nominal operating voltage level of these other devices cannot exceed  $V_{DD/I/O}$  by more than 0.3 V. External pull-up resistors ( $R_P$ ) are necessary for proper I<sup>2</sup>C operation. Single-byte or multibyte reads and writes are supported, as shown from Figure 2 to Figure 4.

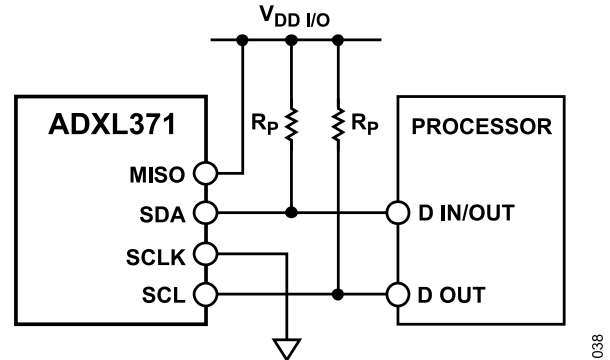

Figure 49. I<sup>2</sup>C Connection Diagram (ADXL371 Device ID = 0x53)

#### MULTIBYTE TRANSFERS

Both the SPI and I<sup>2</sup>C protocols support multibyte transfers, also known as burst transfers. A register read or write begins with the address specified in the command and autoincrements for each additional byte in the transfer. Always read acceleration data using multibyte transfers to ensure that a concurrent and complete set of x-, y-, and z-acceleration data is read.

The FIFO runs on the serial port clock during FIFO reads and can sustain bursting at the SPI clock rate as long as the SPI clock is 1 MHz or faster.

The address auto-increment function is disabled when the FIFO address is used, which is so that data can be read continuously from the FIFO as a multibyte transaction. In cases where the starting address of a multibyte transaction is less than the FIFO address, the address auto-increments until the FIFO address is reached, and then it stops at the FIFO address.

When writing data to the ADXL371 in I<sup>2</sup>C mode, the no acknowledge (NACK) bit never generates. Instead, the acknowledge (ACK) bit is sent after every received byte because it is not known how many bytes are included in the transfer. The master decides how many bytes are sent and ends the transaction with the stop condition.

#### INVALID ADDRESSES AND ADDRESS FOLDING

The ADXL371 has a 6-bit address bus, mapping only 104 registers in the possible 256 register address space. The addresses do not fold to repeat the registers at addresses above 0x104. Attempted access to register addresses above 0x104 are mapped to the invalid register at 0x67 and have no functional effect.

**SERIAL COMMUNICATIONS**

Register 0x00 to Register 0x41 are for customer access, as described in [Table 15](#). Register 0x42 to Register 0x67 are reserved for factory use.

## REGISTER MAP

Table 15. Register Map

Reg	Name	Bits	Bit 7	Bit 6	Bit 5	Bit 4	Bit 3	Bit 2	Bit 1	Bit 0	Reset	RW	
0x00	DEVID_AD	[7:0]	DEVID_AD								0xAD	R	
0x01	DEVID_MST	[7:0]	DEVID_MST								0x1D	R	
0x02	PARTID	[7:0]	DEVID_PRODUCT								0xFA	R	
0x03	REVID	[7:0]	REVID								0xFB	R	
0x04	STATUS	[7:0]	ERR_	AWAKE	USER_NVM_	RESERVED	FIFO_OVR	FIFO_FULL	FIFO_	DATA_RDY	0xA0	R	
			USER_		BUSY				RDY				
			REGS										
0x05	STATUS2	[7:0]	RESERVED	ACTIVITY2	ACTIVITY	INACT	RESERVED				0x00	R	
0x06	FIFO_ENTRIES2	[7:0]	RESERVED						FIFO_ENTRIES[9:8]		0x00	R	
0x07	FIFO_ENTRIES	[7:0]	FIFO_ENTRIES[7:0]								0x00	R	
0x08	XDATA_H	[7:0]	XDATA[11:4]								0x00	R	
0x09	XDATA_L	[7:0]	XDATA[3:0]				RESERVED				0x00	R	
0x0A	YDATA_H	[7:0]	YDATA[11:4]								0x00	R	
0x0B	YDATA_L	[7:0]	YDATA[3:0]				RESERVED				0x00	R	
0x0C	ZDATA_H	[7:0]	ZDATA[11:4]								0x00	R	
0x0D	ZDATA_L	[7:0]	ZDATA[3:0]				RESERVED				0x00	R	
0x15	MAXPEAK_X_H	[7:0]	MAXPEAK_X[11:4]								0x00	R	
0x16	MAXPEAK_X_L	[7:0]	MAXPEAK_X[3:0]				RESERVED				0x00	R	
0x17	MAXPEAK_Y_H	[7:0]	MAXPEAK_Y[11:4]								0x00	R	
0x18	MAXPEAK_Y_L	[7:0]	MAXPEAK_Y[3:0]				RESERVED				0x00	R	
0x19	MAXPEAK_Z_H	[7:0]	MAXPEAK_Z[11:4]								0x00	R	
0x1A	MAXPEAK_Z_L	[7:0]	MAXPEAK_Z[3:0]				RESERVED				0x00	R	
0x20	OFFSET_X	[7:0]	RESERVED				OFFSET_X				0x00	R/W	
0x21	OFFSET_Y	[7:0]	RESERVED				OFFSET_Y				0x00	R/W	
0x22	OFFSET_Z	[7:0]	RESERVED				OFFSET_Z				0x00	R/W	
0x23	THRESH_ACT_X_H	[7:0]	THRESH_ACT_X[10:3]								0x00	R/W	
0x24	THRESH_ACT_X_L	[7:0]	THRESH_ACT_X[2:0]				RESERVED			ACT_REF	ACT_X_EN	0x00	R/W
0x25	THRESH_ACT_Y_H	[7:0]	THRESH_ACT_Y[10:3]								0x00	R/W	
0x26	THRESH_ACT_Y_L	[7:0]	THRESH_ACT_Y[2:0]				RESERVED			ACT_Y_EN	0x00	R/W	
0x27	THRESH_ACT_Z_H	[7:0]	THRESH_ACT_Z[10:3]								0x00	R/W	
0x28	THRESH_ACT_Z_L	[7:0]	THRESH_ACT_Z[2:0]				RESERVED			ACT_Z_EN	0x00	R/W	
0x29	TIME_ACT	[7:0]	ACT_COUNT								0x00	R/W	
0x2A	THRESH_INACT_X_H	[7:0]	THRESH_INACT_X[10:3]								0x00	R/W	
0x2B	THRESH_INACT_X_L	[7:0]	THRESH_INACT_X[2:0]				RESERVED			INACT_REF	INACT_X_EN	0x00	R/W
0x2C	THRESH_INACT_Y_H	[7:0]	THRESH_INACT_Y[10:3]								0x00	R/W	
0x2D	THRESH_INACT_Y_L	[7:0]	THRESH_INACT_Y[2:0]				RESERVED			INACT_Y_EN	0x00	R/W	
0x2E	THRESH_INACT_Z_H	[7:0]	THRESH_INACT_Z[10:3]								0x00	R/W	
0x2F	THRESH_INACT_Z_L	[7:0]	THRESH_INACT_Z[2:0]				RESERVED			INACT_Z_EN	0x00	R/W	
0x30	TIME_INACT_H	[7:0]	INACT_COUNT[15:8]								0x00	R/W	
0x31	TIME_INACT_L	[7:0]	INACT_COUNT[7:0]								0x00	R/W	
0x32	THRESH_ACT2_X_H	[7:0]	THRESH_ACT2_X[10:3]								0x00	R/W	

## REGISTER MAP

Table 15. Register Map

Reg	Name	Bits	Bit 7	Bit 6	Bit 5	Bit 4	Bit 3	Bit 2	Bit 1	Bit 0	Reset	RW	
0x33	THRESH_ACT2_X_L	[7:0]	THRESH_ACT2_X[2:0]			RESERVED			ACT2_REF	ACT2_X_EN	0x00	R/W	
0x34	THRESH_ACT2_Y_H	[7:0]	THRESH_ACT2_Y[10:3]									0x00	R/W
0x35	THRESH_ACT2_Y_L	[7:0]	THRESH_ACT2_Y[2:0]			RESERVED			ACT2_Y_EN	0x00	R/W		
0x36	THRESH_ACT2_Z_H	[7:0]	THRESH_ACT2_Z[10:3]									0x00	R/W
0x37	THRESH_ACT2_Z_L	[7:0]	THRESH_ACT2_Z[2:0]			RESERVED			ACT2_Z_EN	0x00	R/W		
0x38	HPF	[7:0]	RESERVED						HPF_CORNER		0x00	R/W	
0x39	FIFO_SAMPLES	[7:0]	FIFO_SAMPLES[7:0]									0x80	R/W
0x3A	FIFO_CTL	[7:0]	RESERVED		FIFO_FORMAT			FIFO_MODE		FIFO_SAMPLES[8]	0x00	R/W	
0x3B	INT1_MAP	[7:0]	INT1_LOW	AWAKE_INT1	ACT_INT1	INACT_INT1	FIFO_OVR_INT1	FIFO_FULL_INT1	FIFO_RDY_INT1	DATA_RDY_INT1	0x00	R/W	
0x3C	INT2_MAP	[7:0]	INT2_LOW	AWAKE_INT2	ACT2_INT2	INACT_INT2	FIFO_OVR_INT2	FIFO_FULL_INT2	FIFO_RDY_INT2	DATA_RDY_INT2	0x00	R/W	
0x3D	TIMING	[7:0]	ODR			WAKEUP_RATE			EXT_CLK	EXT_SYNC	0x00	R/W	
0x3E	MEASURE	[7:0]	USER_OR_DISABLE	AUTO-SLEEP	LINKLOOP		LOW_NOISE	BANDWIDTH			0x00	R/W	
0x3F	POWER_CTL	[7:0]	I2C_HSM_EN	RESERVED	INSTANT_ON_THRESH	FILTER_SETTLE	LPF_DISABLE	HPF_DISABLE	MODE		0x00	R/W	
0x40	SELF_TEST	[7:0]	RESERVED						ST_DONE	ST	0x00	R/W	
0x41	RESET	[7:0]	RESET									0x00	W
0x42	FIFO_DATA	[7:0]	FIFO_DATA									0x00	R

## REGISTER DETAILS

## ANALOG DEVICES ID REGISTER

Address: 0x00, Reset: 0xAD, Name: DEVID\_AD

This register contains the Analog Devices, Inc., ID, 0xAD.

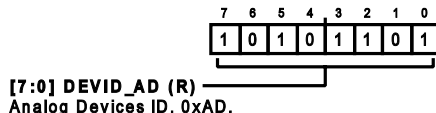

Table 16. Bit Descriptions for DEVID\_AD

Bits	Bit Name	Settings	Description	Reset	Access
[7:0]	DEVID_AD		Analog Devices ID, 0xAD.	0xAD	R

## ANALOG DEVICES MEMS ID REGISTER

Address: 0x01, Reset: 0x1D, Name: DEVID\_MST

This register contains the Analog Devices MEMS ID, 0x1D.

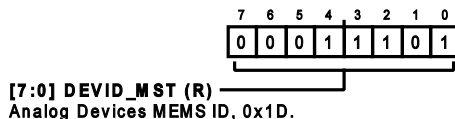

Table 17. Bit Descriptions for DEVID\_MST

Bits	Bit Name	Settings	Description	Reset	Access
[7:0]	DEVID_MST		Analog Devices MEMS ID, 0x1D.	0x1D	R

## DEVICE ID REGISTER

Address: 0x02, Reset: 0xFA, Name: PARTID

This register contains the device ID, 0xFA (372 octal).

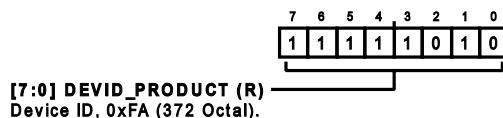

Table 18. Bit Descriptions for PARTID

Bits	Bit Name	Settings	Description	Reset	Access
[7:0]	DEVID_PRODUCT		Device ID, 0xFA (372 Octal).	0xFA	R

## PRODUCT REVISION ID REGISTER

Address: 0x03, Reset: 0xFB, Name: REVID

This register contains the mask revision ID, beginning with 0x00 and incrementing for each subsequent revision.

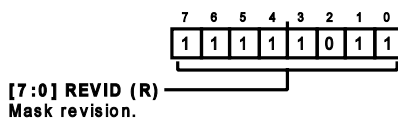



## REGISTER DETAILS

Table 19. Bit Descriptions for REVID

Bits	Bit Name	Settings	Description	Reset	Access
[7:0]	REVID		Mask revision.	0xFB	R

## STATUS REGISTER

Address: 0x04, Reset: 0xA0, Name: STATUS

This register includes the following bits that describe various conditions of the ADXL371.

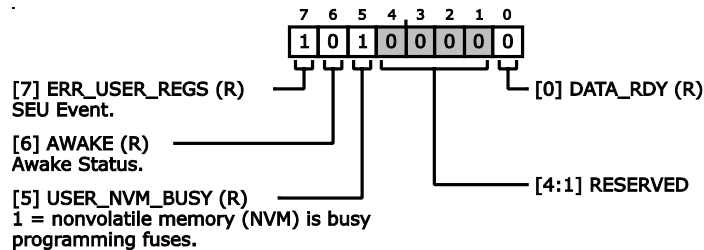

Table 20. Bit Descriptions for STATUS

Bits	Bit Name	Settings	Description	Reset	Access
7	ERR_USER_REGS		SEU Event. An SEU event is detected in a user register.	0x1	R
6	AWAKE		Awake Status. Activity detected, and the device is moving.	0x0	R
5	USER_NVM_BUSY		1 = nonvolatile memory (NVM) is busy programming fuses.	0x1	R
[4:1]	RESERVED		Reserved.	0x0	R
0	DATA_RDY		Status is high after the full data set completes. A complete x, y, and z measurement was made, and results can be read.	0x0	R

## ACTIVITY STATUS REGISTER

Address: 0x05, Reset: 0x00, Name: STATUS2

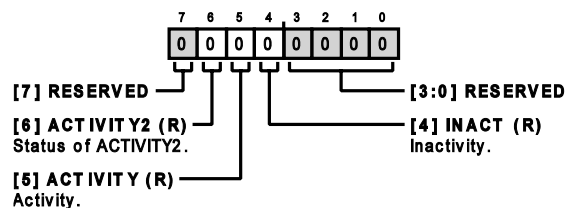

Table 21. Bit Descriptions for STATUS2

Bits	Bit Name	Settings	Description	Reset	Access
7	RESERVED		Reserved.	0x0	R
6	ACTIVITY2		Status of ACTIVITY2.	0x0	R
5	ACTIVITY		Activity. Activity is detected.	0x0	R
4	INACT		Inactivity. Inactivity is detected.	0x0	R
[3:0]	RESERVED		Reserved.	0x0	R

## X-AXIS DATA REGISTER, MSB

Address: 0x08, Reset: 0x00, Name: XDATA\_H

These two registers contain the x-axis acceleration data. Data is left justified and formatted as two's complement. XDATA\_H contains the eight MSBs, and XDATA\_L contains the four LSBs of the 12-bit value.

## REGISTER DETAILS

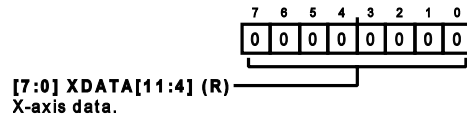

Table 22. Bit Descriptions for XDATA\_H

Bits	Bit Name	Settings	Description	Reset	Access
[7:0]	XDATA[11:4]		X-axis data.	0x0	R

## X-AXIS DATA REGISTER, LSB

Address: 0x09, Reset: 0x00, Name: XDATA\_L

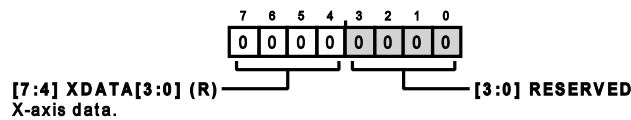

Table 23. Bit Descriptions for XDATA\_L

Bits	Bit Name	Settings	Description	Reset	Access
[7:4]	XDATA[3:0]		X-axis data.	0x0	R
[3:0]	RESERVED		Reserved.	0x0	R

## Y-AXIS DATA REGISTER, MSB

Address: 0x0A, Reset: 0x00, Name: YDATA\_H

The YDATA\_H and YDATA\_L registers contain the y-axis, LSB acceleration data. Data is left justified and formatted as twos complement. YDATA\_H contains the eight MSBs, and YDATA\_L contains the four LSBs of the 12-bit value.

YDATA\_L latches on a read of YDATA\_H to ensure data integrity.

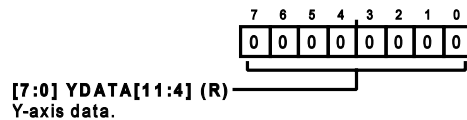

Table 24. Bit Descriptions for YDATA\_H

Bits	Bit Name	Settings	Description	Reset	Access
[7:0]	YDATA[11:4]		Y-axis data.	0x0	R

## Y-AXIS DATA REGISTER, LSB

Address: 0x0B, Reset: 0x00, Name: YDATA\_L

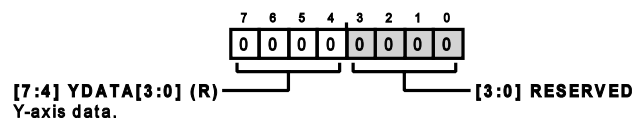

Table 25. Bit Descriptions for YDATA\_L

Bits	Bit Name	Settings	Description	Reset	Access
[7:4]	YDATA[3:0]		Y-axis data.	0x0	R
[3:0]	RESERVED		Reserved.	0x0	R

## REGISTER DETAILS

## Z-AXIS DATA REGISTER, MSB

Address: 0x0C, Reset: 0x00, Name: ZDATA\_H

These two registers contain the z-axis acceleration data. Data is left justified and formatted as twos complement. ZDATA\_H contains the eight MSBs, and ZDATA\_L contains the four LSBs of the 12-bit value.

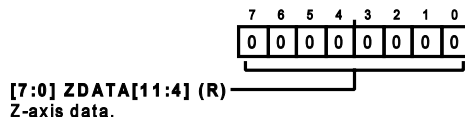

Table 26. Bit Descriptions for ZDATA\_H

Bits	Bit Name	Settings	Description	Reset	Access
[7:0]	ZDATA[11:4]		Z-axis data.	0x0	R

## Z-AXIS DATA REGISTER, LSB

Address: 0x0D, Reset: 0x00, Name: ZDATA\_L

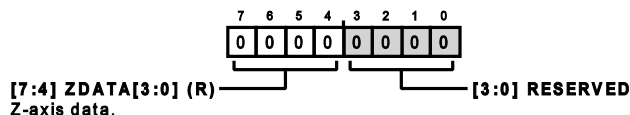

Table 27. Bit Descriptions for ZDATA\_L

Bits	Bit Name	Settings	Description	Reset	Access
[7:4]	ZDATA[3:0]		Z-axis data.	0x0	R
[3:0]	RESERVED		Reserved.	0x0	R

## OFFSET TRIM REGISTERS

Offset trim registers are each four bits and offer user set, offset adjustments in twos complement format. The scale factor of these registers is shown in [Figure 47](#).

## X-AXIS OFFSET TRIM REGISTER, LSB

Address: 0x20, Reset: 0x00, Name: OFFSET\_X

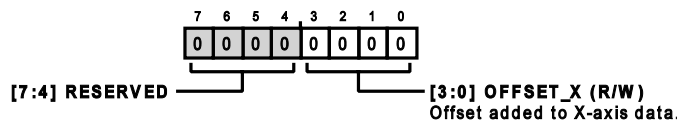
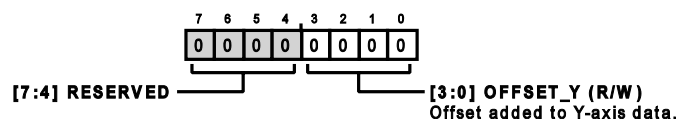

Table 28. Bit Descriptions for OFFSET\_X

Bits	Bit Name	Settings	Description	Reset	Access
[7:4]	RESERVED		Reserved.	0x0	R
[3:0]	OFFSET_X		Offset added to X-axis data.	0x0	R/W

## Y-AXIS OFFSET TRIM REGISTER, LSB

Address: 0x21, Reset: 0x00, Name: OFFSET\_Y



## REGISTER DETAILS

Table 29. Bit Descriptions for OFFSET\_Y

Bits	Bit Name	Settings	Description	Reset	Access
[7:4]	RESERVED		Reserved.	0x0	R
[3:0]	OFFSET_Y		Offset added to Y-axis data.	0x0	R/W

## Z-AXIS OFFSET TRIM REGISTER, LSB

Address: 0x22, Reset: 0x00, Name: OFFSET\_Z

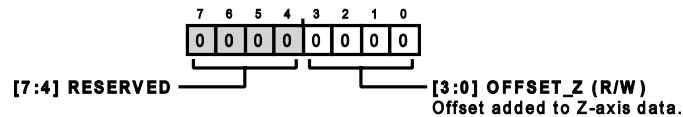

Table 30. Bit Descriptions for OFFSET\_Z

Bits	Bit Name	Settings	Description	Reset	Access
[7:4]	RESERVED		Reserved.	0x0	R
[3:0]	OFFSET_Z		Offset added to Z-axis data.	0x0	R/W

## X-AXIS ACTIVITY THRESHOLD REGISTER, MSB

Address: 0x23, Reset: 0x00, Name: THRESH\_ACT\_X\_H

This 11-bit unsigned value sets the threshold for activity detection. This value is set in codes and the scale factor is 100 mg per code. To detect activity, the absolute value of the 12-bit acceleration data is compared with the 11-bit (unsigned) activity threshold value. The THRESH\_ACT\_X\_L register contains the least significant bits, and the THRESH\_ACT\_X\_H register contains the most significant byte of the activity threshold value.



Table 31. Bit Descriptions for THRESH\_ACT\_X\_H

Bits	Bit Name	Settings	Description	Reset	Access
[7:0]	THRESH_ACT_X[10:3]		Threshold for activity detection. The 8 MSBs of x-axis threshold.	0x0	R/W

## X-AXIS OF ACTIVITY THRESHOLD REGISTER, LSB

Address: 0x24, Reset: 0x00, Name: THRESH\_ACT\_X\_L

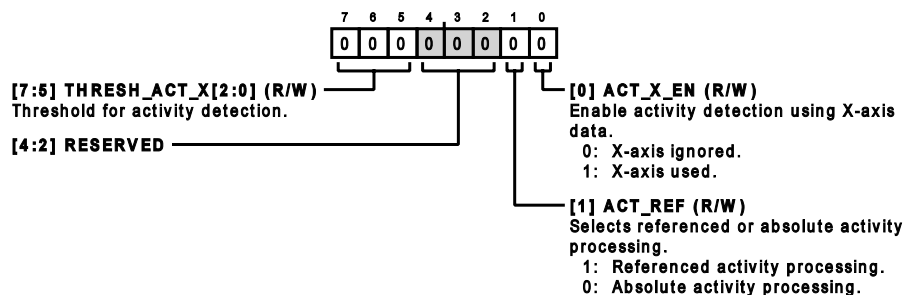

Table 32. Bit Descriptions for THRESH\_ACT\_X\_L

Bits	Bit Name	Settings	Description	Reset	Access
[7:5]	THRESH_ACT_X[2:0]		Threshold for activity detection. The 3 LSBs of x-axis threshold.	0x0	R/W

## REGISTER DETAILS

Table 32. Bit Descriptions for THRESH\_ACT\_X\_L

Bits	Bit Name	Settings	Description	Reset	Access
[4:2]	RESERVED		Reserved.	0x0	R
1	ACT_REF		Selects referenced or absolute activity processing. 1 Referenced activity processing. 0 Absolute activity processing.	0x0	R/W
0	ACT_X_EN		Enable activity detection using X-axis data. 0 X-axis ignored. 1 X-axis used.	0x0	R/W

## Y-AXIS ACTIVITY THRESHOLD REGISTER, MSB

Address: 0x25, Reset: 0x00, Name: THRESH\_ACT\_Y\_H

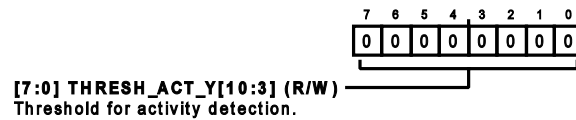

Table 33. Bit Descriptions for THRESH\_ACT\_Y\_H

Bits	Bit Name	Settings	Description	Reset	Access
[7:0]	THRESH_ACT_Y[10:3]		Threshold for activity detection. The 8 MSBs of y-axis threshold.	0x0	R/W

## Y-AXIS OF ACTIVITY THRESHOLD REGISTER, LSB

Address: 0x26, Reset: 0x00, Name: THRESH\_ACT\_Y\_L

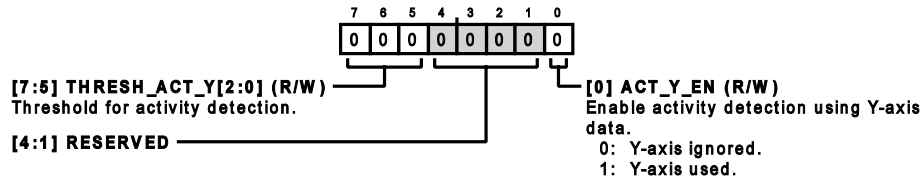

Table 34. Bit Descriptions for THRESH\_ACT\_Y\_L

Bits	Bit Name	Settings	Description	Reset	Access
[7:5]	THRESH_ACT_Y[2:0]		Threshold for activity detection. The 3 LSBs of y-axis threshold.	0x0	R/W
[4:1]	RESERVED		Reserved.	0x0	R
0	ACT_Y_EN		Enable activity detection using Y-axis data. 0 Y-axis ignored. 1 Y-axis used.	0x0	R/W

## Z-AXIS ACTIVITY THRESHOLD REGISTER, MSB

Address: 0x27, Reset: 0x00, Name: THRESH\_ACT\_Z\_H

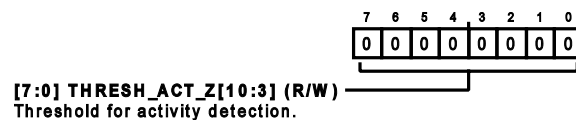

Table 35. Bit Descriptions for THRESH\_ACT\_Z\_H

Bits	Bit Name	Settings	Description	Reset	Access
[7:0]	THRESH_ACT_Z[10:3]		Threshold for activity detection. The 8 MSBs of z-axis threshold.	0x0	R/W

## REGISTER DETAILS

## Z-AXIS OF ACTIVITY THRESHOLD REGISTER, LSB

Address: 0x28, Reset: 0x00, Name: THRESH\_ACT\_Z\_L

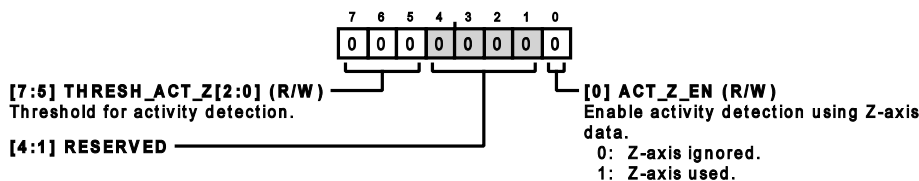

Table 36. Bit Descriptions for THRESH\_ACT\_Z\_L

Bits	Bit Name	Settings	Description	Reset	Access
[7:5]	THRESH_ACT_Z[2:0]		Threshold for activity detection. The 3 LSBs of z-axis threshold.	0x0	R/W
[4:1]	RESERVED		Reserved.	0x0	R
0	ACT_Z_EN		Enable activity detection using Z-axis data. 0 Z-axis ignored. 1 Z-axis used.	0x0	R/W

## ACTIVITY TIME REGISTER

Address: 0x29, Reset: 0x00, Name: TIME\_ACT

The activity timer implements a robust activity detection that minimizes false positive motion triggers. When the timer is used, only sustained motion can trigger activity detection. The time (in milliseconds) is given by the following equation:

$$Time = TIME\_ACT \times 4.125 \text{ ms per code}$$

where:

$TIME\_ACT$  is the value set in this register.

4.125 ms per code is the scale factor of the  $TIME\_ACT$  register for ODR = 5120 Hz. It is 8.25 ms per code for ODR = 2560 Hz and lower. See the [Activity Timer](#) section for more information.

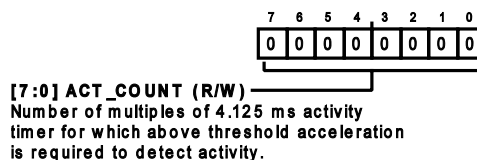

Table 37. Bit Descriptions for TIME\_ACT

Bits	Bit Name	Settings	Description	Reset	Access
[7:0]	ACT_COUNT		Number of multiples of 4.125 ms activity timer for which above threshold acceleration is required to detect activity. It is 4.125 ms per code for 5120 Hz ODR, and it is 8.25 ms per code for 2560 Hz ODR and lower.	0x0	R/W

## X-AXIS INACTIVITY THRESHOLD REGISTER, MSB

Address: 0x2A, Reset: 0x00, Name: THRESH\_INACT\_X\_H

This 11-bit unsigned value sets the threshold for inactivity detection. This value is set in codes, and the scale factor is 100 mg per code. To detect inactivity, the absolute value of the 12-bit acceleration data is compared with the 11-bit (unsigned) inactivity threshold value. The THRESH\_INACT\_X\_L register contains the least significant bits, and the THRESH\_INACT\_X\_H register contains the most significant byte of the inactivity threshold value.



## REGISTER DETAILS

Table 38. Bit Descriptions for THRESH\_INACT\_X\_H

Bits	Bit Name	Settings	Description	Reset	Access
[7:0]	THRESH_INACT_X[10:3]		Threshold for inactivity detection. The 8 MSBs of x-axis.	0x0	R/W

## X-AXIS OF INACTIVITY THRESHOLD REGISTER, LSB

Address: 0x2B, Reset: 0x00, Name: THRESH\_INACT\_X\_L

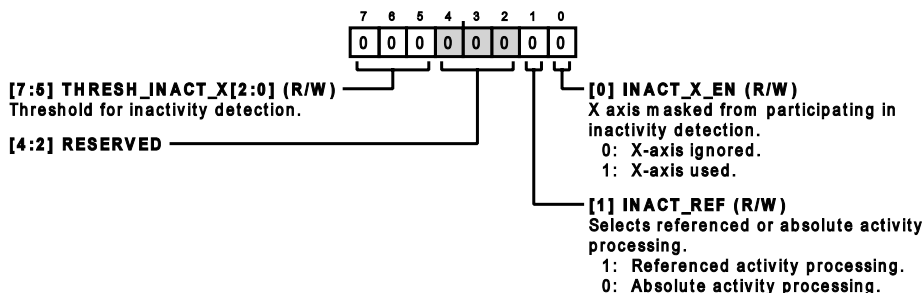

Table 39. Bit Descriptions for THRESH\_INACT\_X\_L

Bits	Bit Name	Settings	Description	Reset	Access
[7:5]	THRESH_INACT_X[2:0]		Threshold for inactivity detection. The 3 LSBs of the x-axis.	0x0	R/W
[4:2]	RESERVED		Reserved.	0x0	R
1	INACT_REF		Selects referenced or absolute inactivity processing. 1 Referenced inactivity processing. 0 Absolute inactivity processing.	0x0	R/W
0	INACT_X_EN		X-axis masked from participating in inactivity detection. 0 X-axis ignored. 1 X-axis used.	0x0	R/W

## Y-AXIS INACTIVITY THRESHOLD REGISTER, MSB

Address: 0x2C, Reset: 0x00, Name: THRESH\_INACT\_Y\_H

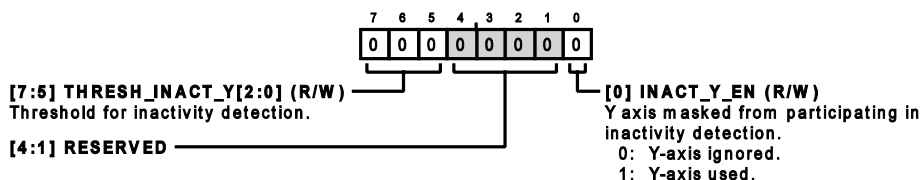

Table 40. Bit Descriptions for THRESH\_INACT\_Y\_H

Bits	Bit Name	Settings	Description	Reset	Access
[7:0]	THRESH_INACT_Y[10:3]		Threshold for inactivity detection. The 8 MSBs of the y-axis.	0x0	R/W

## Y-AXIS OF INACTIVITY THRESHOLD REGISTER, LSB

Address: 0x2D, Reset: 0x00, Name: THRESH\_INACT\_Y\_L



## REGISTER DETAILS

Table 41. Bit Descriptions for THRESH\_INACT\_Y\_L

Bits	Bit Name	Settings	Description	Reset	Access
[7:5]	THRESH_INACT_Y[2:0]		Threshold for inactivity detection. The 3 LSBs of the y-axis.	0x0	R/W
[4:1]	RESERVED		Reserved.	0x0	R
0	INACT_Y_EN		Y-axis masked from participating in inactivity detection.	0x0	R/W
		0	Y-axis ignored.		
		1	Y-axis used.		

## Z-AXIS INACTIVITY THRESHOLD REGISTER, MSB

Address: 0x2E, Reset: 0x00, Name: THRESH\_INACT\_Z\_H



Table 42. Bit Descriptions for THRESH\_INACT\_Z\_H

Bits	Bit Name	Settings	Description	Reset	Access
[7:0]	THRESH_INACT_Z[10:3]		Threshold for inactivity detection. The 8 MSBs of the z-axis.	0x0	R/W

## Z-AXIS OF INACTIVITY THRESHOLD REGISTER, LSB

Address: 0x2F, Reset: 0x00, Name: THRESH\_INACT\_Z\_L

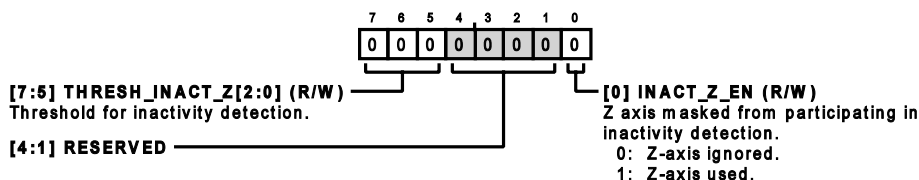

Table 43. Bit Descriptions for THRESH\_INACT\_Z\_L

Bits	Bit Name	Settings	Description	Reset	Access
[7:5]	THRESH_INACT_Z[2:0]		Threshold for inactivity detection. The 3 LSBs of the z-axis.	0x0	R/W
[4:1]	RESERVED		Reserved.	0x0	R
0	INACT_Z_EN		Z-axis masked from participating in inactivity detection.	0x0	R/W
		0	Z-axis ignored.		
		1	Z-axis used.		

## INACTIVITY TIME REGISTERS

The 16-bit value in these registers sets the time that all enabled axes must be lower than the inactivity threshold for an inactivity event to be detected. The TIME\_INACT\_L register holds the eight LSBs, and the TIME\_INACT\_H register holds the eight MSBs of the 16-bit TIME\_INACT value.

Calculate the time as follows:

$$Time = TIME\_INACT \times 32.5 \text{ ms per code}$$

where:

TIME\_INACT is the 16-bit value set by the TIME\_INACT\_L register (eight LSBs) and the TIME\_INACT\_H register (eight MSBs).

32.5 ms per code is the scale factor of the TIME\_INACT\_L and TIME\_INACT\_H registers for 2560 Hz and lower. It is 16.25 ms per code of ODR = 5120 Hz. See the [Inactivity Timer](#) section for more information.



## REGISTER DETAILS

## INACTIVITY TIMER REGISTER, MSB

Address: 0x30, Reset: 0x00, Name: TIME\_INACT\_H

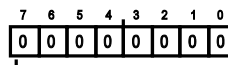

**[7:0] INACT\_COUNT[15:8] (R/W)**  
 Number of multiples of 32.5 ms inactivity timer below which the threshold acceleration is required to detect inactivity

Table 44. Bit Descriptions for TIME\_INACT\_H

Bits	Bit Name	Settings	Description	Reset	Access
[7:0]	INACT_COUNT[15:8]		Number of multiples of 32.5 ms inactivity timer below which the threshold acceleration is required to detect inactivity. It is 32.5 ms per code for 2560 Hz ODR and lower, and it is 16.25 ms per code for 5120 Hz ODR.	0x0	R/W

## INACTIVITY TIMER REGISTER, LSB

Address: 0x31, Reset: 0x00, Name: TIME\_INACT\_L

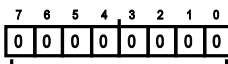

**[7:0] INACT\_COUNT[7:0] (R/W)**  
 Number of multiples of 32.5 ms inactivity timer below which the threshold acceleration is required to detect inactivity

Table 45. Bit Descriptions for TIME\_INACT\_L

Bits	Bit Name	Settings	Description	Reset	Access
[7:0]	INACT_COUNT[7:0]		Number of multiples of 32.5 ms inactivity timer below which the threshold acceleration is required to detect inactivity.	0x0	R/W

## X-AXIS MOTION WARNING THRESHOLD REGISTER, MSB

Address: 0x32, Reset: 0x00, Name: THRESH\_ACT2\_X\_H

This 11-bit unsigned value sets the threshold for motion detection. This value is set in codes, and the scale factor is 100 mg per code. To detect motion, the absolute value of the 12-bit acceleration data is compared with the 11-bit (unsigned) ACTIVITY2 threshold value. The THRESH\_ACT2\_X\_L register contains the least significant bits, and the THRESH\_ACT2\_X\_H register contains the most significant byte of the ACTIVITY2 threshold value.

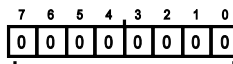

**[7:0] THRESH\_ACT2\_X[10:3] (R/W)**  
 OTN Threshold.

Table 46. Bit Descriptions for THRESH\_ACT2\_X\_H

Bits	Bit Name	Settings	Description <sup>1</sup>	Reset	Access
[7:0]	THRESH_ACT2_X[10:3]		OTN Threshold. The 8 MSBs of the x-axis threshold for motion warning interrupt.	0x0	R/W

<sup>1</sup> OTN stands for other threshold notification.

## X-AXIS OF MOTION WARNING NOTIFICATION REGISTER, LSB

Address: 0x33, Reset: 0x00, Name: THRESH\_ACT2\_X\_L

REGISTER DETAILS

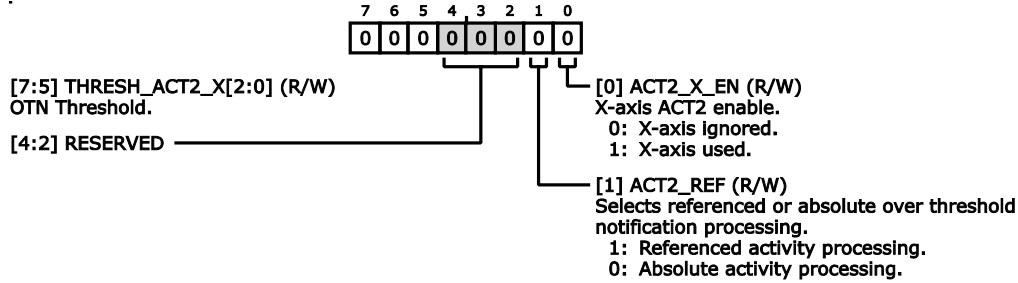

Table 47. Bit Descriptions for THRESH\_ACT2\_X\_L

Bits	Bit Name	Settings	Description	Reset	Access
[7:5]	THRESH_ACT2_X[2:0]		OTN Threshold. The 3 LSBs of the x-axis threshold for motion warning interrupt.	0x0	R/W
[4:2]	RESERVED		Reserved.	0x0	R
1	ACT2_REF		Selects referenced or absolute over threshold notification processing. 1 Referenced activity processing. 0 Absolute activity processing.	0x0	R/W
0	ACT2_X_EN		X-axis ACT2 enable. When set to 1, the x-axis participates in motion warning notification detection. 0 X-axis ignored. 1 X-axis used.	0x0	R/W

Y-AXIS MOTION WARNING NOTIFICATION THRESHOLD REGISTER, MSB

Address: 0x34, Reset: 0x00, Name: THRESH\_ACT2\_Y\_H

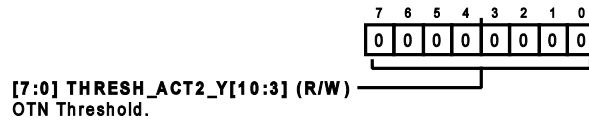

Table 48. Bit Descriptions for THRESH\_ACT2\_Y\_H

Bits	Bit Name	Settings	Description	Reset	Access
[7:0]	THRESH_ACT2_Y[10:3]		OTN Threshold. The 8 MSBs of the y-axis threshold for motion warning interrupt.	0x0	R/W

Y-AXIS OF MOTION WARNING NOTIFICATION REGISTER, LSB

Address: 0x35, Reset: 0x00, Name: THRESH\_ACT2\_Y\_L

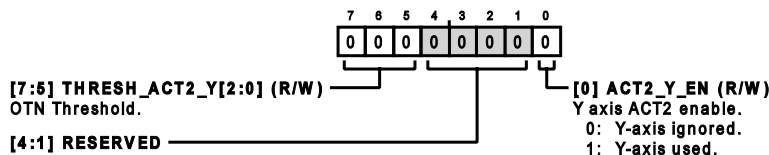

Table 49. Bit Descriptions for THRESH\_ACT2\_Y\_L

Bits	Bit Name	Settings	Description	Reset	Access
[7:5]	THRESH_ACT2_Y[2:0]		OTN Threshold. The 3 LSBs of the y-axis threshold for motion warning interrupt.	0x0	R/W
[4:1]	RESERVED		Reserved.	0x0	R
0	ACT2_Y_EN		Y-axis ACT2 enable. When 1, the y-axis participates in motion warning notification detection. 0 Y-axis ignored. 1 Y-axis used.	0x0	R/W

## REGISTER DETAILS

## Z-AXIS MOTION WARNING NOTIFICATION THRESHOLD REGISTER, MSB

Address: 0x36, Reset: 0x00, Name: THRESH\_ACT2\_Z\_H

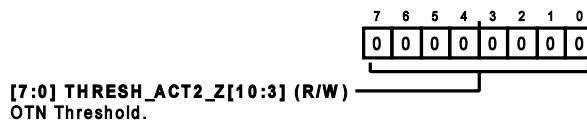

Table 50. Bit Descriptions for THRESH\_ACT2\_Z\_H

Bits	Bit Name	Settings	Description	Reset	Access
[7:0]	THRESH_ACT2_Z[10:3]		OTN Threshold. The 8 MSBs of the z-axis threshold for motion warning interrupt.	0x0	R/W

## Z-AXIS MOTION WARNING NOTIFICATION REGISTER, LSB

Address: 0x37, Reset: 0x00, Name: THRESH\_ACT2\_Z\_L

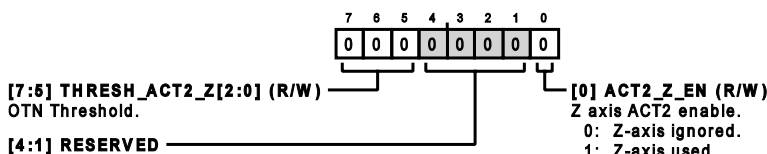

Table 51. Bit Descriptions for THRESH\_ACT2\_Z\_L

Bits	Bit Name	Settings	Description	Reset	Access
[7:5]	THRESH_ACT2_Z[2:0]		OTN Threshold. The 3 LSBs of the z-axis threshold for motion warning interrupt.	0x0	R/W
[4:1]	RESERVED		Reserved.	0x0	R
0	ACT2_Z_EN		Z-axis ACT2 enable. When 1, the z-axis participates in motion warning notification detection. 0 Z-axis ignored. 1 Z-axis used.	0x0	R/W

## HIGH-PASS FILTER SETTINGS REGISTER

Address: 0x38, Reset: 0x00, Name: HPF

Use this register to specify parameters for the internal high-pass filter.

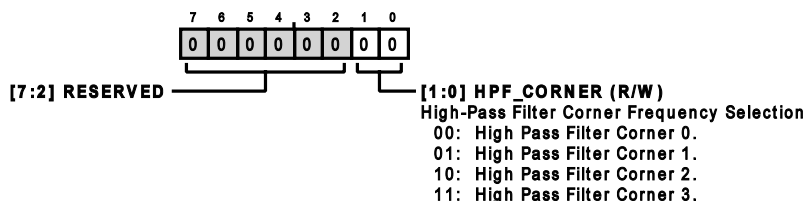

Table 52. Bit Descriptions for HPF

Bits	Bit Name	Settings	Description	Reset	Access
[7:2]	RESERVED		Reserved.	0x0	R
[1:0]	HPF_CORNER		High-Pass Filter Corner Frequency Selection. 00 High-Pass Filter Corner 0. At ODR 5120 Hz = 30.48 Hz, at ODR 2560 Hz = 15.24 Hz, at ODR 1280 Hz = 7.61 Hz, at ODR 640 Hz = 3.81 Hz, and at ODR 320 Hz = 1.90 Hz. 01 High-Pass Filter Corner 1. At ODR 5120 Hz = 15.58 Hz, at ODR 2560 Hz = 7.79 Hz, at ODR 1280 Hz = 3.89 Hz, at ODR 640 Hz = 1.94 Hz, and at ODR 320 Hz = 0.97 Hz. 10 High-Pass Filter Corner 2. At ODR 5120 Hz = 7.88 Hz, at ODR 2560 Hz = 3.94 Hz, at ODR 1280 Hz = 1.97 Hz, at ODR 640 Hz = 0.98 Hz, and at ODR 320 Hz = 0.49 Hz.	0x0	R/W

## REGISTER DETAILS

Table 52. Bit Descriptions for HPF

Bits	Bit Name	Settings	Description	Reset	Access
		11	High-Pass Filter Corner 3. At ODR 5120 Hz = 3.96 Hz, at ODR 2560 Hz = 1.98 Hz, at ODR 1280 Hz = 0.99 Hz, at ODR 640 Hz = 0.49 Hz, and at ODR 320 Hz = 0.24 Hz.		

## FIFO SAMPLES REGISTER

Address: 0x39, Reset: 0x80, Name: FIFO\_SAMPLES

Use the FIFO\_SAMPLES value to specify the number of samples to store in the FIFO. The 8 least significant bits (LSBs) of the FIFO\_SAMPLES value are stored in this register. The most significant bit (MSB) of the FIFO\_SAMPLES value is Bit 0 of the FIFO\_CTL register.

The default value of this register is 0x80 to avoid triggering the FIFO watermark interrupt (see the [FIFO Watermark](#) section for more information). In trigger FIFO mode, FIFO\_SAMPLES program the number of samples to be saved after the trigger is detected.

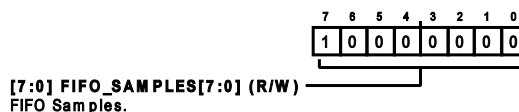

Table 53. Bit Descriptions for FIFO\_SAMPLES

Bits	Bit Name	Settings	Description	Reset	Access
[7:0]	FIFO_SAMPLES[7:0]		FIFO Samples. Watermark number of FIFO samples that triggers a FIFO_FULL condition when reached. Values range from 0 to 512.	0x80	R/W

## FIFO CONTROL REGISTER

Address: 0x3A, Reset: 0x00, Name: FIFO\_CTL

Use this register to specify the operating parameters for the FIFO.

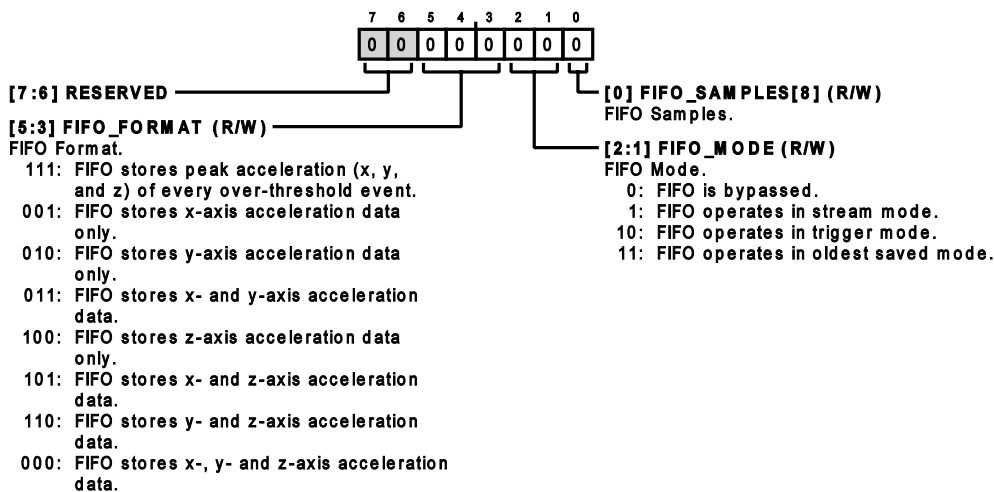

Table 54. Bit Descriptions for FIFO\_CTL

Bits	Bit Name	Settings	Description	Reset	Access
[7:6]	RESERVED		Reserved.	0x0	R
[5:3]	FIFO_FORMAT		FIFO Format. Specifies which data is stored in the FIFO buffer. 111 FIFO stores peak acceleration (x, y, and z) of every over threshold event. 001 FIFO stores x-axis acceleration data only. 010 FIFO stores y-axis acceleration data only.	0x0	R/W

## REGISTER DETAILS

Table 54. Bit Descriptions for FIFO\_CTL

Bits	Bit Name	Settings	Description	Reset	Access
		011	FIFO stores x- and y-axis acceleration data.		
		100	FIFO stores z-axis acceleration data only.		
		101	FIFO stores x- and z-axis acceleration data.		
		110	FIFO stores y- and z-axis acceleration data.		
		000	FIFO stores x-, y- and z-axis acceleration data.		
[2:1]	FIFO_MODE		FIFO Mode. Specifies FIFO operating mode. 0 FIFO is bypassed. 1 FIFO operates in stream mode. 10 FIFO operates in trigger mode. 11 FIFO operates in oldest saved mode.	0x0	R/W
0	FIFO_SAMPLES[8]		FIFO Samples. Watermark number of FIFO samples that triggers a FIFO_FULL condition when reached. Values range from 0 to 512.	0x0	R/W

## INTERRUPT PIN FUNCTION MAP REGISTERS

Address: 0x3B, Reset: 0x00, Name: INT1\_MAP

The INT1\_MAP and INT2\_MAP registers configure the INT1 and INT2 interrupt pins, respectively. Bits[6:0] select which function(s) generate an interrupt on the pin. If its corresponding bit is set to 1, the function generates an interrupt on the INTx pin. Bit B7 configures whether the pin operates in active high (B7 low) or active low (B7 high) mode. Any number of functions can be selected simultaneously for each pin. If multiple functions are selected, their conditions are OR'ed together to determine the INTx pin state. The status of each function can be determined by reading the status register. If no interrupts are mapped to an INTx pin, the pin remains in a high impedance state.

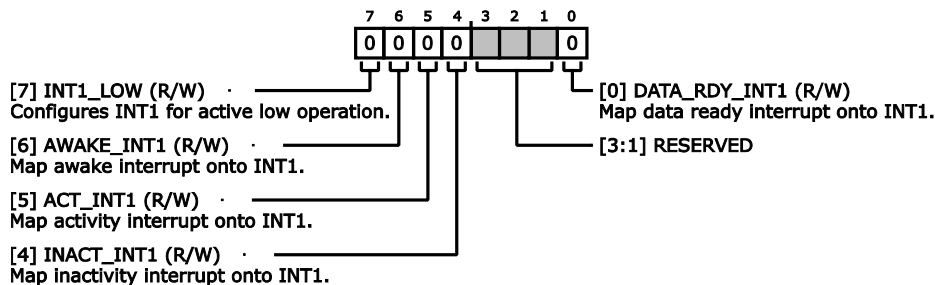

Table 55. Bit Descriptions for INT1\_MAP

Bits	Bit Name	Settings	Description	Reset	Access
7	INT1_LOW		Configures INT1 for active low operation.	0x0	R/W
6	AWAKE_INT1		Map awake interrupt onto INT1.	0x0	R/W
5	ACT_INT1		Map activity interrupt onto INT1.	0x0	R/W
4	INACT_INT1		Map inactivity interrupt onto INT1.	0x0	R/W
[3:1]	RESERVED		Reserved.	0x0	R
0	DATA_RDY_INT1		Map data ready interrupt onto INT1.	0x0	R/W

## INT2 FUNCTION MAP REGISTER

Address: 0x3C, Reset: 0x00, Name: INT2\_MAP

REGISTER DETAILS

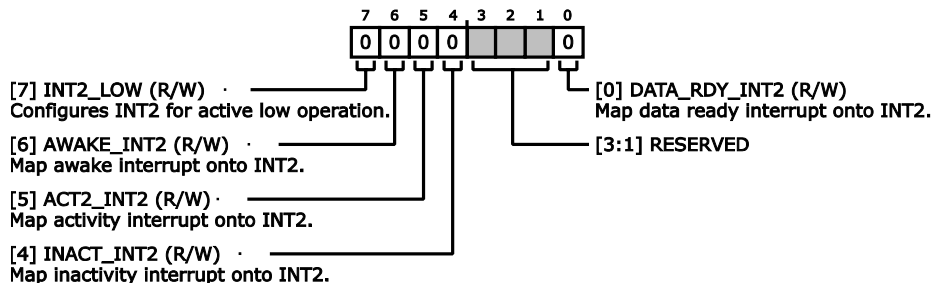

Table 56. Bit Descriptions for INT2\_MAP

Bits	Bit Name	Settings	Description	Reset	Access
7	INT2_LOW		Configures INT2 for active low operation.	0x0	R/W
6	AWAKE_INT2		Map awake interrupt onto INT2.	0x0	R/W
5	ACT2_INT2		Map activity interrupt onto INT2.	0x0	R/W
4	INACT_INT2		Map inactivity interrupt onto INT2.	0x0	R/W
[3:1]	RESERVED		Reserved.	0x0	R
0	DATA_RDY_INT2		Map data ready interrupt onto INT2.	0x0	R/W

EXTERNAL TIMING CONTROL REGISTER

Address: 0x3D, Reset: 0x00, Name: TIMING

Use this register to control the ADXL371 timing parameters: ODR and external timing triggers.

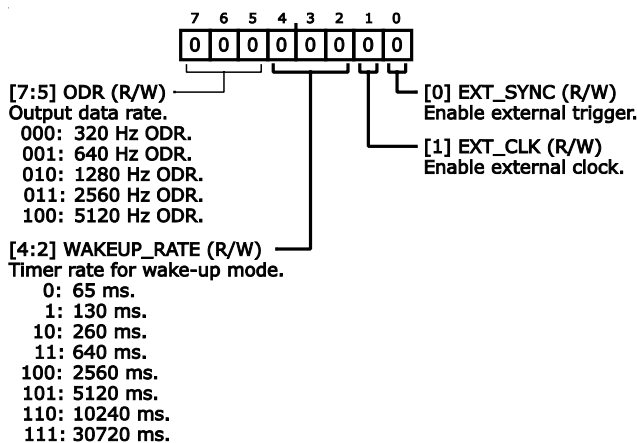

Table 57. Bit Descriptions for TIMING

Bits	Bit Name	Settings	Description	Reset	Access
[7:5]	ODR		Output data rate. 000 320 Hz ODR. 001 640 Hz ODR. 010 1280 Hz ODR. 011 2560 Hz ODR. 100 5120 Hz ODR.	0x0	R/W
[4:2]	WAKEUP_RATE		Timer rate for wake-up mode. 0 65 ms. 1 130 ms.	0x0	R/W

## REGISTER DETAILS

Table 57. Bit Descriptions for TIMING

Bits	Bit Name	Settings	Description	Reset	Access
			10 260 ms. 11 640 ms. 100 2560 ms. 101 5120 ms. 110 10240 ms. 111 30720 ms.		
1	EXT_CLK		Enable external clock.	0x0	R/W
0	EXT_SYNC		Enable external trigger.	0x0	R/W

## MEASUREMENT CONTROL REGISTER

Address: 0x3E, Reset: 0x00, Name: MEASURE

Use this register to control several measurement settings.

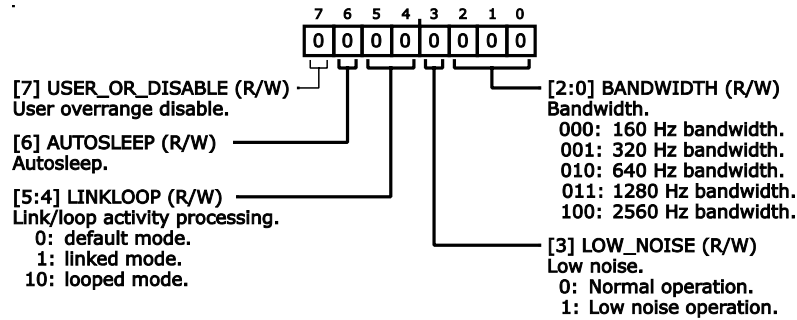

Table 58. Bit Descriptions for MEASURE

Bits	Bit Name	Settings	Description	Reset	Access
7	USER_OR_DISABLE		User overrange disable.	0x0	R/W
6	AUTOSLEEP		Autosleep. When set to 1, autosleep is enabled, and the device enters wake-up mode automatically upon detection of inactivity. Activity and inactivity detection must be in linked mode or loop mode (the LINKLOOP bits in the MEASURE register) to enable autosleep. Otherwise, the bit is ignored.	0x0	R/W
[5:4]	LINKLOOP		Link/loop activity processing. These bits select how activity and inactivity processing are linked. 0 Default mode. Activity and inactivity detection, when enabled, operate simultaneously and their interrupts (if mapped) must be acknowledged by the host processor by reading the STATUS register. Autosleep is disabled in this mode. 1 Linked mode. Activity and inactivity detection are linked sequentially so that only one is enabled at a time. Their interrupts (if mapped) must be acknowledged by the host processor by reading the STATUS register. 10 Looped mode. Activity and inactivity detection are linked sequentially so that only one is enabled at a time, and their interrupts are internally acknowledged (do not need to be serviced by the host processor). To use either linked or looped mode, both ACT_x_EN and INACT_x_EN must be set to 1. Otherwise, the default mode is used. For additional information, refer to the <a href="#">Linking Activity and Inactivity Detection</a> section.	0x0	R/W
3	LOW_NOISE		Low noise. Selects low noise operation. 0 Normal operation. Device operates at the normal noise level and ultralow current consumption 1 Low noise operation. Device operates at ~1/3 the normal noise level.	0x0	R/W
[2:0]	BANDWIDTH		Bandwidth. Select the desired output signal bandwidth. A four-pole low-pass filter at the selected frequency limits the signal bandwidth. 000 160 Hz bandwidth. 001 320 Hz bandwidth.	0x0	R/W

## REGISTER DETAILS

Table 58. Bit Descriptions for MEASURE

Bits	Bit Name	Settings	Description	Reset	Access
		010	640 Hz bandwidth.		
		011	1280 Hz bandwidth.		
		100	2560 Hz bandwidth.		

## POWER CONTROL REGISTER

Address: 0x3F, Reset: 0x00, Name: POWER\_CTL

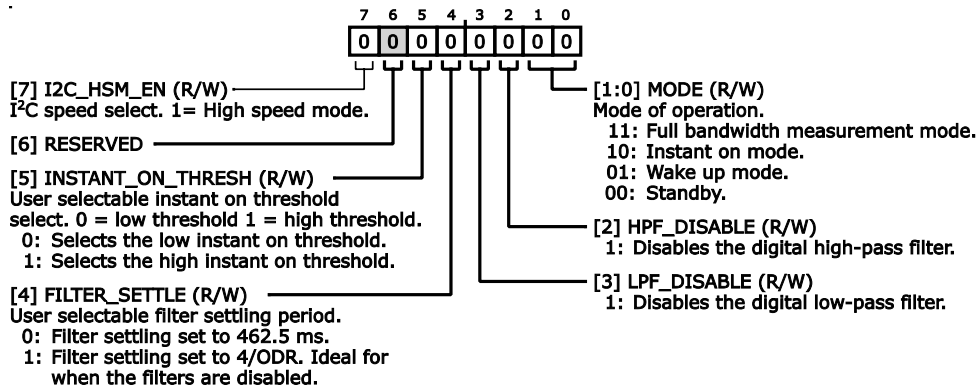

Table 59. Bit Descriptions for POWER\_CTL

Bits	Bit Name	Settings	Description	Reset	Access
7	I2C_HSM_EN		I <sup>2</sup> C speed select. 1 = High speed mode.	0x0	R/W
6	RESERVED		Reserved.	0x0	R
5	INSTANT_ON_THRESH		User selectable instant on threshold select. 0 = low threshold, 1 = high threshold. 0 Selects the low instant on threshold. 1 Selects the high instant on threshold.	0x0	R/W
4	FILTER_SETTLE		User selectable filter settling period. 0 Filter settling set to 462.5 ms. 1 Filter settling set to 4/ODR. Ideal for when the filters are disabled.	0x0	R/W
3	LPF_DISABLE		1 Disables the low-pass filter.	0x0	R/W
2	HPF_DISABLE		1 Disables the digital high-pass filter.	0x0	R/W
[1:0]	MODE		Mode of operation. 11 Full bandwidth measurement mode. 10 Instant on mode. 01 Wake up mode. 00 Standby.	0x0	R/W

## SELF TEST REGISTER

Address: 0x40, Reset: 0x00, Name: SELF\_TEST

Refer to the [Self Test](#) section for information on the operation of the self test feature, and see the [Self Test Procedure](#) section for guidelines on how to use this functionality.



## REGISTER DETAILS

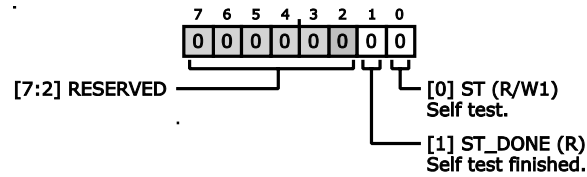

Table 60. Bit Descriptions for SELF\_TEST

Bits	Bit Name	Settings	Description	Reset	Access
[7:2]	RESERVED		Reserved.	0x0	R
1	ST_DONE		Self test finished.	0x0	R
0	ST		Self test. Writing a 1 to this bit initiates self test. Writing a 0 clears self test.	0x0	R/W

## RESET (CLEARS) REGISTER, PART IN STANDBY MODE

Address: 0x41, Reset: 0x00, Name: RESET

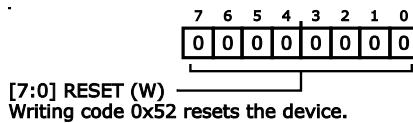

Table 61. Bit Descriptions for RESET

Bits	Bit Name	Settings	Description	Reset	Access
[7:0]	RESET		Writing code 0x52 resets the device.	0x0	W

## FIFO ACCESS REGISTER

Address: 0x42, Reset: 0x00, Name: FIFO\_DATA

Read this register to access data stored in the FIFO.

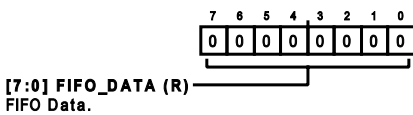

Table 62. Bit Descriptions for FIFO\_DATA

Bits	Bit Name	Settings	Description	Reset	Access
[7:0]	FIFO_DATA		FIFO Data. A read to this address pops a 2-byte word of axis data from the FIFO. FIFO data is formatted to 2 bytes (16 bits), most significant byte first. Two subsequent reads complete the transaction of this data onto the interface. Continued reading of this field continues to pop the FIFO every third read. Multibyte reads to this address do not increment the address pointer. If this address is read due to an auto-increment from the previous address, it does not pop the FIFO. It returns zeros and increment on to the next address.	0x0	R

## APPLICATIONS INFORMATION

## APPLICATION EXAMPLES

This section includes application circuits highlighting useful features of the ADXL371.

## Power Supply Decoupling

Figure 50 shows the recommended bypass capacitors for use with the ADXL371.

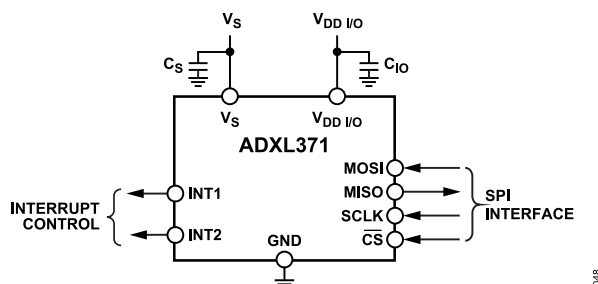

Figure 50. Recommended Bypass Capacitors

A 0.1  $\mu\text{F}$  ceramic capacitor ( $C_S$ ) at  $V_S$  and a 0.1  $\mu\text{F}$  ceramic capacitor ( $C_{IO}$ ) at  $V_{DD I/O}$  placed as close as possible to the ADXL371 supply pins are recommended to adequately decouple the accelerometer from noise on the power supply. It is recommended that  $V_S$  and  $V_{DD I/O}$  be separate supplies to minimize digital clocking noise on the  $V_S$  supply. If separating  $V_S$  and  $V_{DD I/O}$  is not possible, additional filtering of the supplies may be necessary.

If additional decoupling is necessary, a resistor or ferrite bead, no larger than 100  $\Omega$ , in series with  $V_S$ , is recommended. Additionally, increasing the bypass capacitance on  $V_S$  to a 1  $\mu\text{F}$  tantalum capacitor in parallel with a 0.1  $\mu\text{F}$  ceramic capacitor may also improve noise.

Ensure that the connection from the ADXL371 ground to the power supply ground has low impedance because noise transmitted through ground has an effect similar to noise transmitted through  $V_S$ .

## Power Supply Requirements

The ADXL371 operates using supply voltage rails ranging from 2.5 V to 3.5 V. The operating voltage range ( $V_S$ ) specified in Table 1 ranges from 2.5 V to 3.5 V to account for inaccuracies and transients of up to  $\pm 10\%$  on the supply voltage.

When power cycling the ADXL371, it is highly recommended to fully discharge the device to ground level ( $V_S = 0\text{ V}$ ) on each power cycle. If this is not possible, care must be taken regarding the following specifications:

- ▶  $V_S$  supply start-up threshold
- ▶ Hold time
- ▶ Rise time

 $V_{\text{RESET}}$ 

During start-up or power cycling of the ADXL371, any time power is removed from the ADXL371 or falls to less than 1.6 V, the  $V_S$  and  $V_{DD I/O}$  supplies must be discharged to a reset voltage ( $V_{\text{RESET}} \leq 100\text{ mV}$ ) before powering back up. The  $V_{\text{RESET}}$  specification is a mandatory requirement.

## Hold Time

The  $V_S$  and  $V_{DD I/O}$  supplies must be held below  $V_{\text{RESET}}$  for at least 200 ms before powering back up.

## Rise Time

For the worst case scenario ( $V_{\text{RESET}} = 100\text{ mV}$  and hold time = 200 ms), the  $V_S$  and  $V_{DD I/O}$  supply rise time must be linear and within 250  $\mu\text{s}$  to reach 1.6 V (see Figure 51).

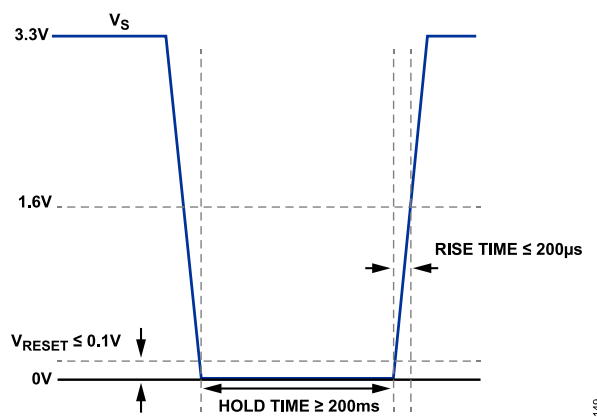

Figure 51. Power Cycling Requirements

Note that fully discharging the power supply to the ground level allows a longer rise time,  $\leq 600\text{ }\mu\text{s}$ , from 0 V to 1.6 V for a 200 ms hold time.

## Using External Timing Triggers

Figure 52 shows an application diagram for using the INT1 pin as the input for an external clock. In this mode, the external clock determines all accelerometer timing, including the output data rate and bandwidth.

Set the EXT\_CLK bit in the TIMING register to enable this feature.

APPLICATIONS INFORMATION

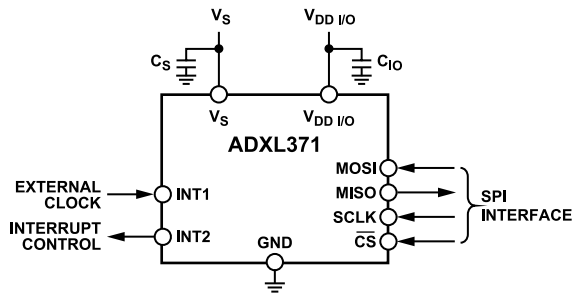

Figure 52. INT1 Pin as Input for External Clock

Figure 53 is an application diagram for using the INT2 pin as a trigger for synchronized sampling. Acceleration samples are produced every time this trigger is activated. Set the EXT\_SYNC bit in the TIMING register to enable this feature.

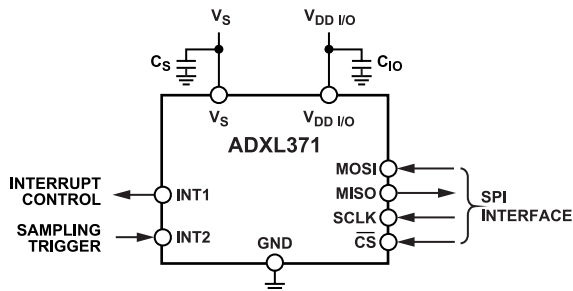

Figure 53. Using the INT2 Pin to Trigger Synchronized Sampling

OPERATION AT VOLTAGES OTHER THAN 3.3 V

The ADXL371 is tested and specified at a supply voltage of  $V_S = 3.3\text{ V}$ . However, it can be powered with a  $V_S$  as high as 3.5 V or as low as 2.5 V. Some performance parameters change as the supply voltage changes, including the supply current, noise, offset, and sensitivity.

OPERATION AT TEMPERATURES OTHER THAN AMBIENT

The ADXL371 is tested and specified at an ambient temperature. However, it is rated for temperatures between  $-40^\circ\text{C}$  and  $+105^\circ\text{C}$ . Some performance parameters change along with temperature, such as offset, sensitivity, clock performance, and current. Some of these temperature variations are characterized in Table 1, and others are shown in the figures within the Typical Performance Characteristics section.

MECHANICAL CONSIDERATIONS FOR MOUNTING

Mount the ADXL371 on the PCB in a location close to a hard mounting point of the PCB to the case. Mounting the ADXL371 at an unsupported PCB location, as shown in Figure 54, can result in large, apparent measurement errors due to undamped PCB vibration. Locating the accelerometer near a hard mounting point ensures that any PCB vibration at the accelerometer is higher than the mechanical sensor resonant frequency of the accelerometer and, therefore, effectively invisible to the accelerometer. Multiple mounting points, close to the sensor, and/or a thicker PCB also help to reduce the effect of system resonance on the performance of the sensor.

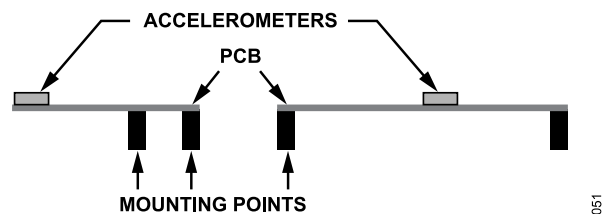

Figure 54. Incorrectly Placed Accelerometers

AXES OF ACCELERATION SENSITIVITY

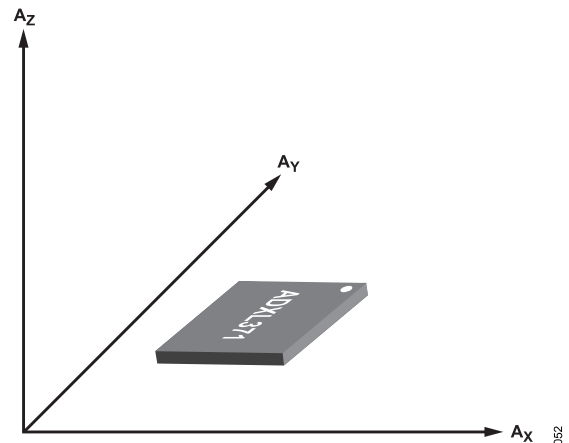

Figure 55. Axes of Acceleration Sensitivity (Corresponding Output Increases when Accelerated Along the Sensitive Axis)

APPLICATIONS INFORMATION

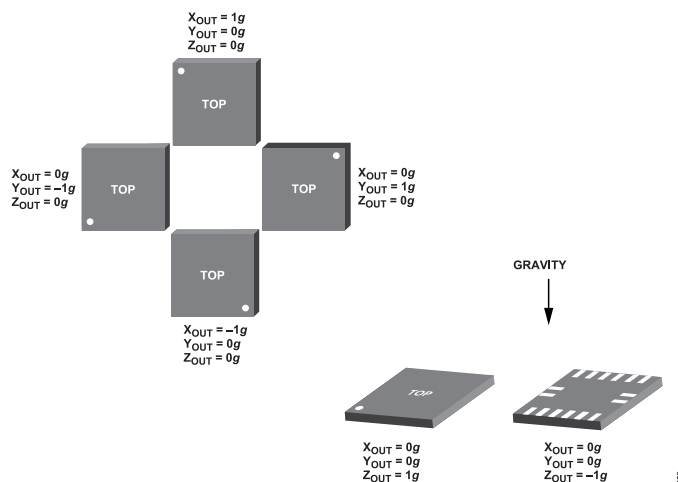

Figure 56. Output Response vs. Orientation to Gravity

LAYOUT AND DESIGN RECOMMENDATIONS

Figure 57 shows the recommended printed wiring board land pattern.

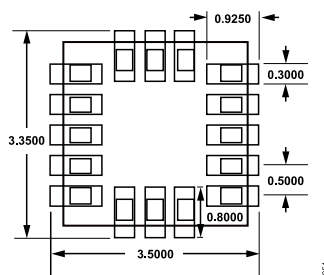

Figure 57. Recommended Printed Wiring Board Land Pattern (Dimensions Shown in Millimeters)

## SILICON ANOMALY

This anomaly list describes the known bugs, anomalies, and workarounds for the ADXL371.

Analog Devices, Inc., is committed, through future silicon revisions, to continuously improving silicon functionality. Analog Devices tries to ensure that these future silicon revisions remain compatible with your present software/systems by implementing the recommended workarounds outlined here.

## ADXL371 FUNCTIONALITY ISSUES

**Table 63. ADXL371 Functionality Issues**

Silicon Revision Identifier	Silicon Status	Anomaly Sheet	Number of Reported Anomalies
REVID = 0xFB	Released	Rev. 0	1

## FUNCTIONALITY ISSUE

**Table 64. FIFO Error [er001]**

<b>Background</b>	Data must be stored in the FIFO as an x, y, z, x, y, z, ... sequence.
<b>Issue</b>	In all FIFO modes, data misalignment occurs. Data may be stored in the FIFO as a y, z, x, y, z, x, ... sequence or a z, x, y, z, x, y, ... sequence.
<b>Workaround</b>	<p>Leverage the external trigger synchronization function to disable the sensor ADC before accessing the FIFO (see <a href="#">Figure 58</a> for an implementation example).</p> <p>To initialize, follow these steps:</p> <ol style="list-style-type: none"> <li>1. Set the desired FIFO mode and other desired configurations.</li> <li>2. Set the timing register (0x3D) to external sync along with the ODR. Do not apply an external trigger signal to INT2 to keep the ADC off.</li> <li>3. Set the device to measurement mode.</li> </ol> <p>For the main loop, follow these steps:</p> <ol style="list-style-type: none"> <li>1. Set the timing register (0x3D) to internal sync along with the ODR.</li> <li>2. Wait for the FIFO_FULL interrupt from INT1.</li> <li>3. Set the timing register (0x3D) to external sync along with the ODR.</li> <li>4. Read the entire contents of the FIFO.</li> <li>5. Clear the FIFO (bypass mode).</li> <li>6. Set the desired FIFO mode.</li> </ol>
<b>Related Issues</b>	None.

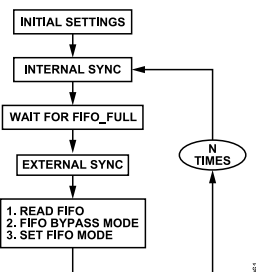

**Figure 58. FIFO Workaround Implementation Example**