

# External Combo Antenna LTE/GPS



AEACBK050048-C2LG



Ø50.0 x 48.0 mm  
RoHS/RoHS II Compliant  
MSL = 1

## Features

- 4G/LTE full band coverage
- Active GPS with LNA gain of 28 dB
- IP66 rated
- Screw mount
- RHCP for GPS antenna

## Applications

- 4G/LTE/3G/2G/GSM applications
- GNSS/GPS
- Telematics
- M2M
- IoT and Industrial IoT
- Geolocation and tracking
- Transportation and agriculture
- Smart city

## Electrical Characteristics

Parameters	Min.	Typ.	Max.	Units	Note
LTE Antenna					
Frequency Range		698-960/1710-2690		MHz	
VSWR			3.0		
Polarization	Linear				
Impedance		50		Ω	
Gain		2.0		dBi	
GPS Antenna					
Center Frequency		1575.42±1		MHz	
Bandwidth		CF±5		MHz	
Polarization		RHCP			
Gain		2		dBic	Zenith
VSWR			1.5		
Impedance		50			
Axial Ratio			3	dB	
LNA					
Gain		28±2		dB	
Noise Figure			1.5	dB	
VSWR			2.0		
Ex-band Attenuation		12		dB	CF+50MHz
		16		dB	CF-50MHz
Supply Voltage	2.2		5.0	V	DC
Current Consumption	5		15	mA	

# External Combo Antenna LTE/GPS

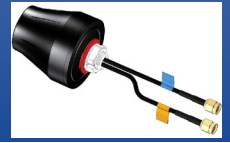

AEACBK050048-C2LG



Ø50.0 x 48.0 mm  
RoHS/RoHS II Compliant  
MSL = 1

## Mechanical Characteristics

Parameters	Description
Connector	SMA Male
Cable Type	RG174
Cable Length	3M
Material	ABS
Mount way	Screw
Dimensions	Φ50.0 x 48.0 mm

## Environmental Characteristics

Parameters	Description
Waterproof	IP66 (excluding cable outlet)
Operating Temperature	-40 ~ +85 °C
Relative Humidity	Up to 95%
MSL Level	1
ROHS Complaint	Yes
Vibration	10 to 55Hz with 1.5mm amplitude 2 hours

# External Combo Antenna LTE/GPS

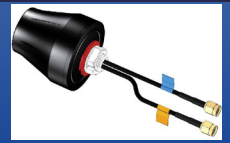

AEACBK050048-C2LG



Ø50.0 x 48.0 mm  
RoHS/RoHS II Compliant  
MSL = 1

## Dimensions

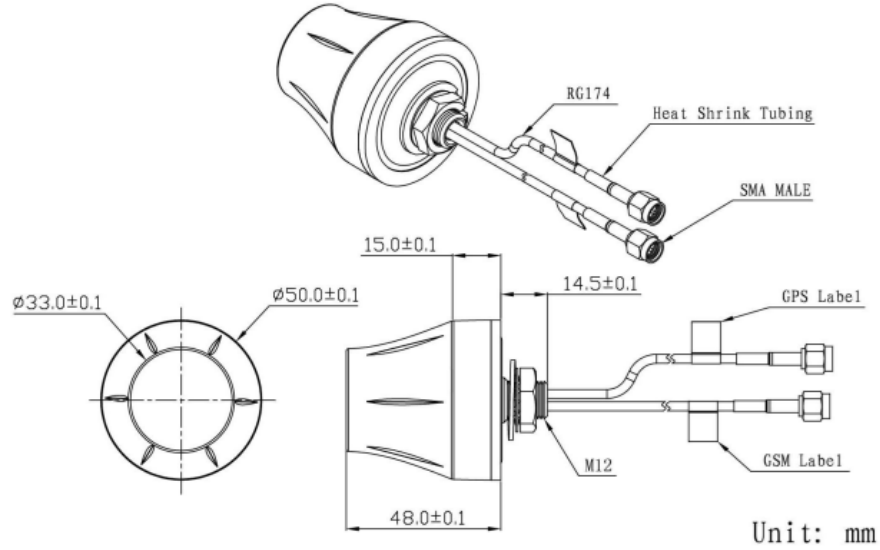

## Product Image



# External Combo Antenna LTE/GPS



AEACBK050048-C2LG



Ø50.0 x 48.0 mm  
RoHS/RoHS II Compliant  
MSL = 1

## VSWR Characteristics

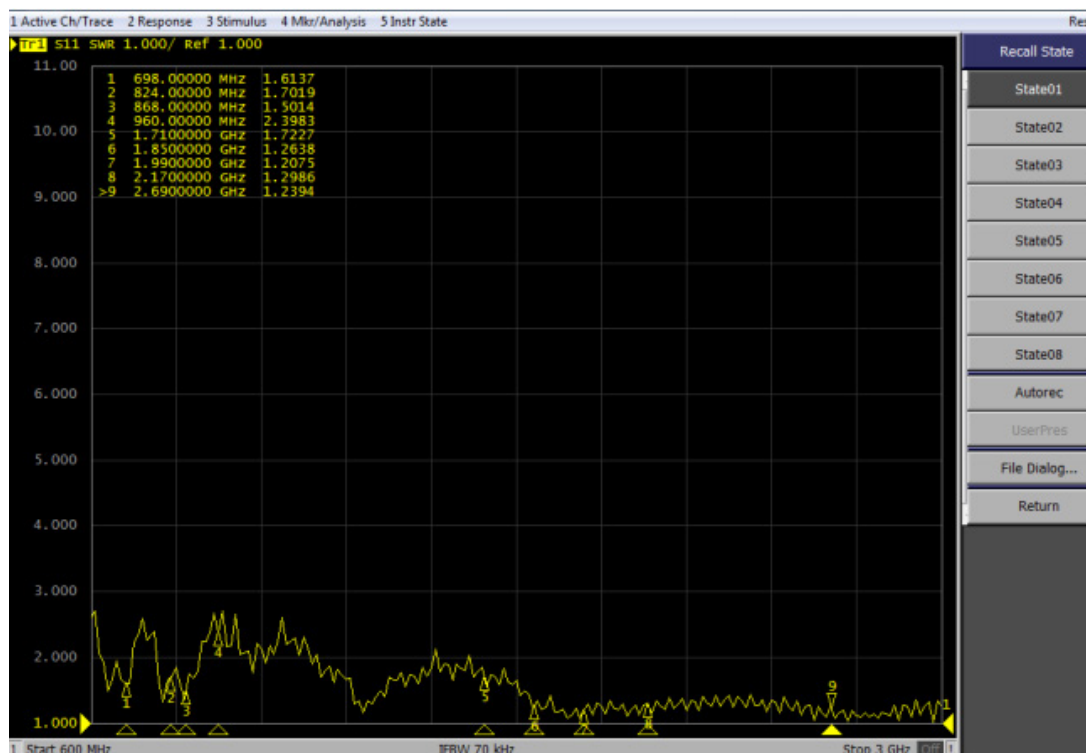

## Gain and Efficiency

Frequency (MHz)	Efficiency	Gain (dBi)
698	0.53	1.05
824	0.65	2.38
868	0.61	1.12
960	0.56	1.0
1710	0.49	0.9
1850	0.52	0.3
1990	0.57	0.73
2170	0.63	1.96
2690	0.53	1.94

# External Combo Antenna LTE/GPS

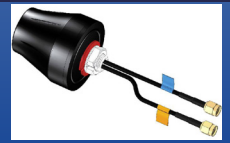

AEACBK050048-C2LG



Ø50.0 x 48.0 mm  
RoHS/RoHS II Compliant  
MSL = 1

## Radiation Patterns

2D Radiation Patterns  
GPS Antenna

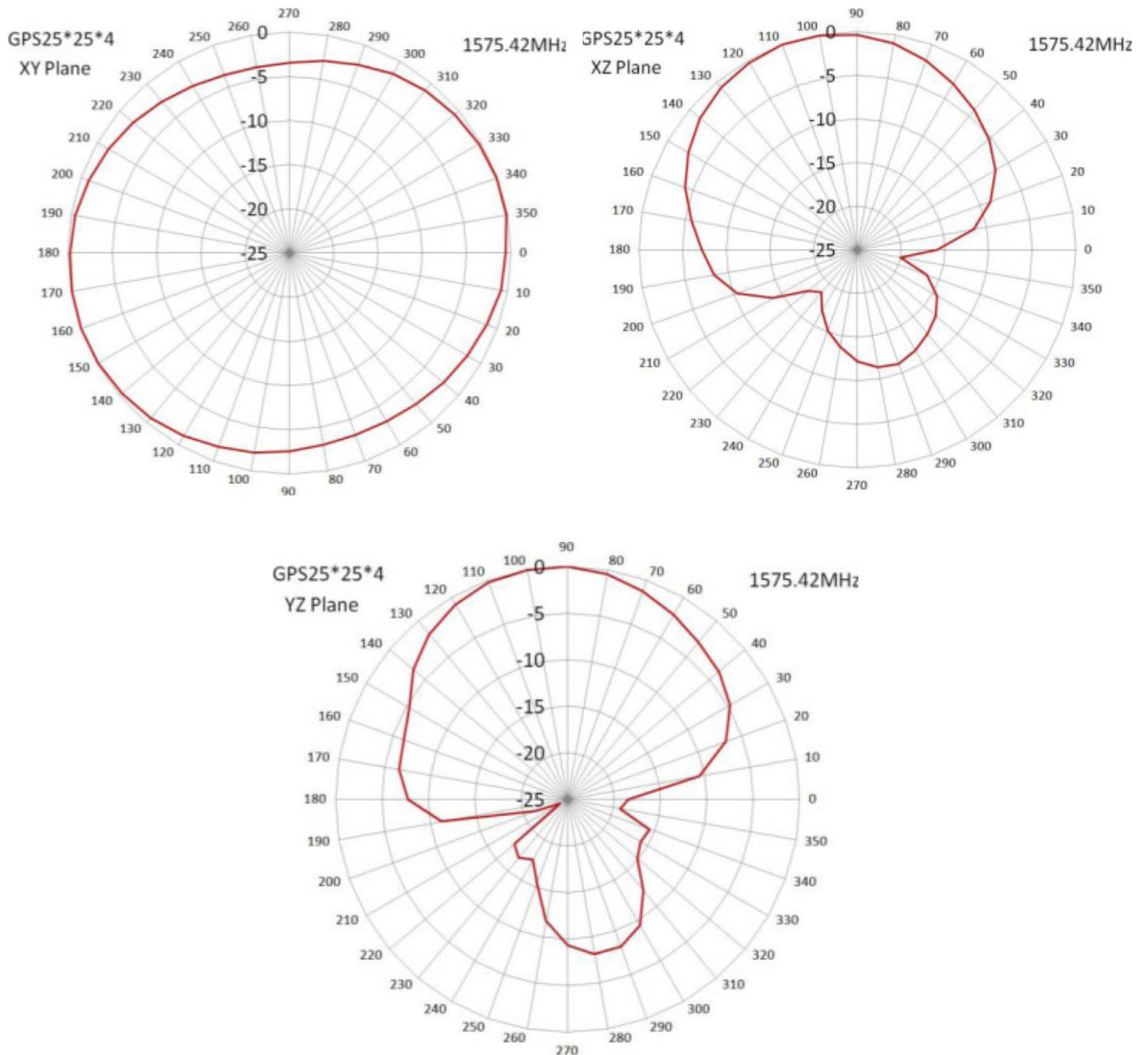

# External Combo Antenna LTE/GPS

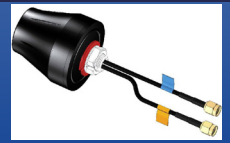

AEACBK050048-C2LG



Ø50.0 x 48.0 mm  
RoHS/RoHS II Compliant  
MSL = 1

## Radiation Patterns

LTE Antenna

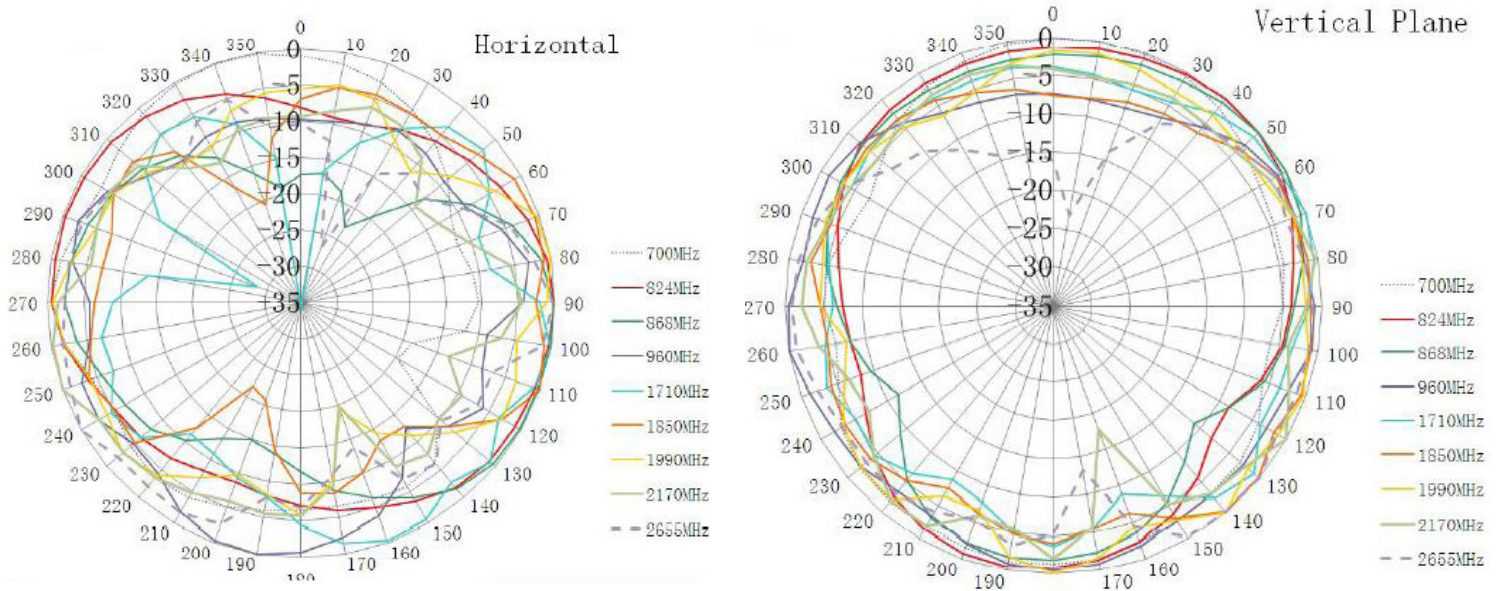

## 3D Radiation Patterns

GPS Antenna  
1575.42 MHz

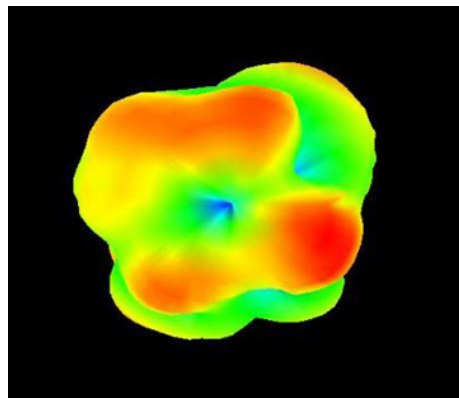

# External Combo Antenna LTE/GPS

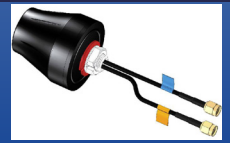

AEACBK050048-C2LG



Ø50.0 x 48.0 mm  
RoHS/RoHS II Compliant  
MSL = 1

## 3D Radiation Patterns

LTE Antenna  
698 MHz

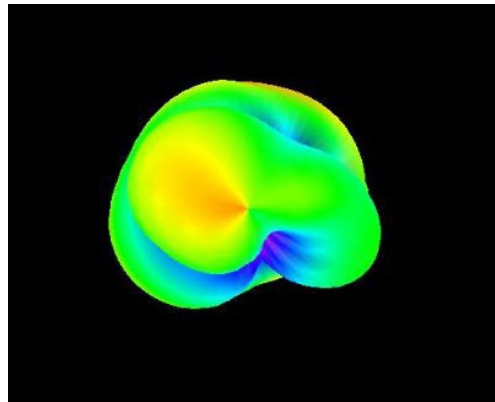

824 MHz

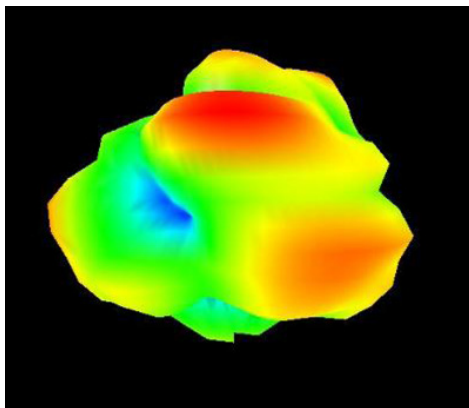

880 MHz

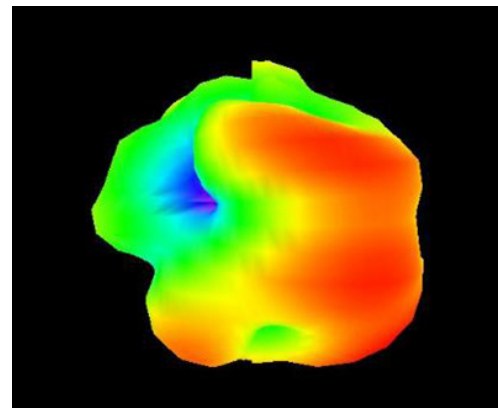

960 MHz

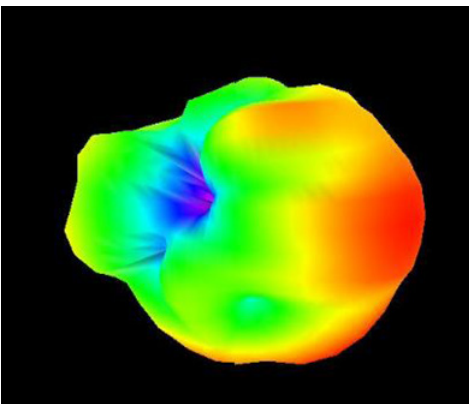

1710 MHz

