



AEAT-9922

Magnetic Encoder IC
10-Bit to 18-Bit Programmable Angular Magnetic
Encoder support On- & Off-Axis



Description

The Broadcom AEAT-9922 is an angular magnetic rotary sensor that provides accurate angular measurement over a full 360 degrees of rotation.

It is a sophisticated system that uses integrated Hall sensor elements with complex analog and digital signal processing within a single device.

A simple two-pole magnet generates the necessary magnetic field by rotating it in perpendicular. Wide magnetic field sensor configurations allow On Axis (end of shaft) or Off Axis (side of shaft) modes in application.

The Broadcom AEAT-9922 is a versatile solution capable of supporting a broad range of applications with its robust architecture to measure and deliver both absolute and incremental signals.

The absolute angle measurement provides an instant indication of the magnet's angular position with a selectable and one-time programmable resolution from 10 to 18 bits. When selected, its positioning data is then represented in its digital form to be assessed through a standard SSI (parity) and SPI (with CRC and Parity option) communication protocol. Where desired, users may also choose to receive its absolute angle position in PWM-encoded output signals (with CRC). The incremental positions are indicated on ABI and UVW signals with wide user configurable resolution from 1CPR and up to 10,000CPR of ABI signals and pole pairs from 1 to 32 pole pairs (2 to 64 poles) for UVW commutation signals.

Key Features

- 5V and 3.3V operation
- Selectable 10 bits up to 18 bits of absolute resolution
- Flexible Incremental ABI resolution ranging from 1 to 10000CPR
- Commutation angle output UVW 1pp to 32pp
- PWM output modes
- User-programmable zero position, direction, index width and index position
- Programmable hysteresis
- Absolute output over 2-wire SSI, 3-wire SSI and 4-wire SPI. Each available in different mode.
- Compact QFN-24 leads (4 mm x 4 mm) package
- RoHS compliant
- INL angle correction for high accuracy

Specifications

- Absolute 10-bits to 18-bits resolution
- Incremental output resolutions 1 to 10000 CPR
- UVW output of 1 to 32 pole pairs
- Wide operating temperature -40°C to 125°C

Applications

- Brushless DC motor and stepper motor
- Resolver and potentiometer replacement
- Industrial automation and robotics
- Industrial sewing machine and textiles equipment

NOTE This product is not specifically designed or manufactured for use in any specific device. Customers are solely responsible for determining the suitability of this product for its intended application and solely liable for all loss, damage, expense, or liability in connection with such use.

Functional Description

Figure 1 AEAT-9922 Block Diagram

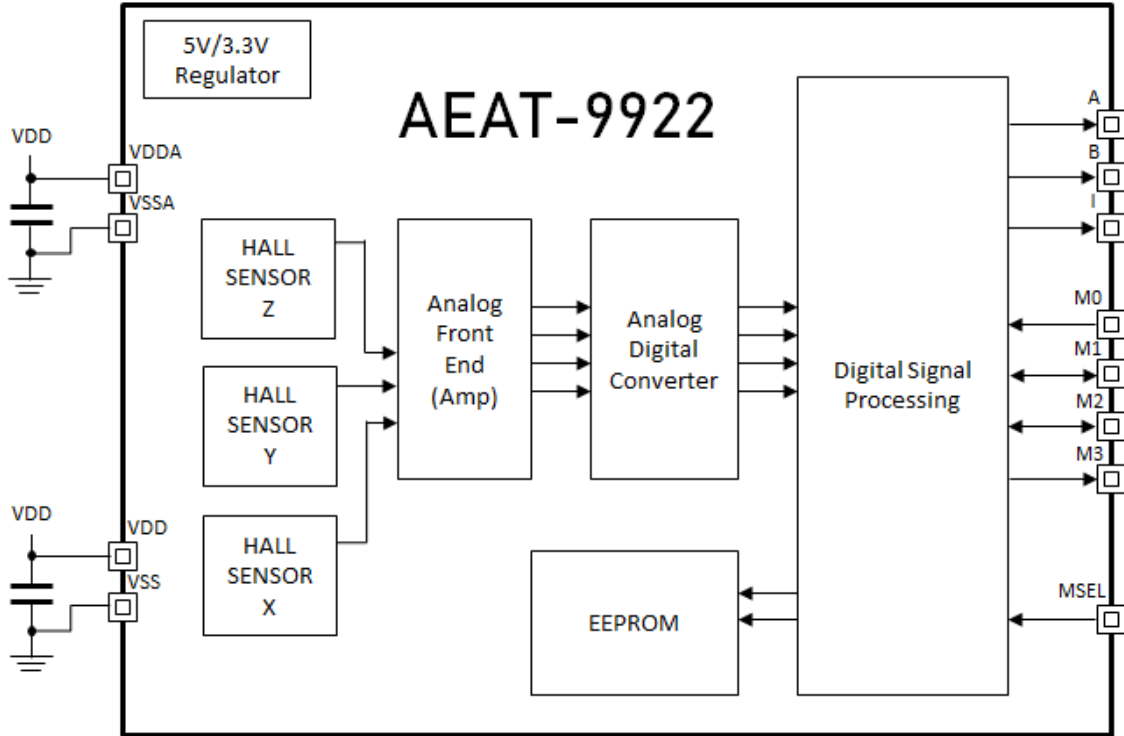

Pin Assignment

Figure 2 Pin Configurations

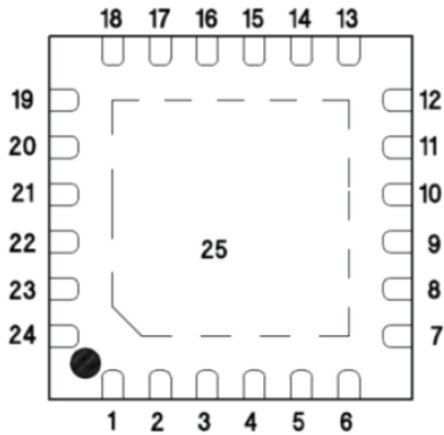

Pinout Description

Pin QFN24	Pin TSSOP16	Pin Name	I/O	Type	Functional Description
1-6	2,8	NC	-	-	No Connection
7	1	VDDA	-	Power	3.3V/5V Supply Input (Analog)
8	3	VSSA	-	Power	Supply Ground (Analog)
9	4	M0	I/O	Digital	SPI Chip select
10	5	M1	I/O	Digital	SPI Data Input / SSI NSL pin / V commutation Output (UVW)
11	6	M2	I/O	Digital	SPI/SSI Clock Input / U commutation Output (UVW)
12	7	M3	O	Digital	SPI/SSPI Data Out / W commutation Output (UVW) / PWM Output
13-18	10,16	NC	-	-	No connection
19	9	MSEL	I	Digital	Mode Selection
20	11	I	O	Digital	Incremental Index Output (ABI)
21	12	VDD	-	Power	3.3V/5V Supply Input (Digital)
22	13	VSS	-	Power	Supply Ground (Digital)
23	14	B	O	Digital	Incremental B Output (ABI)
24	15	A	O	Digital	Incremental A Output (ABI)
25	-	VSS	-	Power	Supply Ground

The AEAT-9922 is manufactured with a CMOS standard process. It is capable of accurately measuring a magnet's rotational angle when it is placed in alignment and in perpendicular to the device by using its integrated Hall sensors to detect its magnetic field. The detected magnetic signals are then taken as input signals to be properly conditioned to negate its non-idealities before inputting them into the analog amplifiers for strength amplification and filtering. After which, the amplified analog signals are then fed into the internal analog-to-digital converter (ADC) to be converted into digital signals for the final stage of digital processing.

The digital processing provides a digitized output of the absolute and incremental signals.

The used magnet should have sufficient magnetic field strength mT to generate the magnetic field for the signal generation as highlighted in the [Recommended Magnetic Input Specifications](#) section. The device provides digital information of magnetic field strength high MHi and magnetic field strength low MLo from SSI read to indicate whether the magnets are too close or too far away from our device's surface.

Users can assess the device's digitized absolute data using standard Synchronous Serial Interface (SSI) protocols. In addition, an absolute angular representation also can be selected using a pulse width modulated (PWM) signal.

The incremental outputs are available from digital outputs of their respective A, B, and I pins. This is the same for the U, V, and W pins.

Absolute Maximum Ratings

Parameter	Symbol	Min.	Max.	Unit	Notes
Storage Temperature	T _s	-40	125	°C	
DC Supply Voltage VDDA pin	VDD	-0.3	5.5	Volts	
Input Voltage Range	V _{in}	-0.3	5.5	Volts	
Electrostatic Discharge		-2.0	+2.0	kVolts	
Moisture Sensitivity Level		-	1		

CAUTION Subjecting the product to stresses beyond those listed in this section may cause permanent damage to the devices. These are stress ratings only and do not imply that the devices will function beyond these ratings. Exposure to the extremes of these conditions for extended periods may affect product reliability.

Electrical Characteristics

Recommended Operating Conditions

Parameter	Symbol	Min.	Typ.	Max.	Unit	Notes
Operating Ambient Temperature	T _A	-40	–	125	°C	
DC Supply Voltage to VDD pin 5V operation 3.3V operation	VDD	4.5 3.0	5.0 3.3	5.5 3.6	Volts	
Incremental Output Frequency	f _{MAX}	–	–	1.0	MHz	Frequency = Velocity(rpm) x CPR/60
Load Capacitance	C _L	–	–	15	pF	

Systems Parameters

Condition: Electrical characteristics over the recommended operating conditions. Typical values specified at VDD = 5.0V and 25°C, optimum placement of magnet.

Parameter	Symbol	Min.	Typ.	Max.	Unit	Notes
Current Consumption						
Supply Current Normal Operation Mode	I _{DD}	–	25		mA	5V
	I _{DD}	–	24		mA	3.3V
Digital Outputs (DO)						
High Level Output Voltage	V _{OH}	VDD - 0.5	–	–	Volts	Normal operation
Low Level Output Voltage	V _{OL}	–	–	GND + 0.4	Volts	
Power-up time Absolute Output Incremental Output PWM Output	t _{pwrUp}	–	10		ms	
Digital Inputs (DI)						
Input High Level	V _{IH}	0.7xVDD	–	–	Volts	
Input Low Level	V _{IL}	–	–	0.3xVDD	Volts	
Pull-up low level input current	I _{IL}	–	–	120	µA	
Pull-down high level input current	I _{IH}	–	–	120	µA	

Encoding Characteristics

Parameter	Symbol	Min.	Typ.	Max.	Unit	Notes
Absolute Output						
Resolution	RES	10	to	18	Bit	10, 12, 14, or 16 bits
Integral Non-Linearity ON-axis	INL _{nom}	–	+/-0.1	–	Deg	Best fit line, centered magnet. T _A = 25°C Voltage = 5V INL Angle correction
Integral Non-Linearity OFF-axis		–	+/-0.15	–		
Integral Non-Linearity ON-axis	INL _{dis}	–	+/-0.2	–	Deg	Best fit line, over displacement of magnet. T _A = 25°C Voltage = 5V
Integral Non-Linearity OFF-axis		–	+/-0.3	–		
Integral Non-Linearity ON-axis	INL _{temp}	–	+/-0.5	–	Deg	Best fit line, over displacement of magnet. T _A = –40 to +125°C Voltage = 5V
Integral Non-Linearity OFF-axis		–	+/-0.7	–		
Repeatability			1		LSB	14-bit absolute
Output Sampling Rate	f _s	–	10	–	MHz	Based on SSI protocol
Latency		–	80	–	ns	
Incremental Output (Channel ABI)						
Resolution	R _{INC}	1	–	10000	CPR	Programmable
Index Pulse Width	P _O	90	–	360	°e	Programmable options: 90, 180, 270, or 360 °e
Relative angular accuracy	%	–	10	–	%	Reference to an output period at output A and B, at 512 CPR, 5V and 3,000 RPM

PWM Output						
PWM frequency	f_{PWM}	122		976	Hz	Adjustable based on our PWM settings
Minimum pulse width	PW_{MIN}		1		μs	
Maximum pulse width	PW_{MAX}		8192		μs	

NOTE Encoding Characteristics over Recommended Operating Range unless otherwise specified.

Encoding Timing Characteristics

Parameter	Symbol	Min.	Typ.	Max.	Unit	Notes
Incremental Output (ABI & UVW)						
System reaction time	t_{delay}	-	10	-	ms	First ABI pulse detection upon power up.

Recommended Magnetic Input Specifications

Parameter	Symbol	Min.	Typ.	Max.	Unit	Notes
Diameter Disc magnet Ring magnet ID /OD	d	4 -	6 ID,15 OD,25	- -	mm mm	Recommended magnet: Cylindrical magnet or ring magnet diametrically magnetized & 1 pole pair.
Thickness Disc magnet Ring magnet	t	- 2	2.5 6	- -	mm mm	
Magnetic input filed magnitude On-axis (Disc Magnet) Off-axis (Ring Magnet)	Bpk	45 30	- -	100 150	mT mT	Required vertical/horizontal component of the magnetic field strength on the die's surface, measured along concentric circle.
Magnet displacement radius	R_m			0.25	mm	Displacement between magnet axis to the device center
Recommended magnet material and temperature drift			-0.12		%/K	NdFeB (Neodymium Iron Boron),grade N35SH

Diametrically Magnetized Magnet

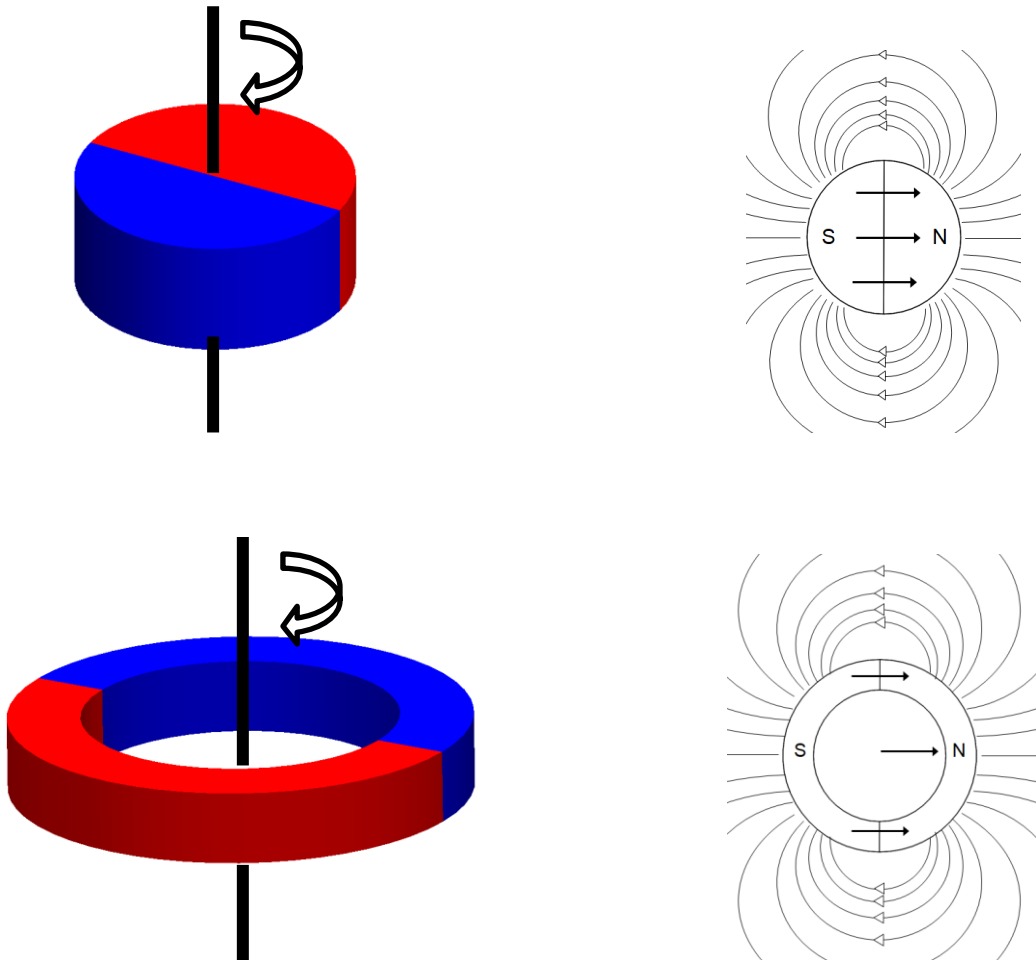

Magnet and IC Package Placement

On-axis configuration

Align the magnet's centre axis within a displacement radius of 0.25 mm from defined hall sensor centre.

Place the magnet so that it faces the sensor. The magnet must be mounted on a non-magnetic part. The Z gap varies depending on the magnetic strength on the die surface, with the recommended magnet material and dimensions.

The typical distance Z is 0.75 mm to 1.25 mm (1mm +/- 0.25mm). It is important not to put magnetic material close to the magnet because it will affect the magnetic field and increase the INL.

Figure 3 Defined Chip Sensor Center and Magnet Displacement

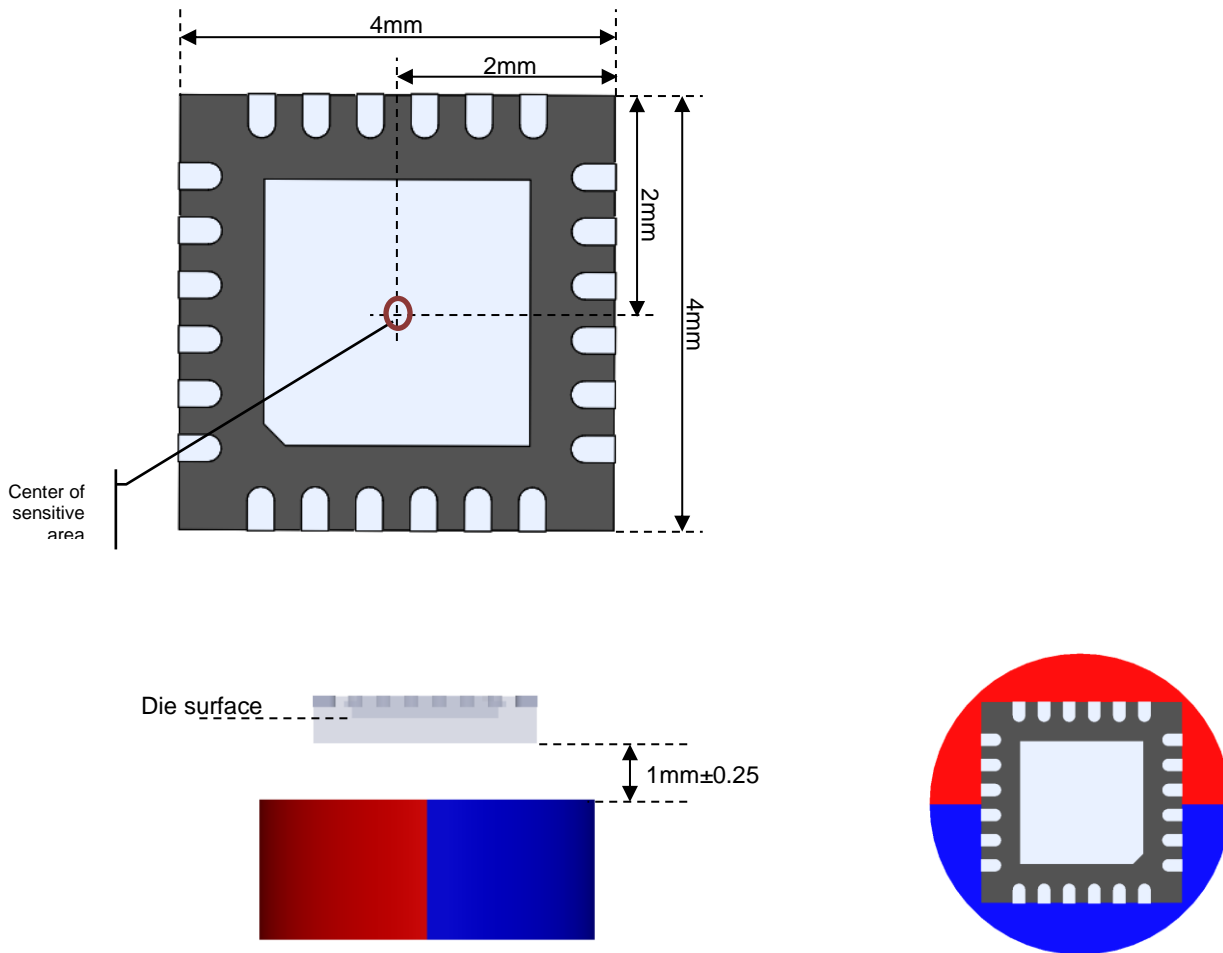

Off-axis configuration

Align the magnet's edge within a displacement of 2mm from chip edge with the centre of sensitive area orientate to it.

Place the magnet next to the sensor. The magnet must be mounted on a non-magnetic part. The air gap varies depending on the magnetic strength on the die surface, with the recommended magnet material and dimensions.

The height placement of chip in the middle of magnet thickness. It is important not to put magnetic material close to the magnet because it will affect the magnetic field and increase the INL.

Figure 4 Defined Chip Sensor Center and Magnet Displacement

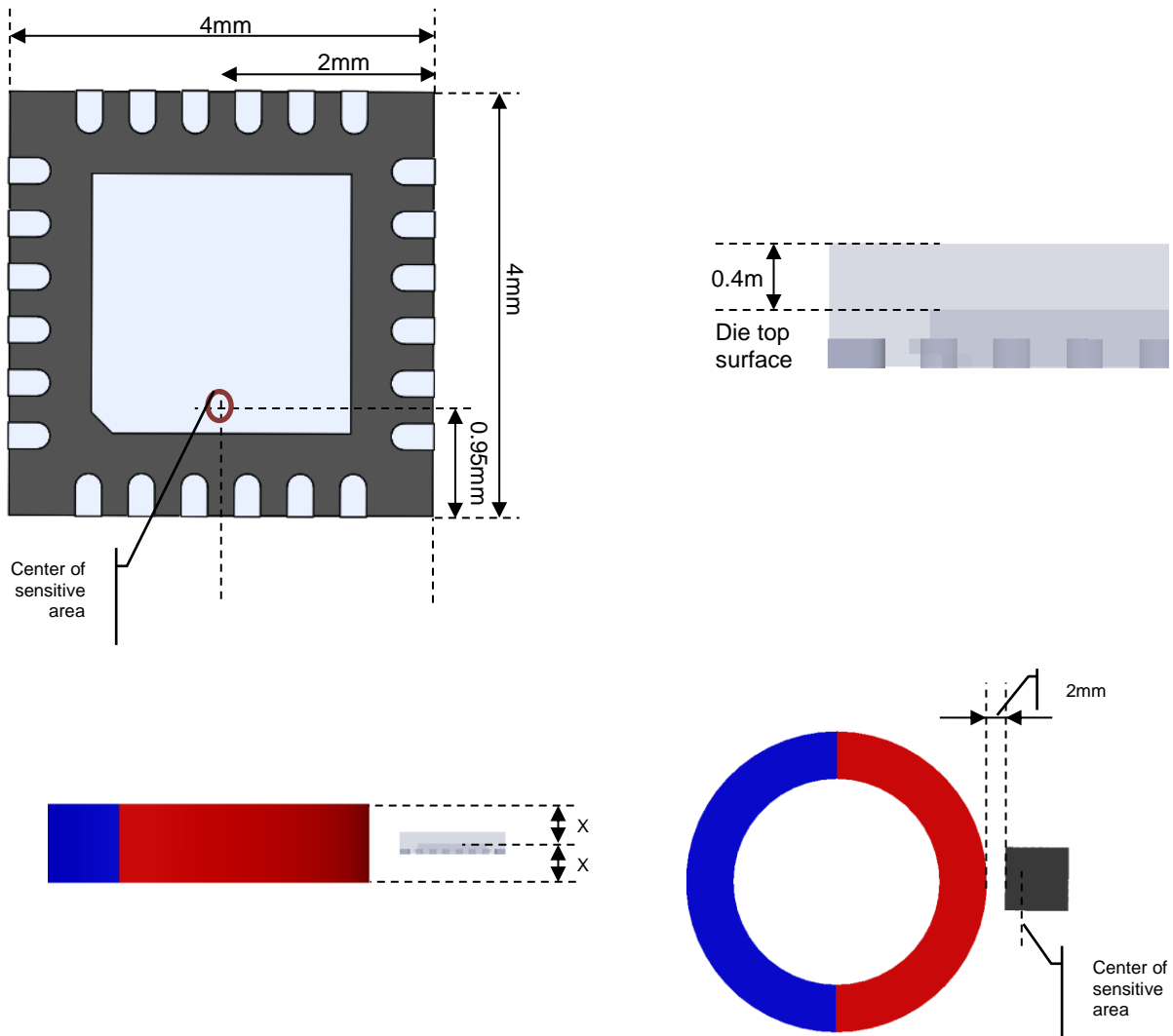

Communication Protocol

AEAT-9922 has a total of ten interfaces; one is dedicated for incremental ABI and remaining are multiplexed to I/O pin M0, M1, M2 and M3. Each output is made configurable via M0, MSEL pin and PSEL registers as shown in table below.

MATS Table

Mode Pin	SPI-3	SSI-3 (A)	SSI-3 (B)	SSI-2 (A)	SSI-2 (B)	SPI-4 (A)	SPI-4 (B)	UVW	PWM
MSEL	0	0	0	0	0	1	1	1	1
PSEL[1]	x	x	x	x	x	0	0	1	1
PSEL[0]	x	0	1	0	1	0	1	0	1
M0	0	1	1	1	1	NCS	NCS	ERR	ERR
M1	DIN	NSL	NSL	0	0	MOSI	MOSI	V	-
M2	SCK	SCL	SCL	SCL	SCL	SCK	SCK	U	-
M3	DO	DO	DO	DO	DO	MISO	MISO	W	PWM

NOTE PSEL[1], PSEL[0] is configure through memory

MSEL, M0, M1, M2, M3 is configure through IO pads

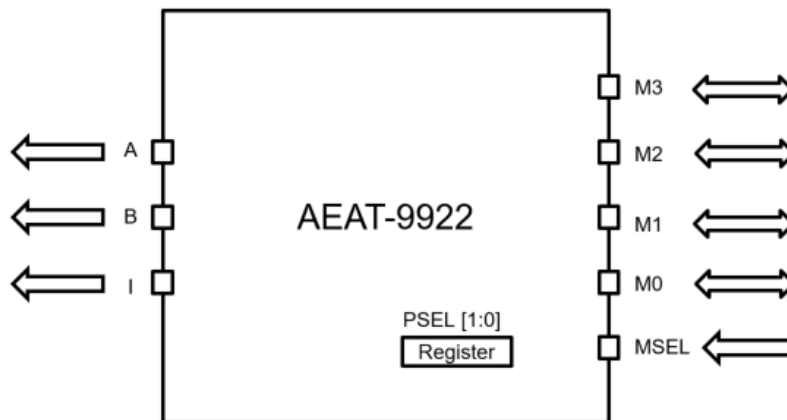

SPI Protocol

SPI protocol uses four pins from AEAT-9922. These four pins are shared between UVW, SSI, SPI protocols. MSEL (input pin) selects either protocol at a time. Assert 1 on MSEL pin to select the SPI4 protocol.

SPI4 protocols allow user to access memory read or write and position data. It uses CPOL=0, CPHA=1 for triggering.

- M0 → SPI_Chip Select (NCS) signal for SPI protocol, input to AEAT-9922
- M1 → SPI_Data Input (MOSI) signal for SPI protocol, input to AEAT-9922
- M2 → SPI_Clock Input (SCK) signal for SPI protocol, input to AEAT-9922
- M3 → SPI_Data Output (MISO) signal for SPI protocol, output from AEAT-9922

SPI4 Timing Diagram

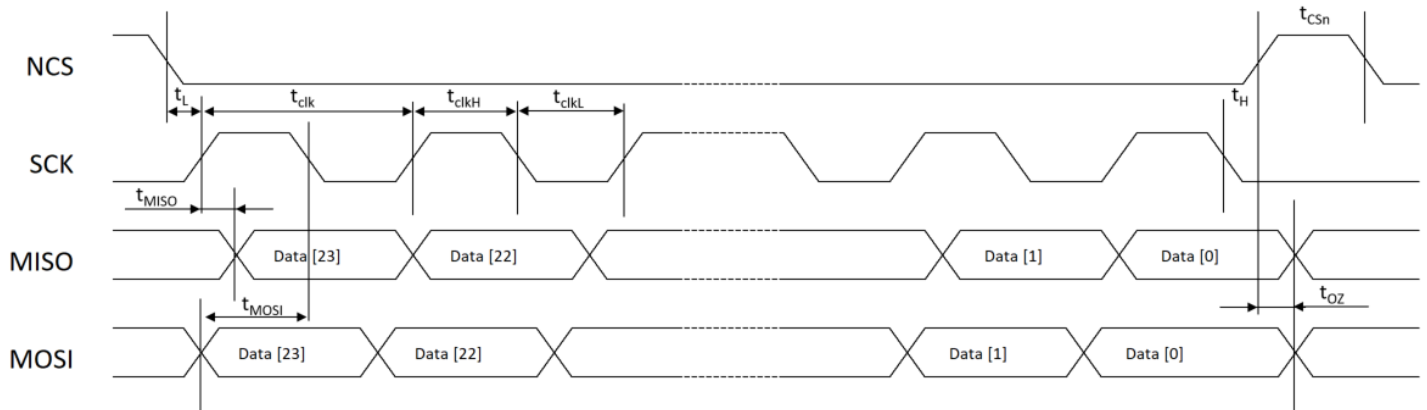

Symbol	Description	Min	Typ	Max	Unit
t_L	Time between SCn falling edge and CLK rising edge	350			ns
t_{clk}	Serial clock period	100			ns
t_{clkL}	Low period of serial clock	50			ns
t_{clkH}	High period of serial clock	50			ns
t_H	Time between last falling edge of CLK and rising edge of CSn	$t_{clk}/2$			ns
t_{CSn}	High time of CS between two transmissions	350			ns
t_{MOSI}	Data input valide to clock edge	20			ns
t_{MISO}	CLK edge to data output valid		51		ns
t_{oZ}	Time between CSn rising dege and MISO HiZ		10		ns

NOTE

- The user should read back data to confirm data is written successfully

SPI4 Command and Data Frame

SPI4 Read sequence

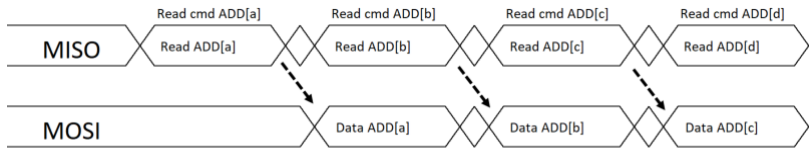

SPI4 Write sequence

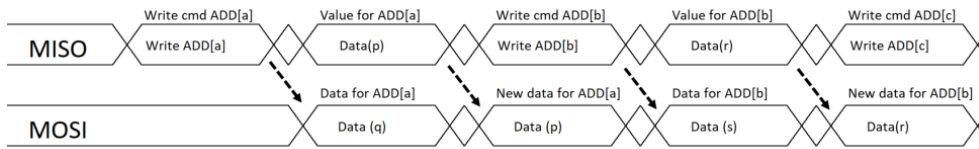

SPI-4(A) 16-bit (Parity)

By default the chip is configured to SPI4 16-bit selection, **PSEL [1] = 0, PSEL [0] = 0** in the register setting.

		Data Format																			
		19	18	17	16	15	14	13	12	11	10	9	8	7	6	5	4	3	2	1	0
Master to Slave	P	RW	0	0	0	0	0	0	0	0	0	Addr/Data[7:0]									
Slave to Master (memory)	P	EF	0	0	0	0	0	0	0	0	Data[7:0]										
Slave to Master (pos 10b)	P	EF	Pos[9:0]										0	0	0	0					
Slave to Master (pos 11b)	P	EF	Pos[10:0]										0	0	0						
Slave to Master (pos 12b)	P	EF	Pos[11:0]										0	0							
Slave to Master (pos 13b)	P	EF	Pos[12:0]										0								
Slave to Master (pos 14b)	P	EF	Pos[13:0]																		
Slave to Master (pos 15b)	P	EF	Pos[14:0]																		
Slave to Master (pos 16b)	P	EF	Pos[15:0]																		
Slave to Master (pos 17b)	P	EF	Pos[16:0]																		
Slave to Master (pos 18b)	P	EF	Pos[17:0]																		

P: Parity

EF: Error Flag

RW: Read = 1, Write = 0

SPI4-(B) 24-bit (CRC)

To configure the chip to SPI4 24-bit selection, set **PSEL [1] = 0, PSEL [0] = 1** in the register setting.

		Data Format																											
		27	26	25	24	23	22	21	20	19	18	17	16	15	14	13	12	11	10	9	8	7	6	5	4	3	2	1	0
Master to Slave		0	RW	0	0	0	0	0	0	0	Addr/Data[7:0]							CRC[7:0]											
Slave to Master (memory)		W	E	0	0	0	0	0	0	Data[7:0]							CRC[7:0]												
Slave to Master (pos 10b)		W	E	Pos[9:0]									0	0	0	0	CRC[7:0]												
Slave to Master (pos 11b)		W	E	Pos[10:0]									0	0	0	CRC[7:0]													
Slave to Master (pos 12b)		W	E	Pos[11:0]									0	0	CRC[7:0]														
Slave to Master (pos 13b)		W	E	Pos[12:0]									0	CRC[7:0]															
Slave to Master (pos 14b)		W	E	Pos[13:0]									CRC[7:0]																
Slave to Master (pos 15b)			W	E	Pos[14:0]									CRC[7:0]															
Slave to Master (pos 16b)			W	E	Pos[15:0]									CRC[7:0]															
Slave to Master (pos 17b)			W	E	Pos[16:0]									CRC[7:0]															
Slave to Master (pos 18b)		W	E	Pos[17:0]									CRC[7:0]																

W: Warning

E: Error

RW: Read = 1, Write = 0

Position Read

Absolute position data can be obtained by sending read command to address **0x3F**.

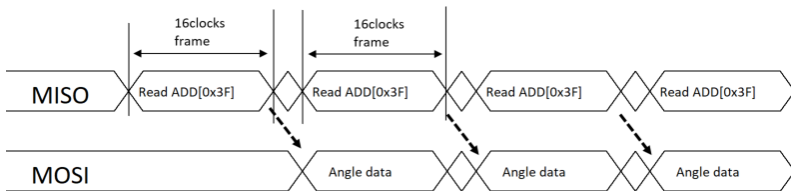

In the event of higher single turn resolution (15-bit and above), the command and data frame size is adjusted accordingly.

Example: 18bit + 2bit (parity and error)

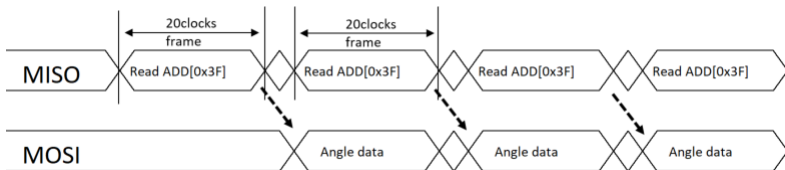

Warning and Error bit

Error bit is trigger if either Magnet High (MHI), Magnet Low (MLO), Memory Error (MEM_Err) or communication error.

Details of error bit is available in register address below:

Address	bit							
	7	6	5	4	3	2	1	0
0x21	RDY	MHI	MLO	MEM_Err				

- **Magnet High (MHI) Error:** This indicates that the magnet strength detected by the chip is too strong. When this is flagged high consistently, change the weaker magnet or increase the distance between the chip and the magnet. The value for this alarm is represented as 1.
- **Magnet Low (MLO) Error:** This indicates that the magnet strength detected by the chip is too weak. When this is flagged high consistently, change the stronger magnet or decrease the distance between the chip and the magnet. The value for this alarm is represented as 1.
- **Ready:** The chip is ready, and the ready value is 1.

SPI3

SPI3 protocols only allow access to memory read write. Assert 0 on **MSEL** and **M0** pin to configure it.

- M0 → Set to low, input to AEAT-9922
- M1 → SPI_Data Input (DIN) signal for SPI protocol, input to AEAT-9922
- M2 → SPI_Clock Input (SCK) signal for SPI protocol, input to AEAT-9922
- M3 → SPI_Data Output (DO) signal for SPI protocol, output from AEAT-9922

SPI3 Timing Diagram

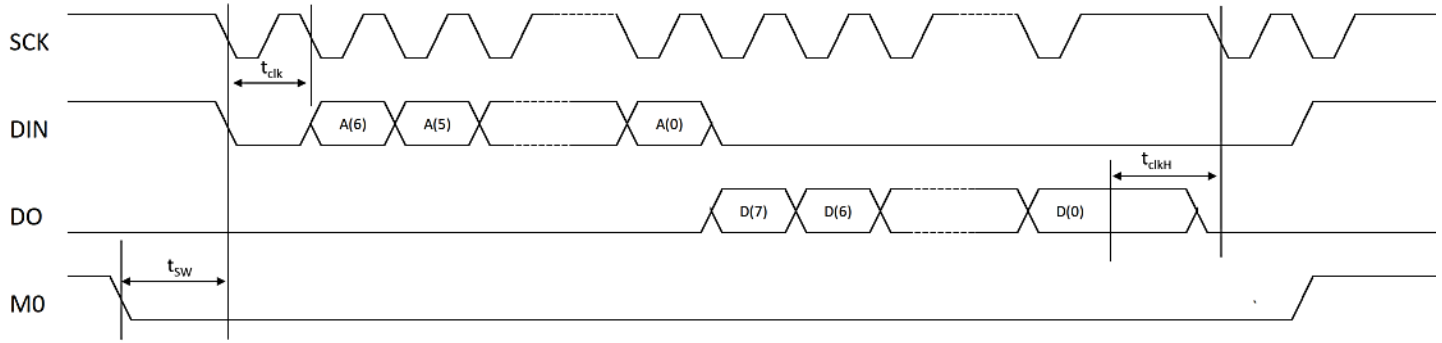

Symbol	Description	Min	Typ	Max	Unit
t_{sw}	Time between SCn falling edge and CLK rising edge	1	-	-	us
t_{clk}	Serial clock period	-	-	100	ns
t_{clkH}	CLK high time after end of last clock period	300	-	-	ns

NOTE

- The user should read back data to confirm data is written successfully

SPI3 Read

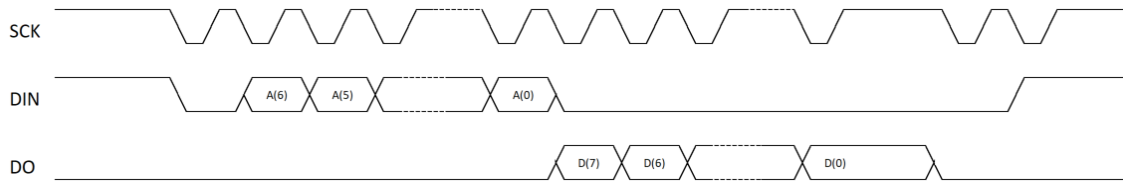

SPI3 Write

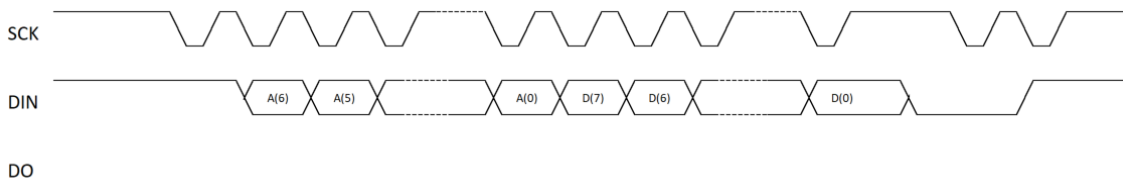

Serial Synchronous Interface 3-wire (SSI3)

SSI3 protocol uses three pins from AEAT-9922. These three pins are shared between UVW, SSI, SPI protocols. MSEL (input pin) selects either protocol at a time. Assert 0 on **MSEL** pin and 1 on **M0** pin to select the SSI protocol.

- M1 → SSI_NSL Input (NSL) signal for SSI protocol, input to from AEAT-9922
- M2 → SSI_Clock Input (CLK) signal for SSI protocol, input to AEAT-9922
- M3 → SSI_Data Output (DO) signal for SSI protocol, output from AEAT-9922

It is available in 2 options per PSEL register setting:

Figure 6 SSI Protocol Timing Diagram

Default : Data Output with 3 wire SSI to 10Mhz clock rates

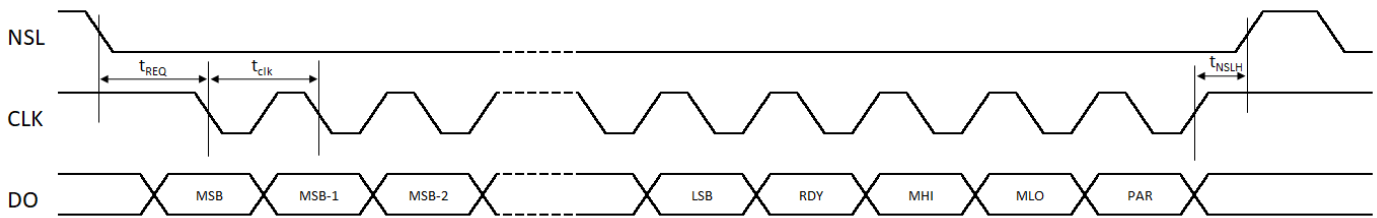

Symbol	Description	Min	Typ	Max	Unit
t_{clk}	SSI_SPI_SEL switch time	1	-	-	Us
t_{REQ}	SCL high time between NLS falling edge and first SCL falling edge	300	-	-	ns
t_{NSLH}	NSL high time between 2 successive SSI reads	200	-	-	ns

SSI-3(A)

DO pin is held at high state once NSL pin is high

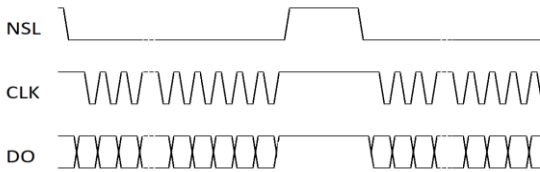

SSI-3(B)

DO pin is tristate (high impedance) state once NSL pin is high

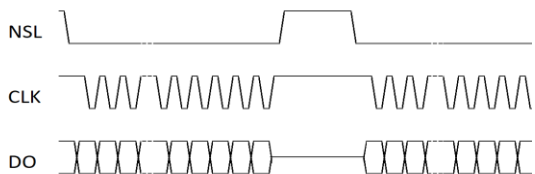

Serial Synchronous Interface 2-wire (SSI2)

SSI2 protocol uses two pins from AEAT-9922. These two pins are shared between UVW, SSI, SPI protocols. MSEL (input pin) selects either protocol at a time. Assert 0 on **MSEL & M1** pin and 1 on **M0** pin upon power up.

- M2 → SSI_Clock Input (CLK) signal for SSI protocol, input to AEAT-9922
- M3 → SSI_Data Output (DO) signal for SSI protocol, output from AEAT-9922

It is available in 2 options per PSEL register setting:

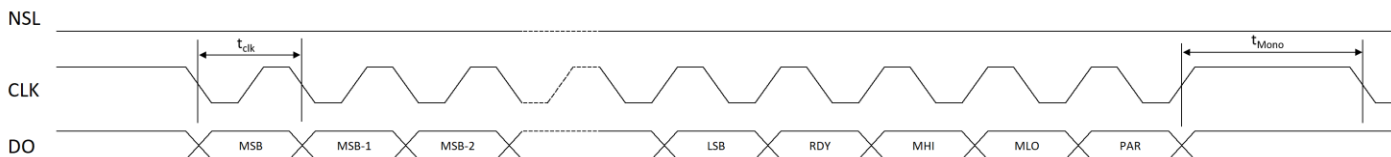

Symbol	Description	Min	Typ	Max	Unit
tClk	NSL low time after rising edge of last clock period for an SSI read	250	-	tM/2	ns
tM	NSL high time between 2 successive SSI reads	-	16.5	18.0	us

SSI-2(A)

Output single data position and remains low after LSB until the next monoflops (tM) expires.

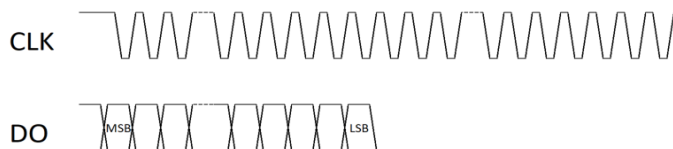

SSI-2(B)

The same position data can be continuously output by sending clock train and data is separated by a single low pulse. Data will be refresh on the next monoflop (tM) expires.

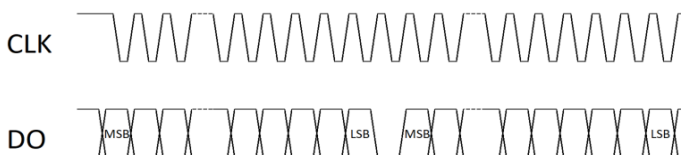

SSI3 READ Data Format

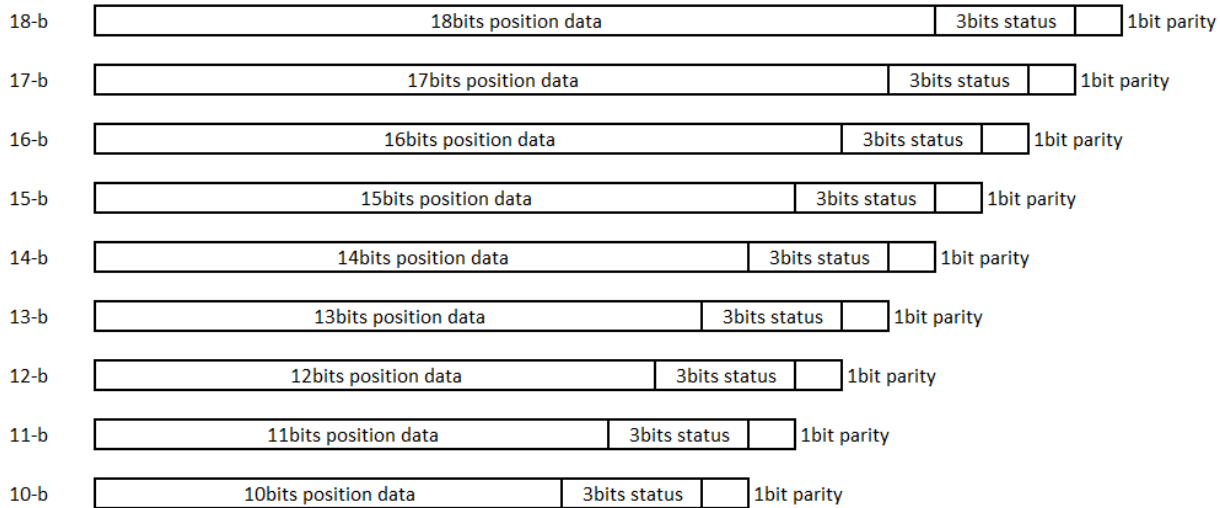

NOTE

- 3-b status: {Ready, MHI, MLO}
- **Magnet High (MHI) Error:** This indicates that the magnet strength detected by the chip is too strong. When this is flagged high consistently, change the weaker magnet or increase the distance between the chip and the magnet. The value for this alarm is represented as 1.
- **Magnet Low (MLO) Error:** This indicates that the magnet strength detected by the chip is too weak. When this is flagged high consistently, change the stronger magnet or decrease the distance between the chip and the magnet. The value for this alarm is represented as 1.
- **Ready:** The chip is ready, and the ready value is 1. 1-b parity is even parity.

PWM

PWM protocol uses one output pin (W_PWM) from AEAT-9922. Note that W_PWM pin is shared between UVW and PWM protocols. The PWM signals are configurable to have period of 1025, 2049, 4097, 8193 or 16385 μs . During power-up, the PWM signal is 0 before chip ready.

PWM Signals (Period = 1025/2049/4097/8193/16385 μs)

- PWM period: 1025, 2049, 4097, 8193, 16385 μs

PWM Period: 1025us

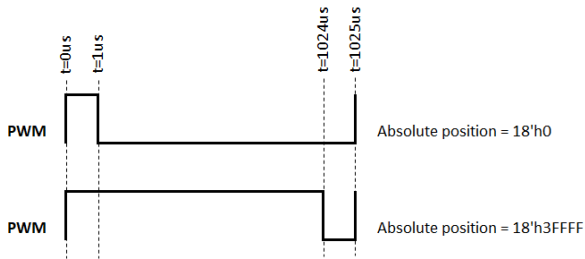

PWM Period: 2049us

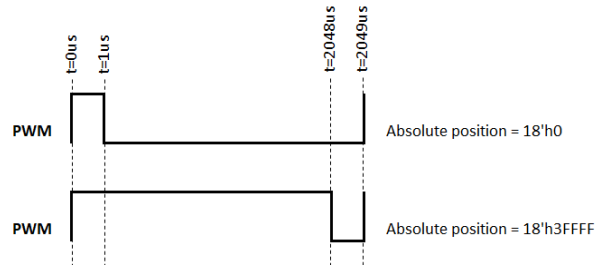

PWM Period: 4097us

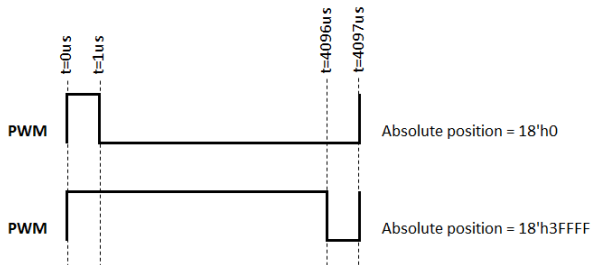

PWM Period: 8193us

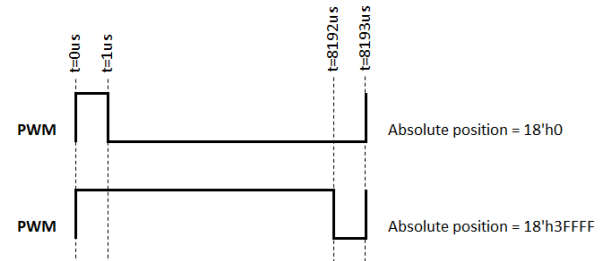

PWM Period: 16385us

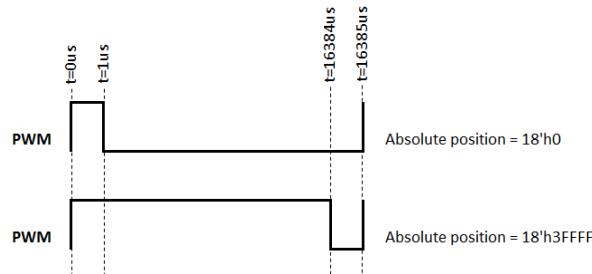

PWM protocols is also available in with Init, Error_n, and Exit along with Data information.

PWM Signals (Period = 1047/2071/4119/8215/16407 μs)

PWM Period: 4119us

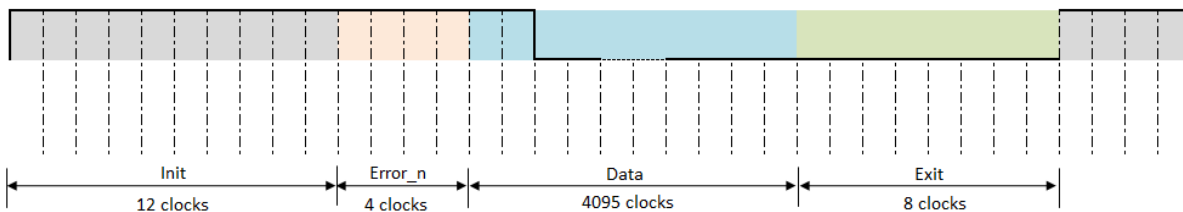

Incremental Output Format

The AEAT-9922 provides ABI and UVW signals to indicate incremental position of the motor.

ABI

The ABI incremental interface is available to provide position data and direction data from the three output pins (A, B, and I).

The index signal marks the absolute angular position and typically occurs once per revolution. The ABI signal is configurable using the memory map registers. It supports the following configuration:

- Programmable CPR: 1 to 10000CPR
- Programmable I-width: 90, 180, 270, or 360 electrical degrees (edeg)

Figure 7 ABI Signal (4096 CPR, with Different I-Width Settings), Assuming User Sets Hysteresis at 0.02 Mechanical Degree

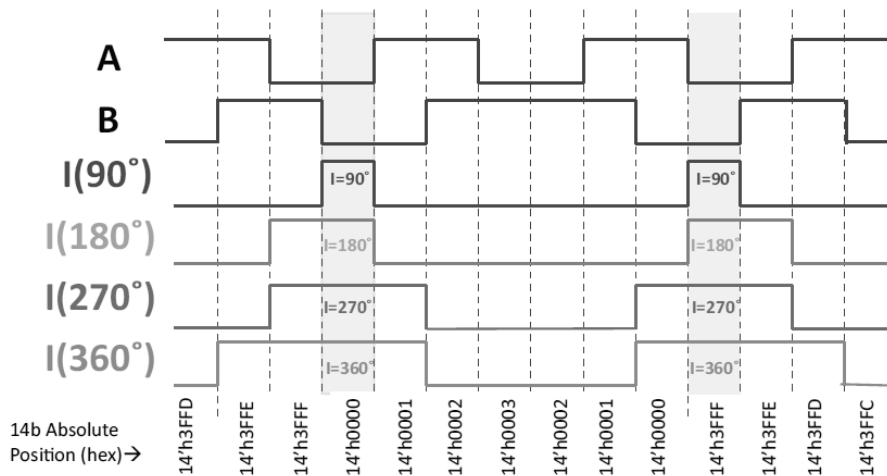

The Index position is configurable among the incremental state. Index signal raise high once per turn at absolute zero position.

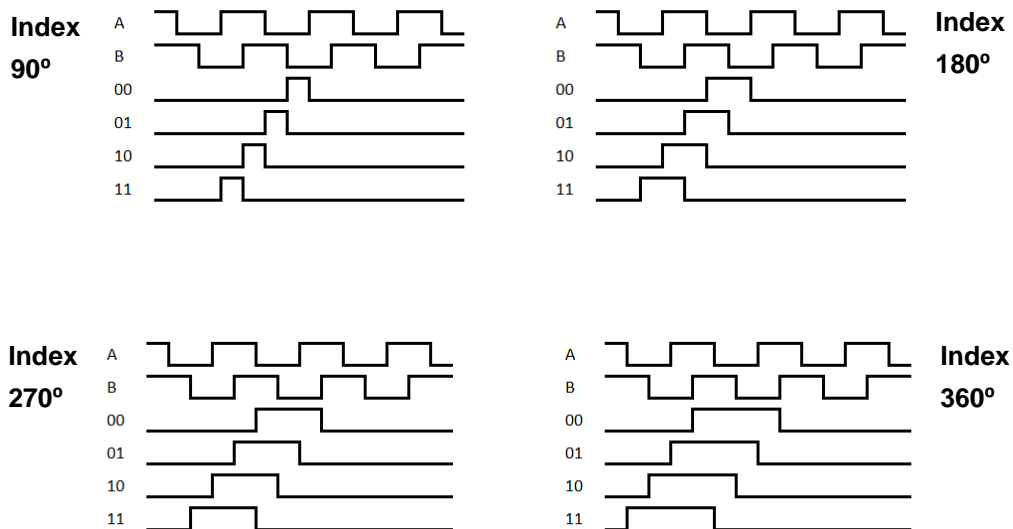

UVW

Three-channel integrated commutation output (U, V, W) emulates Hall sensor feedback and is available using three output pins. Note that W_PWM pin is shared between the UVW and PWM protocols.

AEAT-9922 can configure pole pairs from 1 to 8 equivalents to 2 to 16 poles.

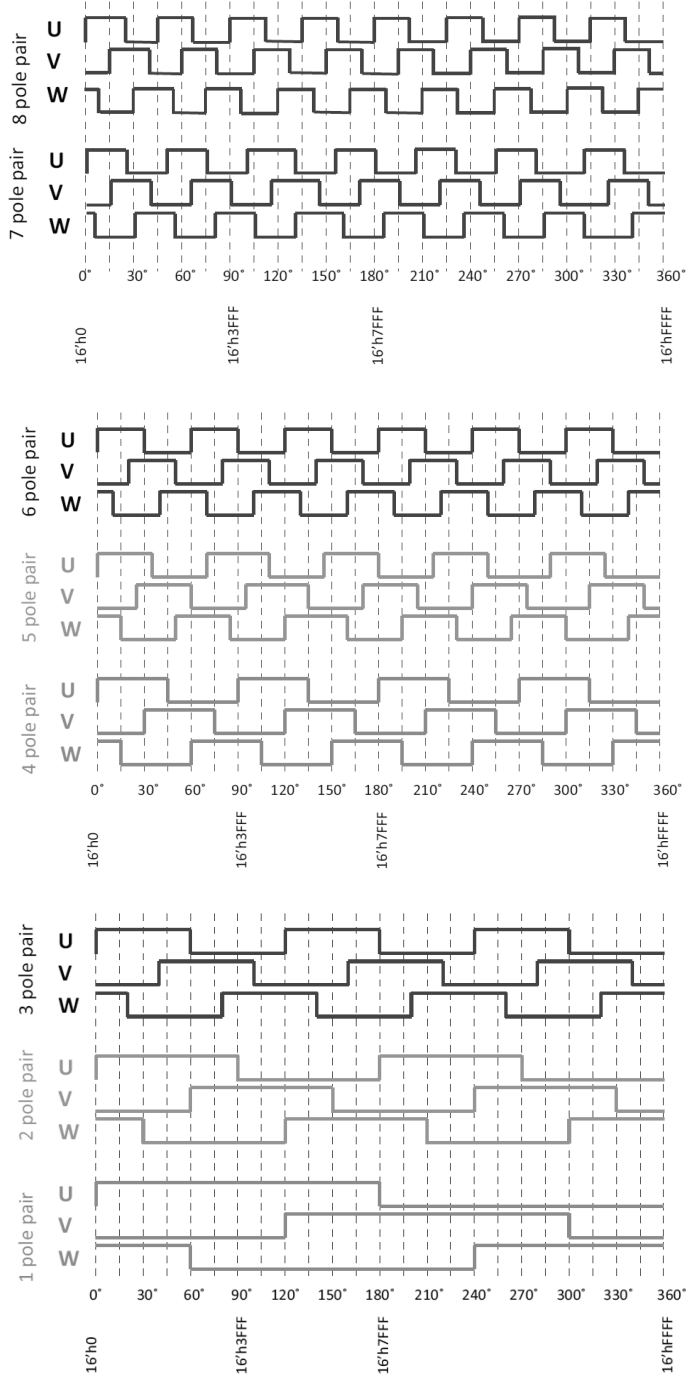

Note that signal U from UVW protocol is tagged to signal I from the ABI protocol as shown in the following figure.

Figure 8 U-to-I Tagging

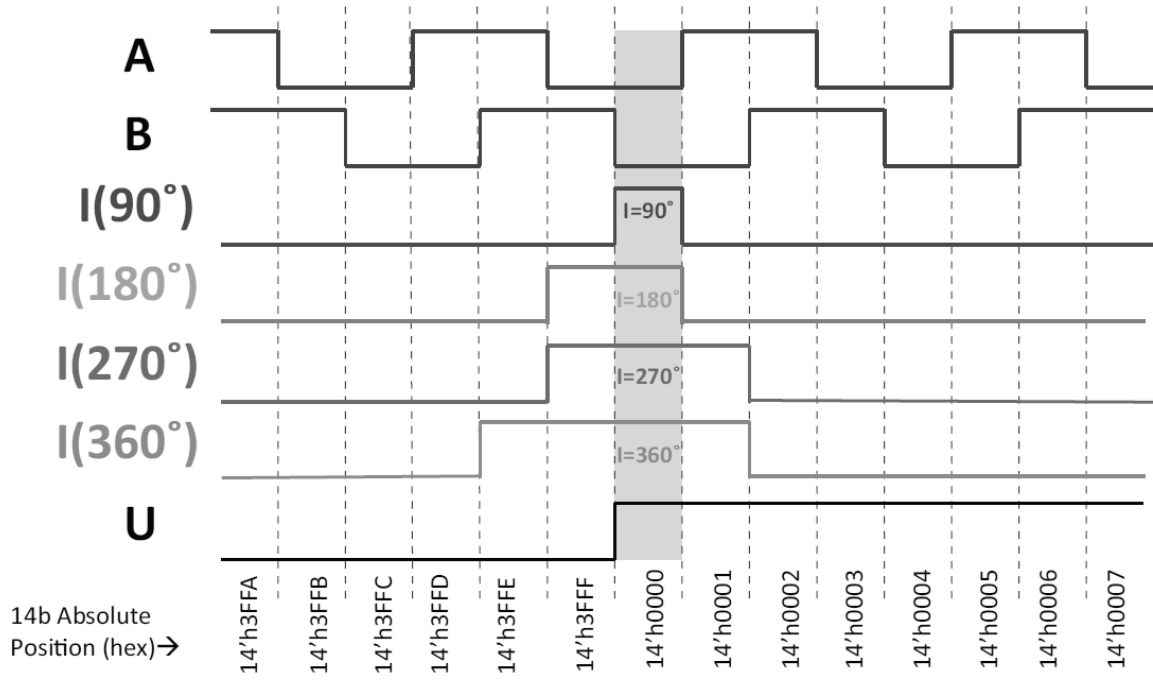

Package Drawings (in mm)

Figure 9 AEAT-9922, 24 QFN Dimensions

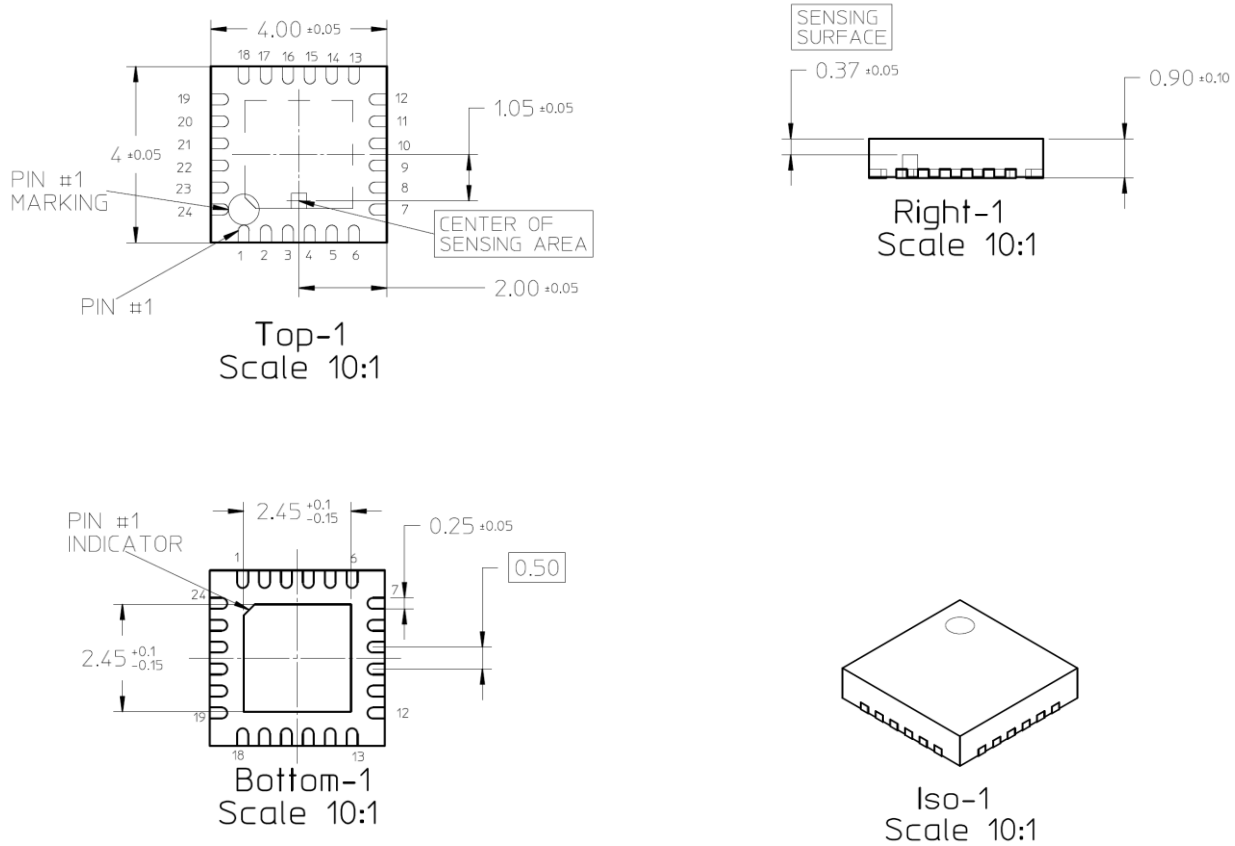

Product Ordering Information

Ordering Part Number	Product Description	Package	Delivery Form
AEAT-9922-100	18Bits Magnetic Encoder On-Off Axis Tape Reel 1000	QFN 24 leads, 4 mm x 4 mm	Tape & Reel
AEAT-9922-102	18Bits Magnetic Encoder On-Off Axis Tape Reel 100	QFN 24 leads, 4 mm x 4 mm	Tape & Reel
AEAT-9922-Q24	18Bits Magnetic Encoder On-Off Axis	QFN 24 leads, 4 mm x 4 mm	Tube