

AEDR-872x

3-Channel Reflective Incremental Encoder (Analog Output)

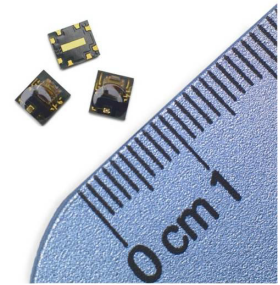

Description

The Broadcom[®] AEDR-872x encoder is a three-channel optical encoder with two channels differential analog and a third digital index output. The encoder is designed to operate over -40°C to 85°C temperature range and so is suitable for both commercial and industrial end applications.

The encoder houses an LED light source and photo-detecting circuitry in a single package. The small size of 3.95 mm (L) \times 3.4 mm (W) \times 0.9562 mm (H) allows it to be used even in a wide range of miniature commercial applications in which size and space is a primary concern.

The AEDR-872x encoder, with two channels differential analog outputs (Sin, /Sin, Cos, /Cos) can be interfaced directly with most of the external interpolators available. As such, the encoder provides great design-in flexibility and easy integration into existing systems.

Features

- Analog Output option: Two-channel differential analog output and with a digital index output
- Surface mount leadless package: 3.95 mm (L) \times 3.4 mm (W) \times 0.9562 mm (H)
- Operating voltage of 5.0 V supply
- Built-in LED current regulation, and so no external biasing resistor is needed
- -40°C to 85°C absolute operating temperature
- High encoding resolution: 318 (lines/inch, LPI)

Applications

Ideal for high volume applications:

- Closed-loop stepper motors
- Miniature motors
- Printers and copiers
- Card readers
- Scanners
- Projectors
- Portable medical equipment
- Optometric equipment
- Consumer and industrial product applications

Output Waveform

Analog Option

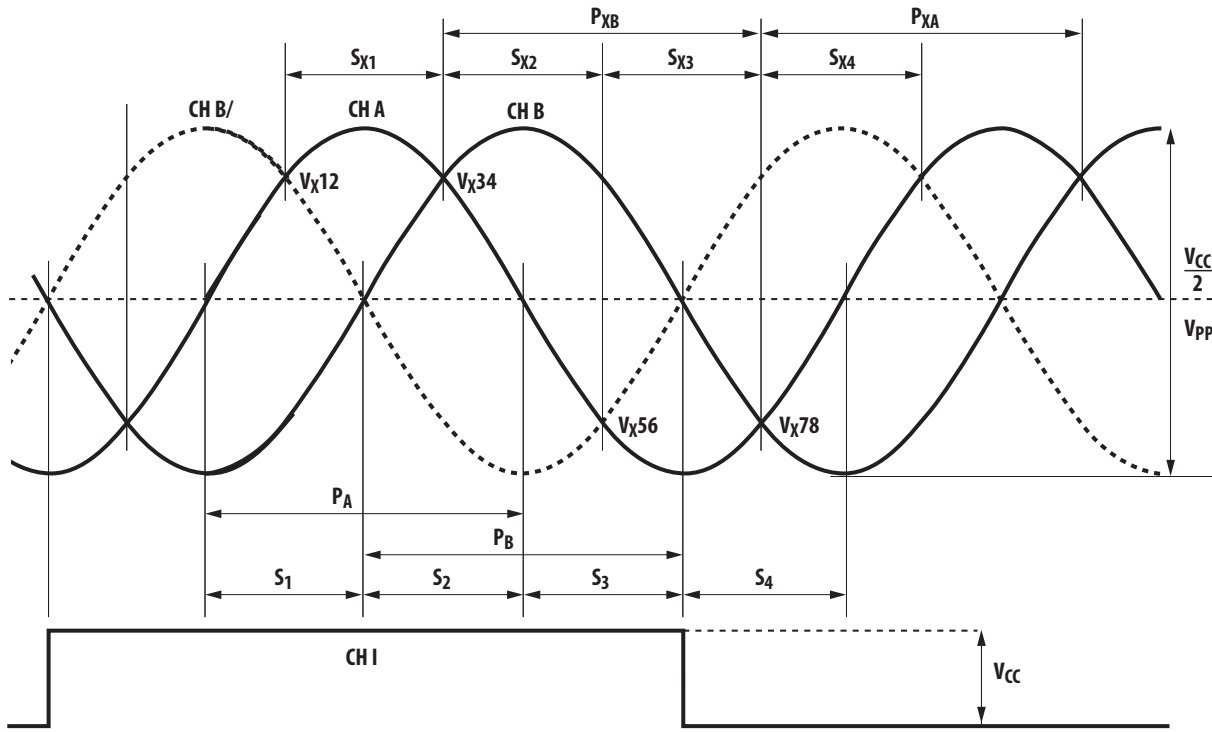

Codewheel rotation movement (anti-clockwise)

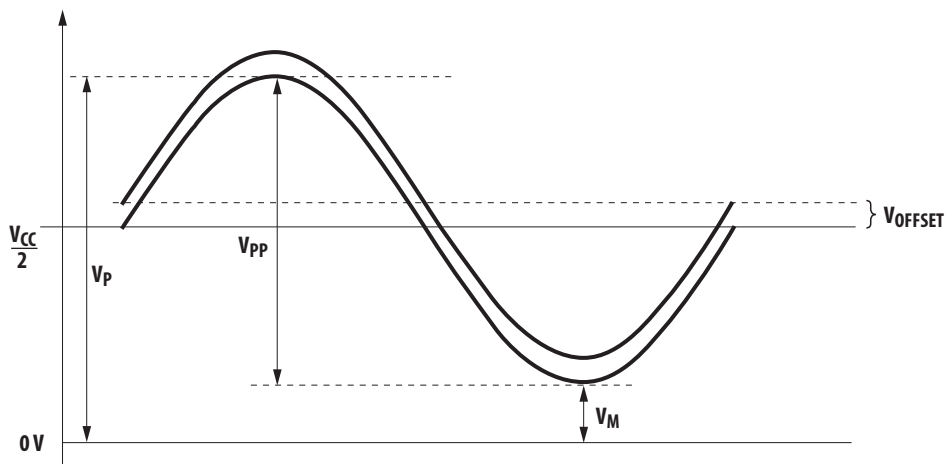

Test Parameter Definitions

| Parameter | Symbol | Description |
|-----------------------------|--------------------------------------|--|
| Analog Peak-to-Peak | V_{PP} | The peak-to-peak signal magnitude in V of the analog signal |
| Analog Offset | V_{OFFSET} | The offset in mV from the midpoint of the analog peak-to-peak signal to the zero voltage point |
| Analog Peak/Valley Voltage | $V_{PA}, V_{PB}, V_{MA}, V_{MB}$ | The value in V of the peak or valley of the analog signal (that is, one-sided reading) |
| Analog Peak-to-Peak Voltage | V_{PPA}, V_{PPB} | The absolute difference between VP and VM of channel A or B |
| Analog Crosspoint Voltage | $V_{X12}, V_{X34}, V_{X56}, V_{X78}$ | The intersections in V of channel A analog waveform with that of either channel B or its component |
| Analog Offset Voltage | $V_{OFFSETA}, OFFSETB$ | The offset in mV from the midpoint of the analog peak-to-peak signal to 2.5 V |

Absolute Maximum Ratings

| Parameter | Value |
|------------------------------|---------------|
| Storage Temperature, T_S | -40°C to 85°C |
| Operating Temperature, T_A | -40°C to 85°C |
| Supply Voltage, V_{CC} | 7V |

NOTE:

1. Exposure to extreme light intensity (such as from flashbulbs or spotlights) may cause permanent damage to the device.
2. Proper operation of the encoder cannot be guaranteed if the maximum ratings are exceeded.

ATTENTION: To avoid damage or degradation induced by ESD, take normal static precautions when handling the encoder.

Recommended Operating Conditions

| Parameter | Symbol | Min. | Typ. | Max. | Units | Notes |
|-------------------------|----------|------|------|-------|-------|--------------------------------|
| Operating Temperature | T_A | -40 | 25 | 85 | °C | |
| Supply Voltage | V_{CC} | 4.5 | 5 | 5.5 | V | Ripple < 100 mV _{p-p} |
| Current | I_{CC} | — | 27 | 60 | mA | |
| Max. Output Frequency | F | — | — | 120 | kHz | |
| Radial Misalignment | E_R | — | — | ± 0.2 | mm | |
| Tangential Misalignment | E_T | — | — | ± 0.2 | mm | |
| Codewheel Gap | G | 0.5 | 0.75 | 1.0 | mm | |

Recommended Codewheel Characteristics

| Parameter | Symbol | Min. | Max. | Unit | Notes |
|----------------------|-------------------|-----------------|------------|----------------|------------------------------|
| Window/Bar Ratio | W_W/W_B | 0.9 | 1.1 | | |
| Window/Bar Length | L_W | 1.80 (0.071) | — | mm (inches) | |
| Specular Reflectance | Rf | 60 | — | | Reflective area ^a |
| | | — | 10 | | Non-reflective area |
| Line Density | LPmm ^b | 12.52 | lines/mm | | |
| | LPI | 318 | lines/inch | | |

a. Measurements from TMA μ Scan meter

b. LPmm = CPR/[2 π .R_{op}(mm)].

Encoder Pinouts

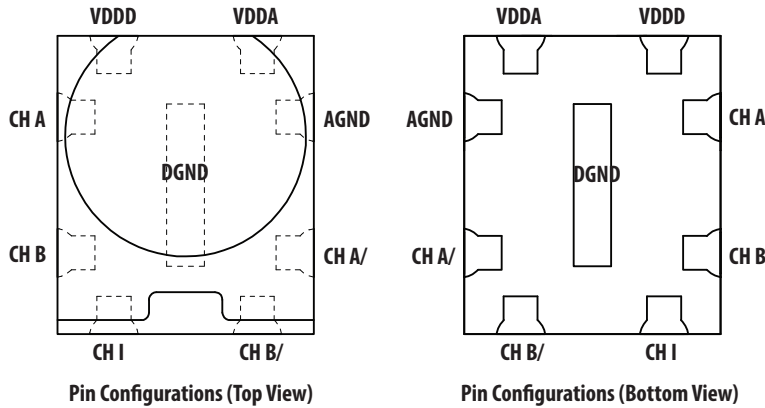

Recommended Setup For the Power Supply Pins

Connect both V_{DDD} , V_{DDA} and their corresponding grounds (AGND and DGND) appropriately as follows. It is recommended that you use 22 μF and 0.1 μF for bypass capacitor on V_{DDD} and V_{DDA} and place them in parallel as close as possible to the power and the ground pins. Do not run CH I in parallel and close to the trace of analog signals. Always keep the trace routing and cable to the minimum length.

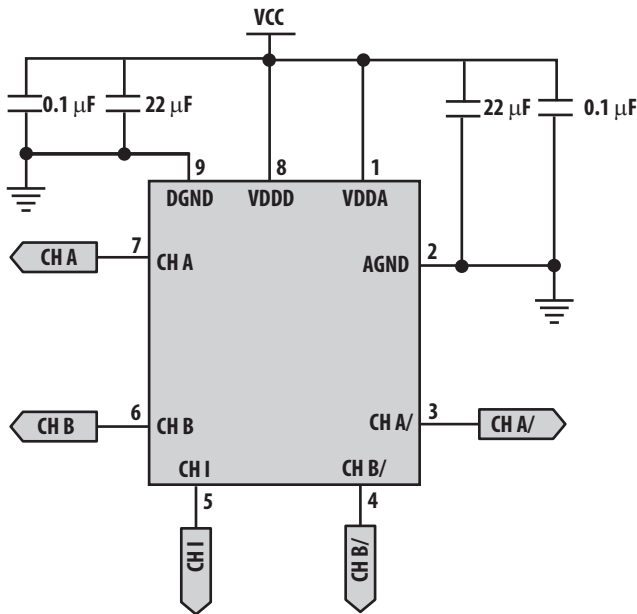

NOTE: Pin 9 is the center pad of the package.

Encoding Characteristics

| Parameter | Symbol | Min. | Typ. | Max. | Unit |
|--|----------------------------|---------------|--------------|---------------|------|
| Peak-to-Peak Voltage (Average) | V_{PPA}, V_{PPB} | 0.9 | 1 | 1.1 | V |
| Analog Offset Voltage | $V_{OFFSETA}, V_{OFFSETB}$ | $0.45 V_{CC}$ | $0.5 V_{CC}$ | $0.55 V_{CC}$ | V |
| Voltage Reference (Midpoint of signal Vpp) | V_{REF} | — | $V_{CC}/2$ | — | V |

| Parameter | Symbol | Typ. | Unit |
|-----------------------------|--------------|----------|------|
| Index Pulse Width (Ungated) | I | 430 | °e |
| State Width Error | ΔS | ± 8 | °e |
| Pulse Width Error | ΔP | ± 12 | °e |
| State X Width Error | ΔS_x | ± 5 | °e |
| Pulse X Width Error | ΔP_x | ± 5 | °e |

NOTE:

1. Typical values represent the average values of encoder performance in our factory-based setup conditions.
2. The optimal performance of the encoder depends on the motor/system setup condition of the individual customer.

Codewheel Design Guideline

The index bar (I-) track is opaque and the width is $3 \times W_B^\circ$. The Index (I) track is reflective and the width is $3 \times W_W^\circ$. The dimension L_W should be at least 1.8 mm. (Note: If L_W shorter than 1.8 mm is required, consult the factory). There are six pairs of incremental track (1 pair= $1 W_B^\circ$ and $1 W_W^\circ$) between opaque and reflective index tracks.

Figure 1: Codewheel Design Example

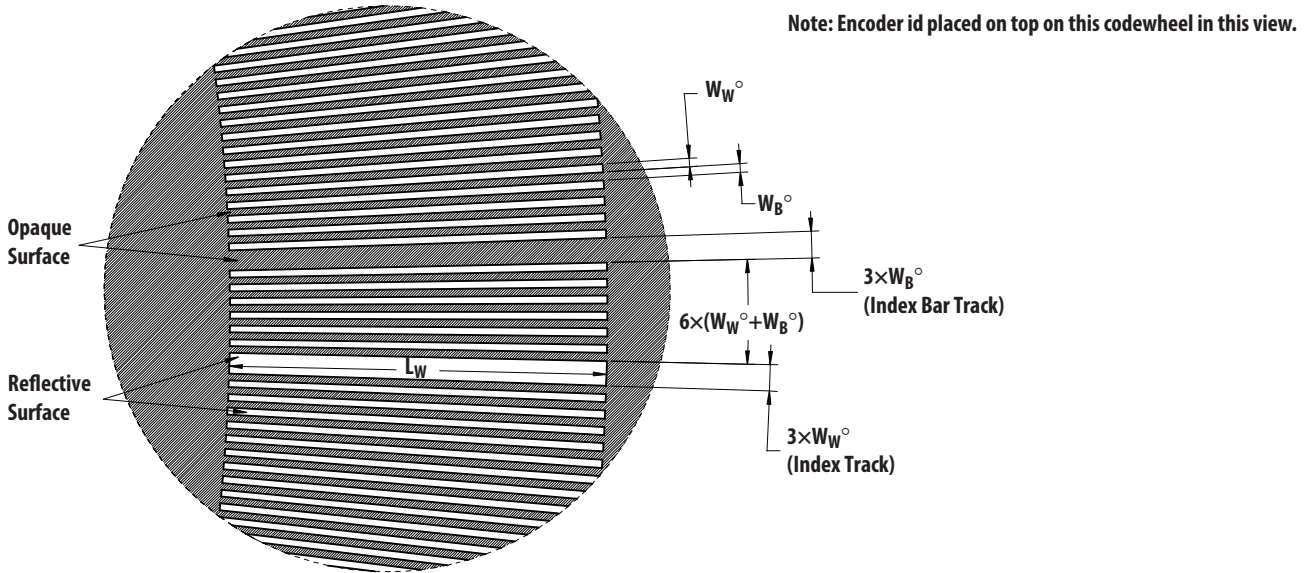

The following demonstrates a codewheel design for R_{op} of 11 mm @ 865 CPR for a 2-channel and a 3-channel encoder.

Figure 2: Codewheel Pattern for a 2-Channel Encoder

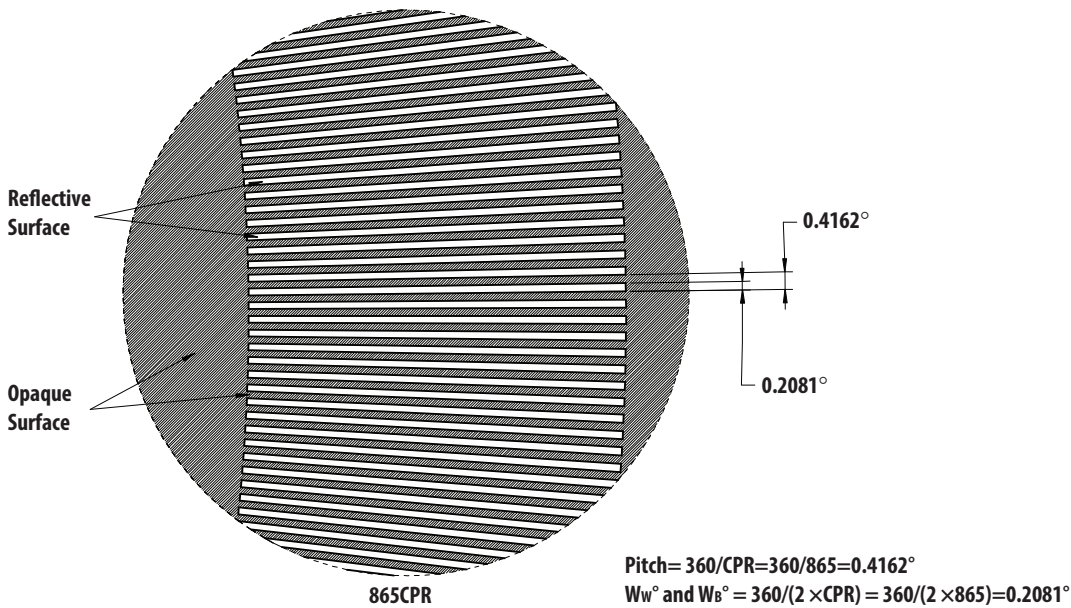
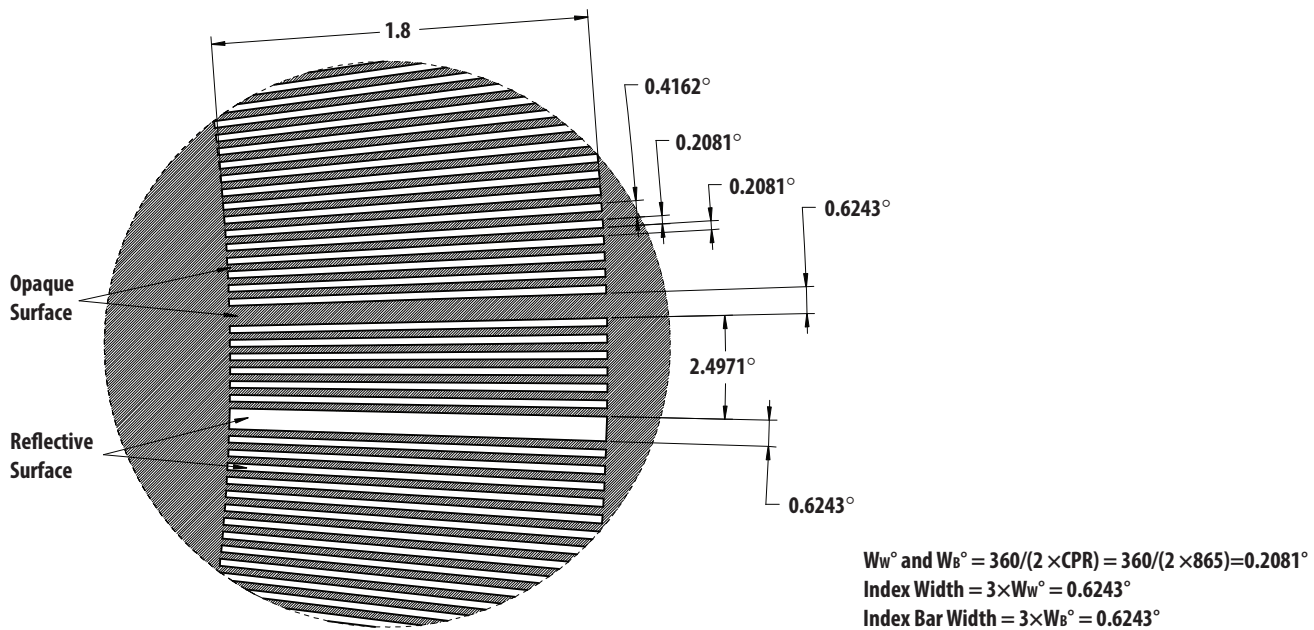
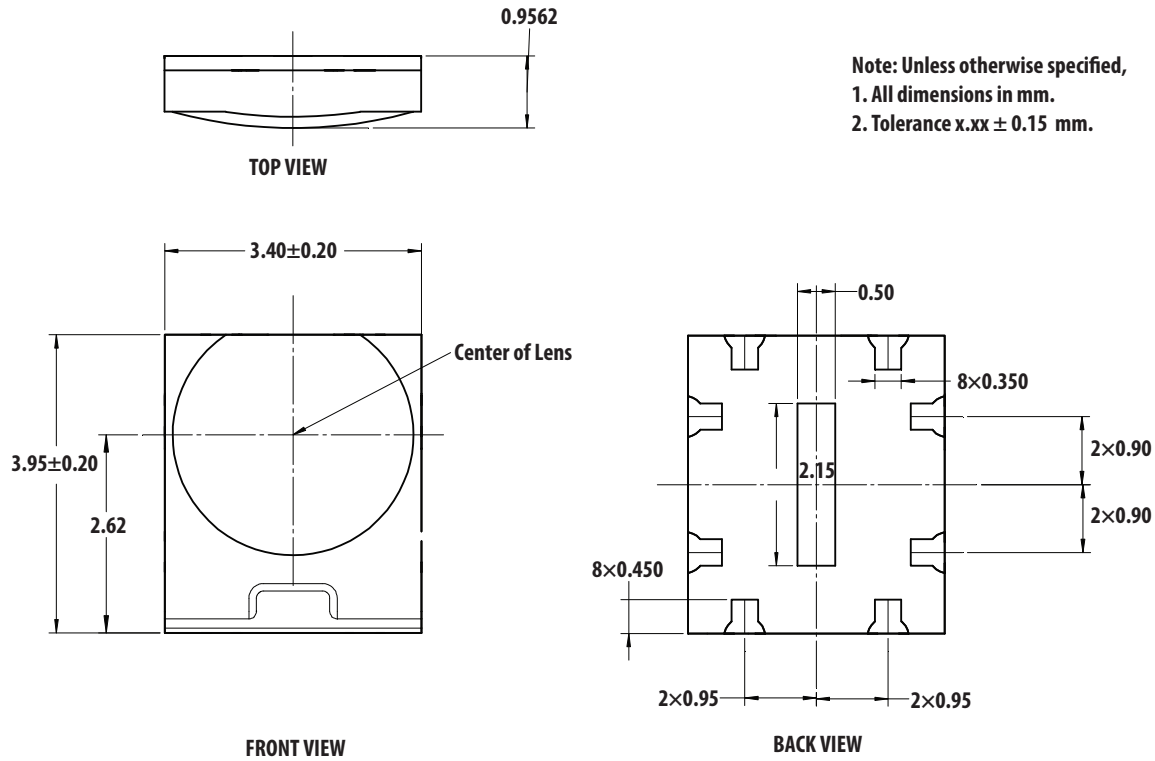

Figure 3: Codewheel Pattern for a 3-Channel Encoder



NOTE: The overall physical track count is reduced but not the counts per revolution (CPR). The CPR *remains the same* because the count during this index transition is generated by an intelligent signal processing circuit.

Package Outline Drawing



Recommended Land Pattern

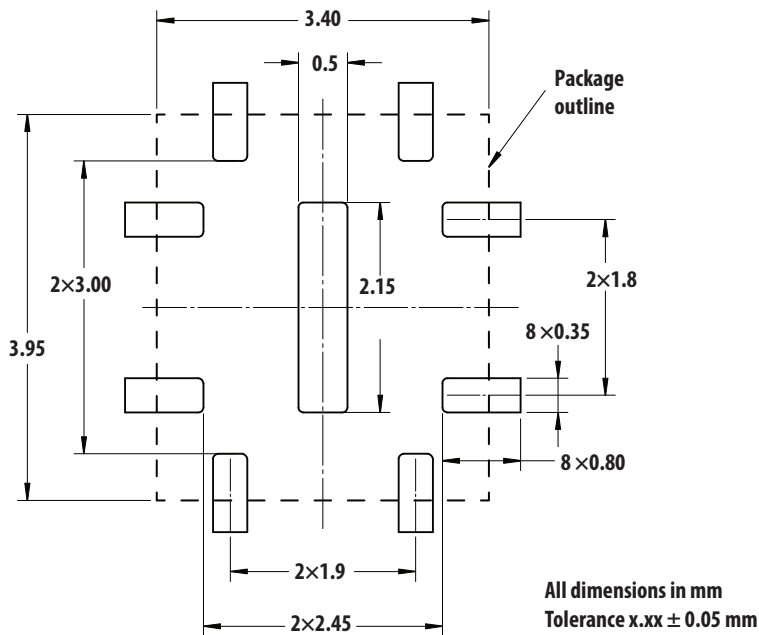

Encoder Placement Orientation and Positioning

The AEDR-872x is designed such that both the emitter and the detector ICs are placed parallel to the window/bar orientation, *with the encoder mounted on top of the codewheel* (see below right). When properly oriented, the detector side will be closer to the center of codewheel than the emitter. More importantly, *the center of the lens* of the encoder unit must be aligned with the codewheel (R_{OP}), or more specifically tangential to the center point of L_W (1/2 of the length of the window).

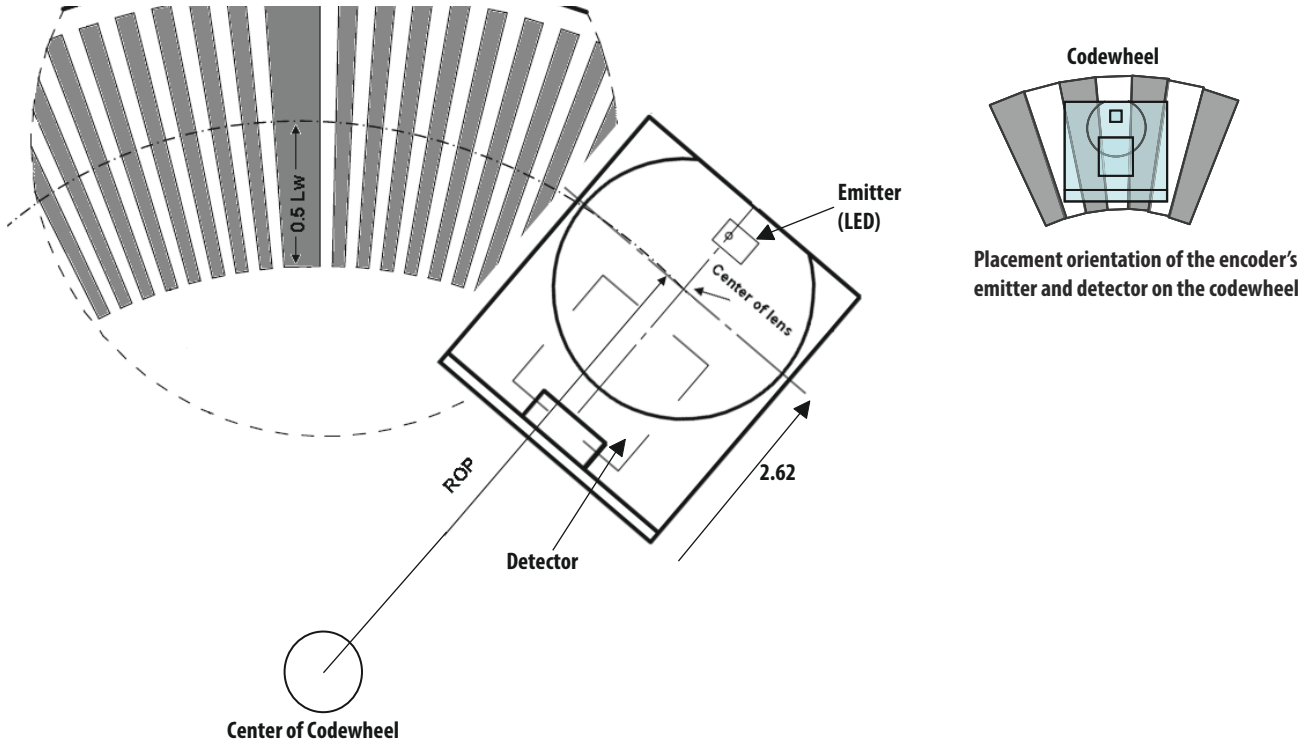

Center of the lens should be aligned with the R_{OP} of the codewheel

Direction of Movement

With the detector side of the encoder placed closer to the codewheel (see the figure on the previous page), Channel A leads Channel B when the codewheel rotates anti-clockwise and vice versa (*with the encoder mounted on top of the codewheel*). The optimal gap setting recommended is between 0.5 mm to 1.0 mm (see the side view below).

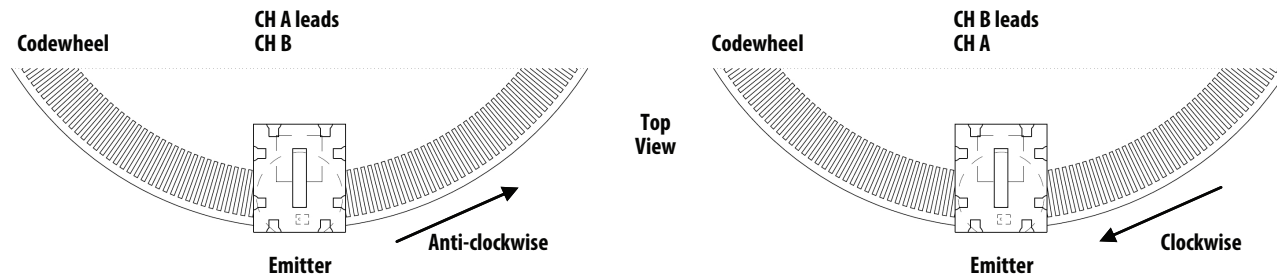
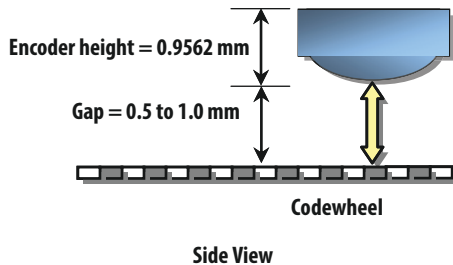

Note: Drawing not to scale

Moisture Sensitivity Level

The AEDR-872x is specified to Moisture Sensitive Level (MSL) 3. Precaution is required to handle this moisture-sensitive product to ensure the reliability of the product.

Storage before use:

- An unopened moisture barrier bag (MBB) can be stored at <math>< 40^{\circ}\text{C}/90\% \text{ RH}</math> for 12 months.
- It is not recommended that the MBB is opened before assembly.

Control after the MBB is opened:

- Encoder that will be subjected to reflow solder must be mounted within 168 hours of factory condition <math>< 30^{\circ}\text{C}/60\% \text{ RH}</math>.

Control for unfinished reel:

- Stored and sealed MBB with desiccant or desiccators at <math>< 5\% \text{ RH}</math>.

Baking is required if:

- Humidity indicator card (HIC) is > 10% when read at $23^{\circ}\text{C} \pm 5^{\circ}\text{C}$.
- The encoder floor life exceeded 168 hours.
- Recommended baking condition: $60^{\circ}\text{C} \pm 5^{\circ}\text{C}$ for 20 hours (tape and reel), $125^{\circ}\text{C} \pm 5^{\circ}\text{C}$ for 5 hours (loose unit).

Recommended Lead-free Reflow Soldering Temperature Profile

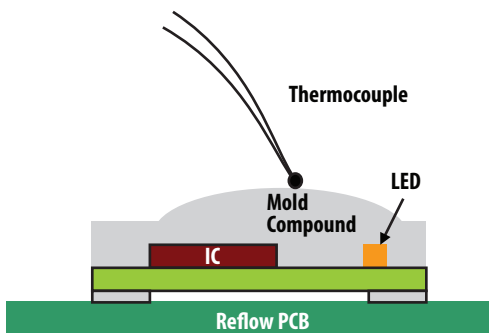
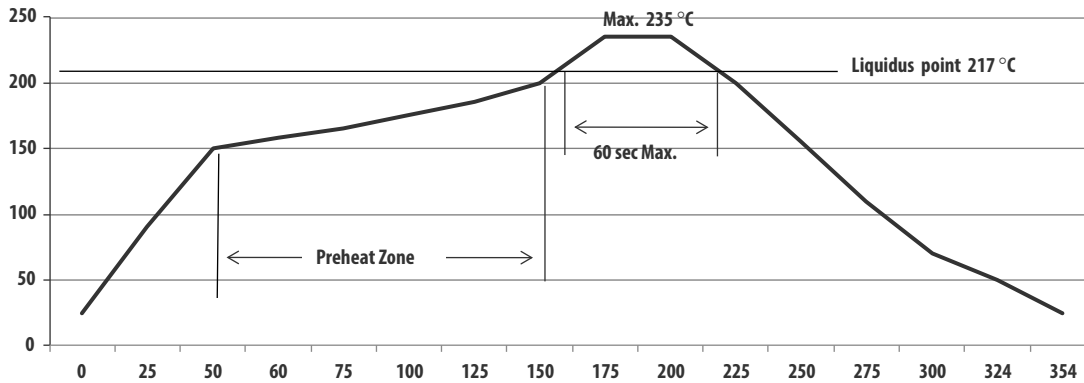

| | |
|-------------------------------------|------------------|
| Average ramp up rate | = 3°C/s |
| Average ramp down rate | = 6°C/s |
| Preheat temperature | = 150°C to 200°C |
| Preheat time | = 60s to 100s |
| Time maintain above 217°C | = 40s to 60s |
| Peak temperature | = 235°C |
| Time within 5°C of peak temperature | = 20s to 30s |

NOTE:

1. Reflow with peak temperature > 235°C may damage the component.
2. Due to treatment of high temperature, this clear compound may turn yellow after IR reflow.
3. Profile shown here is the actual readings from the thermocouple (attached to AEDR-872x as shown above) on the reflow board PCB.

Tape and Reel Information

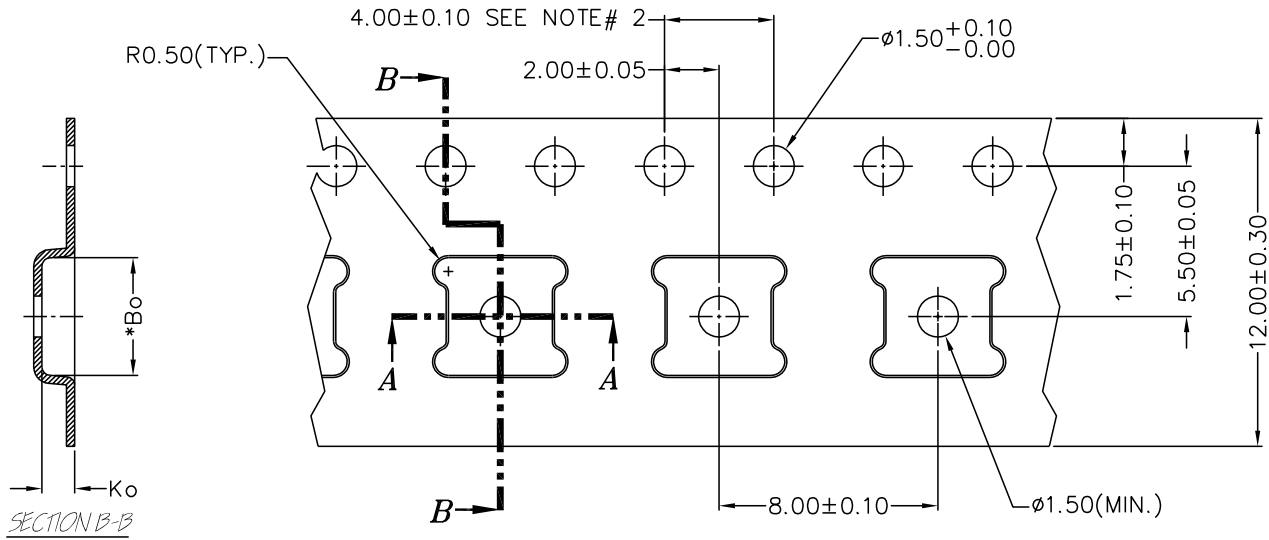

SECTION B-B

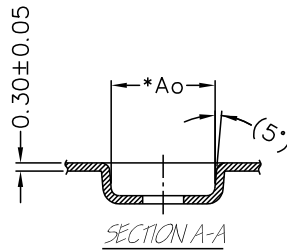

- NOTES: -
- * Ao & Bo measured at 0.3mm above base of pocket.
 - 10 pitches cumulative tol. ±0.2mm.
 - () Reference dimensions only.

| | |
|--------|-------|
| Ao: | 3.80 |
| Bo: | 4.30 |
| Ko: | 1.20 |
| Pitch: | 8.00 |
| Width: | 12.00 |

Order Information

AEDR - 87xx - x0x

| | | | | |
|---------------------------|--|-------------------|-----------------------|-----------------------------|
| Output Signal | Index Gating | Packaging | Resolution LPI | Shipping Units |
| 1 - Digital 2 - Analog | 0 - Gated 90°e 1 - Gated 180°e 2 - Gated 360°e 3* - Tag 360°e | 1 - Tape and Reel | 0 - 318 | 0 - 1000 pcs 2 - 100 pcs |

Notes:
 Digital 3.3V and 5V operating mode
 Analog: 5V operating mode only
 3* applicable only for analog output