

## AEDR-9820

### Three-Channel Reflective Incremental Encoders with Analog and Digital Output (225 LPI)

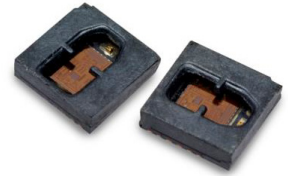

#### Description

The Broadcom<sup>®</sup> AEDR-9820 is a three-channel reflective optical encoder. It can be configured to analog or digital outputs employing reflective technology for motion control purposes. The selectable options available are two channels differential analog with a third channel differential digital or analog index output or three-channel digital differential A, B, and I output.

The AEDR-9820 in analog encoder mode with two-channel differential analog outputs (Sin, /Sin, Cos, /Cos) can be interfaced directly with external interpolators.

The AEDR-9820 in digital encoder mode offers two-channel (AB) quadrature digital outputs and a third channel digital index output. Being TTL compatible, the outputs of the AEDR-9820 encoder can be interfaced with most of the signal processing circuitries. Therefore, the encoder provides easy integration and flexible design into existing systems.

The AEDR-9820 encoder is designed to operate over  $-40^{\circ}\text{C}$  to  $115^{\circ}\text{C}$  temperature range and is suitable for commercial, industrial, and automotive end applications.

The encoder houses an infrared LED light source and a photodetecting circuitry in a single package. The small size of  $4.00\text{ mm (L)} \times 4.00\text{ mm (W)} \times 1.05\text{ mm (H)}$  allows it to be used in a wide range of miniature commercial applications, where size and space are primary concerns.

**Disclaimer:** Except as expressly indicated in writing, the component is not designed or warranted to be suitable for use in safety-related applications where its failure or malfunction can reasonably be expected to result in injury, death, or severe equipment damage. Customers are solely responsible for determining the suitability of this product for its intended application and solely liable for all loss, damage, expense or liability in connection with such use.

#### Features

- Analog output option: two-channel differential analog output and differential digital or analog index output
- Digital output option: three-channel differential or TTL compatible; two-channel quadrature (AB) digital outputs for direction sensing and a third channel, index digital output
- Built-in interpolator for 1x, 2x, 4x, 8x, and 16x interpolation
- Surface mount leadless package:  $4.0\text{ mm (L)} \times 4.0\text{ mm (W)} \times 1.05\text{ mm (H)}$
- Operating voltage of 3.3V and 5.0V supply
- Built-in LED current regulation
- Wide operating temperature range from  $-40^{\circ}\text{C}$  to  $115^{\circ}\text{C}$
- High encoding resolution: 225 LPI (lines/in.) or 8.86 LPmm (lines/mm)

#### Applications

- Closed-loop stepper motors
- Small motors, actuators
- Industrial printers
- Robotics
- Card readers
- Pan-tilt-zoom camera
- Portable medical equipment
- Optometric equipment
- Linear stages

# Output Waveform

Figure 1: Analog Output Option

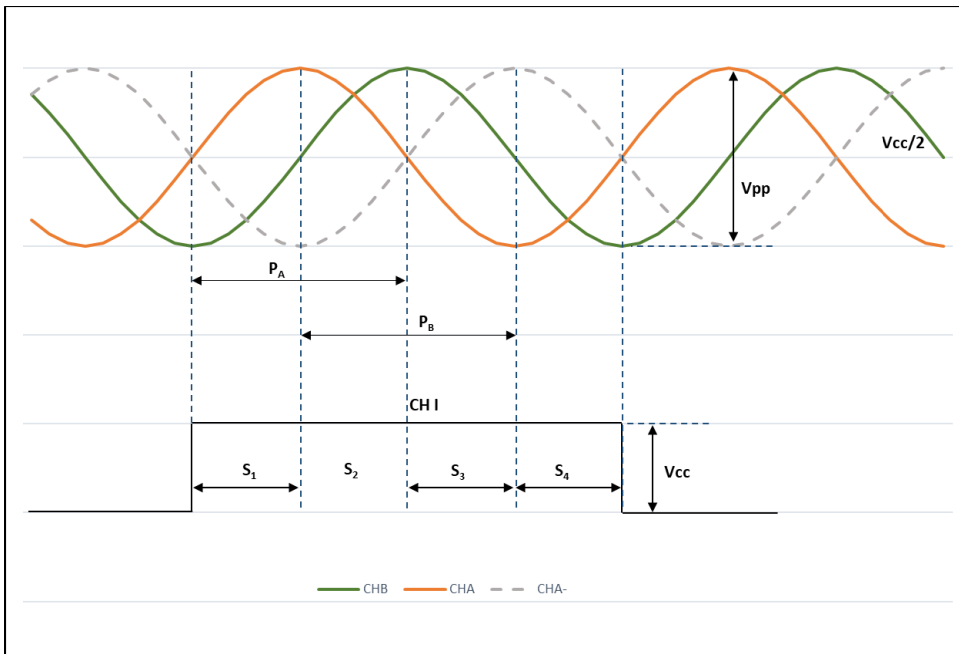
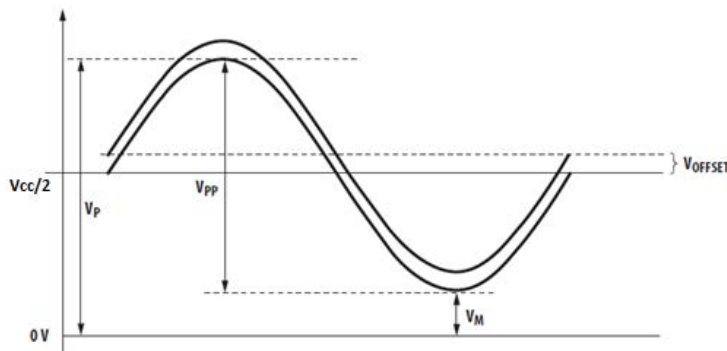

Figure 2: Code Wheel Rotation Movement (Counterclockwise)



## Analog Parameter Definitions

Test	Parameter	Definition
Analog Peak-to-Peak	Vpp	The peak-to-peak signal magnitude in V of the analog signal.
Analog Offset	V <sub>OFFSET</sub>	The offset in mV from the mid-point of the analog peak-to-peak signal to the zero voltage point.
Analog Peak/Valley Voltage	V <sub>PA</sub> , V <sub>PB</sub> V <sub>MA</sub> , V <sub>MB</sub>	The value in V of the peak/valley of the analog signal (that is, one-sided reading).
Analog Peak-to-Peak Voltage	V <sub>PPA</sub> , V <sub>PPB</sub>	The absolute difference between V <sub>P</sub> and V <sub>M</sub> of channel A or B.

# Digital Output Option

Figure 3: Sample of Output Waveforms

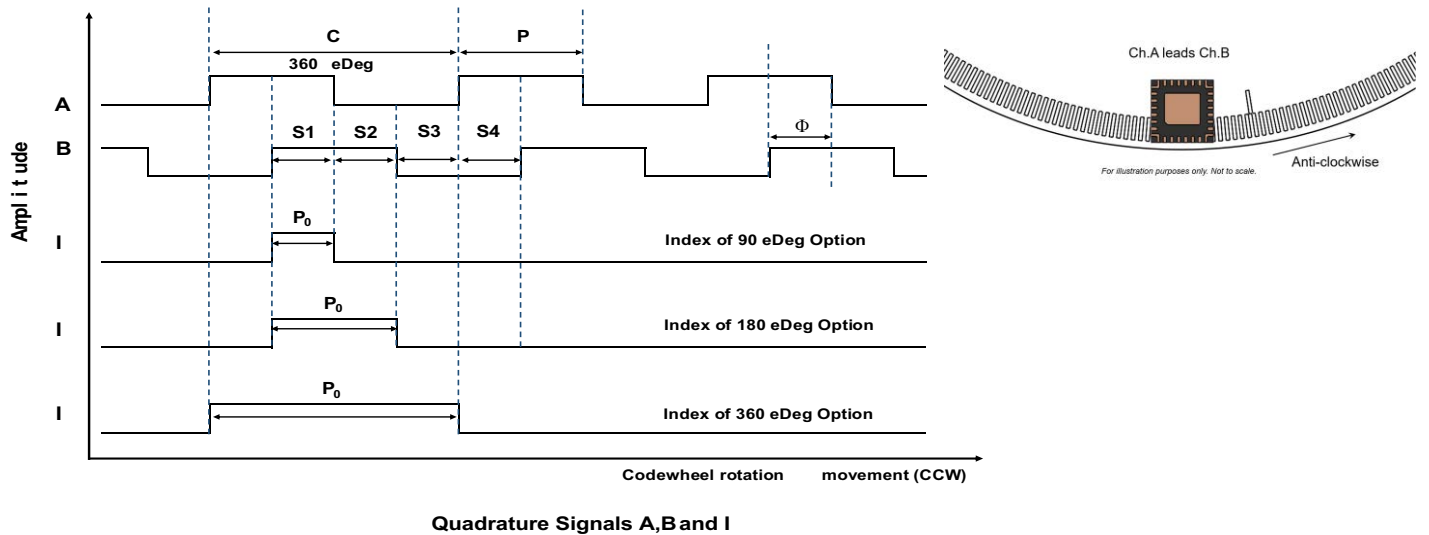

## Digital Parameter Definitions

Test	Parameter	Definition
Count	N	The number of bar and window pairs or counts per revolution (CPR) of the code wheel.
Cycle	C	360 electrical degrees ( $^{\circ}e$ ), 1 bar and window pair. One shaft rotation: 360 mechanical degrees, N cycles.
Cycle Error	$\Delta C$	An indication of cycle uniformity. The difference between an observed shaft angle that gives rise to one electrical cycle, and the nominal angular increment of $1/N$ of a revolution.
Pulse Width (Duty) Error	$\Delta P$	The deviation, in electrical degrees, of the pulse width from its ideal value of $180^{\circ}e$ .
State	S	The number of electrical degrees between a transition in the output of channel A and the neighboring transition in the output of channel B. There are four states per cycle, each nominally $90^{\circ}e$ .
Phase	$\phi$	The number of electrical degrees between the center of the high state of channel A and the center of the high state of channel B. This value is nominally $90^{\circ}e$ for quadrature output.
Optical Radius	$R_{OP}$	The distance from the code wheel's center of rotation to the optical center (O.C.) of the encoder module.
Index Pulse Width	$P_0$	The number of electrical degrees that an index is high in one cycle.

## Absolute Maximum Ratings

Parameter	Symbol	Value
Storage Temperature	$T_S$	-40°C to 125°C
Operating Temperature	$T_A$	-40°C to 115°C
Supply Voltage	$V_{CC}$	7V

### NOTE:

1. Proper operation of the encoder cannot be guaranteed if the maximum ratings are exceeded.
2. Remove the Kapton tape only after the SMT reflow process and just before final assembly. Take precautions to keep the encoder ASIC clean at all times.
3. Some particles may be present on the surface of the encoder ASIC surface. The presence of these particles do not degrade the performance of the encoder.

**CAUTION!** Take anti-static discharge precautions when handling the encoder to avoid damage, degradation, or both, induced by ESD.

## Recommended Operating Conditions

Parameter	Symbol	Min.	Typ.	Max.	Units	Notes
Operating Temperature	$T_A$	-40	25	115	°C	
Supply Voltage	$V_{CC}$	2.97	3.3	3.63	V	Ripple < 100 mVp-p
		4.5	5	5.5		
Current	$I_{CC}$	—	30	65	mA	No load
Pin Current (All I/O Outputs)	$I$	-20	—	20	mA	
Maximum Output Frequency	$F$	—	—	200	kHz	At 1x interpolation
		—	—	400	kHz	At 2x interpolation
		—	—	800	kHz	At 4x interpolation
		—	—	1.6	MHz	At 8x interpolation
		—	—	2	MHz	At 16x interpolation
Radial Misalignment	$E_R$	—	—	± 0.2	mm	
Tangential Misalignment	$E_T$	—	—	± 0.2	mm	
Tilt Misalignment	$E_\theta$	—	—	± 2.0	°	
Code Wheel Gap	$G$	0.5	1.00	1.5	mm	

## Power-Up Behavior

When the AEDR-9820 is powered on, the A, B, and I digital outputs are invalid until after the initial first state of either the Ch A or Ch B signal.

## Encoder Pinout

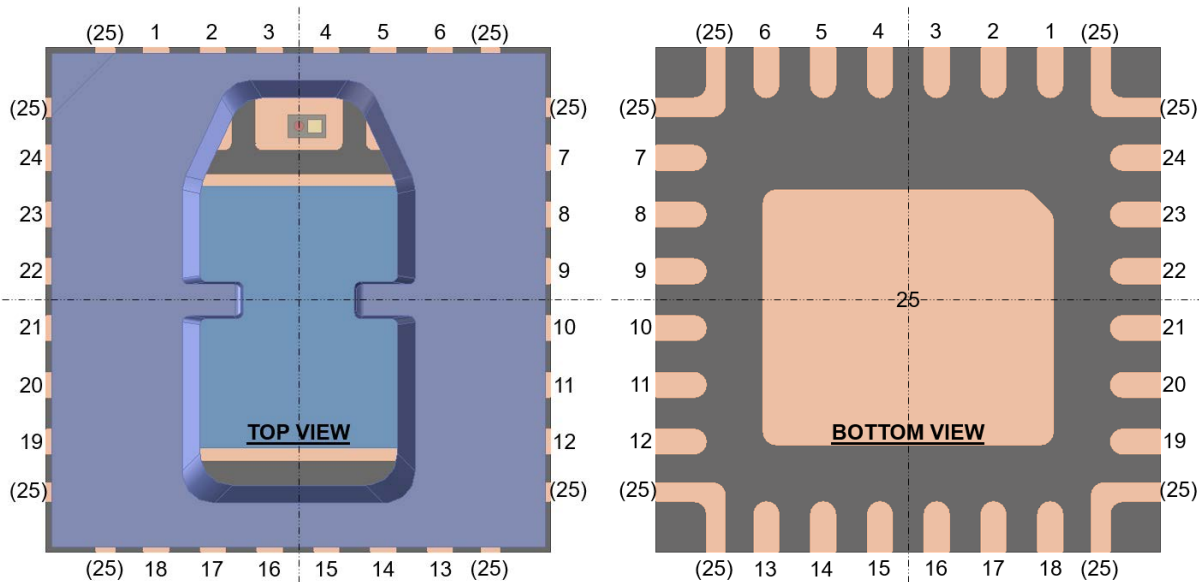

Pin	Name	Function
1	CH_A/A+	Digital A+/Analog Sin+
2	N.C. <sup>a</sup>	—
3	LED ANODE	LED Anode
4	LED ANODE	LED Anode
5	LED CATHODE	LED Cathode
6	LED REG	LED Regulation
7	VDDA/VCC	Analog Supply Voltage
8	VSSA/AGND	Analog Ground
9	SEL2	Mode Selection 2
10	SEL1	Mode Selection 1
11	INDEX_N/I-	Index Output Z- (Digital/Analog)
12	INDEX_P/I+	Index Output Z+ (Digital/Analog)
13	N.C.	—

a. N.C. – No connect.

Pin	Name	Function
14	N.C.	—
15	N.C.	—
16	N.C.	—
17	N.C.	—
18	N.C.	—
19	INDEX_SEL	Index Control
20	CH_BB/B-	Digital B-/Analog Cos-
21	CH_B/B+	Digital B+/Analog Cos+
22	VSSD/DGND	Digital Ground
23	VDD	Digital Supply Voltage
24	CH_AB/A-	Digital A-/Analog Sin-
25	VSSA	Analog Ground
(25)	N.C.	—

### NOTE:

1. No connection to all corner pads indicated as (25).
2. Connect pin 8, pin 22, and pin 25 to common ground for all digital or analog mode applications. Pin 25 is the center pad of the package.
3. Both pin 7 and pin 23 must be powered during operation.
4. Both pin 5 and Pin 6 must be connected together.

## Select Options – Encoder Built-In Interpolation

SEL 1 <sup>a</sup>	SEL 2 <sup>a</sup>	IND SEL	Interpolation Factor	Index	Maximum Output Frequency	CPR at ROP 4.6 mm	CPR at ROP 11 mm
Open	Open	Low	1X	Gated 90°e	200 kHz	256	612
		High		Gated 180°e			
		Open		Ungated raw			
Open	Low	Low	2X	Gated 90°e	400 kHz	512	1224
		High		Gated 180°e			
		Open		Gated 360°e			
High	High	Low	4X	Gated 90°e	800 kHz	1024	2448
		High		Gated 180°e			
		Open		Gated 360°e			
Low	Low	Low	8X	Gated 90°e	1.6 MHz	2048	4896
		High		Gated 180°e			
		Open		Gated 360°e			
High	Low	Low	16X	Gated 90°e	2.0 MHz	4096	9792
		High		Gated 180°e			
		Open		Gated 360°e			
Open	High	N/A	Analog (500 mVpp)	Analog	200 kHz	N/A	N/A
Low	High	N/A	Analog 1 Vpp	Ungated Digital			
High/Low	Open	N/A	Analog 1 Vpp	Analog			

a. Open selection must be connected to the middle of a voltage divider circuit.

Figure 4: Example of Voltage Divider Circuit

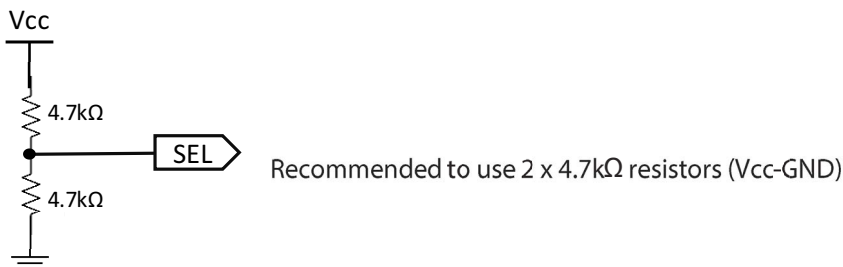

The digital interpolation factor above may be used with the following equations to cater to various rotational speed (RPM) and count per revolution (CPR).

$$\text{RPM} = (\text{Count Frequency} \times 60) / \text{CPR}$$

The CPR (at 1X interpolation) is based on the following equation that is dependent on radius of operation (R<sub>OP</sub>).

$$\text{CPR} = \text{LPI} \times 2\pi \times \text{ROP (in.)} \text{ or } \text{CPR} = \text{LP mm} \times 2\pi \times \text{ROP (mm)}$$

**NOTE:** LPmm (lines per mm) = LPI / 25.4.

## Recommended Setup for the Power Supply Pins and General Routing

Both VDDA, VDD, and the respective grounds (VSSA and VSSD) are to be connected as shown in [Figure 5](#). Be sure to follow these schematic design rules:

- Use a pair of 22- $\mu$ F and 0.1- $\mu$ F capacitors as bypass on VDD and VDDA. Place them in parallel as close as possible to the encoder ASIC package, in between the power and ground pins.
- Avoid routing the INDEX trace in parallel and close to the analog signals to reduce the INDEX signal switching noise from coupling into the analog signal.
- Design separate VDD and VDDA traces.
- Minimize trace or cable length wherever possible.
- For single-ended applications, do not ground the Output- from the encoder. Allow the output to float.

**Figure 5: Reference Schematic Diagram for AEDR-9820**

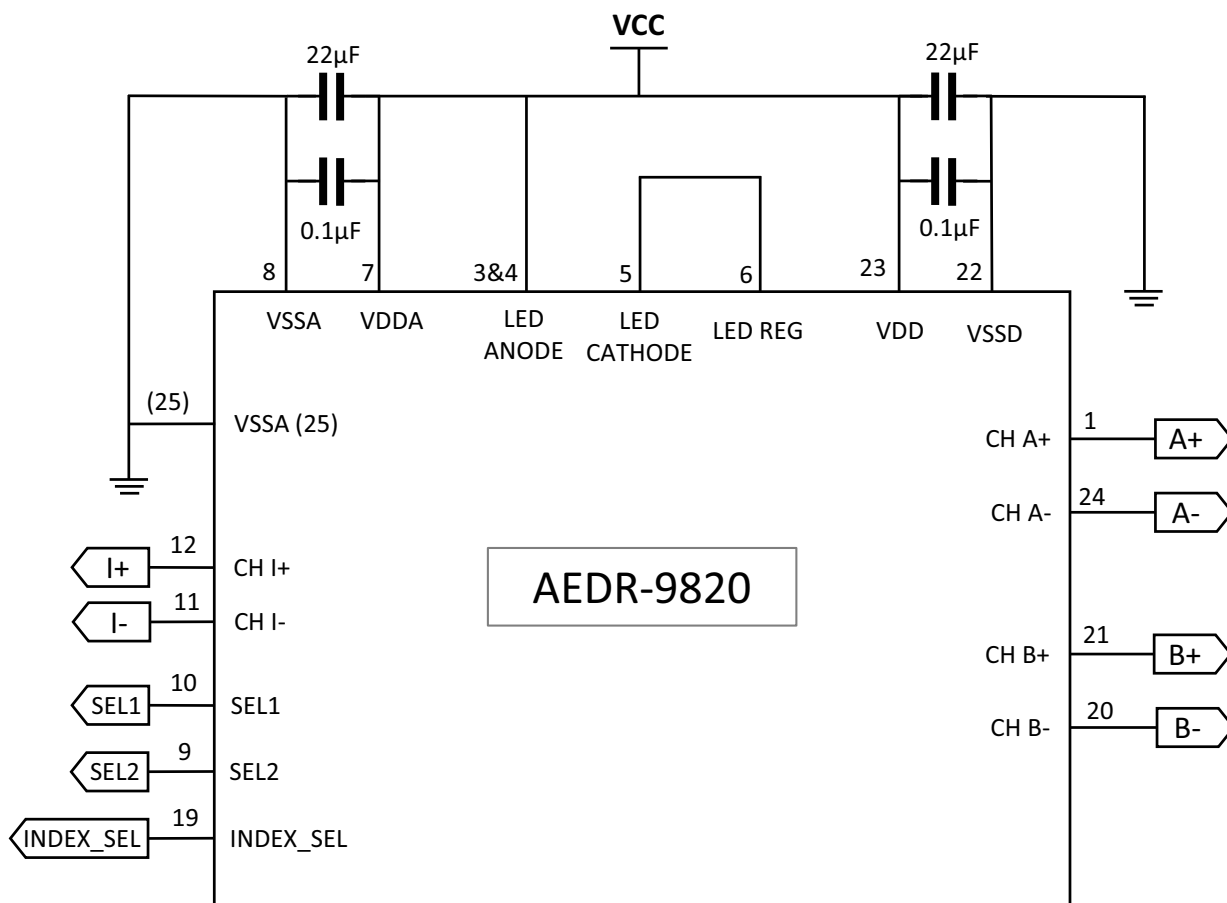

### NOTE:

1. Pin 25 is the center pad of the package and is designated as AGND.
2. See the table in [Select Options – Encoder Built-In Interpolation](#) for SEL1X, SEL2X, and IND SEL configurations.

## Analog Encoder Characteristics

Parameter	Symbol	Min.	Typ. <sup>a, b</sup>	Max.	Units
Peak-to-Peak Voltage (Average)	$V_{PPA}, V_{PPB}$	0.9	1.0	1.1	V
		0.45	0.50	0.55	V
Analog Offset Voltage	$V_{OFFSETA}, V_{OFFSETB}$	$0.45 V_{CC}$	$0.5 V_{CC}$	$0.55 V_{CC}$	V
Voltage Reference (Midpoint of Signal Vpp)	Vref	—	$V_{CC}/2$	—	V

a. The optimal performance of encoder depends on the motor/system setup condition of the individual customer.

b. Typical values represent the average value of encoder performance in Broadcom factory-based setup conditions.

## Digital Encoder Characteristics (Code Wheel of $R_{OP}$ at 4.6 mm)

Parameter	Symbol	Dynamic Performance <sup>a</sup>					Units
		Typical <sup>b</sup>					
		1X	2X	4X	8X	16X	
Interpolation Factor							
Cycle Error	$\Delta C$	$\pm 7$	$\pm 12$	$\pm 21$	$\pm 28$	$\pm 35$	$^{\circ}e$
Pulse Width (Duty) Error	$\Delta P$	$\pm 6$	$\pm 13$	$\pm 14$	$\pm 18$	$\pm 25$	$^{\circ}e$
Phase Error	$\Delta \phi$	$\pm 3$	$\pm 7$	$\pm 7$	$\pm 9$	$\pm 9$	$^{\circ}e$
State Error	$\Delta S$	$\pm 6$	$\pm 8$	$\pm 11$	$\pm 12$	$\pm 14$	$^{\circ}e$
Index Pulse Width (Gated 90°)	$P_O$	90	90	90	90	90	$^{\circ}e$
Index Pulse Width (Gated 180°)	$P_O$	180	180	180	180	180	$^{\circ}e$
Index Pulse Width (Gated 360°)	$P_O$	NA	360	360	360	360	$^{\circ}e$
Index Pulse Width (Raw Ungated)	$P_O$	330	N/A	N/A	N/A	N/A	$^{\circ}e$

a. The optimal performance of the encoder depends on the motor/system setup and the code wheel type and condition.

b. Typical values represent the average value of encoder performance based on factory setup conditions at 12k RPM with a metal code wheel.

## Electrical Characteristics

Characteristics over recommended operating conditions at 25°C.

Parameter	Symbol	Min.	Typ.	Max.	Units	Notes
High Level Output Voltage	$V_{OH}$	2.4	—	—	V	$I_{OH} = -20$ mA
Low Level Output Voltage	$V_{OL}$	—	—	0.4	V	$I_{OH} = +20$ mA
Output Current per Channel, $I_{out}$	$I_O$	—	—	20	mA	
Rise Time <sup>a</sup>	$t_r$	—	< 50	—	ns	CL ≤ 50 pF
Fall Time <sup>a</sup>	$t_f$	—	< 50	—	ns	

a. Applicable for all digital modes except Index in Analog mode.



## Code Wheel Characteristics

Characteristics are based on a Broadcom-qualified code wheel supplier. Contact Broadcom for information regarding qualified reflective code wheel suppliers.

Parameter	Symbol	Min.	Typ.	Max.	Unit	Notes
Specular Reflectance	$R_f$	60%	—	—	—	Reflective area
		—	—	5%	—	Non-reflective area
LED Peak Wavelength	$\lambda_p$	—	853	—	nm	

## Code Wheel Design Guidelines

- The window tracks are reflective surfaces, and the bar tracks are opaque surfaces; all window and bar tracks are trapezoid.
- The number of Incremental window/bar tracks depend on the CPR; and the Incremental windows/bars have the same width value.
- There is an offset between the Incremental window tracks and the Index window track.
- There is only one Index window track, and its width is constant.
- The center point to form the Incremental Optical Radius ( $R_{OP}$ ) and the Index  $R_{OP}$  are two different points, except for 256 CPR.

Figure 6: Code Wheel Design (A)

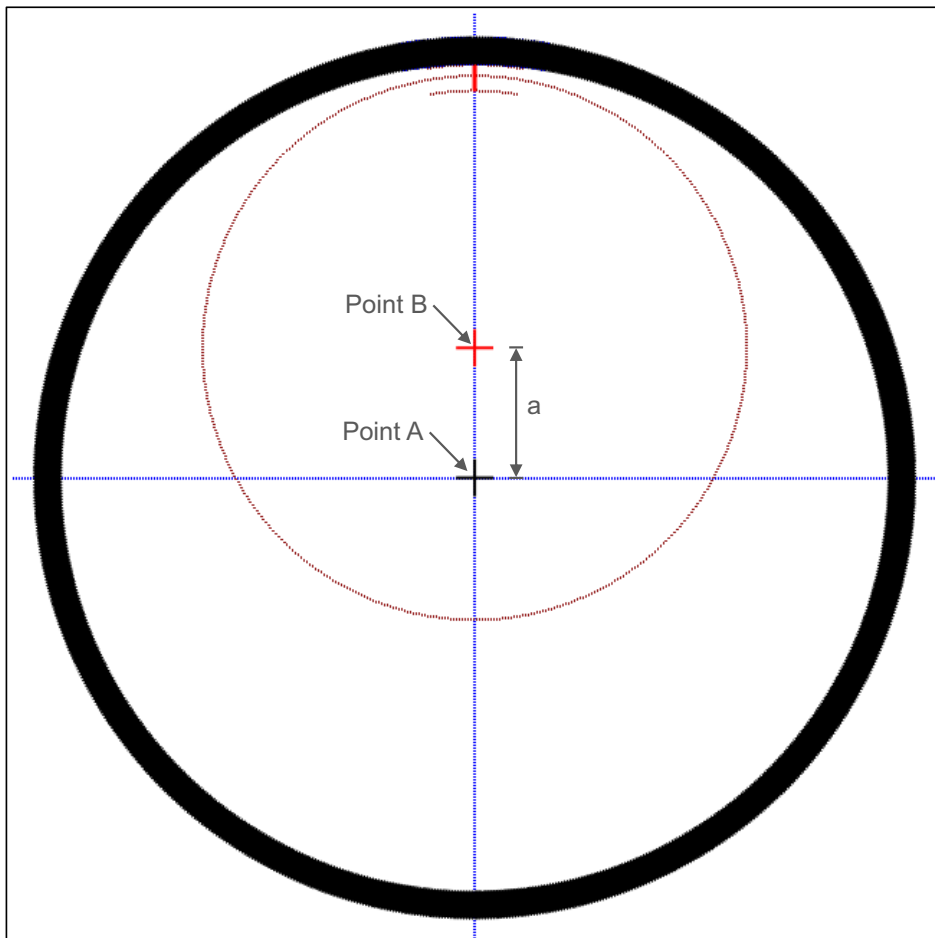
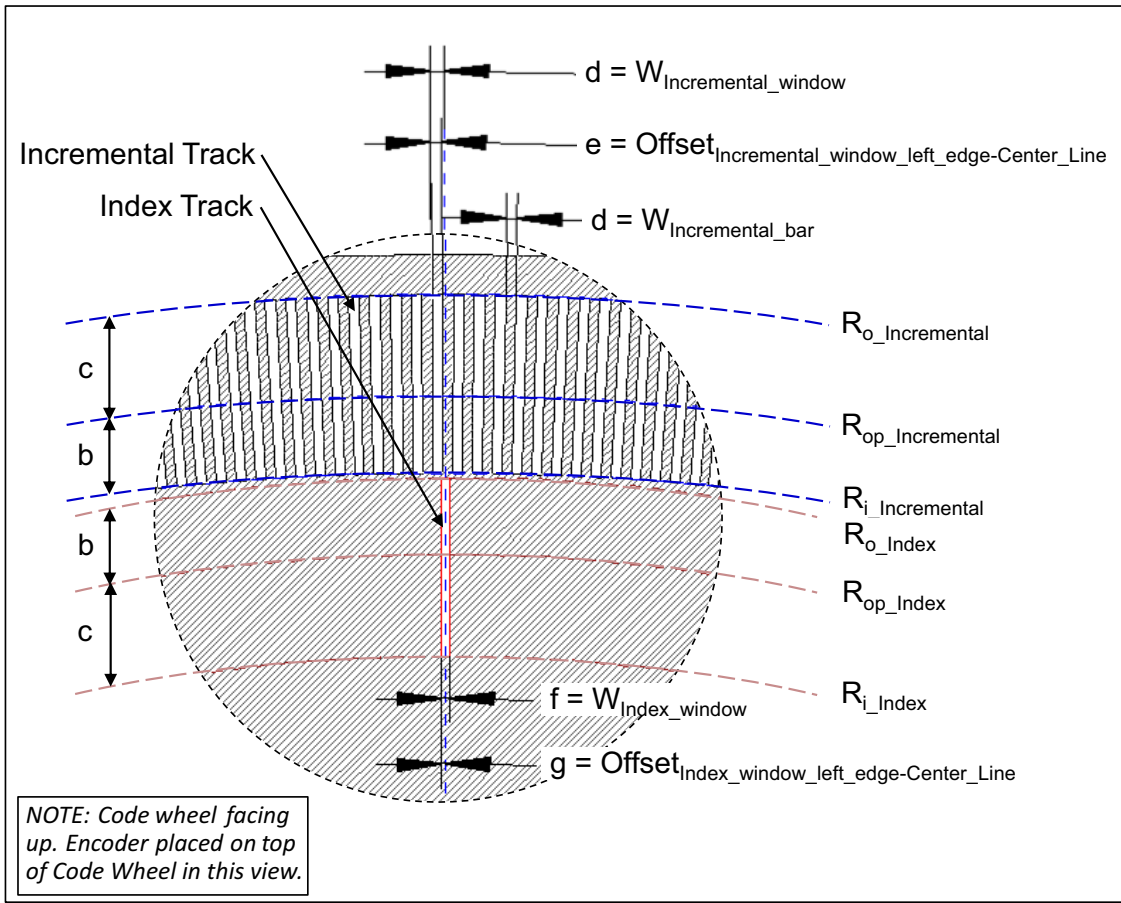

Figure 7: Code Wheel Design (B)



Dimension	Formula	Constant for AEDR-9820
$R_{op\_Incremental}$ (mm)	$(25.4 / 225) \times (CPR / 2\pi)$	—
$R_{op\_Index}$ (mm)	—	R4.0485 from Point B
$R_{o\_Incremental}$	$R_{op\_Incremental} + c$	—
$R_{i\_Incremental}$	$R_{op\_Incremental} - b$	—
$R_{o\_Index}$	$R_{op\_Index} + b$	—
$R_{i\_Index}$	$R_{op\_Index} - c$	—
$a$ (mm)	$R_{op\_Incremental} - 4.5995$	—
$b$ (mm)	$(0.551 - h) / 2$	—
$c$ (mm)	$R_{o\_Incremental} - R_{op\_Incremental}$ or $R_{op\_Index} - R_{i\_Index}$	$\geq 0.35$
$d$ (°)	$(\text{Pitch} / 2)$ or $((360 / CPR) / 2)$	—
$e$ (°)	$1.25d$	—
$f$ (°)	—	0.7031
$g$ (°)	$f / 2$	0.3516
$h$ (mm)	$R_{o\_Index} - R_{i\_Incremental}$ at Y-axis	$0 \geq h \geq 0.05$

## Code Wheel Design Example

The following demonstrates a code wheel design for the AEDR-9820 at 256 CPR.

Determine $R_{op\_Incremental}$	$(25.4 / 225) \times (256 / 2\pi)$	$\approx 4.5995$ mm
Determine $R_{o\_Incremental}$	$4.5995 + 0.35$	$= 4.9495$ mm
Determine $R_{i\_Incremental}$	$4.5995 - (0.551 / 2)$	$= 4.3240$ mm
Determine Pitch	$360 / 256$	$= 1.4062^\circ$
Determine $d$	$1.406 / 2$	$= 0.7031^\circ$
Determine $e$	$1.25 \times 0.703$	$= 0.8789^\circ$

With the preceding information, draw a trapezoid based on Point A (0, 0), populate 256x at pitch = 1.4062°

Determine $a$	$4.5995 - 4.5995$	$= 0$ mm
$R_{op\_Index}$		$= 4.0485$ mm
$R_{o\_Index}$	$4.0485 + (0.551 / 2)$	$= 4.3240$ mm
$R_{i\_Index}$	$4.0485 - 0.35$	$= 3.6985$ mm
$f$		$= 0.7031^\circ$
$g$	$f / 2$	$= 0.3516^\circ$

With the preceding information, draw a trapezoid based on Point B (0, 0)

The following demonstrates a code wheel design for the AEDR-9820 at 1024 CPR.

Determine $R_{op\_Incremental}$	$(25.4 / 225) \times (1024 / 2\pi)$	$\approx 18.3980$ mm
Determine $R_{o\_Incremental}$	$18.3980 + 0.35$	$= 18.7480$ mm
Determine $R_{i\_Incremental}$	$18.3980 - (0.551 / 2)$	$= 18.1225$ mm
Determine Pitch	$360 / 1024$	$= 0.3516^\circ$
Determine $d$	$0.3516 / 2$	$= 0.1758^\circ$
Determine $e$	$1.25 \times 0.1758$	$= 0.2197^\circ$

With the preceding information, draw a trapezoid based on Point A (0, 0), populate 1024x at pitch = 0.3516°

Determine $a$	$18.3980 - 4.5995$	$= 13.7985$ mm
$R_{op\_Index}$		$= 4.0485$ mm
$R_{o\_Index}$	$4.0485 + (0.551 / 2)$	$= 4.3240$ mm
$R_{i\_Index}$	$4.0485 - 0.35$	$= 3.6985$ mm
$f$		$= 0.7031^\circ$
$g$	$f / 2$	$= 0.3515^\circ$

With the preceding information, draw a trapezoid based on Point B (0, 13.7985)

# Code Strip Design Guideline

- The Incremental/Index window track is reflective surface and the Incremental bar track is opaque.
- The window width is denoted by  $W_{window}$  and the bar width is denoted by  $W_{bar}$ .
- All windows and bars has the same width value,  $d$ .
- There is an offset between Incremental window track and Index window track, denoted by  $e$ .

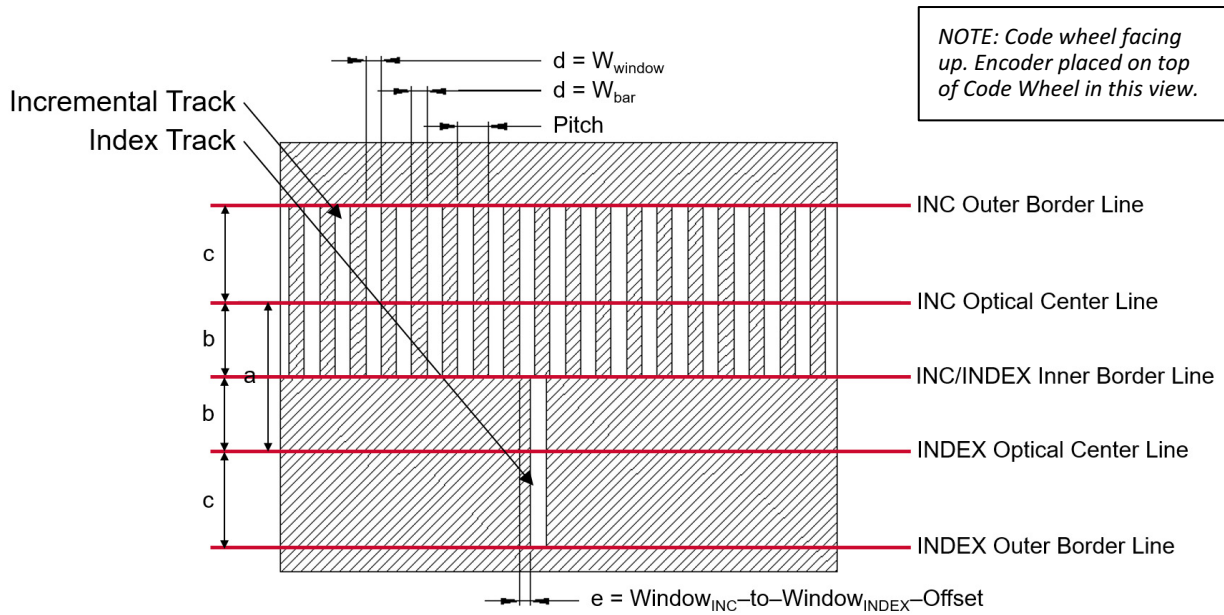

Dimension	Formula	225 LPI
Pitch (mm)	$25.4 / \text{LPI}$	0.113
$a$ (mm)	$R_{OP\_INC} - R_{OP\_INDEX}$	0.551
$b$ (mm)	$R_{OP\_INC} - R_{I\_INC}$ or $R_{O\_INDEX} - R_{OP\_INDEX}$	$a / 2$
$c$ (mm)	$R_{O\_INC} - R_{OP\_INC}$ or $R_{OP\_INDEX} - R_{I\_INDEX}$	0.35
$d$ (mm)	$\text{Pitch} / 2$	0.057
$e$ (mm)	$(3 / 4) \times d$	0.042

## Multiple Index Pulse Code Wheel or Strip Design Guideline

For a pseudo absolute encoder application, the multiple Index pulse can be designed into the code wheel or the code strip. The minimum index bar width is 3x the incremental pitch.

The recommended multiple Index pulse design guideline is shown in the following figure.

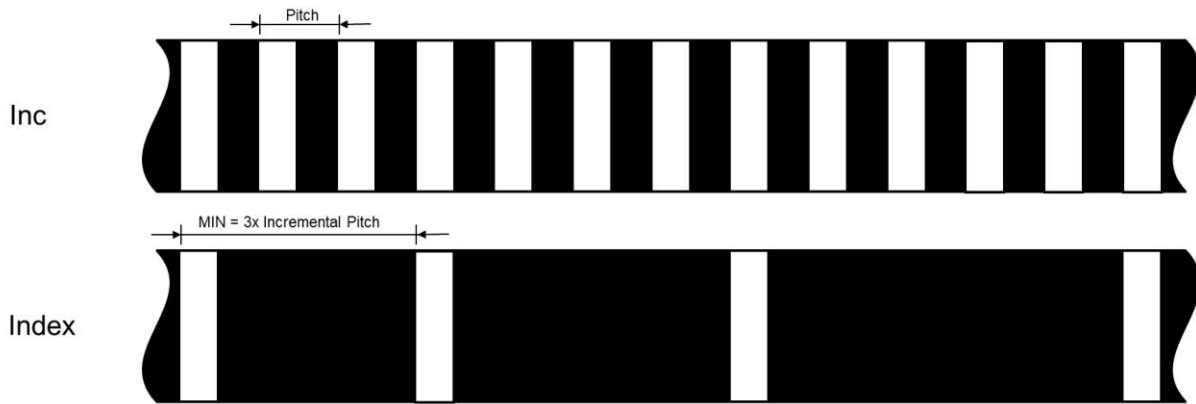

### Example 1

LPI	= 225
Pitch	= 1inch / 225
	≈ 113um
Min Index Pitch	= 3 * 113
	= 339um

### Example 2

CPR	= 612
Pitch	= 360° / 612
	= 0.59°
Min Index Pitch	= 3 * 0.59
	= 1.76°

# Package Outline Drawing

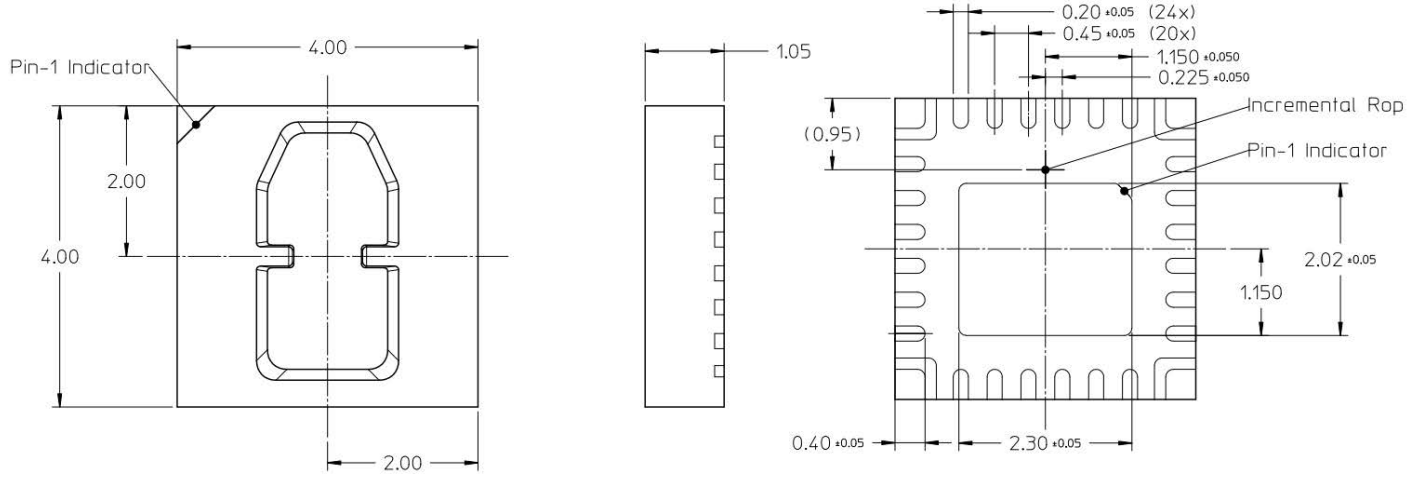

**NOTE:**

1. All dimensions are in mm.
2. Tolerance is x.xx ± 0.15 mm.

# Recommended Land Pattern

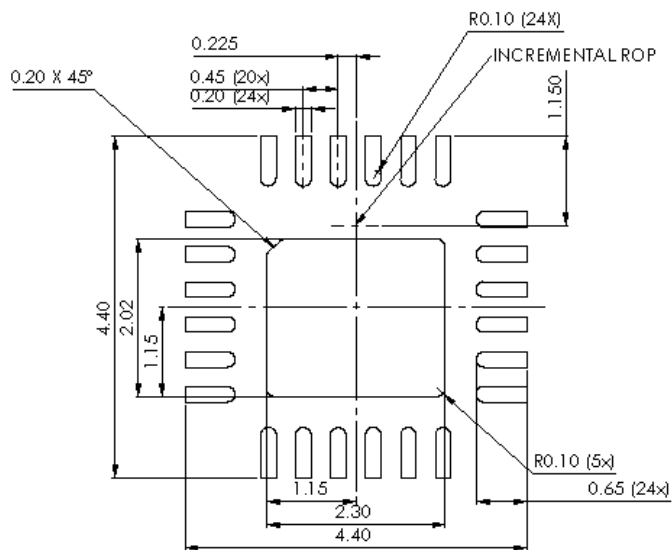

**NOTE:**

1. All dimensions are in mm.
2. Tolerance is x.xx ± 0.05 mm.

## Encoder Placement Orientation, Position, and Direction of Movement

The AEDR-9820 is designed with both the emitter and detector dice placed in parallel to the code wheel window/bar orientation. The encoder package mounted on the top, facing down onto the code wheel. When properly aligned, the detector side will be closer to the center of the code wheel than the emitter.

The optical center of the encoder package must be aligned tangential to the code wheel's  $R_{OP}$ . The optimal gap setting recommended is 1.00 mm, with the range of 0.50 mm to 1.50 mm.

Channel A leads Channel B when the code wheel rotates counterclockwise, and Channel B leads Channel A when the code wheel rotates clockwise.

**Figure 8: Encoder Placement Orientation**

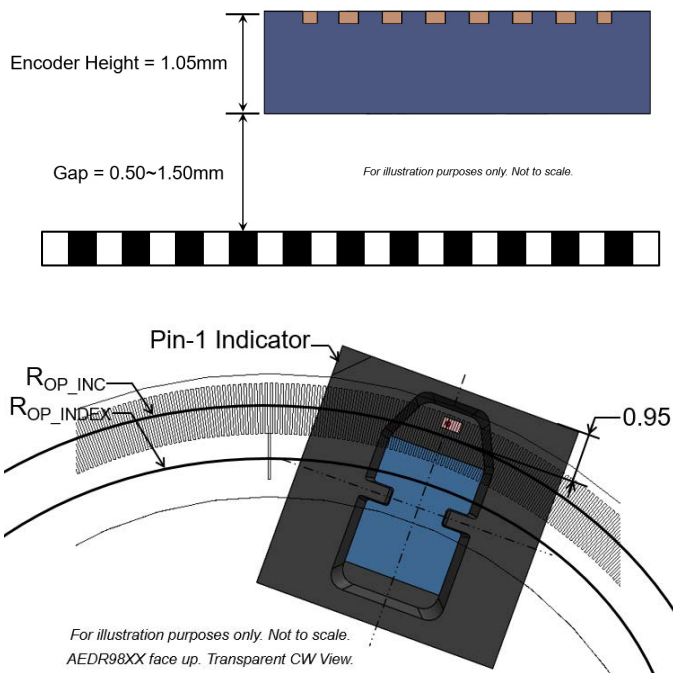
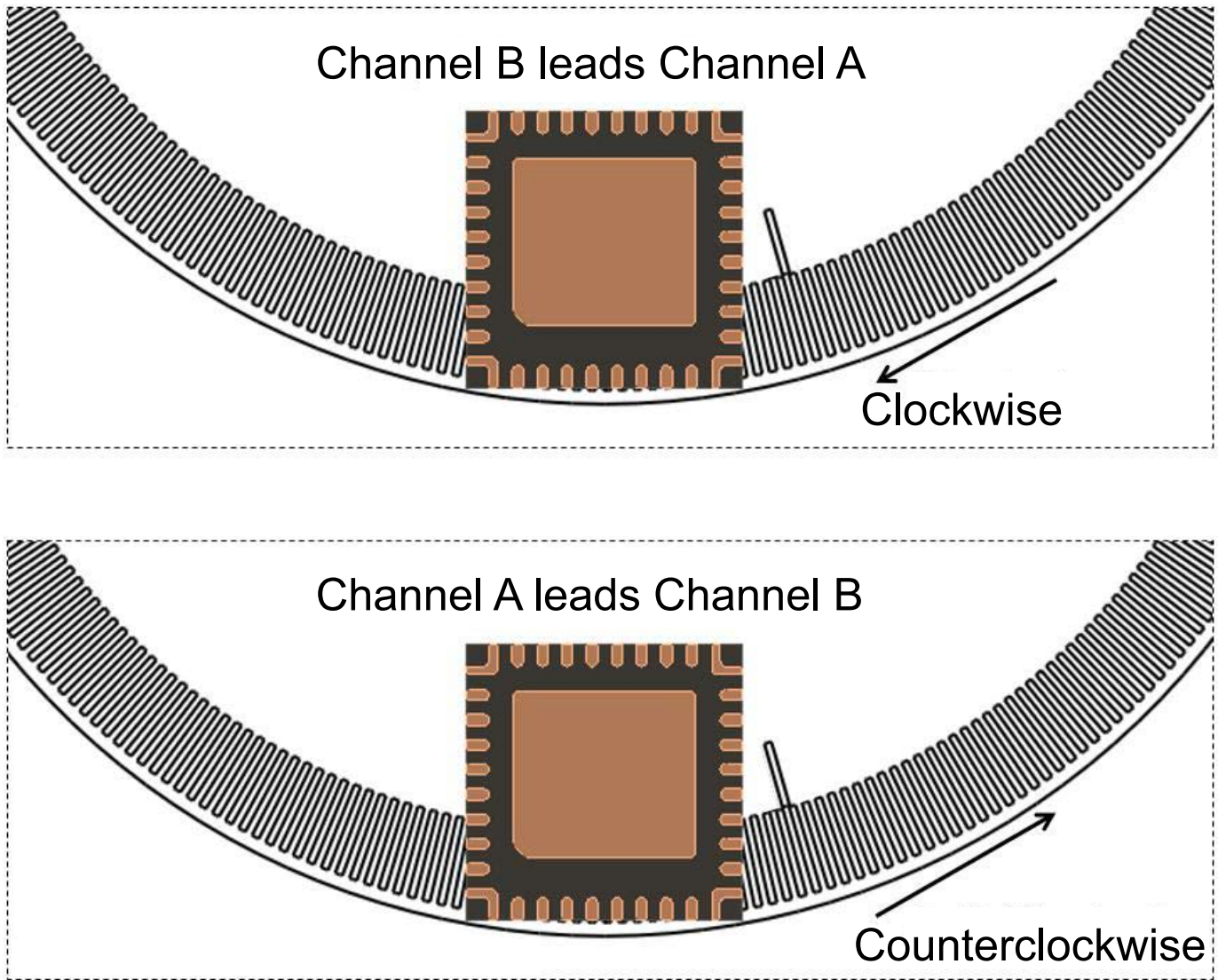

Figure 9: Channel A and Channel B Signal Output Sequence with Respect to Code Wheel Rotational Direction



**NOTE:** Drawings are for illustration purposes only and are not to scale.



## Moisture Sensitivity Level

The AEDR-9820 package is specified to moisture sensitive level 3 (MSL 3). Take precautions when handling this moisture-sensitive product to ensure the reliability of the product.

### Storage before use:

- An unopened moisture barrier bag (MBB) can be stored at  $<40^{\circ}\text{C}/90\%$  RH for 12 months.
- Open the MBB just prior to assembly.

### Control after opening the MBB:

- The encoder that will be subjected to reflow soldering must be mounted within 168 hours of exposure to factory conditions of  $<30^{\circ}\text{C}/60\%$  RH.

### Control for unfinished reel:

- Store a sealed MBB with desiccant or desiccators at  $<5\%$  RH condition.

### Baking is required if the following conditions exist:

- The humidity indicator card (HIC) is  $>10\%$  when read at  $23^{\circ}\text{C} \pm 5^{\circ}\text{C}$ .
- The encoder floor life exceeded 168 hours.

### Recommended baking condition:

- $40^{\circ}\text{C} \pm 5^{\circ}\text{C}$  for 22 hours (tape and reel) or  $125^{\circ}\text{C} \pm 10^{\circ}\text{C}$  for 1 hour (loose units).

Figure 10: Typical Lead-Free Solder Reflow Soldering Temperature Profile

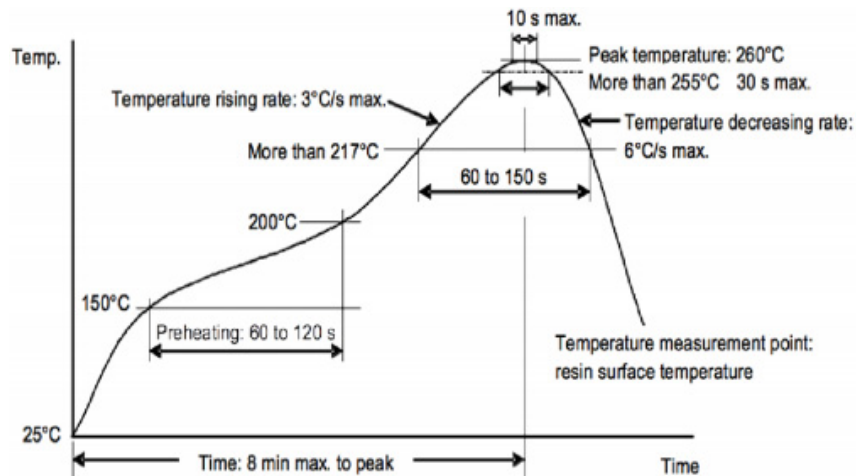

**CAUTION!** Exercise care when handling the encoder ASIC because it is a sensitive optical device. Remove the protective Kapton tape only after the reflow process and just before final assembly.

# Tape and Reel Information

Figure 11: Tape and Reel

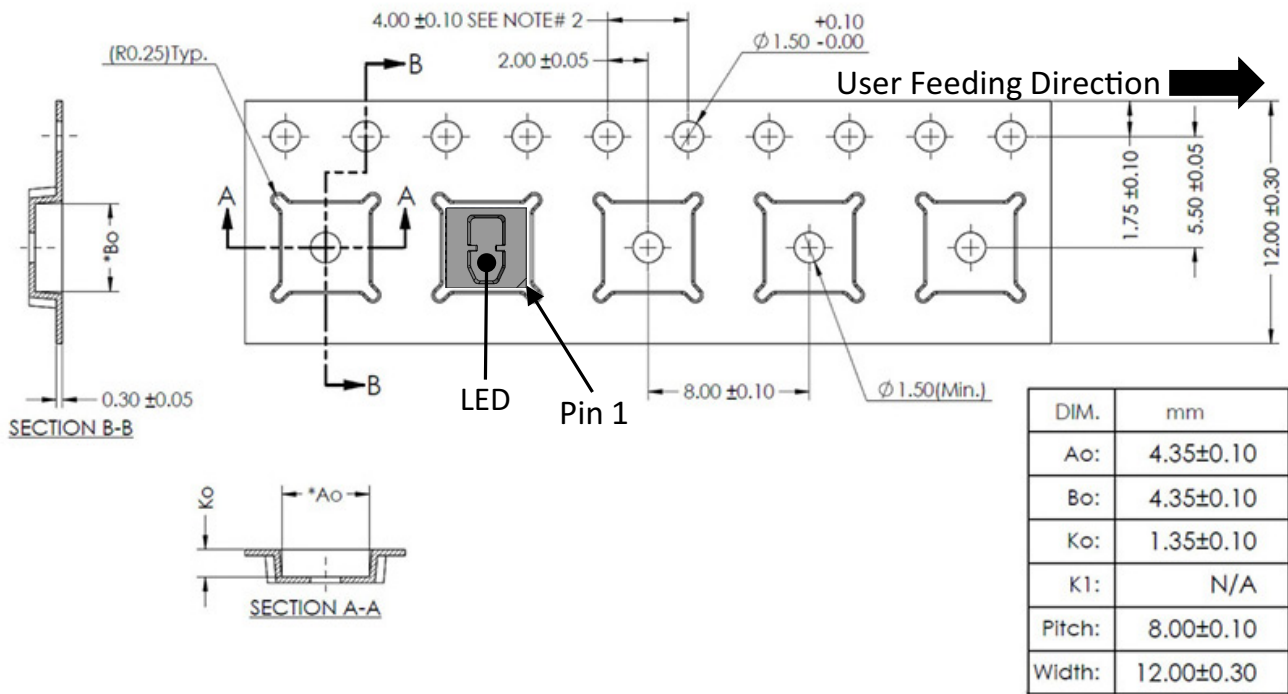
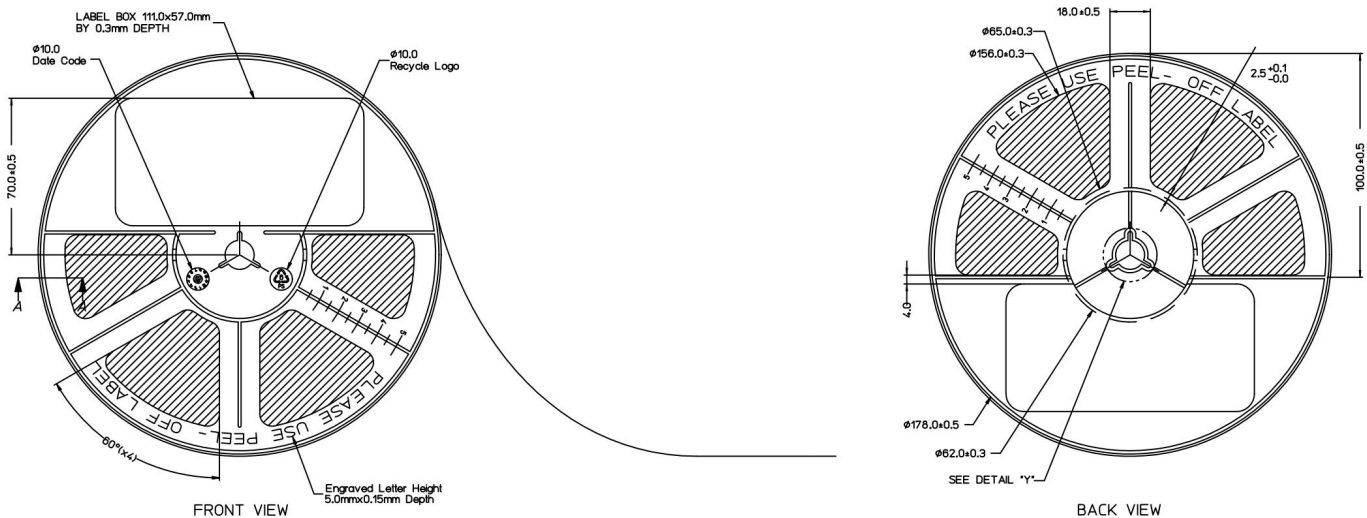
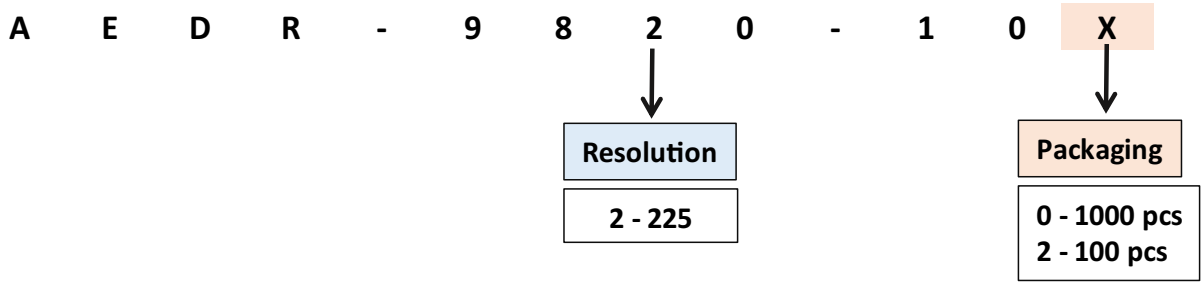

Figure 12: Reel Dimensions



## Ordering Information



## Accessories Ordering Information

Part Number	Description
HEDS-9820EVB	AEDR-9820 Evaluation Board 225 LPI Evaluation Board and Code Wheel