

## AEDT-981x

### High Temperature 115°C, High Resolution, Three Channels Optical Incremental Encoder Modules

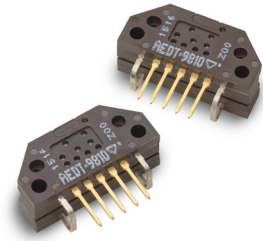

## Description

The Broadcom<sup>®</sup> AEDT-981x encoders are industrial grade high temperature (–40°C to 115°C) rating three channel optical incremental encoder modules building on the Broadcom legacy HEDS-9140 series.

Using a Broadcom-developed opto ASIC with the built-in Interpolator circuit, AEDT-981x encoders enable wide resolution range from 1000 to 5000 counts per revolution with the rotary codewheel of 11-mm optical radius, offering a high resolution yet compact solution.

With the opto-ASIC's built-in automatic LED brightness regulation technique, the encoder current consumption can be significantly lowered (Typ. I<sub>cc</sub>: 20 mA) while maintaining optimal encoder performance across spatial corners. This LED brightness control feature also enables optimal LED current control; hence, LED life can significantly prolonged.

With the state-of-the-art opto-mechanical design, AEDT-981x offers excellent spatial play of  $\varnothing$  0.40 mm and code wheel gap range of  $\pm$  150  $\mu$ m. This allows great flexibility and ease of installation to the user.

Inheriting the indefeasible integrity in product robustness, repeatability and reliability, AEDT-981x series are designed for wide market employment withstanding wide application requirement and environment demand.

## Features

- –40°C to 115°C operating temperature
- Two-channel quadrature output with index pulse
- Single-ended output with  $\pm$  5 mA output sink/source current per channel
- Suitable for industrial applications
- Resolution up to 5000 counts per revolution
- Low power consumption (typical I<sub>cc</sub>: 20 mA)
- No signal adjustment required
- Pin compatible to legacy HEDS-9xxx series
- Spatial play tolerance of  $\varnothing$  0.40 mm
- Allows motor shaft axial play of  $\pm$  0.15 mm
- ESD Immunity HBM 4kV (JESD22-A114D)

## Applications

The AEDT-981x series provide high temperature motion control detection with ease of installation, making them suitable for wide range of commercial and industrial applications.

**NOTE:** Broadcom encoders are not recommended for use in safety critical applications; for example, ABS braking systems, power steering, life support systems, and critical care medical equipment. Please contact sales representative if more clarification is needed.

**CAUTION!** It is advised that normal static precautions be taken in handling and assembly of this component to prevent damage and/or degradation that may be induced by ESD.

# Package Dimensions

Figure 1: AEDT-9810

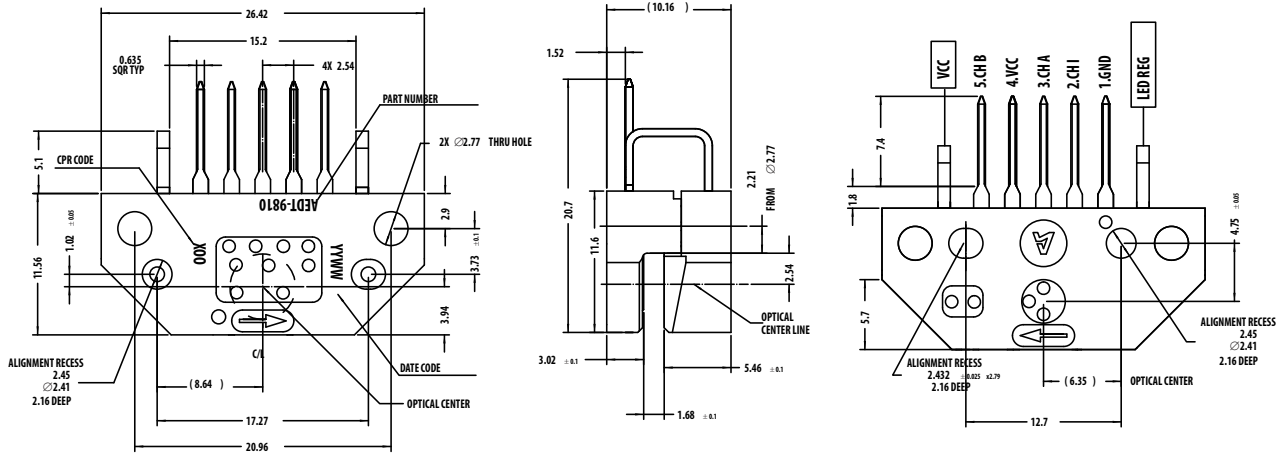
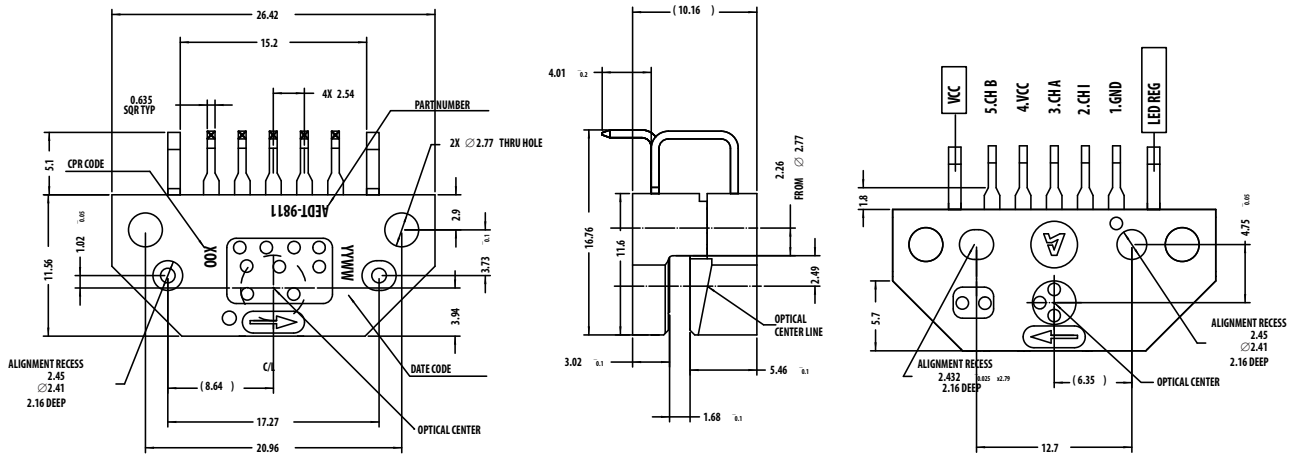

Figure 2: AEDT-9811



# Mounting Considerations with Aligning Pin

The AEDT-981X can be mounted using fixed aligning pins on the motor base. For this configuration, Side A or B can be used as the mounting plane as shown.

Figure 3: Mounting Considerations

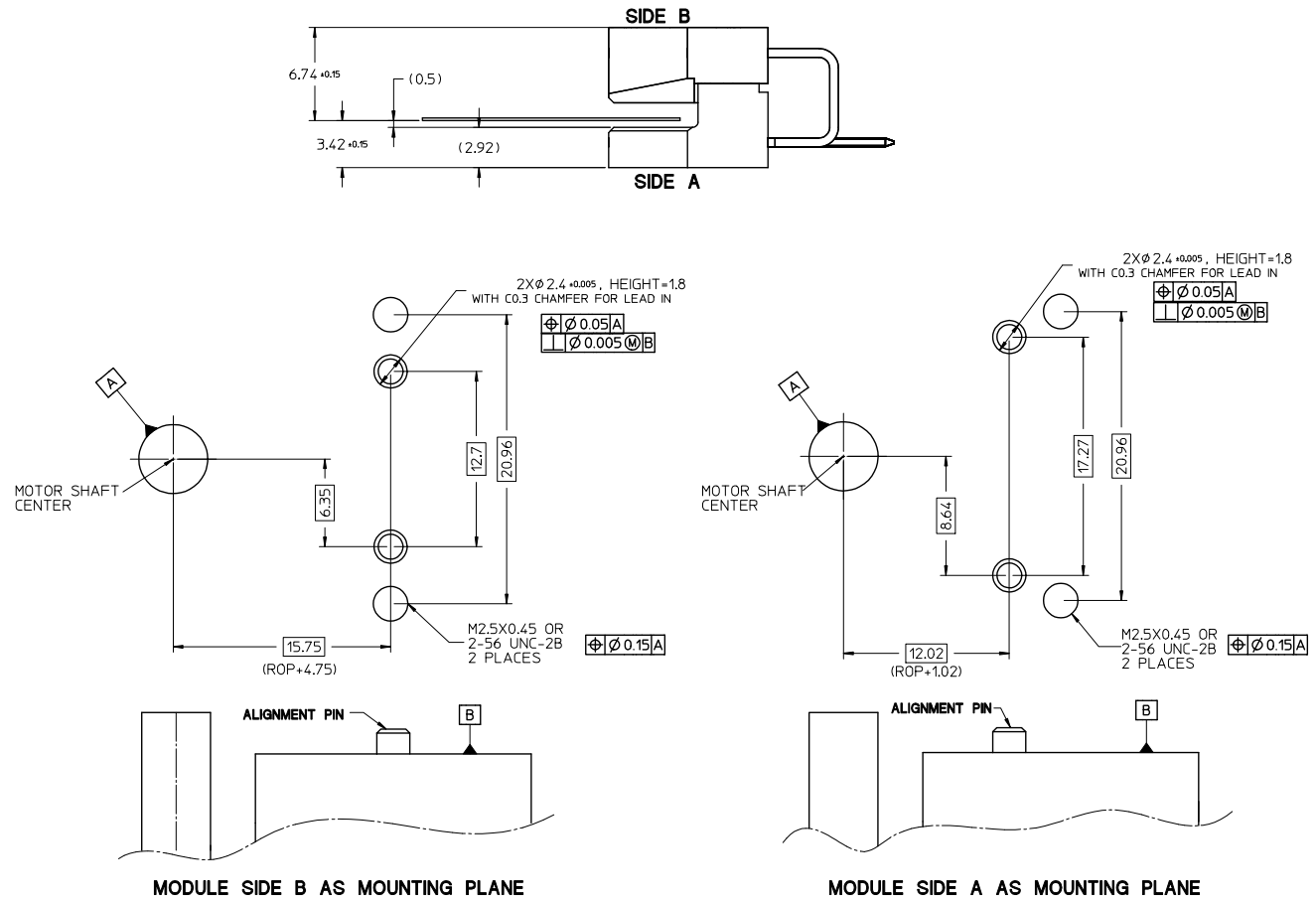

## Orientation of Artwork for Codewheels

The Index area on the AEDT-981X series encoder modules has a nonsymmetrical pattern as does the mating codewheel. For the Index to operate, the “Rightreading” side of the codewheel disk (the “Artwork Side”) must point toward “Side A” of the module (the side with the connecting pins).

Because the encoder module may be used with either “Side A” or with “Side B” toward the mounting surface, care must be taken to orientate the codewheel artwork side according to the following figure.

**Figure 4: Artwork Orientation for Codewheels**

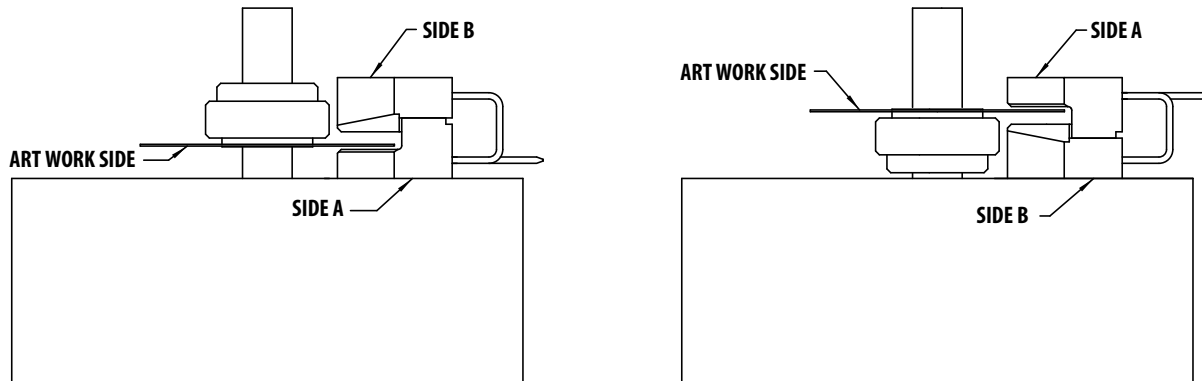

# Output Waveforms

Figure 5: Output Waveforms

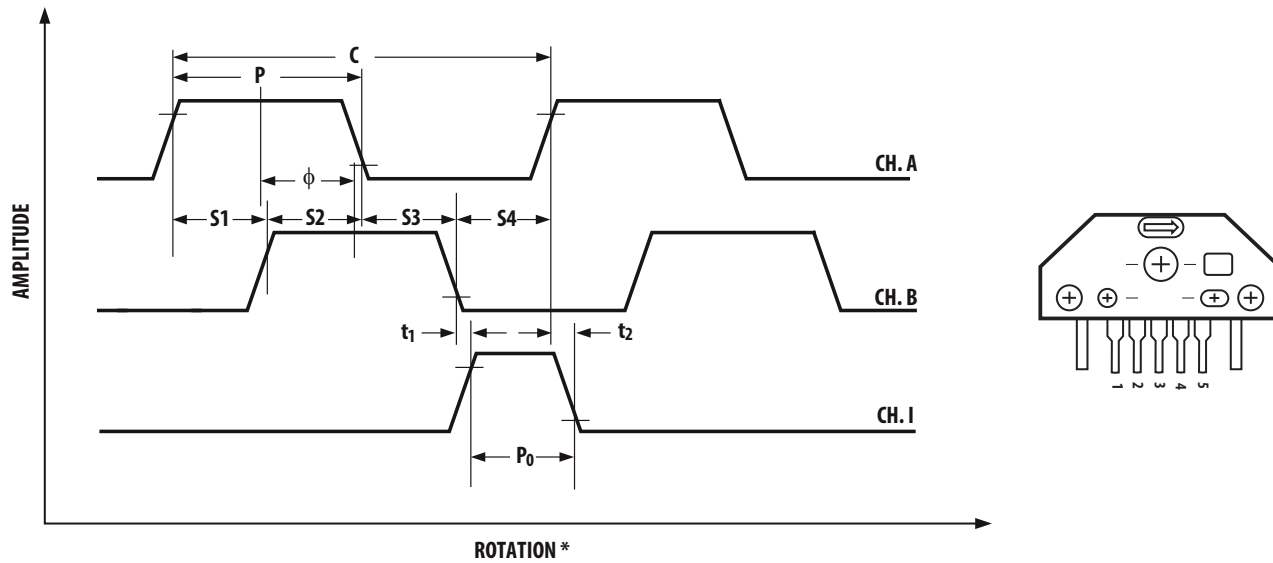

\* SPIN DIRECTION FOLLOWS ARROW MARKING ON ENCODER

## Definitions

**Count (N):** The number of bar and window pairs or counts per revolution (CPR) of the codewheel.

**One Cycle (C):** 360 electrical degrees (°e), one bar and window pair.

**One Shaft Rotation:** 360 mechanical degrees, N cycles.

**Position Error ( $\Delta\Theta$ ):** The normalized angular difference between the actual shaft position and the position indicated by the encoder cycle count.

**Cycle Error ( $\Delta C$ ):** An indication of cycle uniformity. The difference between an observed shaft angle that gives rise to one electrical cycle, and the nominal angular increment of  $1/N$  of a revolution.

**Pulse Width (P):** The number of electrical degrees that an output is high during 1 cycle. This value is nominally  $180^\circ e$  or  $1/2$  cycle.

**Pulse Width Error ( $\Delta P$ ):** The deviation, in electrical degrees, of the pulse width from its ideal value of  $180^\circ e$ .

**State Width (S):** The number of electrical degrees between a transition in the output of channel A and the neighboring transition in the output of channel B. There are four states per cycle, each nominally  $90^\circ e$ .

**State Width Error ( $\Delta S$ ):** The deviation, in electrical degrees, of each state width from its ideal value of  $90^\circ e$ .

**Phase ( $\phi$ ):** The number of electrical degrees between the center of the high state of channel A and the center of the high state of channel B. This value is nominally  $90^\circ e$  for quadrature output.

**Phase Error ( $\Delta\phi$ ):** The deviation of the phase from its ideal value of  $90^\circ e$ .

**Direction of Rotation:** When the codewheel rotates in the direction of the arrow on top of the module, channel A will lead channel B. If the codewheel rotates in the opposite direction, channel B will lead channel A.

**Optical Radius ( $R_{OP}$ ):** The distance from the codewheel's center of rotation to the optical center (O.C.) of the encoder module.

**Index Pulse Width ( $P_0$ ):** The number of electrical degrees that an index is high during one full shaft rotation. This value is nominally  $90^\circ e$  or  $1/4$  cycle.

## Absolute Maximum Ratings

Parameter	Symbol	Minimum	Maximum	Units
Storage Temperature	$T_S$	-40	125	°C
Operating Temperature	$T_A$	-40	115	°C
Supply Voltage	$V_{CC}$	-0.5	7	V
Output Voltage	$V_O$	-0.5	$V_{CC}$	V
Output Current per Channel	$I_{OUT}$	—	±5	mA
Velocity		—	12,000 <sup>a</sup>	RPM

a. Velocity 12000 RPM applies to 5000 counts per revolution.

## Recommended Operating Conditions

Parameter	Symbol	Min.	Typ.	Max.	Units	Notes
Temperature	$T_A$	-40	—	115	°C	
Supply Voltage	$V_{CC}$	4.5	5.0	5.5	Volt	Ripple < 100 mVp-p
Load Capacitance	$C_L$	—	—	100	pF	
Output Frequency	f	—	—	500	kHz	2000–2500 CPR
		—	—	1,000	kHz	4000–5000 CPR
Shaft Perpendicularity Plus Axial Displacement		—	—	± 0.15 (± 0.006)	mm (in.)	
Spatial play (including shaft eccentricity)		—	—	Ø0.40 (0.016)	mm (in.)	

## Encoding Characteristics

Encoding characteristics are applicable per the recommended operating conditions, unless otherwise specified. Values are for the worst case error over the full rotation.

### Encoder Resolution $\geq 4000$ CPR

Parameter	Symbol	Min.	Typ. <sup>a</sup>	Max.	Units
Pulse Width Error	$\Delta P$	—	21	45	$^{\circ}e$
Logic State Width Error	$\Delta S$	—	17	45	$^{\circ}e$
Phase Error	$\Delta\phi$	—	12	25	$^{\circ}e$
Cycle Error	$\Delta C$	—	36	60	$^{\circ}e$
Index Pulse Width	$P_0$	65	90	115	$^{\circ}e$

a. Typical values specified at  $V_{CC} = 5.0V$  and  $25^{\circ}C$  and for single ended, unless otherwise stated.

### Encoder Resolution $\leq 2500$ CPR

Parameter	Symbol	Min.	Typ. <sup>a</sup>	Max.	Units
Pulse Width Error	$\Delta P$	—	20	30	$^{\circ}e$
Logic State Width Error	$\Delta S$	—	15	25	$^{\circ}e$
Phase Error	$\Delta\phi$	—	10	15	$^{\circ}e$
Cycle Error	$\Delta C$	—	17	30	$^{\circ}e$
Index Pulse Width	$P_0$	72	90	108	$^{\circ}e$

a. Typical values specified at  $V_{CC} = 5.0V$  and  $25^{\circ}C$  and for single ended, unless otherwise stated.

## Codewheel Base CPR Selection Table

Refer to the AEDT-981x Application Note for codewheel design guidelines.

Encoder Module P/N	Codewheel Base CPR	Encoder Resolution	Optical Radius RoP
AEDT-98XX-B00	500	1000	11.00 mm
AEDT-98XX-J00	512	1024	11.26 mm
AEDT-98XX-L00	625	1250	11.00 mm
AEDT-98XX-T00	500	2000	11.00 mm
AEDT-98XX-U00	512	2048	11.26 mm
AEDT-98XX-W00	625	2500	11.00 mm
AEDT-98XX-N00	500	4000	11.00 mm
AEDT-98XX-R00	512	4096	11.26 mm
AEDT-98XX-Z00	625	5000	11.00 mm

## Electrical Characteristics over Recommended Operating Range

Parameter	Symbol	Min.	Typ. <sup>a</sup>	Max.	Units	Notes
Supply Current	$I_{CC}$	—	20	80	mA	No load
High Level Output Voltage	$V_{OH}$	2.4	—	—	V	$I_{OH} = -5 \text{ mA}$
Low Level Output Voltage	$V_{OL}$	—	—	0.4	V	$I_{OL} = 5 \text{ mA}$
Rise Time	$t_r$	—	10	—	ns	$C_L = 100 \text{ pF}$ at $\pm 5 \text{ mA}$
Fall Time	$t_f$	—	10	—	ns	$C_L = 100 \text{ pF}$ at $\pm 5 \text{ mA}$

a. Typical values specified at  $V_{CC} = 5.0 \text{ V}$ ,  $25^\circ\text{C}$  and nominal sensor position.

## Electrical Interface

The AEDT-918x series encoders output circuitry are designed with high speed and high drivability sink/source output of  $\pm 5 \text{ mA}$  without the need of pull-up resistors. The high drivability offers rail to rail  $V_{OH}$  and  $V_{OL}$ , giving the end customer better noise margin in signal processing; hence, more reliable in industrial applications.

Figure 6: Electrical Interface

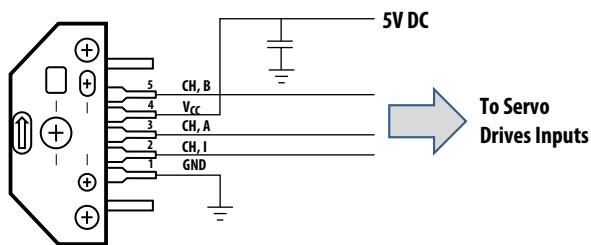



# Connectors

Manufacturer	Part Number
AMP	103686-4
	640442-5
Broadcom	HEDS-8902 (2 ch.) with 4-wire leads
	HEDS-8903 (3 ch.) with 5-wire leads
Molex	2695 series with 2759 series term.

Figure 7: Connectors

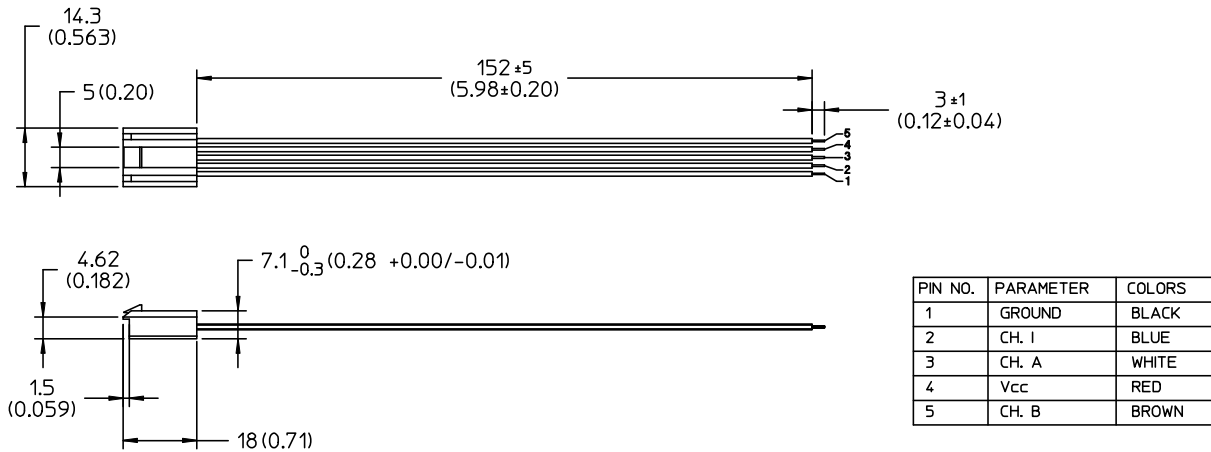

# Ordering Information

Three Channel Encoder Modules

