

## AES2AF-HF Thru. AES2KF-HF

Reverse Voltage: 50 to 800 Volts

Forward Current: 2.0 Amp

RoHS Device

Halogen Free

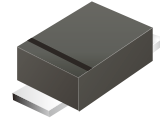

### Features

- For surface mounted applications.
- Low profile package.
- Low forward voltage drop.
- High surge current capability.
- AEC-Q101 Qualified.

### Mechanical data

- Case: SMAF, molded plastic.
- Epoxy: UL flammability classification rating 94V-0.
- Terminals: Solder plated, solderable per MIL-STD-202, method 208.
- Polarity: Color band denoted cathode end.

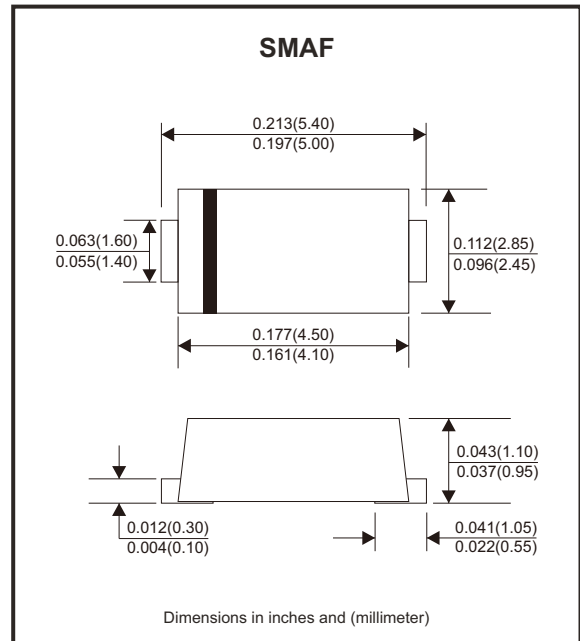

### Circuit Diagram



### Maximum Ratings (at TA=25°C unless otherwise specified)

Parameter	Symbols	AES2AF-HF	AES2BF-HF	AES2CF-HF	AES2DF-HF	AES2EF-HF	AES2GF-HF	AES2HF-HF	AES2JF-HF	AES2KF-HF	Units
Peak repetitive reverse voltage	V <sub>RRM</sub>	50	100	150	200	300	400	500	600	800	V
RMS reverse voltage	V <sub>RMS</sub>	35	70	105	140	210	280	350	420	560	V
DC blocking voltage	V <sub>DC</sub>	50	100	150	200	300	400	500	600	800	V
Max. average forward output current	I <sub>F(AV)</sub>	2									A
Peak forward surge current, 8.3ms single half sine-wave	I <sub>FSM</sub>	50									A
Typical thermal resistance (Note 1)	R <sub>θJA</sub> R <sub>θJC</sub> R <sub>θJL</sub>	78 18 20									°C/W
Operating junction temperature range	T <sub>J</sub>	-55 ~ +150									°C
Storage temperature range	T <sub>STG</sub>	-55 ~ +150									°C

Notes: 1. Device mounted on PCB with 10mm x 20mm x 0.1mm copper pad areas.

## Electrical Characteristics (at $T_A=25^\circ\text{C}$ unless otherwise specified)

Parameter	Symbols	Test Conditions		Typ	Max	Units
Max. instantaneous forward voltage	$V_F$	$I_F=2.0\text{A}$	@ $T_A=25^\circ\text{C}$	AES2AF-HF AES2BF-HF AES2CF-HF AES2DF-HF	0.95	V
				AES2EF-HF AES2GF-HF	1.25	
				AES2HF-HF AES2JF-HF	1.7	
				AES2KF-HF	2.3	
Max. reverse current	$I_R$	Rated $V_R$	@ $T_A=25^\circ\text{C}$	AES2AF-HF~AES2JF-HF	5	$\mu\text{A}$
			@ $T_A=125^\circ\text{C}$	AES2KF-HF	10	
Max. reverse recovery time	$t_{rr}$	$I_F=0.5\text{A}, I_{RM}=1\text{A}, I_{R(REC)}=0.25\text{A}$			35	ns

## Rating and Characteristic Curves (AES2AF-HF Thru. AES2DF-HF)

Fig.1 - Forward Current Derating Curve

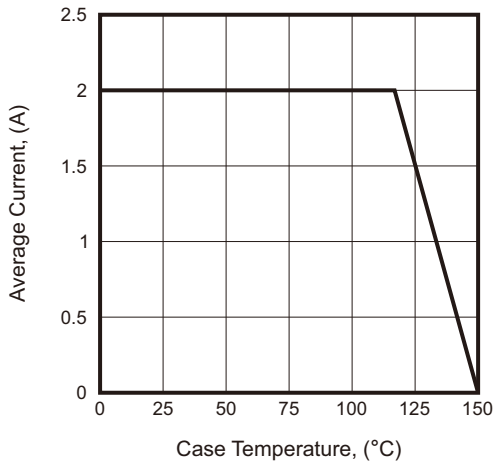

Fig.2 - Surge Current Derating Curve

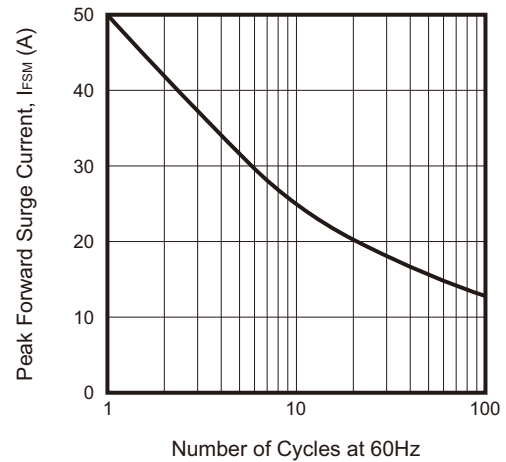

Fig.3 - Typical Forward Voltage Characteristic

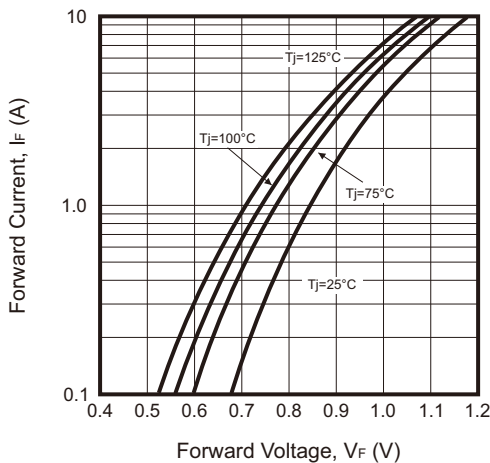
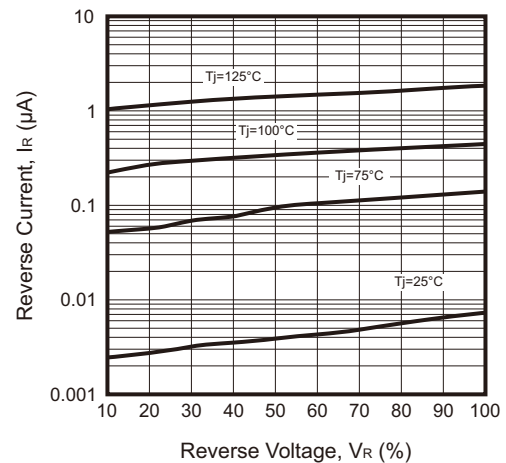

Fig.4 - Typical Reverse Characteristic



Company reserves the right to improve product design, functions and reliability without notice.

## Rating and Characteristic Curves (AES2EF-HF Thru. AES2GF-HF)

Fig.5 - Forward Current Derating Curve

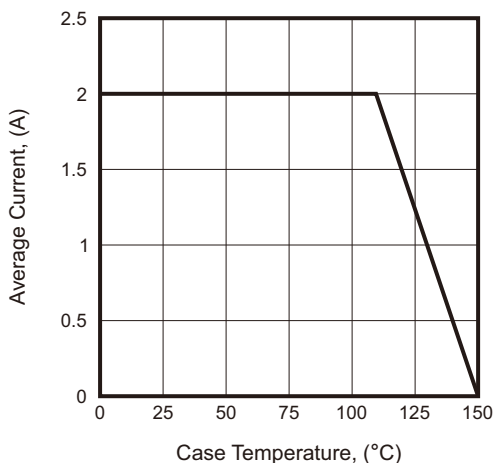

Fig.6 - Surge Current Derating Curve

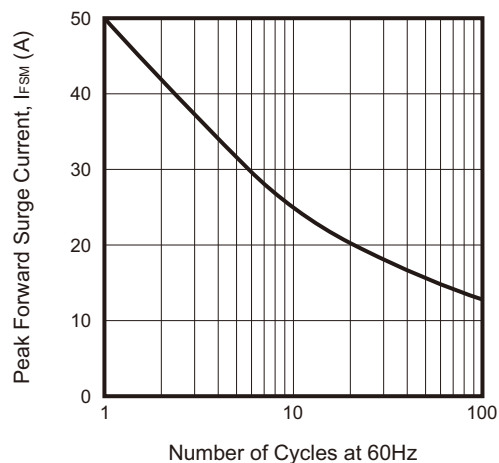

Fig.7 - Typical Forward Voltage Characteristic

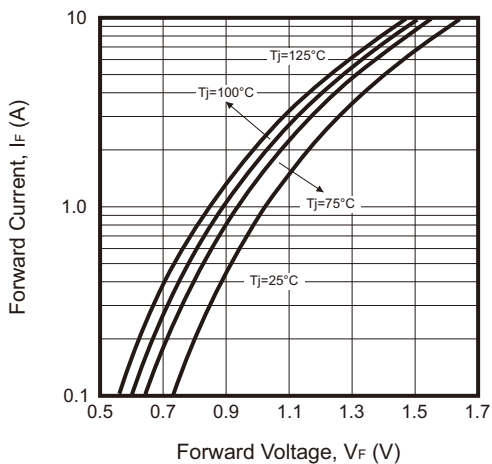
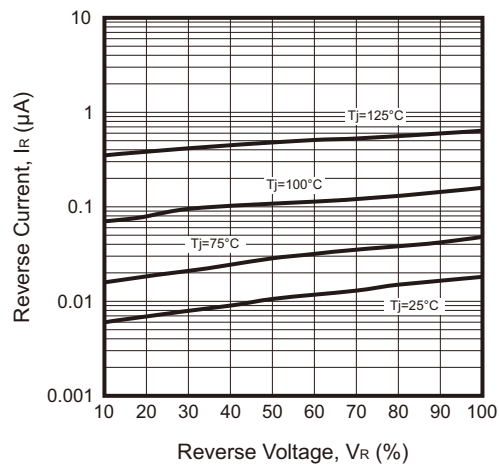

Fig.8 - Typical Reverse Characteristic



## Rating and Characteristic Curves (AES2HF-HF Thru. AES2JF-HF)

Fig.9 - Forward Current Derating Curve

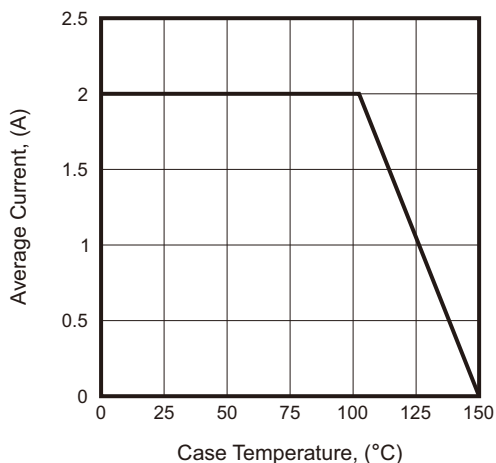

Fig.10 - Surge Current Derating Curve

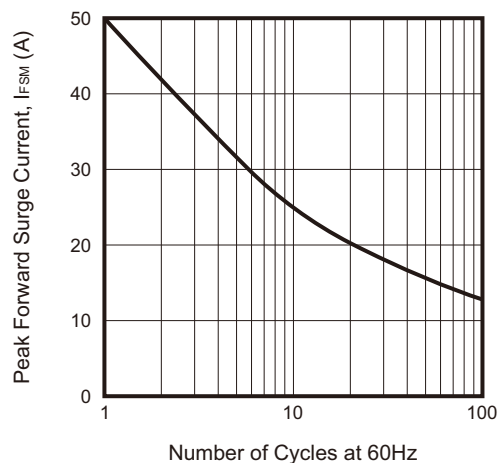

Fig.11 - Typical Forward Voltage Characteristic

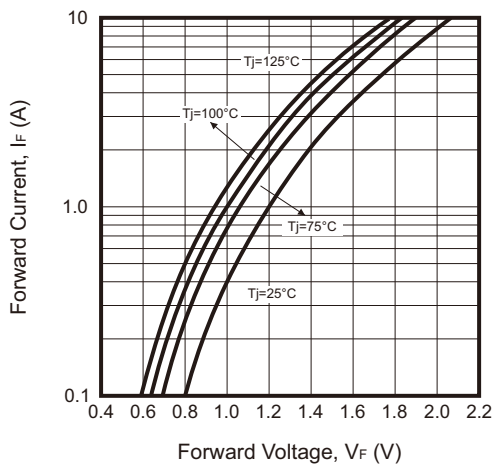
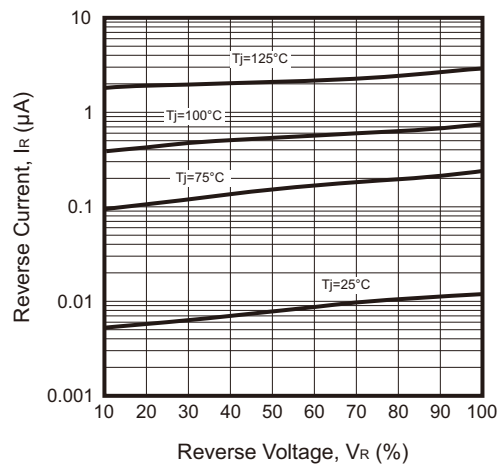

Fig.12 - Typical Reverse Characteristic



## Rating and Characteristic Curves (AES2KF-HF)

Fig.13 - Forward Current Derating Curve

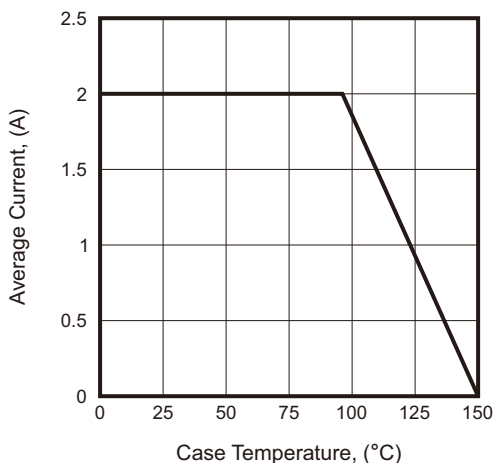

Fig.14 - Surge Current Derating Curve

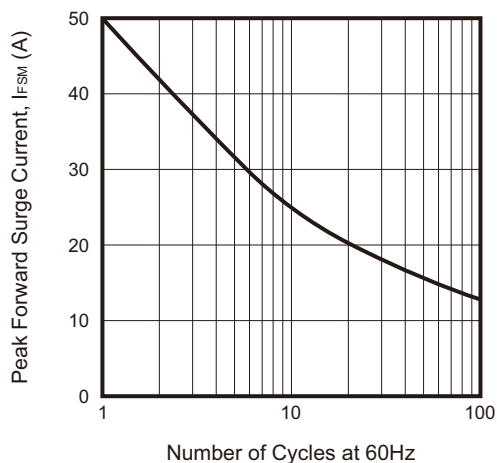

Fig.15 - Typical Forward Voltage Characteristic

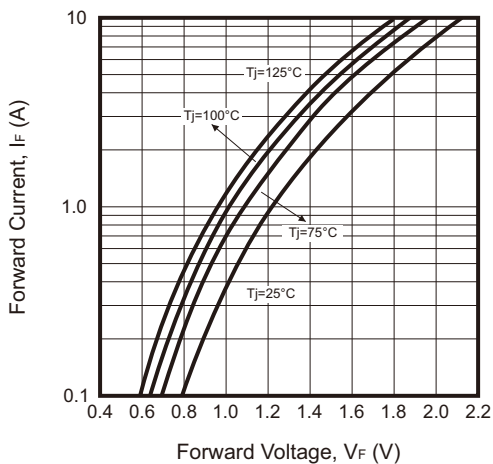
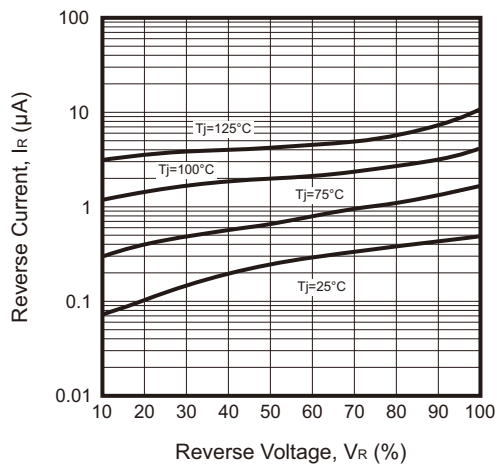
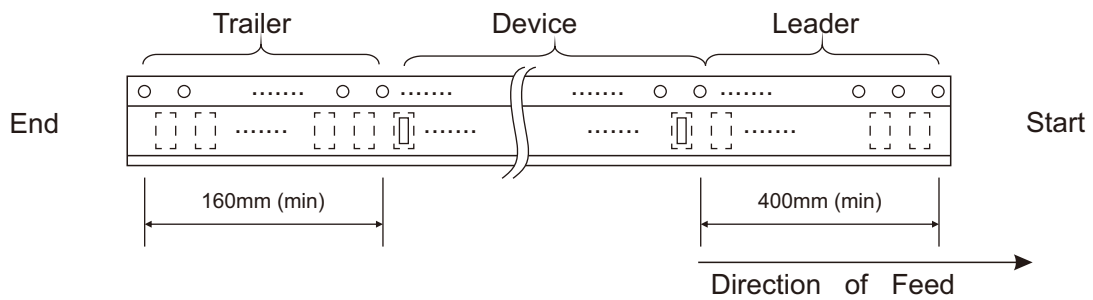
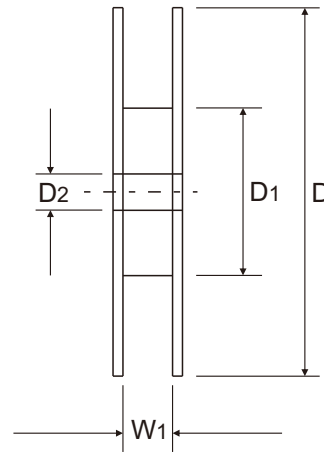
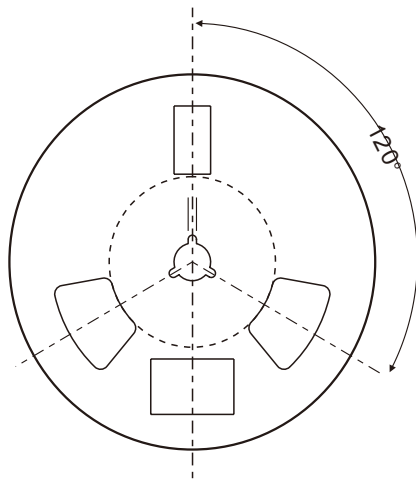
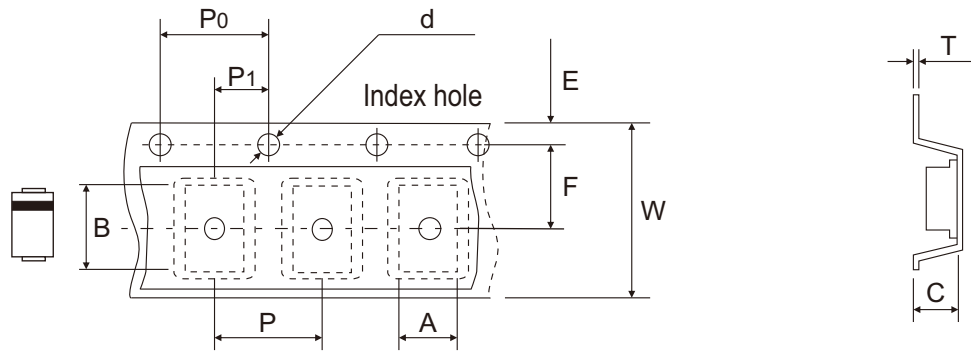

Fig.16 - Typical Reverse Characteristic



## Reel Taping Specification



SMAF	SYMBOL	A	B	C	d	D	D1	D2
	(mm)	2.93 ± 0.10	5.45 ± 0.10	1.10 ± 0.10	1.55 ± 0.10	330 ± 1.00	75.00 ± 1.00	13.50 ± 0.50
	(inch)	0.115 ± 0.004	0.215 ± 0.004	0.043 ± 0.004	0.061 ± 0.004	12.992 ± 0.039	2.953 ± 0.039	0.531 ± 0.020

SMAF	SYMBOL	E	F	P	P0	P1	T	W	W1
	(mm)	1.75 ± 0.10	5.50 ± 0.05	4.00 ± 0.10	4.00 ± 0.10	2.00 ± 0.10	0.23 ± 0.05	12.00 ± 0.10	13.50 ± 1.00
	(inch)	0.069 ± 0.004	0.217 ± 0.002	0.157 ± 0.004	0.157 ± 0.004	0.079 ± 0.004	0.009 ± 0.002	0.472 ± 0.004	0.531 ± 0.039

Company reserves the right to improve product design, functions and reliability without notice.

REV:A