

Field Stop Trench IGBT

50 A, 650 V

AFGHL50T65SQ

Using the novel field stop 4th generation high speed IGBT technology. AFGHL50T65SQ which is AEC Q101 qualified offers the optimum performance for both hard and soft switching topology in automotive application. It is a stand-alone IGBT.

Features

- AEC-Q101 Qualified
- Maximum Junction Temperature: $T_J = 175^\circ\text{C}$
- Positive Temperature Co-efficient for Easy Parallel Operating
- High Current Capability
- Low Saturation Voltage: $V_{CE(Sat)} = 1.6\text{ V (Typ.) @ } I_C = 50\text{ A}$
- 100% of the Parts are Tested for I_{LM} (Note 2)
- Fast Switching
- Tight Parameter Distribution
- RoHS Compliant

Typical Applications

- Automotive HEV-EV Onboard Chargers
- Automotive HEV-EV DC-DC Converters
- Totem Pole Bridgeless PFC
- PTC

MAXIMUM RATINGS

Rating	Symbol	Value	Unit
Collector-to-Emitter Voltage	V_{CES}	650	V
Gate-to-Emitter Voltage Transient Gate-to-Emitter Voltage	V_{GES}	± 20 ± 30	V
Collector Current (Note 1)	I_C	80 50	A
@ $T_C = 25^\circ\text{C}$ @ $T_C = 100^\circ\text{C}$			
Pulsed Collector Current (Note 2)	I_{LM}	200	A
Pulsed Collector Current (Note 3)	I_{CM}	200	A
Maximum Power Dissipation	P_D	268 134	W
@ $T_C = 25^\circ\text{C}$ @ $T_C = 100^\circ\text{C}$			
Operating Junction / Storage Temperature Range	T_J, T_{STG}	-55 to +175	$^\circ\text{C}$
Maximum Lead Temp. for Soldering Purposes, 1/8" from case for 5 seconds	T_L	300	$^\circ\text{C}$

Stresses exceeding those listed in the Maximum Ratings table may damage the device. If any of these limits are exceeded, device functionality should not be assumed, damage may occur and reliability may be affected.

1. Value limit by bond wire
2. $V_{CC} = 400\text{ V}$, $V_{GE} = 15\text{ V}$, $I_C = 200\text{ A}$, $R_G = 15\ \Omega$, Inductive Load
3. Repetitive Rating: pulse width limited by max. Junction temperature



ON Semiconductor®

www.onsemi.com

50 A, 650 V
 $V_{CESat} = 1.6\text{ V}$

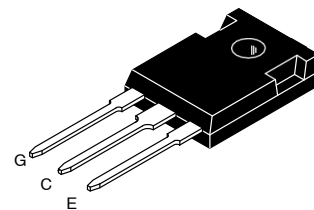
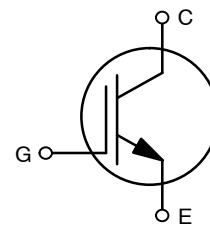

TO-247-3L
CASE 340CX

MARKING DIAGRAM



&Z = Assembly Plant Code
 &3 = 3-Digit Date Code
 &K = 2-Digit Lot Traceability Code
 AFGHL50T65SQ = Specific Device Code

ORDERING INFORMATION

Device	Package	Shipping
AFGHL50T65SQ	TO-247-3L	30 Units / Rail

AFGHL50T65SQ

THERMAL CHARACTERISTICS

Rating	Symbol	Value	Unit
Thermal resistance junction-to-case, for IGBT	$R_{\theta JC}$	0.56	°C/W
Thermal resistance junction-to-ambient	$R_{\theta JA}$	40	°C/W

ELECTRICAL CHARACTERISTICS ($T_J = 25^\circ\text{C}$ unless otherwise noted)

Parameter	Test Conditions	Symbol	Min	Typ	Max	Unit
-----------	-----------------	--------	-----	-----	-----	------

OFF CHARACTERISTICS

Collector-emitter breakdown voltage, gate-emitter short-circuited	$V_{GE} = 0\text{ V}, I_C = 1\text{ mA}$	BV_{CES}	650	-	-	V
Temperature Coefficient of Breakdown Voltage	$V_{GE} = 0\text{ V}, I_C = 1\text{ mA}$	$\frac{\Delta BV_{CES}}{\Delta T_J}$	-	0.6	-	V/°C
Collector-emitter cut-off current, gate-emitter short-circuited	$V_{GE} = 0\text{ V}, V_{CE} = 650\text{ V}$	I_{CES}	-	-	250	μA
Gate leakage current, collector-emitter short-circuited	$V_{GE} = 20\text{ V}, V_{CE} = 0\text{ V}$	I_{GES}	-	-	±400	nA

ON CHARACTERISTICS

Gate-emitter threshold voltage	$V_{GE} = V_{CE}, I_C = 50\text{ mA}$	$V_{GE(th)}$	3.4	4.9	6.4	V
Collector-emitter saturation voltage	$V_{GE} = 15\text{ V}, I_C = 50\text{ A}$ $V_{GE} = 15\text{ V}, I_C = 50\text{ A}, T_J = 175^\circ\text{C}$	$V_{CE(sat)}$	-	1.6	2.1	V
			-	1.95	-	

DYNAMIC CHARACTERISTICS

Input capacitance	$V_{CE} = 30\text{ V}, V_{GE} = 0\text{ V}, f = 1\text{ MHz}$	C_{ies}	-	3209	-	pF
Output capacitance		C_{oes}	-	42	-	
Reverse transfer capacitance		C_{res}	-	12	-	
Gate charge total	$V_{CE} = 400\text{ V}, I_C = 50\text{ A}, V_{GE} = 15\text{ V}$	Q_g	-	99	-	nC
Gate-to-emitter charge		Q_{ge}	-	17	-	
Gate-to-collector charge		Q_{gc}	-	23	-	

SWITCHING CHARACTERISTICS, INDUCTIVE LOAD

Turn-on delay time	$T_C = 25^\circ\text{C}, V_{CC} = 400\text{ V}, I_C = 25\text{ A}, R_G = 4.7\ \Omega, V_{GE} = 15\text{ V},$ Inductive Load, FWD: AFGHL50T65SQD	$t_{d(on)}$	-	19	-	ns
Rise time		t_r	-	11	-	
Turn-off delay time		$t_{d(off)}$	-	87	-	
Fall time		t_f	-	5	-	
Turn-on switching loss		E_{on}	-	0.35	-	mJ
Turn-off switching loss		E_{off}	-	0.12	-	
Total switching loss		E_{ts}	-	0.47	-	
Turn-on delay time	$T_C = 25^\circ\text{C}, V_{CC} = 400\text{ V}, I_C = 50\text{ A}, R_G = 4.7\ \Omega, V_{GE} = 15\text{ V},$ Inductive Load, FWD: AFGHL50T65SQD	$t_{d(on)}$	-	20	-	ns
Rise time		t_r	-	28	-	
Turn-off delay time		$t_{d(off)}$	-	81	-	
Fall time		t_f	-	36	-	
Turn-on switching loss		E_{on}	-	0.95	-	mJ
Turn-off switching loss		E_{off}	-	0.46	-	
Total switching loss		E_{ts}	-	1.41	-	

AFGHL50T65SQ

ELECTRICAL CHARACTERISTICS ($T_J = 25^\circ\text{C}$ unless otherwise noted) (Continued)

Parameter	Test Conditions	Symbol	Min	Typ	Max	Unit
SWITCHING CHARACTERISTICS, INDUCTIVE LOAD						
Turn-on delay time	$T_J = 175^\circ\text{C}$, $V_{CC} = 400\text{ V}$, $I_C = 25\text{ A}$, $R_G = 4.7\ \Omega$, $V_{GE} = 15\text{ V}$, Inductive Load, FWD: AFGHL50T65SQD	$t_{d(on)}$	-	18	-	ns
Rise time		t_r	-	14	-	
Turn-off delay time		$t_{d(off)}$	-	99	-	
Fall time		t_f	-	7	-	
Turn-on switching loss		E_{on}	-	0.66	-	mJ
Turn-off switching loss		E_{off}	-	0.3	-	
Total switching loss		E_{ts}	-	0.96	-	
Turn-on delay time	$T_J = 175^\circ\text{C}$, $V_{CC} = 400\text{ V}$, $I_C = 50\text{ A}$, $R_G = 4.7\ \Omega$, $V_{GE} = 15\text{ V}$, Inductive Load, FWD: AFGHL50T65SQD	$t_{d(on)}$	-	20	-	ns
Rise time		t_r	-	29	-	
Turn-off delay time		$t_{d(off)}$	-	88	-	
Fall time		t_f	-	46	-	
Turn-on switching loss		E_{on}	-	1.42	-	mJ
Turn-off switching loss		E_{off}	-	0.65	-	
Total switching loss		E_{ts}	-	2.07	-	

Product parametric performance is indicated in the Electrical Characteristics for the listed test conditions, unless otherwise noted. Product performance may not be indicated by the Electrical Characteristics if operated under different conditions.

AFGHL50T65SQ

TYPICAL CHARACTERISTICS

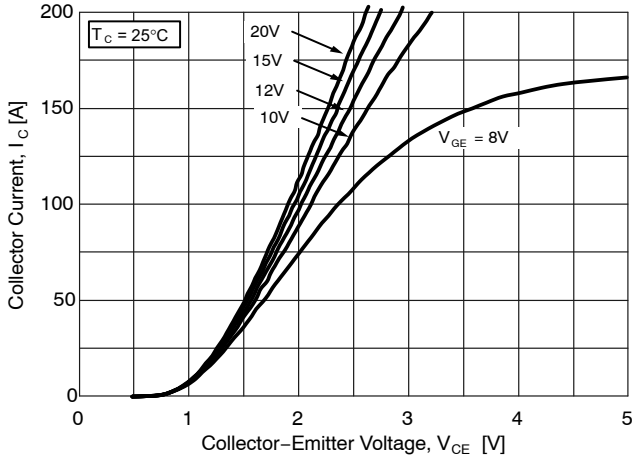

Figure 1. Typical Output Characteristics

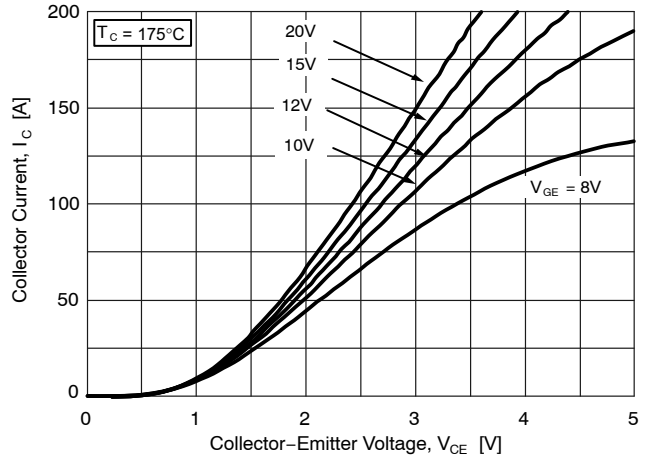

Figure 2. Typical Output Characteristics

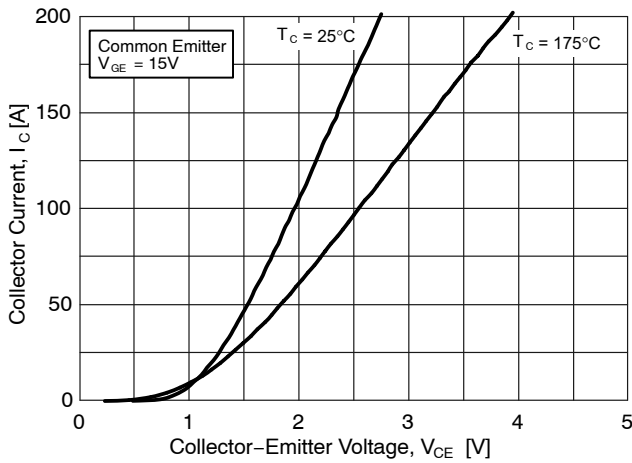

Figure 3. Typical Saturation Voltage

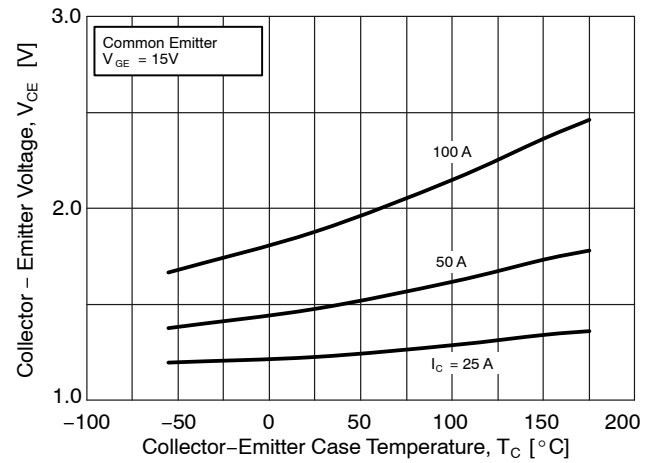

Figure 4. Saturation Voltage vs. Case Temperature

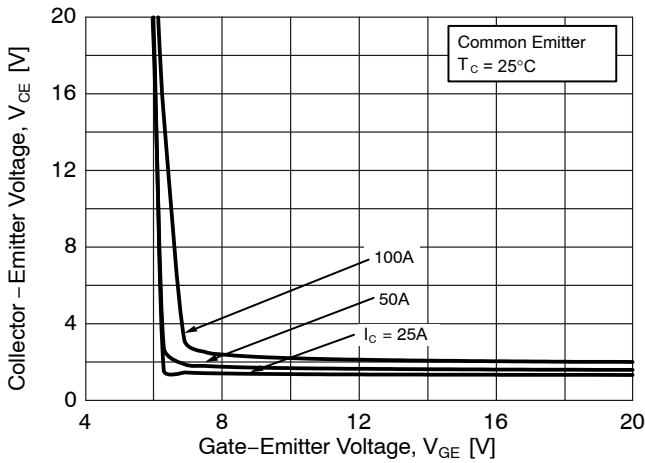

Figure 5. Saturation Voltage vs. V_{GE}

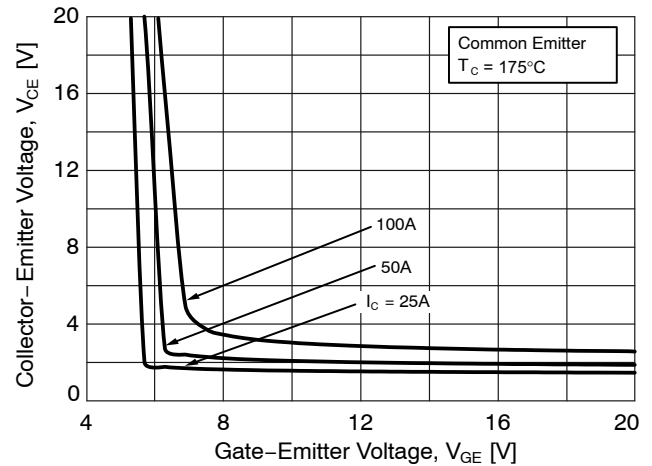

Figure 6. Saturation Voltage vs. V_{GE}

AFGHL50T65SQ

TYPICAL CHARACTERISTICS

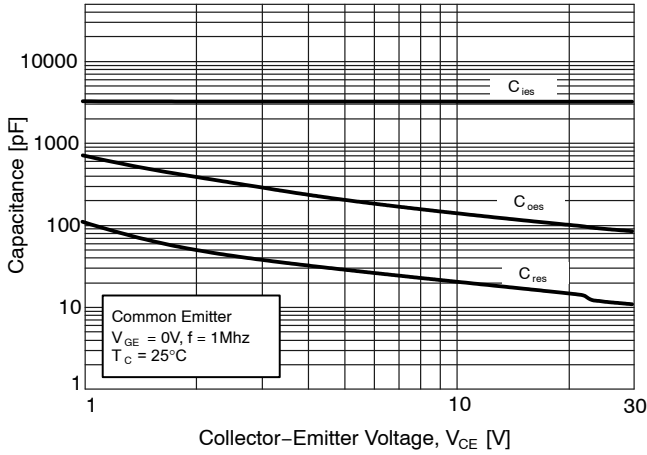

Figure 7. Capacitance Characteristics

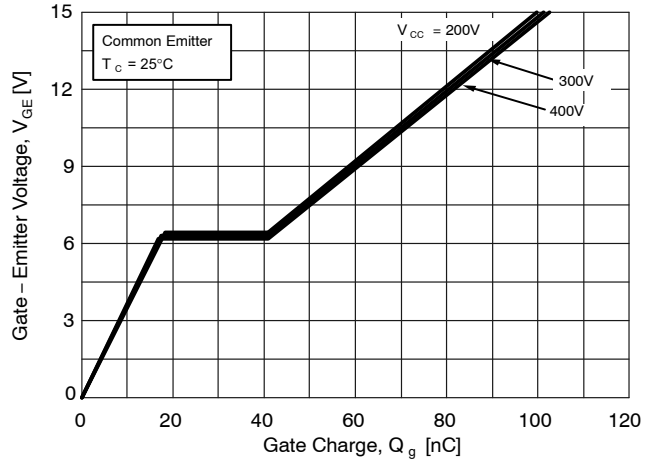

Figure 8. Gate Charge

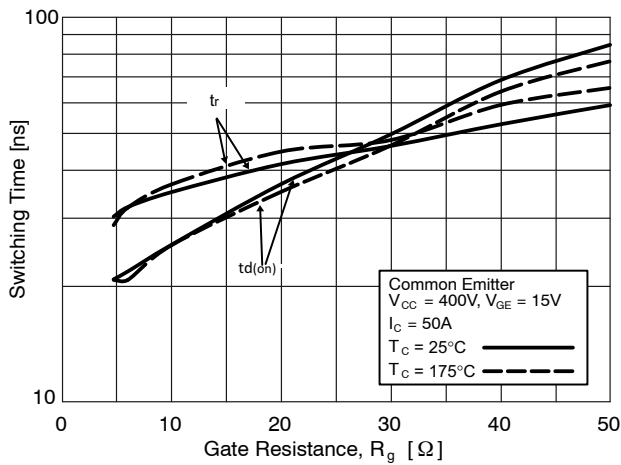

Figure 9. Turn-On Characteristics vs. Gate Resistance

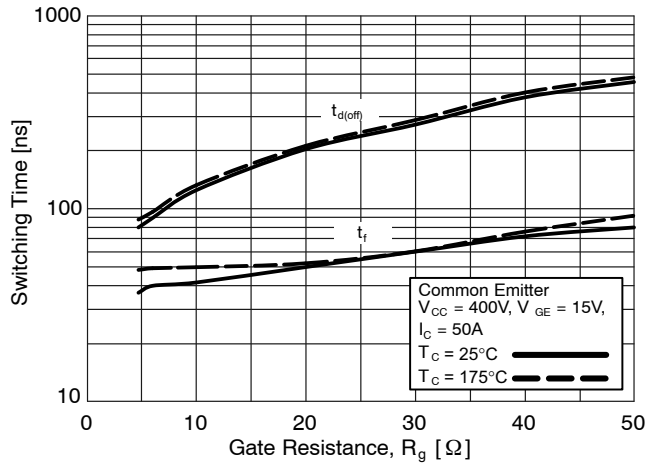

Figure 10. Turn-Off Characteristics vs. Gate Resistance

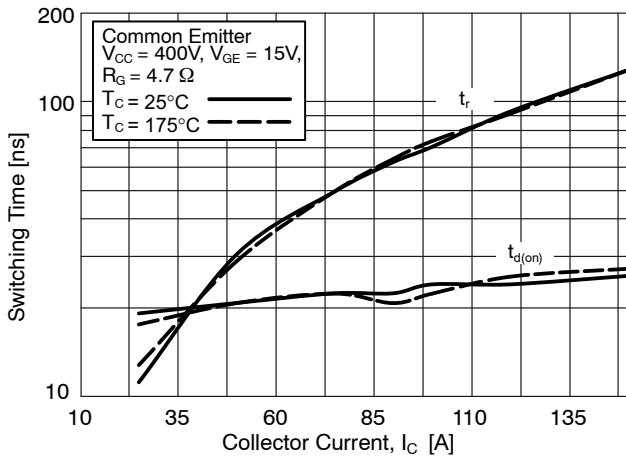

Figure 11. Turn-On Characteristics vs. Collector Current

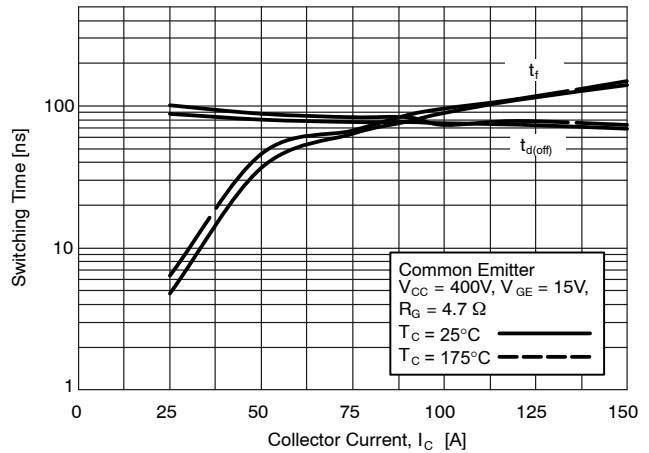

Figure 12. Turn-Off Characteristics vs. Collector Current

AFGHL50T65SQ

TYPICAL CHARACTERISTICS

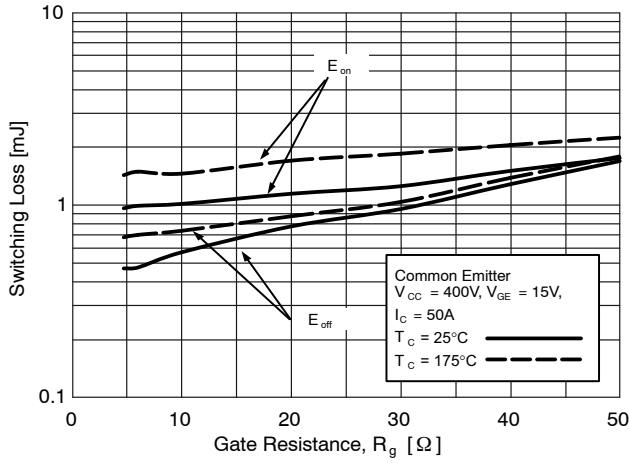

Figure 13. Switching Loss vs. Gate Resistance

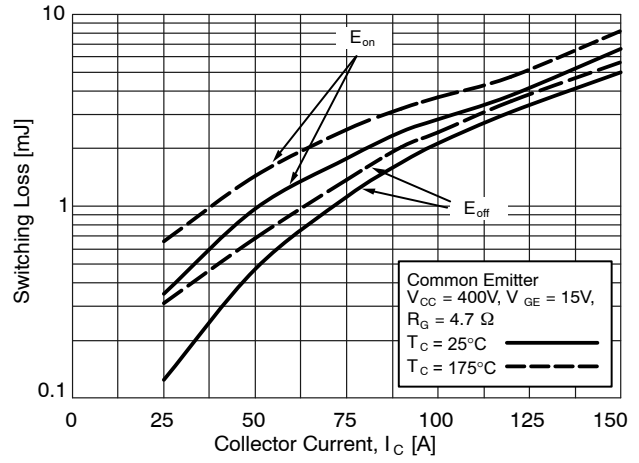

Figure 14. Switching Loss vs. Collector Current

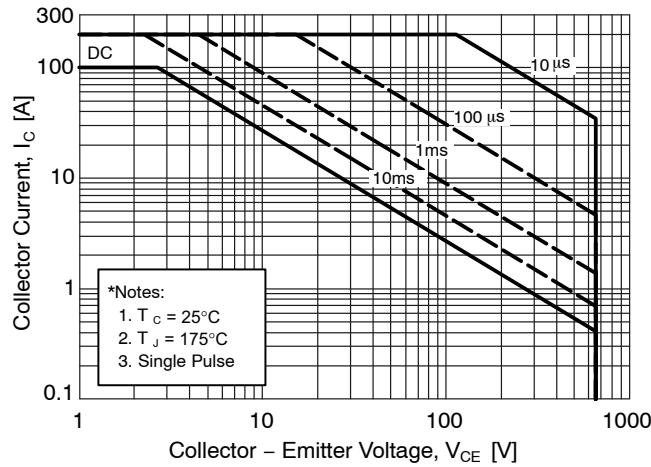

Figure 15. SOA Characteristics

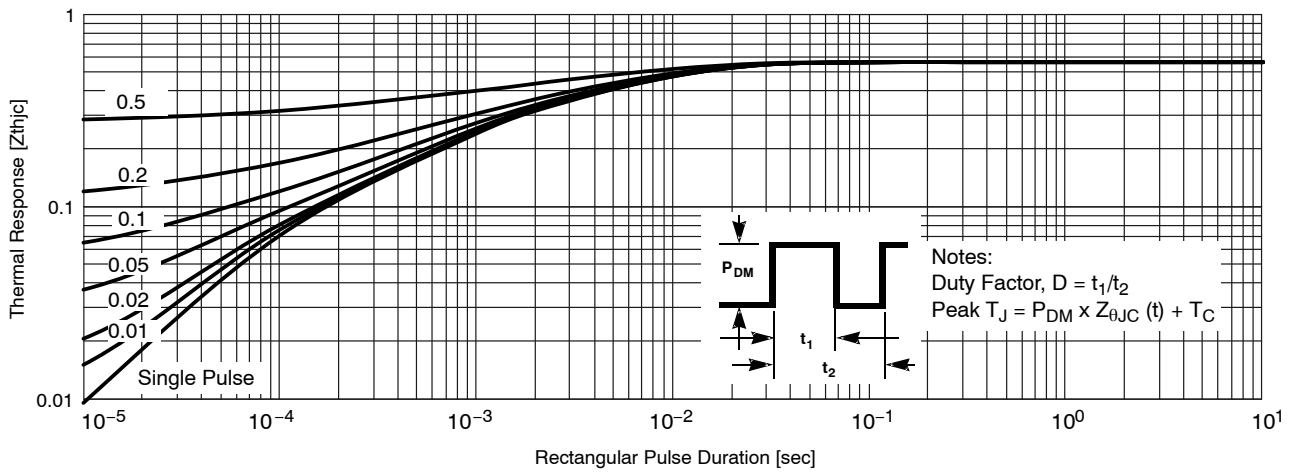

Figure 16. transient Thermal Impedance of IGBT

MECHANICAL CASE OUTLINE

PACKAGE DIMENSIONS

ON Semiconductor®



TO-247-3LD
CASE 340CX
ISSUE A

DATE 06 JUL 2020

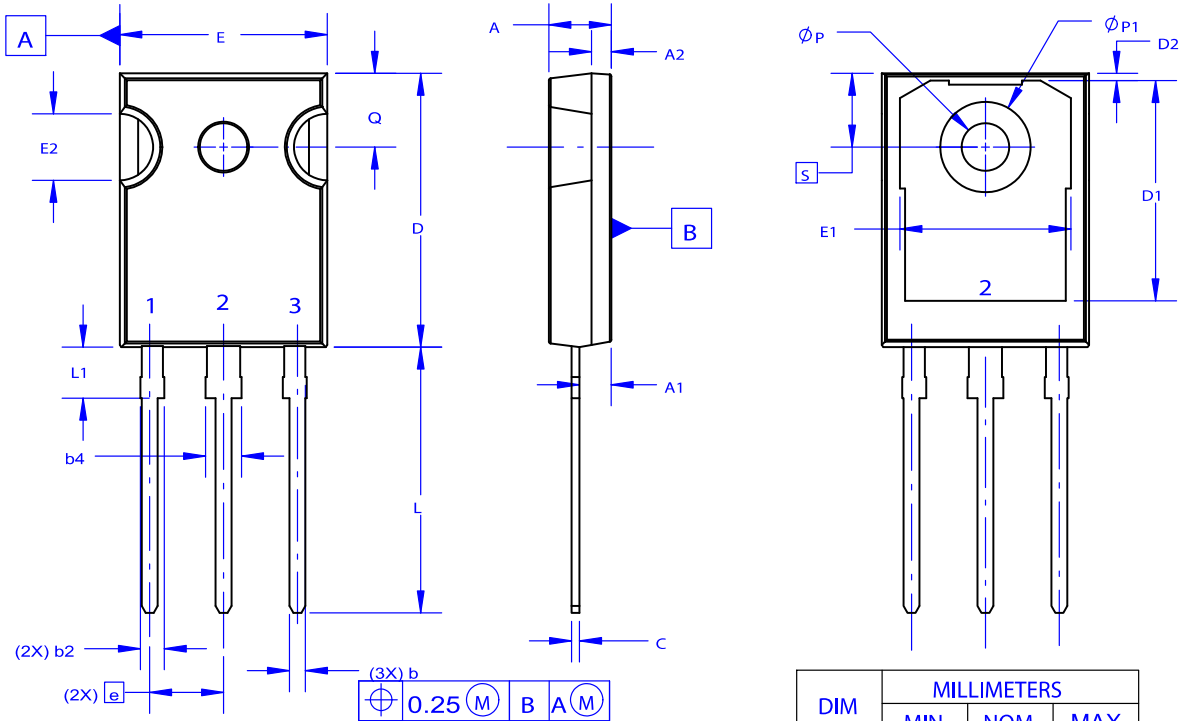
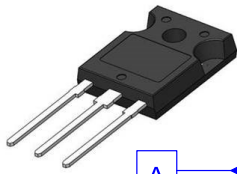

NOTES: UNLESS OTHERWISE SPECIFIED.

- A. DIMENSIONS ARE EXCLUSIVE OF BURRS, MOLD FLASH, AND TIE BAR EXTRUSIONS.
- B. ALL DIMENSIONS ARE IN MILLIMETERS.
- C. DRAWING CONFORMS TO ASME Y14.5 - 2009.
- D. DIMENSION A1 TO BE MEASURED IN THE REGION DEFINED BY L1.
- E. LEAD FINISH IS UNCONTROLLED IN THE REGION DEFINED BY L1.

GENERIC MARKING DIAGRAM*



- XXXXX = Specific Device Code
- A = Assembly Location
- Y = Year
- WW = Work Week
- G = Pb-Free Package

*This information is generic. Please refer to device data sheet for actual part marking. Pb-Free indicator, "G" or microdot "▪", may or may not be present. Some products may not follow the Generic Marking.

DIM	MILLIMETERS		
	MIN	NOM	MAX
A	4.58	4.70	4.82
A1	2.20	2.40	2.60
A2	1.40	1.50	1.60
D	20.32	20.57	20.82
E	15.37	15.62	15.87
E2	4.96	5.08	5.20
e	~	5.56	~
L	19.75	20.00	20.25
L1	3.69	3.81	3.93
ØP	3.51	3.58	3.65
Q	5.34	5.46	5.58
S	5.34	5.46	5.58
b	1.17	1.26	1.35
b2	1.53	1.65	1.77
b4	2.42	2.54	2.66
c	0.51	0.61	0.71
D1	13.08	~	~
D2	0.51	0.93	1.35
E1	12.81	~	~
ØP1	6.60	6.80	7.00

DOCUMENT NUMBER:	98AON93302G	Electronic versions are uncontrolled except when accessed directly from the Document Repository. Printed versions are uncontrolled except when stamped "CONTROLLED COPY" in red.
DESCRIPTION:	TO-247-3LD	PAGE 1 OF 1

ON Semiconductor and are trademarks of Semiconductor Components Industries, LLC dba ON Semiconductor or its subsidiaries in the United States and/or other countries. ON Semiconductor reserves the right to make changes without further notice to any products herein. ON Semiconductor makes no warranty, representation or guarantee regarding the suitability of its products for any particular purpose, nor does ON Semiconductor assume any liability arising out of the application or use of any product or circuit, and specifically disclaims any and all liability, including without limitation special, consequential or incidental damages. ON Semiconductor does not convey any license under its patent rights nor the rights of others.