

# RF Power LDMOS Transistors

## N-Channel Enhancement-Mode Lateral MOSFETs

These 100 W symmetrical Doherty RF power LDMOS transistors are designed for cellular base station applications covering the frequency range of 720 to 960 MHz.

- Typical Doherty Single-Carrier W-CDMA Performance:  $V_{DD} = 48$  Vdc,  $I_{DQA} = 860$  mA,  $V_{GSB} = 0.9$  Vdc,  $P_{out} = 100$  W Avg., Input Signal PAR = 9.9 dB @ 0.01% Probability on CCDF.

| Frequency | $G_{ps}$ (dB) | $\eta_D$ (%) | Output PAR (dB) | ACPR (dBc) |
|-----------|---------------|--------------|-----------------|------------|
| 920 MHz   | 19.5          | 48.5         | 7.2             | -29.2      |
| 940 MHz   | 19.5          | 49.5         | 7.1             | -32.0      |
| 960 MHz   | 19.2          | 48.0         | 7.0             | -35.7      |

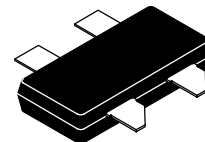
### Features

- Production Tested in a Symmetrical Doherty Configuration
- Greater Negative Gate-Source Voltage Range for Improved Class C Operation
- Designed for Digital Predistortion Error Correction Systems
- In Tape and Reel. R3 Suffix = 250 Units, 32 mm Tape Width, 13-inch Reel.

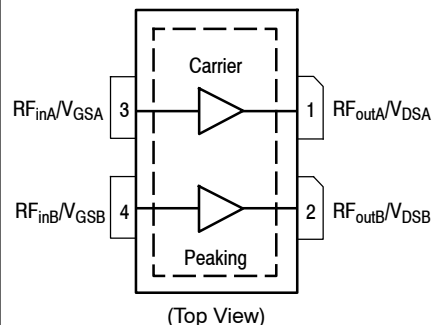
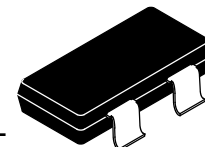
**AFV09P350-04NR3**  
**AFV09P350-04GNR3**

**720-960 MHz, 100 W AVG., 48 V**  
**AIRFAST RF POWER LDMOS**  
**TRANSISTORS**

**OM-780-4L**  
**PLASTIC**  
**AFV09P350-04NR3**



**OM-780G-4L**  
**PLASTIC**  
**AFV09P350-04GNR3**



Note: Exposed backside of the package is the source terminal for the transistors.

**Figure 1. Pin Connections**

**Table 1. Maximum Ratings**

| Rating  | Symbol    | Value       | Unit |
|---|-----------|-------------|------|
| Drain-Source Voltage                                  | $V_{DSS}$ | -0.5, +105  | Vdc  |
| Gate-Source Voltage                                   | $V_{GS}$  | -6.0, +10   | Vdc  |
| Operating Voltage                                     | $V_{DD}$  | 55, +0      | Vdc  |
| Storage Temperature Range                             | $T_{stg}$ | -65 to +150 | °C   |
| Case Operating Temperature Range                      | $T_C$     | -40 to +150 | °C   |
| Operating Junction Temperature Range <sup>(1,2)</sup> | $T_J$     | -40 to +225 | °C   |

**Table 2. Thermal Characteristics**

| Characteristic  | Symbol          | Value (2,3) | Unit |
|---|-----------------|-------------|------|
| Thermal Resistance, Junction to Case<br>Case Temperature 86°C, 102 W W-CDMA, 48 Vdc, $I_{DQA} = 860$ mA, $V_{GSB} = 0.9$ Vdc, 940 MHz | $R_{\theta JC}$ | 0.45        | °C/W |

**Table 3. ESD Protection Characteristics**

| Test Methodology                      | Class |
|---------------------------------------|-------|
| Human Body Model (per JESD22-A114)    | 1C    |
| Machine Model (per EIA/JESD22-A115)   | A     |
| Charge Device Model (per JESD22-C101) | IV    |

**Table 4. Moisture Sensitivity Level**

| Test Methodology                     | Rating | Package Peak Temperature | Unit |
|--------------------------------------|--------|--------------------------|------|
| Per JESD22-A113, IPC/JEDEC J-STD-020 | 3      | 260                      | °C   |

**Table 5. Electrical Characteristics** ( $T_A = 25^\circ\text{C}$  unless otherwise noted)

| Characteristic | Symbol | Min | Typ | Max | Unit |
|----------------|--------|-----|-----|-----|------|
|----------------|--------|-----|-----|-----|------|

**Off Characteristics<sup>(4)</sup>**

|  |           |   |   |    |                 |
|--|-----------|---|---|----|-----------------|
| Zero Gate Voltage Drain Leakage Current<br>( $V_{DS} = 105$ Vdc, $V_{GS} = 0$ Vdc) | $I_{DSS}$ | — | — | 10 | $\mu\text{Adc}$ |
| Zero Gate Voltage Drain Leakage Current<br>( $V_{DS} = 48$ Vdc, $V_{GS} = 0$ Vdc)  | $I_{DSS}$ | — | — | 1  | $\mu\text{Adc}$ |
| Gate-Source Leakage Current<br>( $V_{GS} = 5$ Vdc, $V_{DS} = 0$ Vdc)               | $I_{GSS}$ | — | — | 1  | $\mu\text{Adc}$ |

**On Characteristics<sup>(4)</sup>**

|  |              |     |      |     |     |
|--|--------------|-----|------|-----|-----|
| Gate Threshold Voltage<br>( $V_{DS} = 10$ Vdc, $I_D = 460$ $\mu\text{Adc}$ )                     | $V_{GS(th)}$ | 1.3 | 1.8  | 2.3 | Vdc |
| Gate Quiescent Voltage<br>( $V_{DD} = 48$ Vdc, $I_{DA} = 860$ mAdc, Measured in Functional Test) | $V_{GS(Q)}$  | 2.0 | 2.5  | 3.0 | Vdc |
| Drain-Source On-Voltage<br>( $V_{GS} = 10$ Vdc, $I_D = 1.3$ Adc)                                 | $V_{DS(on)}$ | 0.1 | 0.21 | 0.3 | Vdc |

1. Continuous use at maximum temperature will affect MTTF.
2. MTTF calculator available at <http://www.freescale.com/rf>. Select Software & Tools/Development Tools/Calculators to access MTTF calculators by product.
3. Refer to AN1955, *Thermal Measurement Methodology of RF Power Amplifiers*. Go to <http://www.freescale.com/rf>. Select Documentation/Application Notes - AN1955.
4. Each side of device measured separately.

(continued)

**Table 5. Electrical Characteristics** ( $T_A = 25^\circ\text{C}$  unless otherwise noted) (continued)

| Characteristic  | Symbol   | Min  | Typ   | Max   | Unit |
|---|----------|------|-------|-------|------|
| <b>Functional Tests</b> (1,2,3) (In Freescale Doherty Test Fixture, 50 ohm system) $V_{DD} = 48\text{ Vdc}$ , $I_{DQA} = 860\text{ mA}$ , $V_{GSB} = 0.9\text{ Vdc}$ , $P_{out} = 100\text{ W Avg.}$ , $f = 920\text{ MHz}$ , Single-Carrier W-CDMA, IQ Magnitude Clipping, Input Signal PAR = 9.9 dB @ 0.01% Probability on CCDF. ACPR measured in 3.84 MHz Channel Bandwidth @ $\pm 5\text{ MHz}$ Offset. |          |      |       |       |      |
| Power Gain  | $G_{ps}$ | 18.5 | 19.5  | 21.5  | dB   |
| Drain Efficiency  | $\eta_D$ | 45.0 | 48.5  | —     | %    |
| Output Peak-to-Average Ratio @ 0.01% Probability on CCDF  | PAR      | 6.6  | 7.2   | —     | dB   |
| Adjacent Channel Power Ratio  | ACPR     | —    | -29.2 | -27.0 | dBc  |

**Load Mismatch** (In Freescale Test Fixture, 50 ohm system)  $I_{DQA} = 860\text{ mA}$ ,  $V_{GSB} = 0.9\text{ Vdc}$ ,  $f = 940\text{ MHz}$ 

|  |                       |
|--|-----------------------|
| VSWR 10:1 at 52 Vdc, 500 W Pulsed Output Power<br>(3 dB Input Overdrive from 200 W Pulsed Rated Power) | No Device Degradation |
|--|-----------------------|

**Typical Performances** (2) (In Freescale Doherty Test Fixture, 50 ohm system)  $V_{DD} = 48\text{ Vdc}$ ,  $I_{DQA} = 860\text{ mA}$ ,  $V_{GSB} = 0.9\text{ Vdc}$ , 920-960 MHz Bandwidth

|  |               |   |        |   |       |
|--|---------------|---|--------|---|-------|
| $P_{out}$ @ 1 dB Compression Point, CW   | P1dB          | — | 200    | — | W     |
| $P_{out}$ @ 3 dB Compression Point (4)   | P3dB          | — | 500    | — | W     |
| AM/PM<br>(Maximum value measured at the P3dB compression point across the 920-960 MHz frequency range) | $\Phi$        | — | -21    | — | °     |
| VBW Resonance Point<br>(IMD Third Order Intermodulation Inflection Point)                              | $VBW_{res}$   | — | 43     | — | MHz   |
| Gain Flatness in 40 MHz Bandwidth @ $P_{out} = 100\text{ W Avg.}$                                      | $G_F$         | — | 0.3    | — | dB    |
| Gain Variation over Temperature<br>(-30°C to +85°C)  | $\Delta G$    | — | 0.01   | — | dB/°C |
| Output Power Variation over Temperature<br>(-30°C to +85°C)  | $\Delta P1dB$ | — | 0.0075 | — | dB/°C |

1. Part internally input matched.
2. Measurement made with device in a symmetrical Doherty configuration.
3. Measurement made with device in straight lead configuration before any lead forming operation is applied.
4. P3dB =  $P_{avg} + 7.0\text{ dB}$  where  $P_{avg}$  is the average output power measured using an unclipped W-CDMA single-carrier input signal where output PAR is compressed to 7.0 dB @ 0.01% probability on CCDF.

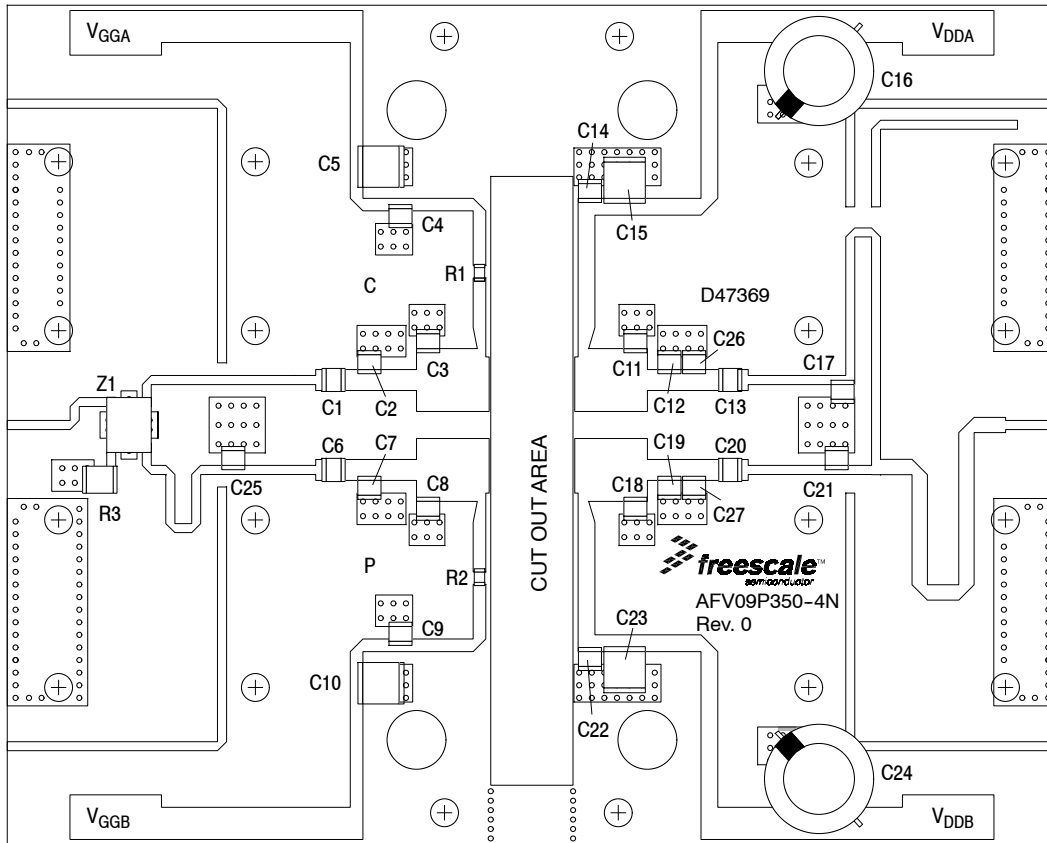
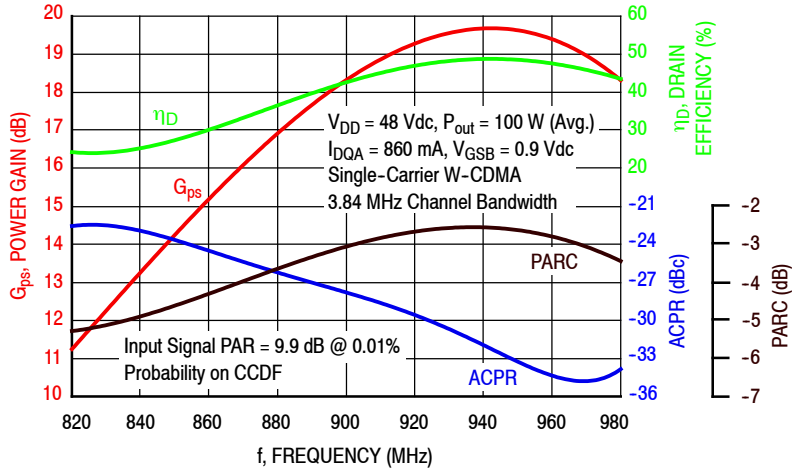


Figure 2. AFV09P350-04NR3 Test Circuit Component Layout

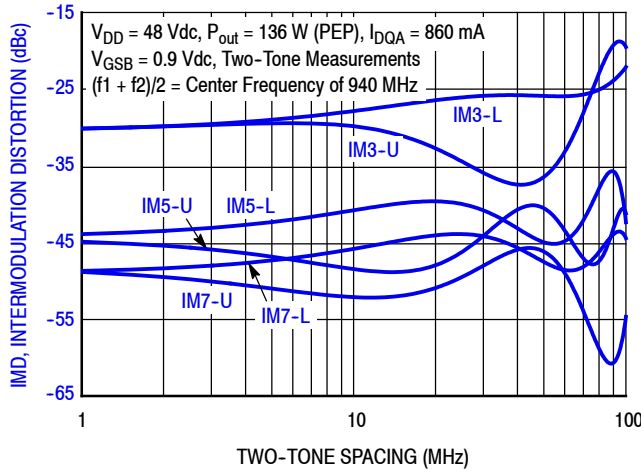
Table 6. AFV09P350-04NR3 Test Circuit Component Designations and Values

| Part             | Description                                 | Part Number           | Manufacturer |
|------------------|---|-----------------------|--------------|
| C1, C6, C13, C20 | 33 pF Chip Capacitors                       | ATC100B330JT500XT     | ATC          |
| C2, C7, C17, C21 | 4.3 pF Chip Capacitors                      | ATC100B4R3CT500XT     | ATC          |
| C3, C8           | 6.8 pF Chip Capacitors                      | ATC100B6R8CT500XT     | ATC          |
| C4, C9, C14, C22 | 47 pF Chip Capacitors                       | ATC100B470JT500XT     | ATC          |
| C5, C10          | 2.2 $\mu$ F Chip Capacitors                 | C3225X7R1H225K250AB   | TDK          |
| C11, C18         | 12 pF Chip Capacitors                       | ATC100B120JT500XT     | ATC          |
| C12, C19         | 8.2 pF Chip Capacitors                      | ATC100B8R2CT500XT     | ATC          |
| C15, C23         | 10 $\mu$ F Chip Capacitors                  | C5750X7S2A106M230KB   | TDK          |
| C16, C24         | 220 $\mu$ F, 100 V Electrolytic Capacitors  | MCGPR100V227M16X26-RH | Multicomp    |
| C25              | 0.5 pF Chip Capacitor                       | ATC100B0R5BT500XT     | ATC          |
| C26              | 0.3 pF Chip Capacitor                       | ATC100B0R3BT500XT     | ATC          |
| C27              | 0.8 pF Chip Capacitor                       | ATC100B0R8BT500XT     | ATC          |
| R1, R2           | 1.5 $\Omega$ , 1/4 W Chip Resistors         | RC1206FR-071R5L       | Yageo        |
| R3               | 50 $\Omega$ , 30 W Termination              | RFP-375375N6Z50-2     | Anaren       |
| Z1               | 800-1000 MHz Band, 90°, 3 dB Hybrid Coupler | X3C09P1-03S           | Anaren       |
| PCB              | Rogers RO4350B, 0.020", $\epsilon_r = 3.66$ | D47369                | MTL          |

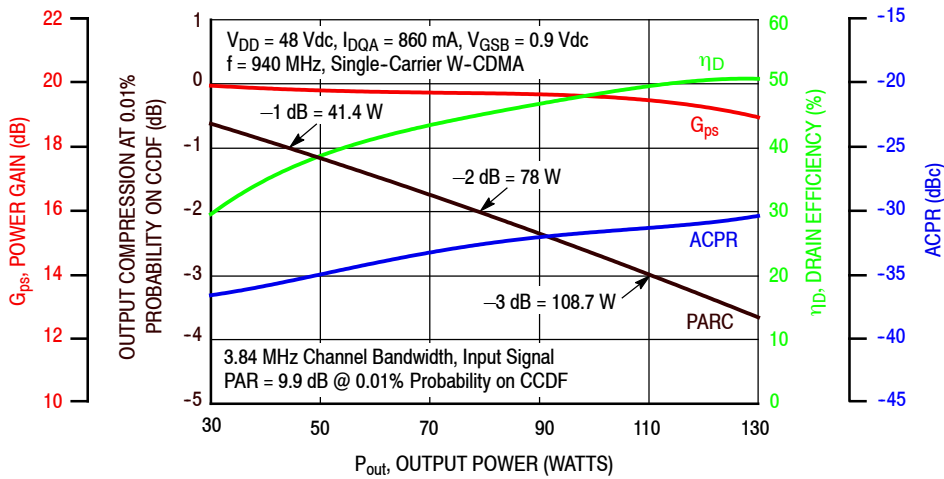
### TYPICAL CHARACTERISTICS



**Figure 3. Single-Carrier Output Peak-to-Average Ratio Compression (PARC) Broadband Performance @  $P_{out} = 100$  Watts Avg.**

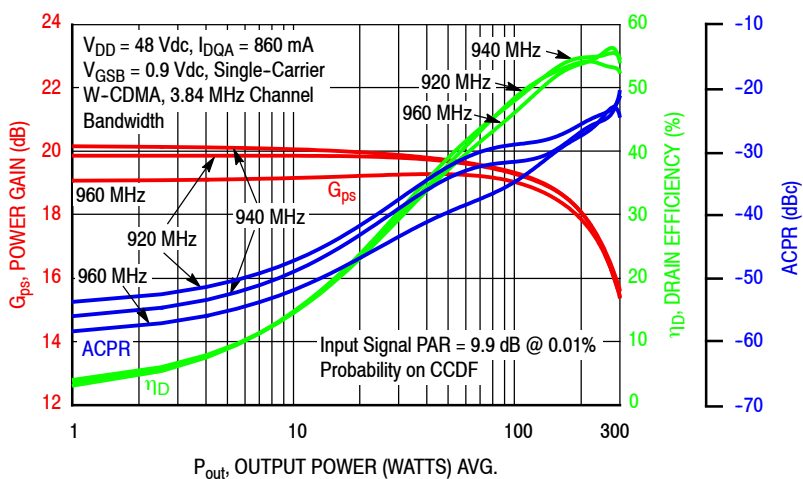


**Figure 4. Intermodulation Distortion Products versus Two-Tone Spacing**

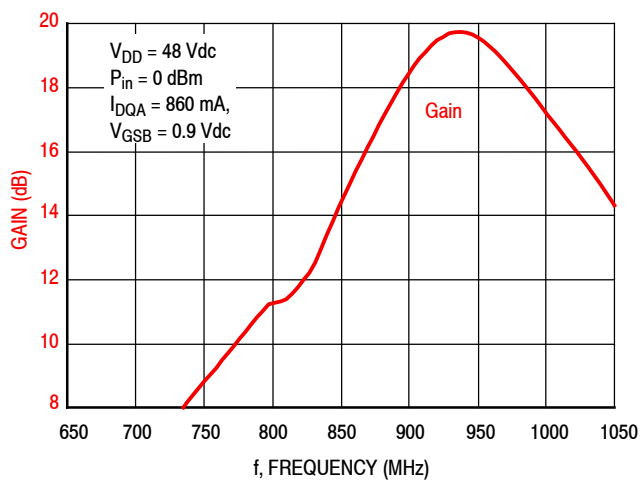


**Figure 5. Output Peak-to-Average Ratio Compression (PARC) versus Output Power**

### TYPICAL CHARACTERISTICS



**Figure 6. Single-Carrier W-CDMA Power Gain, Drain Efficiency and ACPR versus Output Power**



**Figure 7. Broadband Frequency Response**

**Table 7. Carrier Side Load Pull Performance — Maximum Power Tuning**
 $V_{DD} = 48 \text{ Vdc}$ ,  $I_{DQ} = 862 \text{ mA}$ , Pulsed CW,  $10 \mu\text{sec}(\text{on})$ , 10% Duty Cycle

| f (MHz) | $Z_{\text{source}} (\Omega)$ | $Z_{\text{in}} (\Omega)$ | Max Output Power                 |           |       |     |              |           |
|---------|------------------------------|--------------------------|----------------------------------|-----------|-------|-----|--------------|-----------|
|         |                              |                          | P1dB                             |           |       |     |              |           |
|         |                              |                          | $Z_{\text{load}}^{(1)} (\Omega)$ | Gain (dB) | (dBm) | (W) | $\eta_D$ (%) | AM/PM (°) |
| 920     | $2.39 - j3.65$               | $2.32 + j3.41$           | $1.84 + j0.12$                   | 21.3      | 54.1  | 260 | 59.9         | -14       |
| 940     | $2.54 - j4.03$               | $2.49 + j3.84$           | $1.85 + j0.11$                   | 21.3      | 54.1  | 258 | 59.9         | -14       |
| 960     | $2.90 - j4.64$               | $2.76 + j4.31$           | $1.77 + j0.13$                   | 21.2      | 54.1  | 259 | 59.8         | -15       |

| f (MHz) | $Z_{\text{source}} (\Omega)$ | $Z_{\text{in}} (\Omega)$ | Max Output Power                 |           |       |     |              |           |
|---------|------------------------------|--------------------------|----------------------------------|-----------|-------|-----|--------------|-----------|
|         |                              |                          | P3dB                             |           |       |     |              |           |
|         |                              |                          | $Z_{\text{load}}^{(2)} (\Omega)$ | Gain (dB) | (dBm) | (W) | $\eta_D$ (%) | AM/PM (°) |
| 920     | $2.39 - j3.65$               | $2.29 + j3.66$           | $2.11 - j0.03$                   | 19.1      | 54.8  | 301 | 61.1         | -19       |
| 940     | $2.54 - j4.03$               | $2.45 + j4.12$           | $2.04 - j0.03$                   | 19.2      | 54.8  | 299 | 60.8         | -18       |
| 960     | $2.90 - j4.64$               | $2.74 + j4.63$           | $1.97 - j0.01$                   | 19.1      | 54.8  | 300 | 60.6         | -19       |

(1) Load impedance for optimum P1dB power.

(2) Load impedance for optimum P3dB power.

$Z_{\text{source}}$  = Measured impedance presented to the input of the device at the package reference plane.

$Z_{\text{in}}$  = Impedance as measured from gate contact to ground.

$Z_{\text{load}}$  = Measured impedance presented to the output of the device at the package reference plane.

**Table 8. Carrier Side Load Pull Performance — Maximum Drain Efficiency Tuning**
 $V_{DD} = 48 \text{ Vdc}$ ,  $I_{DQ} = 862 \text{ mA}$ , Pulsed CW,  $10 \mu\text{sec}(\text{on})$ , 10% Duty Cycle

| f (MHz) | $Z_{\text{source}} (\Omega)$ | $Z_{\text{in}} (\Omega)$ | Max Drain Efficiency             |           |       |     |              |           |
|---------|------------------------------|--------------------------|----------------------------------|-----------|-------|-----|--------------|-----------|
|         |                              |                          | P1dB                             |           |       |     |              |           |
|         |                              |                          | $Z_{\text{load}}^{(1)} (\Omega)$ | Gain (dB) | (dBm) | (W) | $\eta_D$ (%) | AM/PM (°) |
| 920     | $2.39 - j3.65$               | $2.11 + j3.81$           | $1.51 + j1.85$                   | 24.3      | 51.5  | 140 | 71.8         | -20       |
| 940     | $2.54 - j4.03$               | $2.27 + j4.24$           | $1.43 + j1.84$                   | 24.3      | 51.4  | 138 | 71.9         | -21       |
| 960     | $2.90 - j4.64$               | $2.60 + j4.68$           | $1.46 + j1.61$                   | 23.8      | 52.2  | 164 | 71.6         | -20       |

| f (MHz) | $Z_{\text{source}} (\Omega)$ | $Z_{\text{in}} (\Omega)$ | Max Drain Efficiency             |           |       |     |              |           |
|---------|------------------------------|--------------------------|----------------------------------|-----------|-------|-----|--------------|-----------|
|         |                              |                          | P3dB                             |           |       |     |              |           |
|         |                              |                          | $Z_{\text{load}}^{(2)} (\Omega)$ | Gain (dB) | (dBm) | (W) | $\eta_D$ (%) | AM/PM (°) |
| 920     | $2.39 - j3.65$               | $2.22 + j3.95$           | $1.92 + j1.53$                   | 21.5      | 53.2  | 207 | 71.6         | -25       |
| 940     | $2.54 - j4.03$               | $2.38 + j4.45$           | $1.74 + j1.57$                   | 21.7      | 52.9  | 197 | 71.8         | -27       |
| 960     | $2.90 - j4.64$               | $2.66 + j4.94$           | $1.59 + j1.48$                   | 21.5      | 53.1  | 206 | 72.0         | -27       |

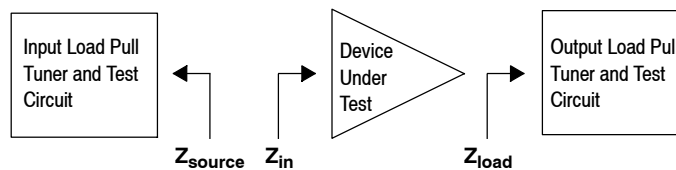
(1) Load impedance for optimum P1dB efficiency.

(2) Load impedance for optimum P3dB efficiency.

$Z_{\text{source}}$  = Measured impedance presented to the input of the device at the package reference plane.

$Z_{\text{in}}$  = Impedance as measured from gate contact to ground.

$Z_{\text{load}}$  = Measured impedance presented to the output of the device at the package reference plane.



**Table 9. Peaking Side Load Pull Performance — Maximum Power Tuning**
 $V_{DD} = 48 \text{ Vdc}$ ,  $V_{GSB} = 0.9 \text{ Vdc}$ , Pulsed CW, 10  $\mu\text{sec}(\text{on})$ , 10% Duty Cycle

| f<br>(MHz) | $Z_{\text{source}}$<br>( $\Omega$ ) | $Z_{\text{in}}$<br>( $\Omega$ ) | Max Output Power                        |           |       |     |                 |                       |
|------------|-------------------------------------|---------------------------------|---|-----------|-------|-----|-----------------|-----------------------|
|            |                                     |                                 | P1dB                                    |           |       |     |                 |                       |
|            |                                     |                                 | $Z_{\text{load}}^{(1)}$<br>( $\Omega$ ) | Gain (dB) | (dBm) | (W) | $\eta_D$<br>(%) | AM/PM<br>( $^\circ$ ) |
| 920        | 2.39 – j3.65                        | 2.33 + j3.43                    | 1.52 + j0.07                            | 16.8      | 54.7  | 294 | 66.5            | –25                   |
| 940        | 2.54 – j4.03                        | 2.44 + j3.87                    | 1.44 + j0.21                            | 16.9      | 54.6  | 291 | 66.9            | –25                   |
| 960        | 2.90 – j4.64                        | 2.64 + j4.34                    | 1.58 + j0.24                            | 17.0      | 54.5  | 283 | 66.5            | –25                   |

| f<br>(MHz) | $Z_{\text{source}}$<br>( $\Omega$ ) | $Z_{\text{in}}$<br>( $\Omega$ ) | Max Output Power                        |           |       |     |                 |                       |
|------------|-------------------------------------|---------------------------------|---|-----------|-------|-----|-----------------|-----------------------|
|            |                                     |                                 | P3dB                                    |           |       |     |                 |                       |
|            |                                     |                                 | $Z_{\text{load}}^{(2)}$<br>( $\Omega$ ) | Gain (dB) | (dBm) | (W) | $\eta_D$<br>(%) | AM/PM<br>( $^\circ$ ) |
| 920        | 2.39 – j3.65                        | 2.28 + j3.69                    | 1.68 – j0.06                            | 14.7      | 55.3  | 335 | 66.8            | –29                   |
| 940        | 2.54 – j4.03                        | 2.40 + j4.15                    | 1.60 + j0.13                            | 14.9      | 55.2  | 332 | 68.0            | –30                   |
| 960        | 2.90 – j4.64                        | 2.61 + j4.66                    | 1.71 + j0.14                            | 14.9      | 55.1  | 325 | 66.8            | –30                   |

(1) Load impedance for optimum P1dB power.

(2) Load impedance for optimum P3dB power.

 $Z_{\text{source}}$  = Measured impedance presented to the input of the device at the package reference plane.

 $Z_{\text{in}}$  = Impedance as measured from gate contact to ground.

 $Z_{\text{load}}$  = Measured impedance presented to the output of the device at the package reference plane.

**Table 10. Peaking Side Load Pull Performance — Maximum Drain Efficiency Tuning**
 $V_{DD} = 48 \text{ Vdc}$ ,  $V_{GSB} = 0.9 \text{ Vdc}$ , Pulsed CW, 10  $\mu\text{sec}(\text{on})$ , 10% Duty Cycle

| f<br>(MHz) | $Z_{\text{source}}$<br>( $\Omega$ ) | $Z_{\text{in}}$<br>( $\Omega$ ) | Max Drain Efficiency                    |           |       |     |                 |                       |
|------------|-------------------------------------|---------------------------------|---|-----------|-------|-----|-----------------|-----------------------|
|            |                                     |                                 | P1dB                                    |           |       |     |                 |                       |
|            |                                     |                                 | $Z_{\text{load}}^{(1)}$<br>( $\Omega$ ) | Gain (dB) | (dBm) | (W) | $\eta_D$<br>(%) | AM/PM<br>( $^\circ$ ) |
| 920        | 2.39 – j3.65                        | 2.22 + j3.39                    | 1.81 + j1.79                            | 17.5      | 52.4  | 174 | 78.9            | –29                   |
| 940        | 2.54 – j4.03                        | 2.27 + j3.80                    | 1.35 + j2.23                            | 17.6      | 51.2  | 131 | 81.4            | –35                   |
| 960        | 2.90 – j4.64                        | 2.43 + j4.27                    | 1.24 + j2.22                            | 17.6      | 51.2  | 131 | 81.6            | –36                   |

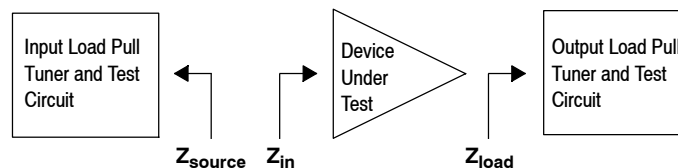
| f<br>(MHz) | $Z_{\text{source}}$<br>( $\Omega$ ) | $Z_{\text{in}}$<br>( $\Omega$ ) | Max Drain Efficiency                    |           |       |     |                 |                       |
|------------|-------------------------------------|---------------------------------|---|-----------|-------|-----|-----------------|-----------------------|
|            |                                     |                                 | P3dB                                    |           |       |     |                 |                       |
|            |                                     |                                 | $Z_{\text{load}}^{(2)}$<br>( $\Omega$ ) | Gain (dB) | (dBm) | (W) | $\eta_D$<br>(%) | AM/PM<br>( $^\circ$ ) |
| 920        | 2.39 – j3.65                        | 2.20 + j3.66                    | 2.07 + j1.45                            | 15.5      | 53.6  | 231 | 77.1            | –33                   |
| 940        | 2.54 – j4.03                        | 2.31 + j4.12                    | 1.86 + j1.49                            | 15.7      | 53.6  | 231 | 78.9            | –36                   |
| 960        | 2.90 – j4.64                        | 2.50 + j4.62                    | 1.70 + j1.64                            | 15.8      | 53.4  | 218 | 78.7            | –37                   |

(1) Load impedance for optimum P1dB efficiency.

(2) Load impedance for optimum P3dB efficiency.

 $Z_{\text{source}}$  = Measured impedance presented to the input of the device at the package reference plane.

 $Z_{\text{in}}$  = Impedance as measured from gate contact to ground.

 $Z_{\text{load}}$  = Measured impedance presented to the output of the device at the package reference plane.




### P1dB - TYPICAL CARRIER SIDE LOAD PULL CONTOURS — 940 MHz

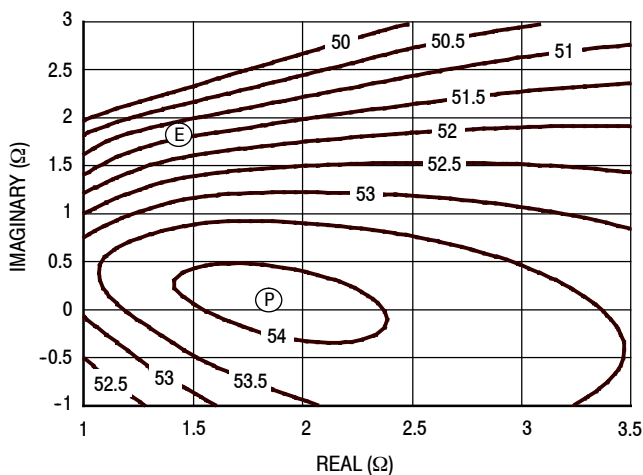


Figure 8. P1dB Load Pull Output Power Contours (dBm)

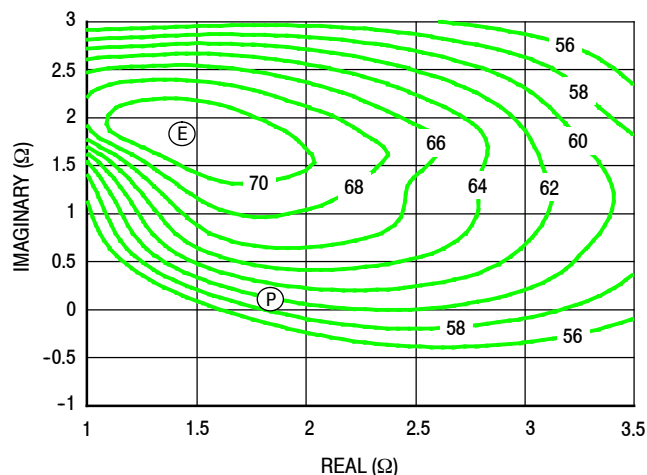


Figure 9. P1dB Load Pull Efficiency Contours (%)

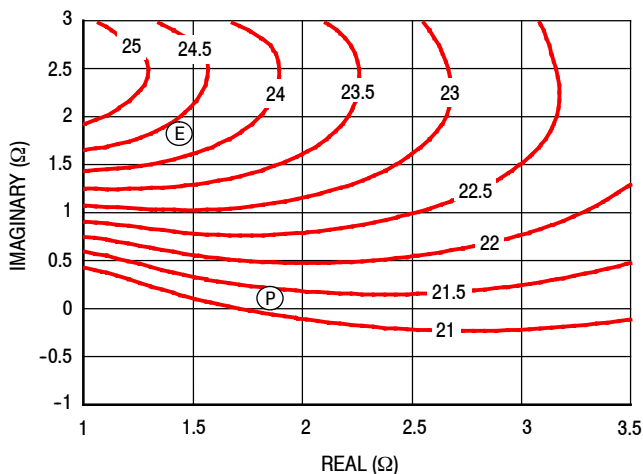


Figure 10. P1dB Load Pull Gain Contours (dB)

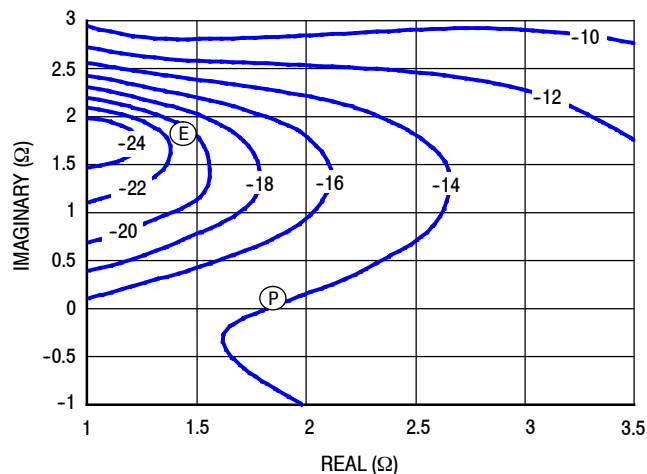


Figure 11. P1dB Load Pull AM/PM Contours (°)

**NOTE:** (P) = Maximum Output Power  
(E) = Maximum Drain Efficiency

- Gain
- Drain Efficiency
- Linearity
- Output Power

### P3dB - TYPICAL CARRIER SIDE LOAD PULL CONTOURS — 940 MHz

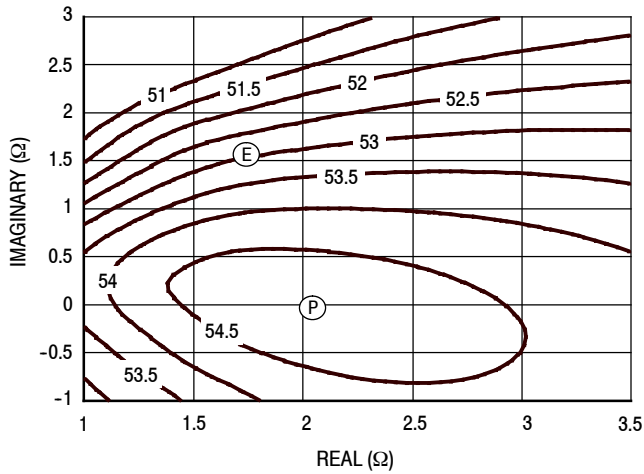


Figure 12. P3dB Load Pull Output Power Contours (dBm)

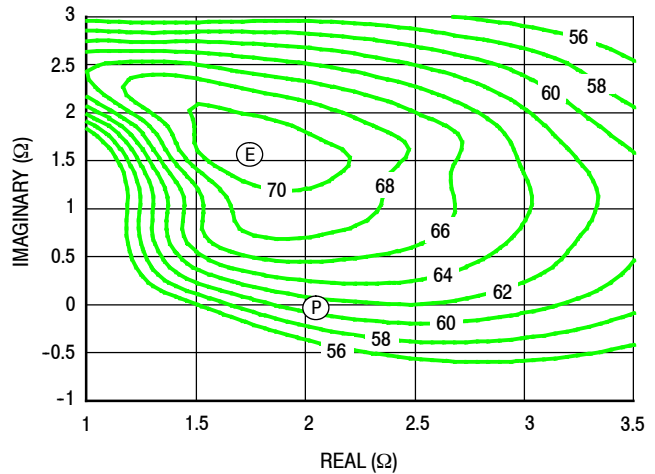


Figure 13. P3dB Load Pull Efficiency Contours (%)

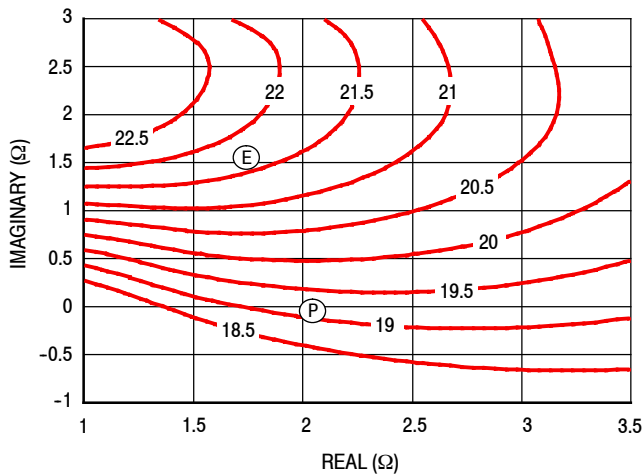


Figure 14. P3dB Load Pull Gain Contours (dB)

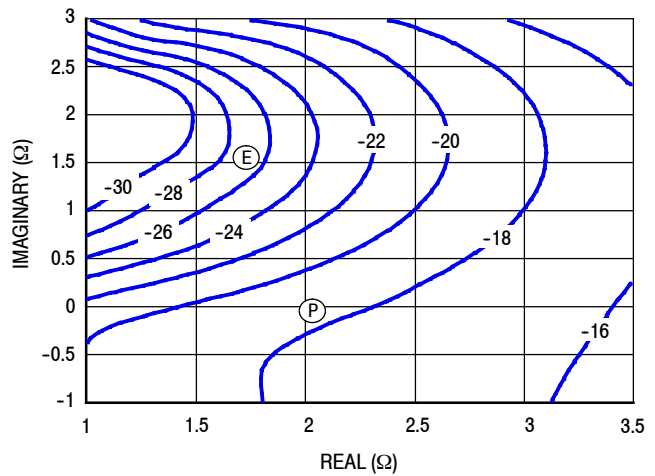


Figure 15. P3dB Load Pull AM/PM Contours (°)

**NOTE:** (P) = Maximum Output Power  
 (E) = Maximum Drain Efficiency

- Gain
- Drain Efficiency
- Linearity
- Output Power

### P1dB - TYPICAL PEAKING SIDE LOAD PULL CONTOURS — 940 MHz

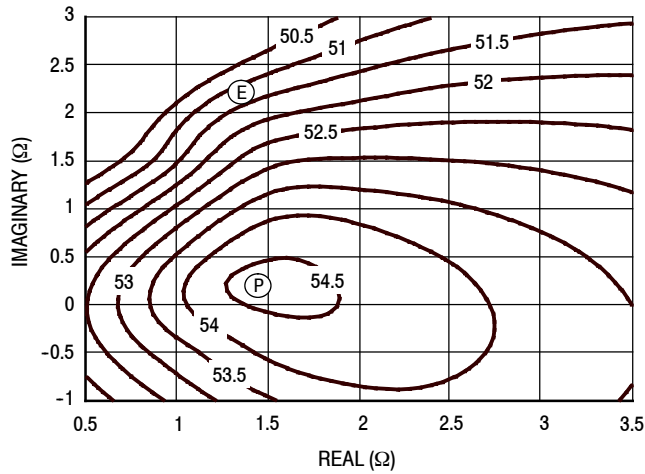


Figure 16. P1dB Load Pull Output Power Contours (dBm)

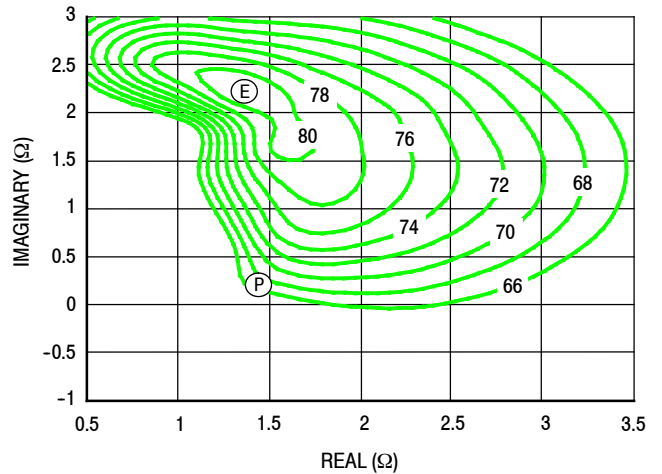


Figure 17. P1dB Load Pull Efficiency Contours (%)

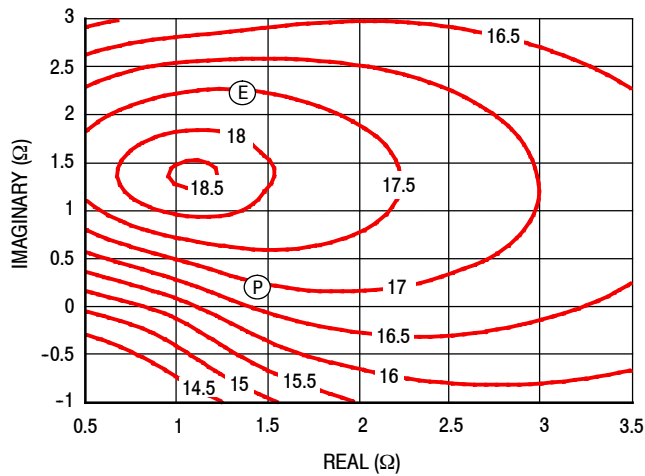


Figure 18. P1dB Load Pull Gain Contours (dB)

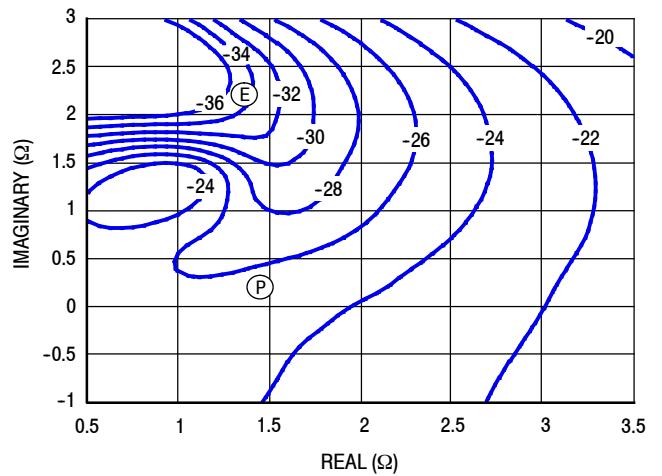


Figure 19. P1dB Load Pull AM/PM Contours (°)

**NOTE:** (P) = Maximum Output Power  
 (E) = Maximum Drain Efficiency

- Gain
- Drain Efficiency
- Linearity
- Output Power

### P3dB - TYPICAL PEAKING SIDE LOAD PULL CONTOURS — 940 MHz

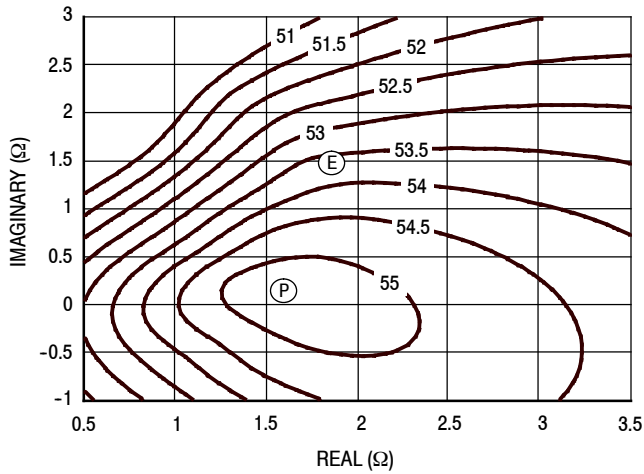


Figure 20. P3dB Load Pull Output Power Contours (dBm)

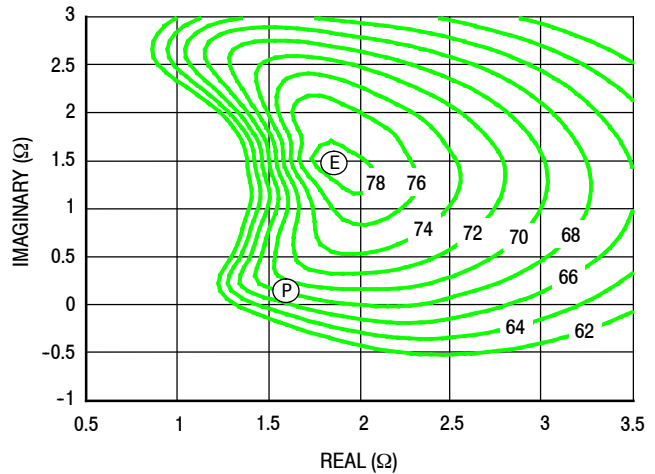


Figure 21. P3dB Load Pull Efficiency Contours (%)

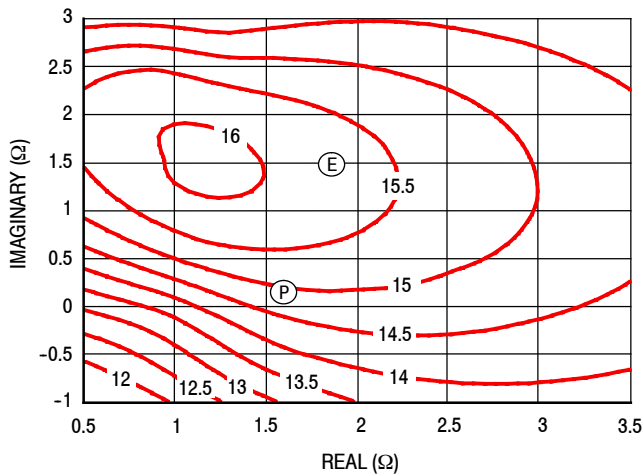


Figure 22. P3dB Load Pull Gain Contours (dB)

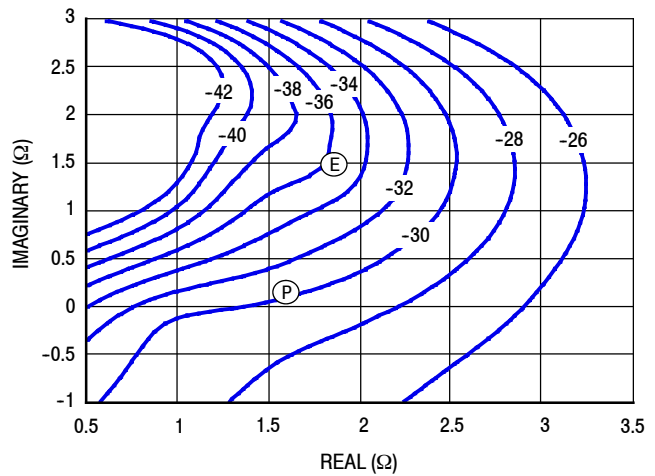
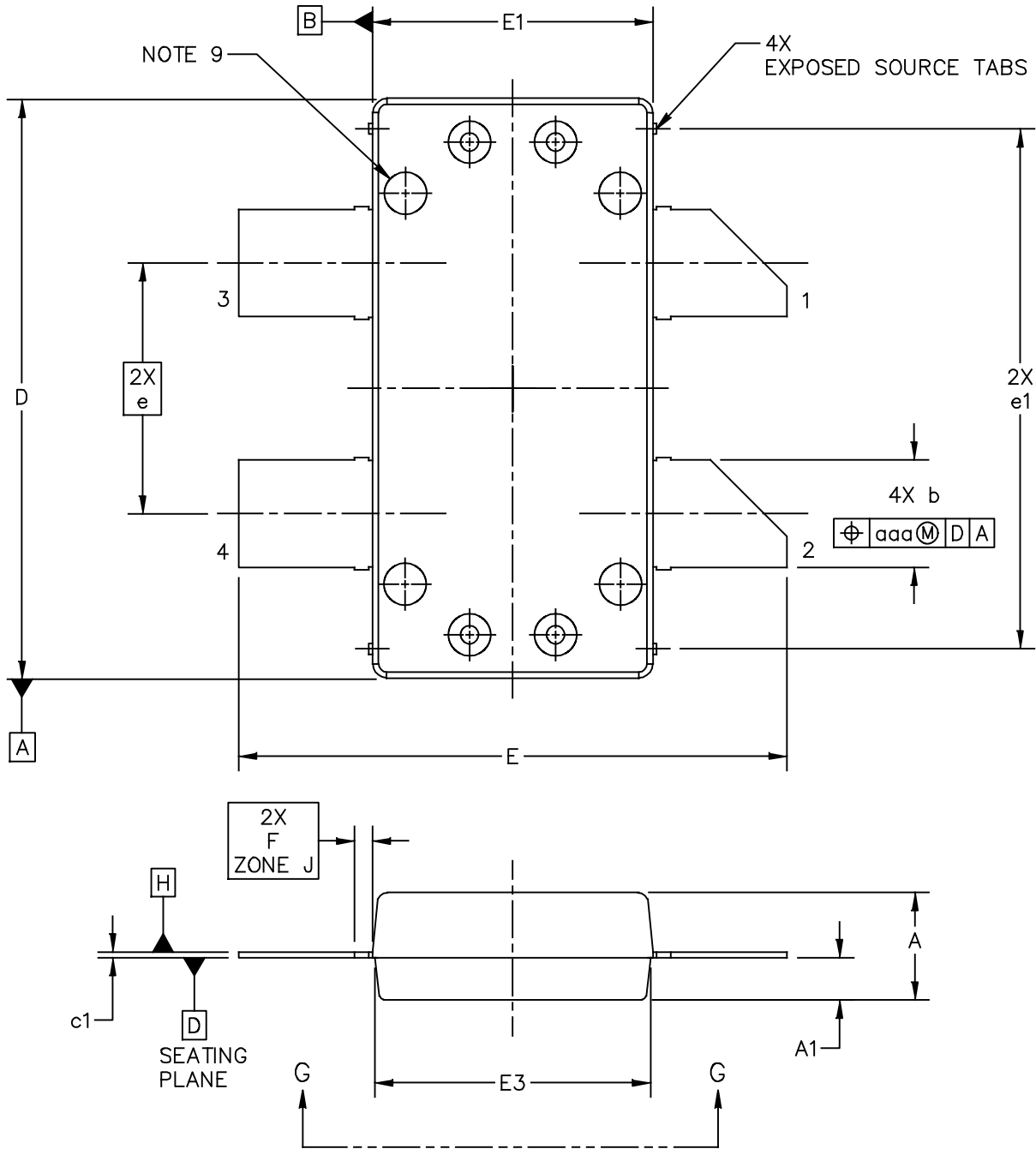


Figure 23. P3dB Load Pull AM/PM Contours (°)

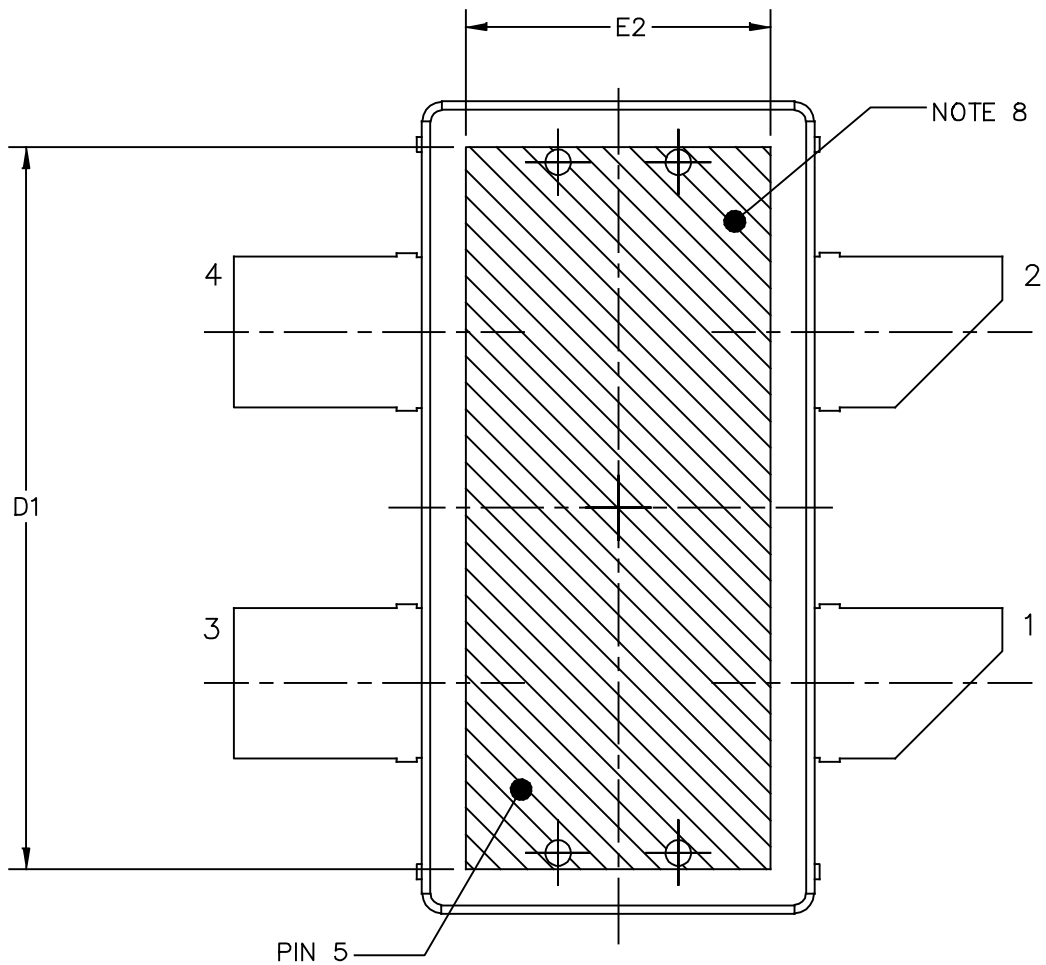
**NOTE:** (P) = Maximum Output Power  
 (E) = Maximum Drain Efficiency

- Gain
- Drain Efficiency
- Linearity
- Output Power

### PACKAGE DIMENSIONS



|   |  |                          |  |                            |  |
|---|--|--------------------------|--|----------------------------|--|
| © FREESCALE SEMICONDUCTOR, INC.<br>ALL RIGHTS RESERVED. |  | MECHANICAL OUTLINE       |  | PRINT VERSION NOT TO SCALE |  |
| TITLE:<br>OM780-4<br>STRAIGHT LEAD                      |  | DOCUMENT NO: 98ASA10833D |  | REV: A                     |  |
|   |  | CASE NUMBER: 2023-02     |  | 10 FEB 2010                |  |
|   |  | STANDARD: NON-JEDEC      |  |                            |  |



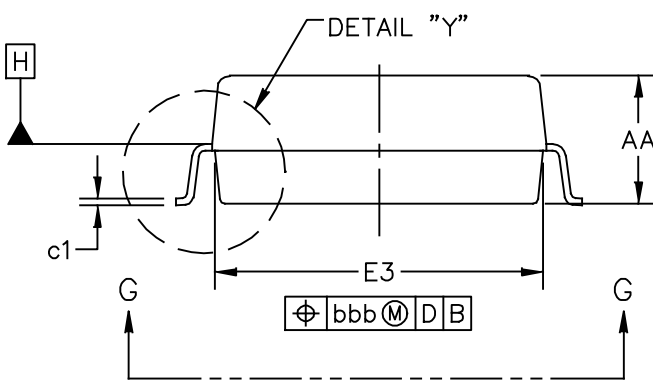
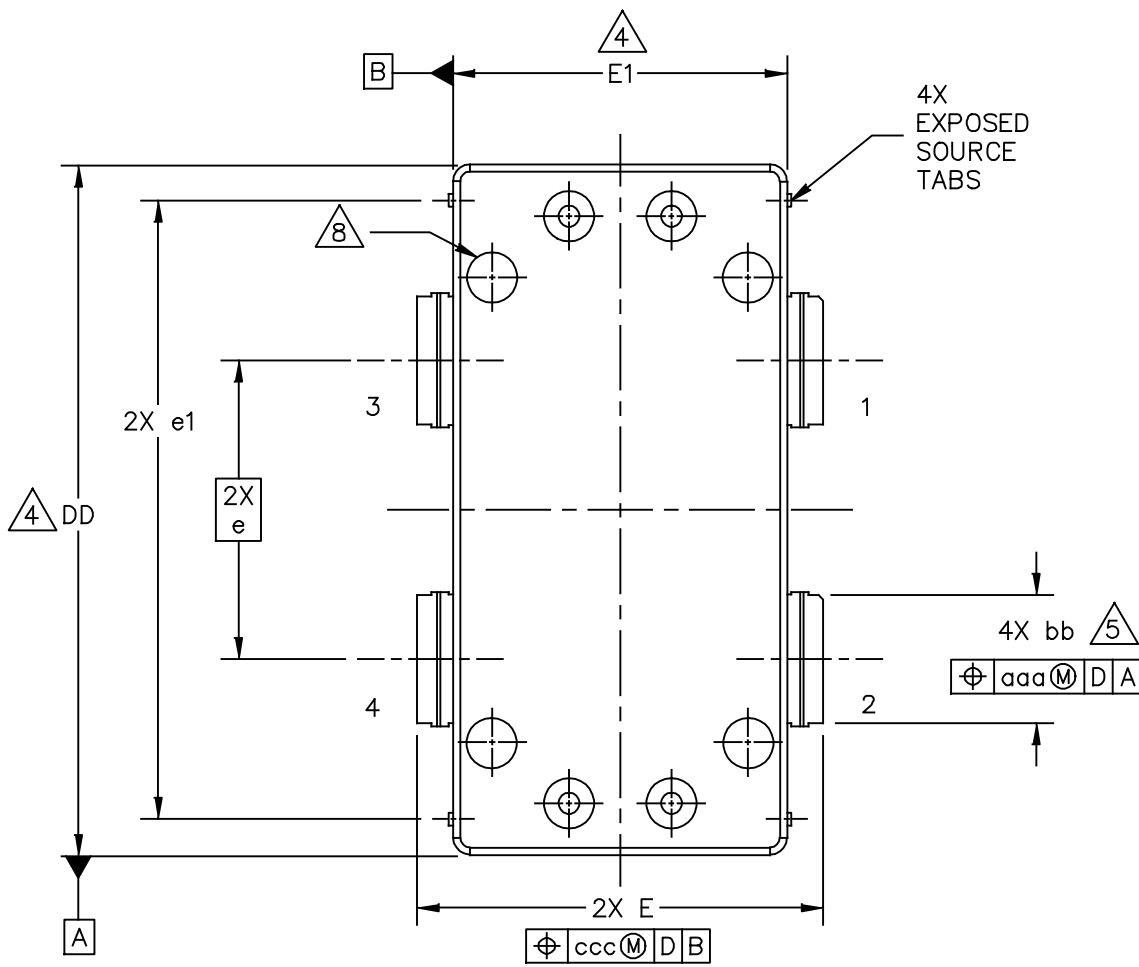
BOTTOM VIEW  
VIEW G-G

|   |                          |                            |  |
|---|--------------------------|----------------------------|--|
| © FREESCALE SEMICONDUCTOR, INC.<br>ALL RIGHTS RESERVED. | MECHANICAL OUTLINE       | PRINT VERSION NOT TO SCALE |  |
| TITLE:<br>OM780-4<br>STRAIGHT LEAD                      | DOCUMENT NO: 98ASA10833D | REV: A                     |  |
|   | CASE NUMBER: 2023-02     | 10 FEB 2010                |  |
|   | STANDARD: NON-JEDEC      |                            |  |

NOTES:

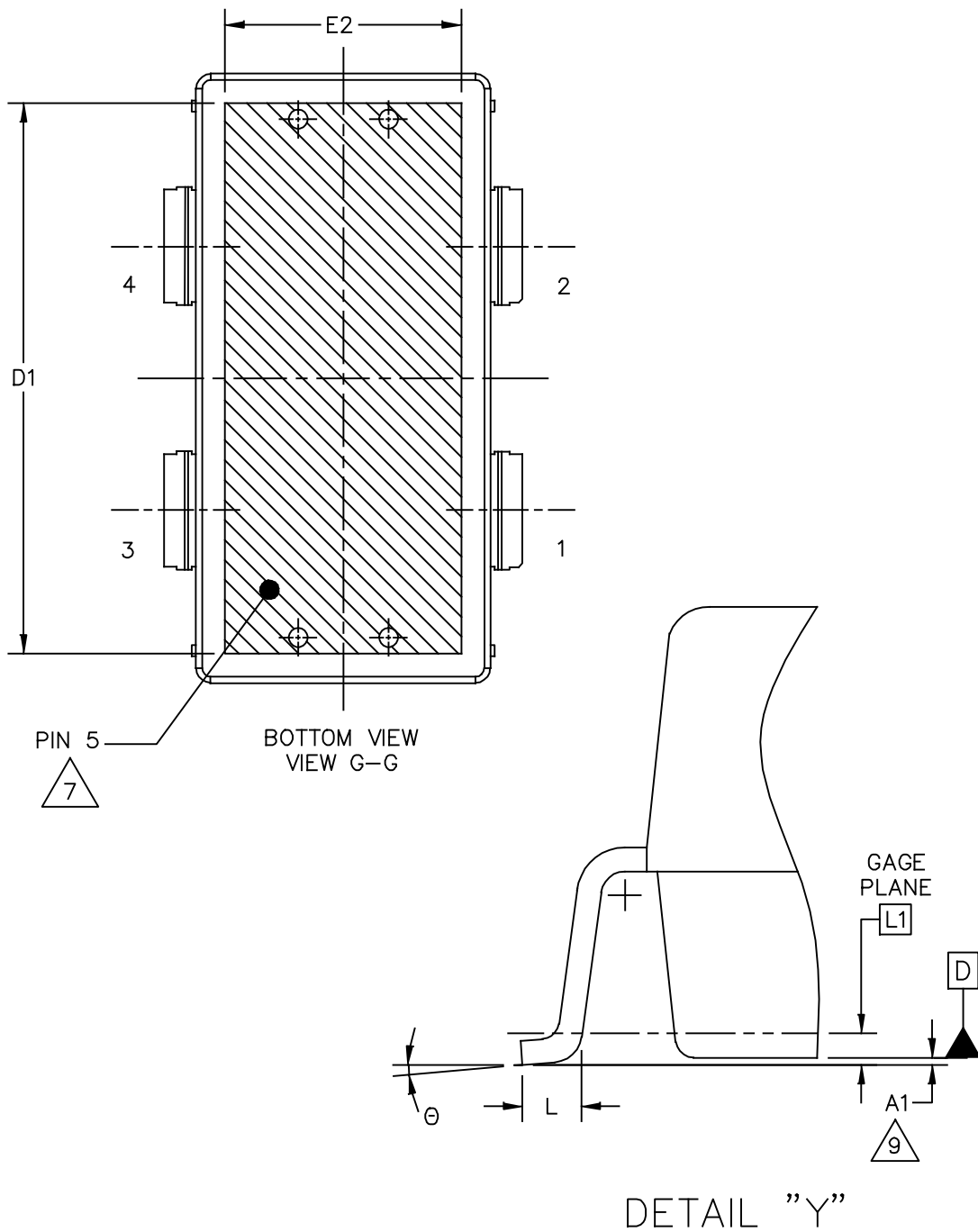
1. CONTROLLING DIMENSION: INCH
2. INTERPRET DIMENSIONS AND TOLERANCES PER ASME Y14.5M-1994.
3. DATUM PLANE -H- IS LOCATED AT TOP OF LEAD AND IS COINCIDENT WITH THE LEAD WHERE THE LEAD EXITS THE PLASTIC BODY AT THE TOP OF THE PARTING LINE.
4. DIMENSIONS "D" AND "E1" DO NOT INCLUDE MOLD PROTRUSION. ALLOWABLE PROTRUSION IS .006 PER SIDE. DIMENSIONS "D AND "E1" DO INCLUDE MOLD MISMATCH AND ARE DETERMINED AT DATUM PLANE -H-.
5. DIMENSION b DOES NOT INCLUDE DAMBAR PROTRUSION. ALLOWABLE DAMBAR PROTRUSION SHALL BE .005 TOTAL IN EXCESS OF THE b DIMENSION AT MAXIMUM MATERIAL CONDITION.
6. DATUMS -A- AND -B- TO BE DETERMINED AT DATUM PLANE -H-.
7. DIMENSION A1 APPLIES WITHIN ZONE "J" ONLY.
8. HATCHING REPRESENTS THE EXPOSED AREA OF THE HEAT SLUG. THE DIMENSIONS D1 AND E2 REPRESENT THE VALUES BETWEEN THE TWO OPPOSITE POINTS ALONG THE EDGES OF EXPOSED AREA OF HEAT SLUG.
9. DIMPLED HOLE REPRESENTS INPUT SIDE.

| DIM   | INCH     |      | MILLIMETER         |       | DIM                      | INCH                       |      | MILLIMETER  |       |
|---|----------|------|--------------------|-------|--------------------------|----------------------------|------|-------------|-------|
|   | MIN      | MAX  | MIN                | MAX   |                          | MIN                        | MAX  | MIN         | MAX   |
| A   | 0.148    | .152 | 3.76               | 3.86  | b                        | .147                       | .153 | 3.73        | 3.89  |
| A1  | .059     | .065 | 1.50               | 1.65  | c1                       | .007                       | .011 | 0.18        | 0.28  |
| D   | .808     | .812 | 20.52              | 20.62 | e                        | .350 BSC                   |      | 8.89 BSC    |       |
| D1  | .720     | ---- | 18.29              | ----  | e1                       | .721                       | .729 | 18.31       | 18.52 |
| E   | .762     | .770 | 19.36              | 19.56 | aaa                      | .004                       |      | 0.10        |       |
| E1  | .390     | .394 | 9.91               | 10.01 |                          |                            |      |             |       |
| E2  | .306     | ---- | 7.77               | ----  |                          |                            |      |             |       |
| E3  | .383     | .387 | 9.72               | 9.83  |                          |                            |      |             |       |
| F   | .025 BSC |      | 0.635 BSC          |       |                          |                            |      |             |       |
| © FREESCALE SEMICONDUCTOR, INC.<br>ALL RIGHTS RESERVED. |          |      | MECHANICAL OUTLINE |       |                          | PRINT VERSION NOT TO SCALE |      |             |       |
| TITLE:<br><br>OM780-4<br>STRAIGHT LEAD                  |          |      |                    |       | DOCUMENT NO: 98ASA10833D |                            |      | REV: A      |       |
|   |          |      |                    |       | CASE NUMBER: 2023-02     |                            |      | 10 FEB 2010 |       |
|   |          |      |                    |       | STANDARD: NON-JEDEC      |                            |      |             |       |



|   |                          |                            |
|---|--------------------------|----------------------------|
| © FREESCALE SEMICONDUCTOR, INC.<br>ALL RIGHTS RESERVED. | MECHANICAL OUTLINE       | PRINT VERSION NOT TO SCALE |
| TITLE:<br><br>OM-780G-4L                                | DOCUMENT NO: 98ASA10834D | REV: D                     |
|   | STANDARD: NON-JEDEC      |                            |
|   | 14 NOV 2013              |                            |





|   |                          |                            |        |
|---|--------------------------|----------------------------|--------|
| © FREESCALE SEMICONDUCTOR, INC.<br>ALL RIGHTS RESERVED. | MECHANICAL OUTLINE       | PRINT VERSION NOT TO SCALE |        |
| TITLE:<br><br>OM-780G-4L                                | DOCUMENT NO: 98ASA10834D |                            | REV: D |
|   | STANDARD: NON-JEDEC      |                            |        |
|   | 14 NOV 2013              |                            |        |

NOTES:

1. CONTROLLING DIMENSION: INCH
2. INTERPRET DIMENSIONS AND TOLERANCES PER ASME Y14.5M-1994.
3. DATUM PLANE H IS LOCATED AT TOP OF LEAD AND IS COINCIDENT WITH THE LEAD WHERE THE LEAD EXITS THE PLASTIC BODY AT THE TOP OF THE PARTING LINE.
4. DIMENSIONS DD AND E1 DO NOT INCLUDE MOLD PROTRUSION. ALLOWABLE PROTRUSION IS .006 INCH (0.15 MM) PER SIDE. DIMENSIONS DD AND E1 DO INCLUDE MOLD MISMATCH AND ARE DETERMINED AT DATUM PLANE H.
5. DIMENSION bb DOES NOT INCLUDE DAMBAR PROTRUSION. ALLOWABLE DAMBAR PROTRUSION SHALL BE .005 INCH (0.13 MM) TOTAL IN EXCESS OF THE bb DIMENSION AT MAXIMUM MATERIAL CONDITION.
6. DATUMS A AND B TO BE DETERMINED AT DATUM PLANE H.
7. HATCHING REPRESENTS THE EXPOSED AREA OF THE HEAT SLUG. THE DIMENSIONS D1 AND E2 REPRESENT THE VALUES BETWEEN THE TWO OPPOSITE POINTS ALONG THE EDGES OF EXPOSED AREA OF HEAT SLUG.
8. DIMPLED HOLE REPRESENTS INPUT SIDE.
9. DIMENSION A1 IS MEASURED WITH REFERENCE TO DATUM D. THE POSITIVE VALUE IMPLIES THAT THE BOTTOM OF PACKAGE IS HIGHER THAN THE BOTTOM OF THE LEAD.

| DIM | INCH     |      | MILLIMETER |       | DIM | INCH      |      | MILLIMETER |       |
|-----|----------|------|------------|-------|-----|-----------|------|------------|-------|
|     | MIN      | MAX  | MIN        | MAX   |     | MIN       | MAX  | MIN        | MAX   |
| AA  | .148     | .152 | 3.76       | 3.86  | bb  | .147      | .153 | 3.73       | 3.89  |
| A1  | -.002    | .002 | -0.05      | 0.05  | c1  | .007      | .011 | 0.18       | 0.28  |
| DD  | .808     | .812 | 20.52      | 20.62 | e   | 0.350 BSC |      | 8.89 BSC   |       |
| D1  | .720     | ---- | 18.29      | ----  | e1  | .721      | .729 | 18.31      | 18.52 |
| E   | .470     | .482 | 11.94      | 12.24 | θ   | 0°        | 8°   | 0°         | 8°    |
| E1  | .390     | .394 | 9.91       | 10.01 | aaa | .004      |      | 0.10       |       |
| E2  | .306     | ---- | 7.77       | ----  | bbb | .006      |      | 0.15       |       |
| E3  | .383     | .387 | 9.73       | 9.83  | ccc | .010      |      | 0.25       |       |
| L   | .018     | .024 | 0.46       | 0.61  |     |           |      |            |       |
| L1  | .010 BSC |      | 0.25 BSC   |       |     |           |      |            |       |

|   |  |                    |                          |                            |        |             |  |
|---|--|--------------------|--------------------------|----------------------------|--------|-------------|--|
| © FREESCALE SEMICONDUCTOR, INC.<br>ALL RIGHTS RESERVED. |  | MECHANICAL OUTLINE |                          | PRINT VERSION NOT TO SCALE |        |             |  |
| TITLE:<br><br>OM-780G-4L                                |  |                    | DOCUMENT NO: 98ASA10834D |                            | REV: D |             |  |
|   |  |                    | STANDARD: NON-JEDEC      |                            |        |             |  |
|   |  |                    |                          |                            |        | 14 NOV 2013 |  |

## PRODUCT DOCUMENTATION, SOFTWARE AND TOOLS

Refer to the following documents, software and tools to aid your design process.

### Application Notes

- AN1955: Thermal Measurement Methodology of RF Power Amplifiers

### Engineering Bulletins

- EB212: Using Data Sheet Impedances for RF LDMOS Devices

### Software

- Electromigration MTTF Calculator
- RF High Power Model
- .s2p File

### Development Tools

- Printed Circuit Boards

For Software and Tools, do a Part Number search at <http://www.freescale.com>, and select the “Part Number” link. Go to the Software & Tools tab on the part’s Product Summary page to download the respective tool.

## REVISION HISTORY

The following table summarizes revisions to this document.

| Revision | Date      | Description                     |
|----------|-----------|---------------------------------|
| 0        | Jan. 2014 | • Initial Release of Data Sheet |