

RF Power LDMOS Transistors

High Ruggedness N-Channel Enhancement-Mode Lateral MOSFETs

These RF power transistors are designed for pulse applications operating at frequencies from 960 to 1215 MHz, such as distance measuring equipment (DME), secondary radars and high power transponders for air traffic control. These devices are suitable for use in pulse applications with large duty cycles and long pulses, including Mode S ELM.

Typical Short Pulse Performance: In 960–1215 MHz reference circuit, $V_{DD} = 50$ Vdc, $I_{DQ} = 100$ mA, $P_{in} = 25$ W

Frequency (MHz)	Signal Type	P_{out} (W)	G_{ps} (dB)	η_D (%)
960	Pulse (128 μ sec, 10% Duty Cycle)	1390 Peak	17.5	51.1
1030		1410 Peak	17.5	51.8
1090		1370 Peak	17.4	52.2
1215		1230 Peak	16.9	55.8

Typical Long Pulse Performance: In 960–1215 MHz reference circuit, $V_{DD} = 50$ Vdc, $I_{DQ} = 100$ mA, $P_{in} = 25$ W

Frequency (MHz)	Signal Type	P_{out} (W)	G_{ps} (dB)	η_D (%)
960	Pulse (2 msec, 10% Duty Cycle)	1160 Peak	16.6	50.8
1030		1190 Peak	16.8	52.1
1090		1210 Peak	16.8	49.2
1215		1060 Peak	16.2	50.6

Load Mismatch/Ruggedness

Frequency (MHz)	Signal Type	VSWR	P_{in} (W)	Test Voltage	Result
1030 (1)	Pulse (128 μ sec, 10% Duty Cycle)	> 20:1 at all Phase Angles	25 Peak (3 dB Overdrive)	50	No Device Degradation

1. Measured in 960–1215 MHz reference circuit.

Features

- Internally Input and Output Matched for Broadband Operation and Ease of Use
- Device Can Be Used Single-Ended, Push-Pull, or in a Quadrature Configuration
- Qualified up to a Maximum of 50 V_{DD} Operation
- High Ruggedness, Handles > 20:1 VSWR
- Integrated ESD Protection with Greater Negative Voltage Range for Improved Class C Operation and Gate Voltage Pulsing
- Characterized with Series Equivalent Large-Signal Impedance Parameters

Typical Applications

- Air Traffic Control Systems (ATC), Including Ground-based Secondary Radars such as Mode S ELM Interrogators
- Distance Measuring Equipment (DME)
- Mode S Transponders, Including:
 - Traffic Alert and Collision Avoidance Systems (TCAS)
 - Automatic Dependent Surveillance-Broadcast In and Out (ADS-B) Using, e.g., 1090 Extended Squitter or Universal Access Transponder (UAT)

AFV121KH
AFV121KHS
AFV121KGS

960–1215 MHz, 1000 W PEAK, 50 V
AIRFAST RF POWER LDMOS
TRANSISTORS

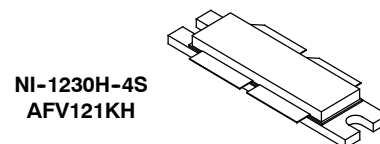

NI-1230H-4S
AFV121KH

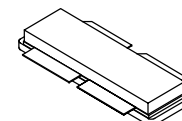

NI-1230S-4S
AFV121KHS

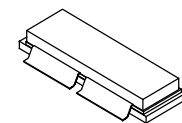

NI-1230GS-4L
AFV121KGS

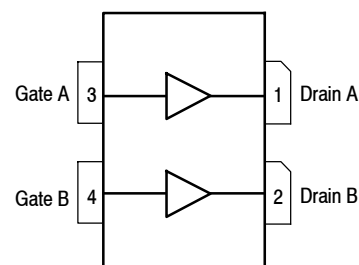

(Top View)

Note: The backside of the package is the source terminal for the transistors.

Figure 1. Pin Connections

Table 1. Maximum Ratings

Rating	Symbol	Value	Unit
Drain-Source Voltage	V_{DSS}	-0.5, +112	Vdc
Gate-Source Voltage	V_{GS}	-6.0, +10	Vdc
Storage Temperature Range	T_{stg}	-65 to +150	°C
Case Operating Temperature Range	T_C	-40 to 150	°C
Operating Junction Temperature Range (1,2)	T_J	-40 to 225	°C

Table 2. Thermal Characteristics

Characteristic	Symbol	Value (2,3)	Unit
Thermal Impedance, Junction to Case Pulse: Case Temperature 64°C, 1000 W Peak, 128 μ sec Pulse Width, 10% Duty Cycle, 50 Vdc, $I_{DQ} = 100$ mA, 1030 MHz (4) Pulse: Case Temperature 65°C, 1000 W Peak, 2 msec Pulse Width, 10% Duty Cycle, 50 Vdc, $I_{DQ} = 100$ mA, 1030 MHz (4)	$Z_{\theta JC}$	0.017 0.050	°C/W

Table 3. ESD Protection Characteristics

Test Methodology	Class
Human Body Model (per JESD22-A114)	2, passes 2500 V
Machine Model (per EIA/JESD22-A115)	B, passes 250 V
Charge Device Model (per JESD22-C101)	IV, passes 2000 V

Table 4. Electrical Characteristics ($T_A = 25^\circ\text{C}$ unless otherwise noted)

Characteristic	Symbol	Min	Typ	Max	Unit
----------------	--------	-----	-----	-----	------

Off Characteristics (5)

Gate-Source Leakage Current ($V_{GS} = 5$ Vdc, $V_{DS} = 0$ Vdc)	I_{GSS}	—	—	1	μ Adc
Drain-Source Breakdown Voltage ($V_{GS} = 0$ Vdc, $I_D = 10$ μ A)	$V_{(BR)DSS}$	112	—	—	Vdc
Zero Gate Voltage Drain Leakage Current ($V_{DS} = 50$ Vdc, $V_{GS} = 0$ Vdc)	I_{DSS}	—	—	1	μ Adc
Zero Gate Voltage Drain Leakage Current ($V_{DS} = 112$ Vdc, $V_{GS} = 0$ Vdc)	I_{DSS}	—	—	10	μ Adc

On Characteristics

Gate Threshold Voltage (5) ($V_{DS} = 10$ Vdc, $I_D = 520$ μ Adc)	$V_{GS(th)}$	1.3	1.8	2.3	Vdc
Gate Quiescent Voltage (6) ($V_{DD} = 50$ Vdc, $I_D = 100$ mAdc, Measured in Functional Test)	$V_{GS(Q)}$	1.5	2.0	2.5	Vdc
Drain-Source On-Voltage (5) ($V_{GS} = 10$ Vdc, $I_D = 2.6$ Adc)	$V_{DS(on)}$	0.05	0.17	0.35	Vdc

Dynamic Characteristics (5)

Reverse Transfer Capacitance ($V_{DS} = 50$ Vdc \pm 30 mV(rms)ac @ 1 MHz, $V_{GS} = 0$ Vdc)	C_{rss}	—	2.5	—	pF
---	-----------	---	-----	---	----

1. Continuous use at maximum temperature will affect MTTF.
2. MTTF calculator available at <http://www.freescale.com/rf/calculators>.
3. Refer to [AN1955](#), *Thermal Measurement Methodology of RF Power Amplifiers*. Go to <http://www.freescale.com/rf> and search for AN1955.
4. Measured in 960-1215 MHz reference circuit.
5. Each side of device measured separately.
6. Measurement made with device in push-pull configuration.

(continued)

Table 4. Electrical Characteristics ($T_A = 25^\circ\text{C}$ unless otherwise noted) (continued)

Characteristic	Symbol	Min	Typ	Max	Unit
Functional Tests ^(1,2) (In Freescale Narrowband Production Test Fixture, 50 ohm system) $V_{DD} = 50\text{ Vdc}$, $I_{DQ(A+B)} = 100\text{ mA}$, $P_{out} = 1000\text{ W Peak}$ (100 W Avg.), $f = 1030\text{ MHz}$, 128 μsec Pulse Width, 10% Duty Cycle					
Power Gain	G_{ps}	18.5	19.6	22.0	dB
Drain Efficiency	η_D	55.5	59.7	—	%
Input Return Loss	IRL	—	-15	-9	dB

Table 5. Load Mismatch/Ruggedness (In Freescale Narrowband Production Test Fixture, 50 ohm system) $I_{DQ(A+B)} = 100\text{ mA}$

Frequency (MHz)	Signal Type	VSWR	P_{in} (W)	Test Voltage, V_{DD}	Result
1030	Pulse (128 μsec , 10% Duty Cycle)	> 20:1 at all Phase Angles	20.2 Peak (3 dB Overdrive)	50	No Device Degradation

Table 6. Ordering Information

Device	Tape and Reel Information	Package
AFV121KHR5	R5 Suffix = 50 Units, 56 mm Tape Width, 13-inch Reel	NI-1230H-4S, Eared
AFV121KHSR5		NI-1230S-4S, Earless
AFV121KGSR5		NI-1230GS-4L, Gull Wing

1. Measurement made with device in push-pull configuration.
2. Measurements made with device in straight lead configuration before any lead forming operation is applied. Lead forming is used for gull wing (GS) parts.

TYPICAL CHARACTERISTICS

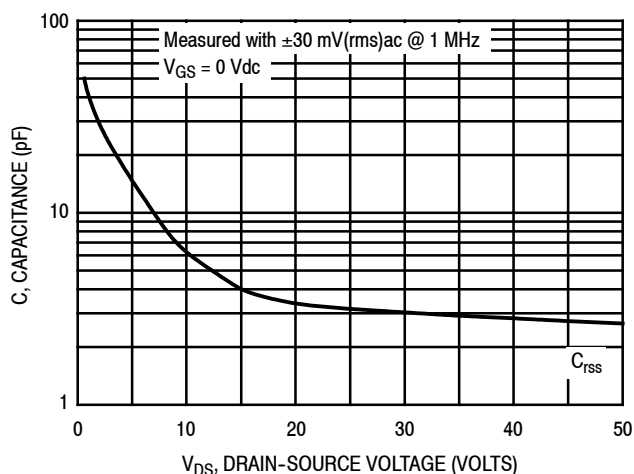

Note: Each side of device measured separately.

Figure 2. Capacitance versus Drain-Source Voltage

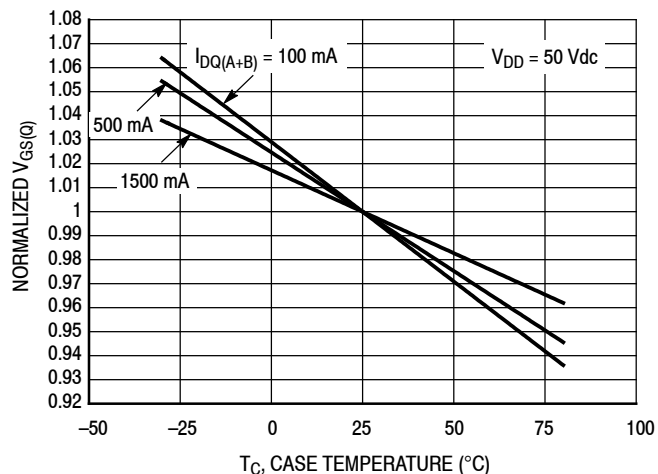

I_{DQ} (mA)	Slope (mV/°C)
100	-2.36
500	-2.26
1500	-1.84

Figure 3. Normalized V_{GS} versus Quiescent Current and Case Temperature

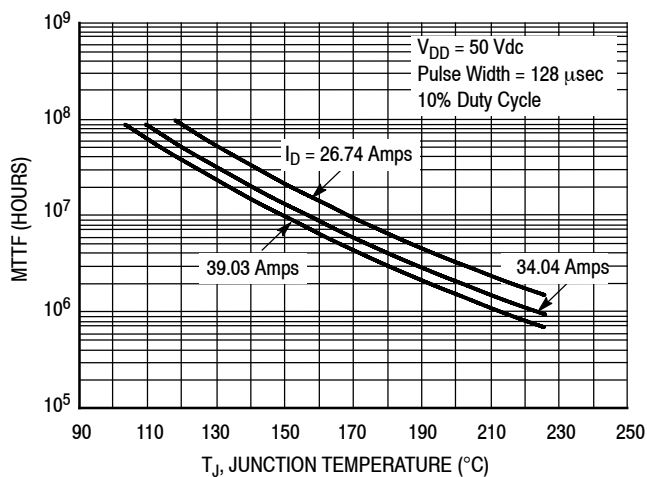

Note: MTTF value represents the total cumulative operating time under indicated test conditions.

MTTF calculator available at <http://www.freescale.com/rt/calculators>

Figure 4. MTTF versus Junction Temperature - Pulse

960–1215 MHz REFERENCE CIRCUIT — 3" x 4" (7.62 cm x 10.16 cm)

Table 7. 960–1215 MHz Performance (In Freescale Reference Circuit, 50 ohm system)

$V_{DD} = 50$ Vdc, $I_{DQ(A+B)} = 100$ mA, $P_{in} = 25$ W

Frequency (MHz)	Signal Type	G_{ps} (dB)	η_D (%)	P_{out} (W)
960	Pulse (128 μ sec, 10% Duty Cycle)	17.5	51.1	1390 Peak
1030		17.5	51.8	1410 Peak
1090		17.4	52.2	1370 Peak
1215		16.9	55.8	1230 Peak

Table 8. Load Mismatch/Ruggedness (In Freescale 960–1215 MHz Reference Circuit, 50 ohm system) $I_{DQ(A+B)} = 100$ mA

Frequency (MHz)	Signal Type	VSWR	P_{in} (W)	Test Voltage, V_{DD}	Result
1030	Pulse (128 μ sec, 10% Duty Cycle)	> 20:1 at all Phase Angles	25 Peak (3 dB Overdrive)	50	No Device Degradation

960–1215 MHz REFERENCE CIRCUIT — 3" x 4" (7.62 cm x 10.16 cm)

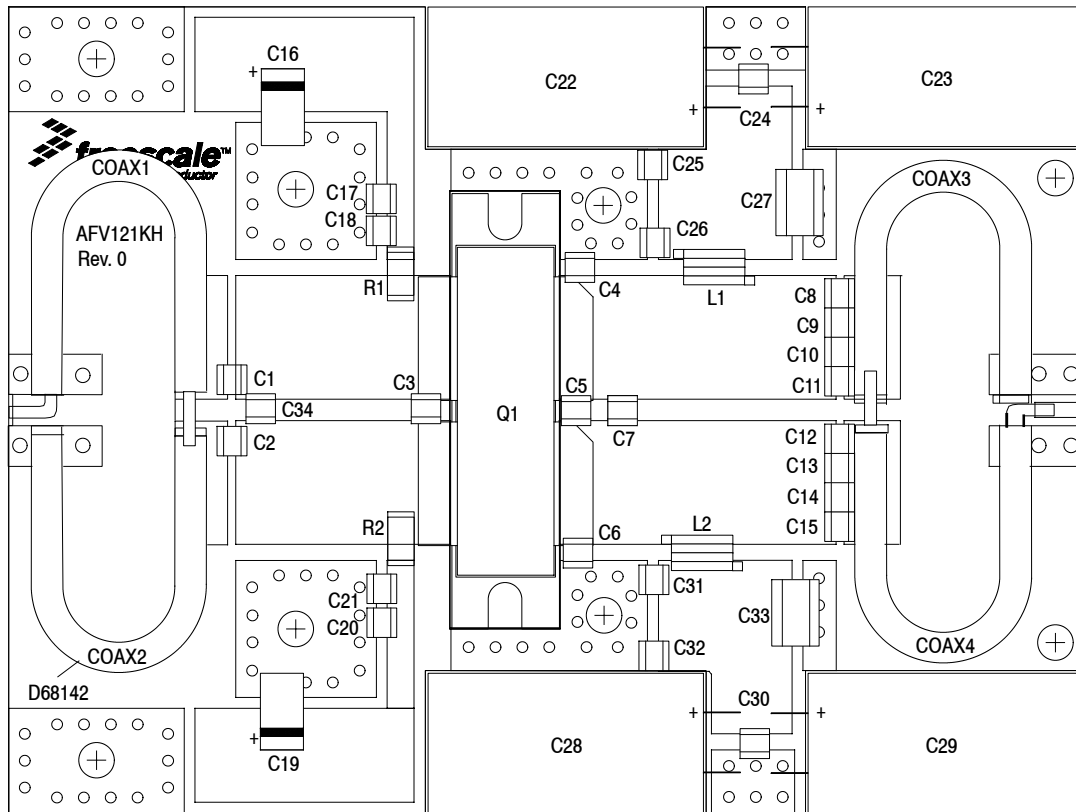

Figure 5. AFV121KH(HS) 960–1215 MHz Reference Circuit Component Layout

Table 9. AFV121KH(HS) 960–1215 MHz Reference Circuit Component Designations and Values

Part	Description	Part Number	Manufacturer
C1, C2	5.6 pF Chip Capacitors	ATC100B5R6CT500XT	ATC
C3	4.3 pF Chip Capacitor	ATC100B4R3CT500XT	ATC
C4, C6	10 pF Chip Capacitors	ATC800B100JT500XT	ATC
C5	4.7 pF Chip Capacitor	ATC800B4R7CT500XT	ATC
C7	5.1 pF Chip Capacitor	ATC800B5R1CT500XT	ATC
C8, C9 C10, C11, C12, C13, C14, C15	2.2 pF Chip Capacitors	ATC800B2R2BT500XT	ATC
C16, C19	22 μ F, 25 V Tantalum Capacitors	TPSD226M025R0200	AVX
C17, C20	0.22 μ F Chip Capacitors	C1210C224K1RACTU	Kemet
C18, C21, C24, C30	36 pF Chip Capacitors	ATC100B360JT500XT	ATC
C22, C23, C28, C29	470 μ F, 63 V Electrolytic Capacitors	MCGPR63V477M13X26-RH	Multicomp
C25, C26, C31, C32	2.2 μ F Chip Capacitors	C3225X7R2A225K230AB	TDK
C27, C33	0.022 μ F Chip Capacitors	C1825C223K1GACTU	Kemet
C34	1.7 pF Chip Capacitor	ATC100B1R7BT500XT	ATC
Coax1, Coax2, Coax3, Coax4	35 Ω Flex Cable 1.9"	HSF-141C-35	Hongsen Cable
L1, L2	6.6 η H, 2 Turn Inductors	GA3093-ALC	Coilcraft
Q1	RF Power LDMOS Transistor	AFV121KHR5	Freescale
R1, R2	1000 Ω , 1/2 W Chip Resistors	CRCW20101K00FKEF	Vishay
PCB	Arlon 450 0.030", $\epsilon_r = 4.5$	D68142	MTL

TYPICAL CHARACTERISTICS — 960–1215 MHz REFERENCE CIRCUIT

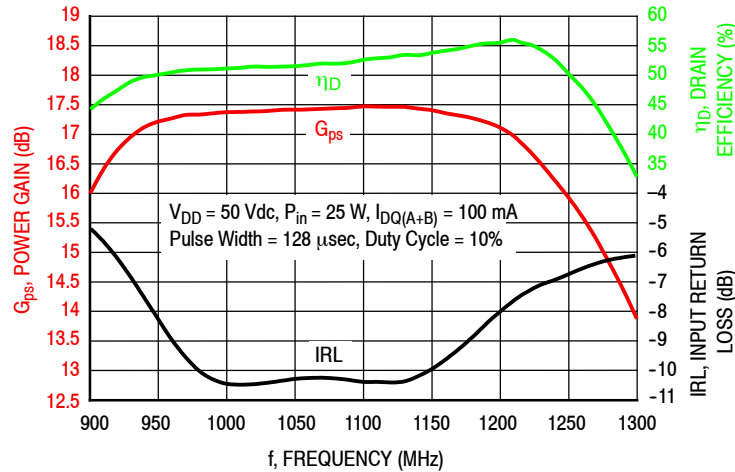

Figure 6. Power Gain, Drain Efficiency and IRL versus Frequency at a Constant Input Power

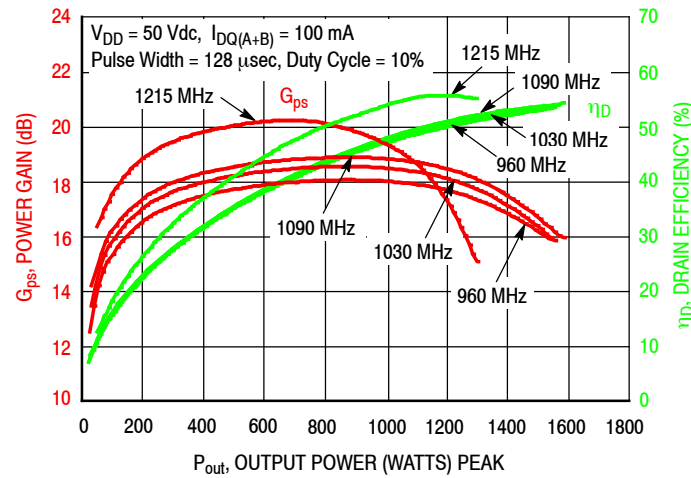

Figure 7. Power Gain and Drain Efficiency versus Output Power

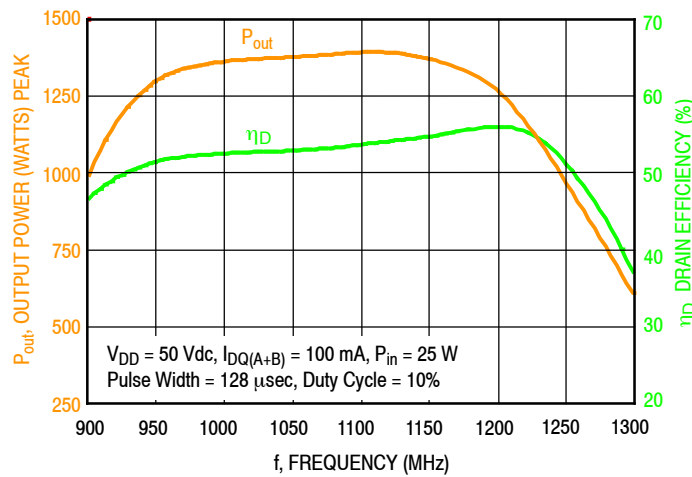
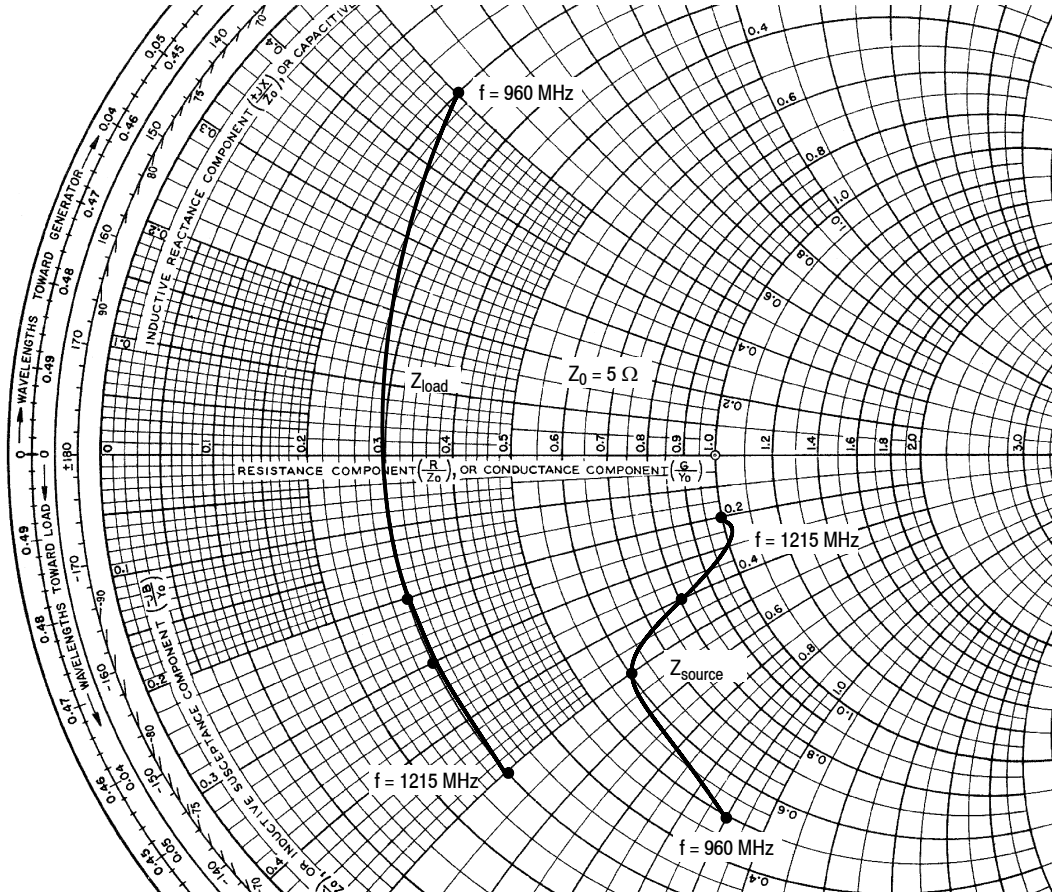

Figure 8. Output Power and Drain Efficiency versus Frequency at a Constant Input Power

960–1215 MHz REFERENCE CIRCUIT



f MHz	Z_{source} Ω	Z_{load} Ω
960	$2.3 - j4.3$	$1.7 - j2.3$
1030	$3.1 - j2.4$	$1.6 - j1.3$
1090	$3.9 - j2.0$	$1.4 - j0.8$
1215	$4.9 - j0.8$	$0.8 + j2.5$

Z_{source} = Test circuit impedance as measured from gate to gate, balanced configuration.

Z_{load} = Test circuit impedance as measured from drain to drain, balanced configuration.

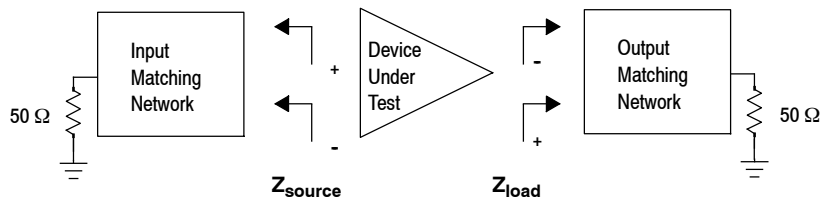

Figure 9. Series Equivalent Source and Load Impedance — 960–1215 MHz

1030 MHz NARROWBAND PRODUCTION TEST FIXTURE — 4" x 5" (10.16 cm x 12.70 cm)

Table 10. 1030 MHz Narrowband Performance ⁽¹⁾ $V_{DD} = 50$ Vdc, $I_{DQ(A+B)} = 100$ mA, $P_{out} = 1000$ W Peak (100 W Avg.)
 $f = 1030$ MHz, 128 μ sec Pulse Width, 10% Duty Cycle

Characteristic	Symbol	Min	Typ	Max	Unit
Power Gain	G_{ps}	18.5	19.6	22.0	dB
Drain Efficiency	η_D	55.5	59.7	—	%
Input Return Loss	IRL	—	-15	-9	dB

1. Measurements made with device in straight lead configuration before any lead forming operation is applied. Lead forming is used for gull wing (GN) parts.

Table 11. Load Mismatch/Ruggedness (In Freescale Narrowband Production Test Fixture, 50 ohm system) $I_{DQ(A+B)} = 100$ mA

Frequency (MHz)	Signal Type	VSWR	P_{in} (W)	Test Voltage, V_{DD}	Result
1030	Pulse (128 μ sec, 10% Duty Cycle)	> 20:1 at all Phase Angles	20.2 Peak (3 dB Overdrive)	50	No Device Degradation

1030 MHz NARROWBAND PRODUCTION TEST FIXTURE — 4" x 5" (10.16 cm x 12.70 cm)

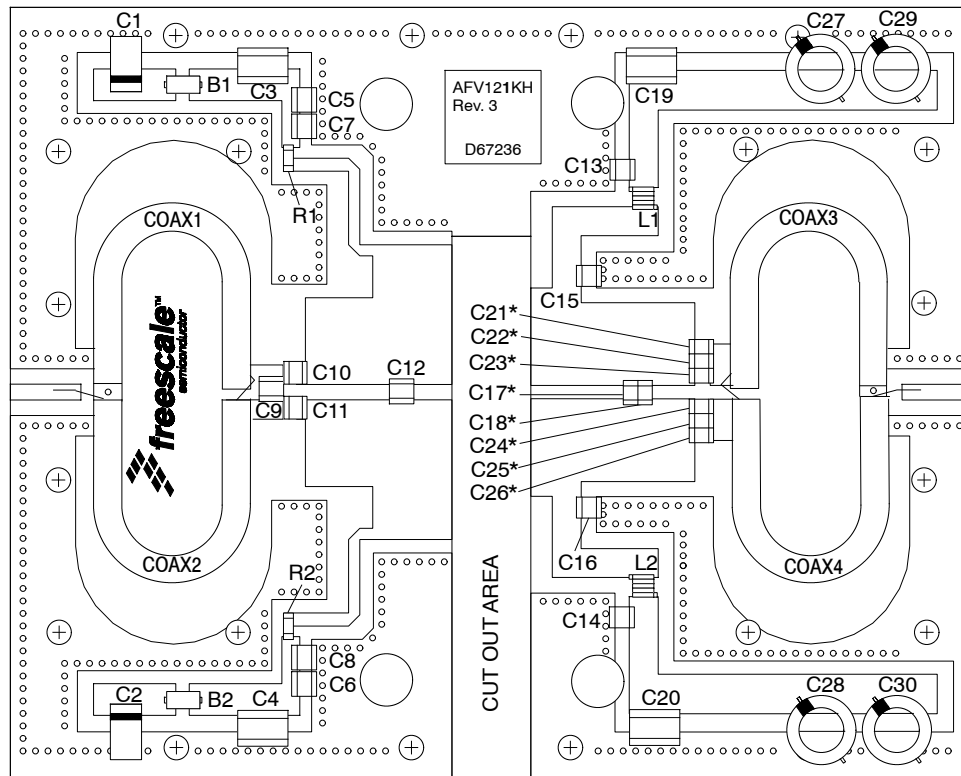

* C17, C18, C21, C22, C23, C24, C25 and C26 are mounted vertically.

Figure 10. AFV121KH(HS) Narrowband Test Circuit Component Layout — 1030 MHz

Table 12. AFV121KH(HS) Narrowband Test Circuit Component Designations and Values — 1030 MHz

Part	Description	Part Number	Manufacturer
B1, B2	Short RF Bead	2743019447	Fair-Rite
C1, C2	22 μ F, 35 V Tantalum Capacitors	T491X226K035AT	Kemet
C3, C4	2.2 μ F Chip Capacitors	C1825C225J5RACTU	Kemet
C5, C6	0.1 μ F Chip Capacitors	CDR33BX104AKWS	AVX
C7, C8	36 pF Chip Capacitors	ATC100B360JT500XT	ATC
C9	2.7 pF Chip Capacitor	ATC100B2R7CT500XT	ATC
C10, C11	30 pF Chip Capacitors	ATC100B300JT500XT	ATC
C12	8.2 pF Chip Capacitor	ATC100B8R2CT500XT	ATC
C13, C14	36 pF Chip Capacitors	ATC100B360JT500XT	ATC
C15, C16	7.5 pF Chip Capacitors	ATC100B7R5CT500XT	ATC
C17	4.7 pF Chip Capacitor	ATC100B4R7CT500XT	ATC
C18	4.3 pF Chip Capacitor	ATC100B4R3CT500XT	ATC
C19, C20	0.01 μ F Chip Capacitors	C1825C103K1GACTU	Kemet
C21, C22, C23, C24, C25, C26	43 pF Chip Capacitors	ATC100B430JT500XT	ATC
C27, C28, C29, C30	470 μ F, 63 V Electrolytic Capacitors	MCGPR63V477M13X26-RH	Multicomp
Coax1, Coax2, Coax3, Coax4	35 Ω Flex Cable 1.98"	HSF-141C-35	Hongsen Cable
L1, L2	12 η H, 3 Turn Inductors	GA3094-ALC	Coilcraft
R1, R2	1.1 k Ω , 1/4 W Chip Resistors	CRCW12061K10FKEA	Vishay
PCB	Arlon, AD255A, 0.03", $\epsilon_r = 2.55$	D67236	MTL

TYPICAL CHARACTERISTICS — 1030 MHz

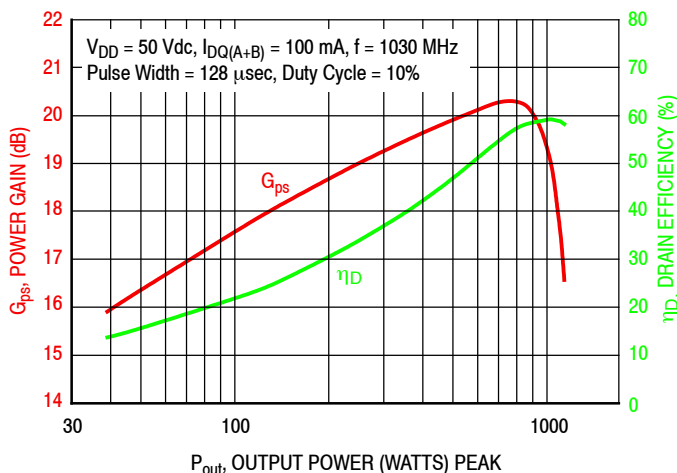
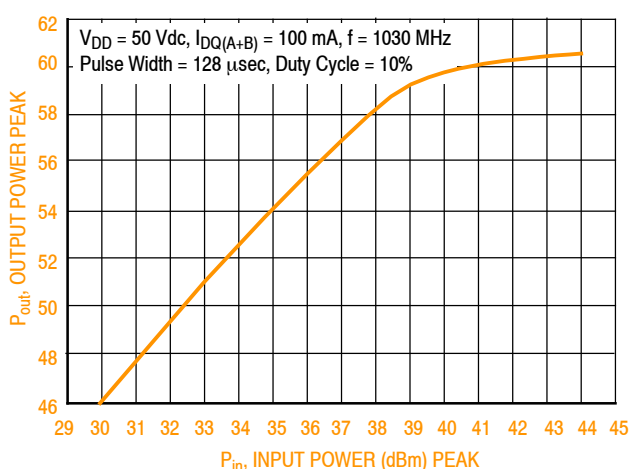

Figure 11. Power Gain and Drain Efficiency versus Output Power



f (MHz)	P1dB (W)	P3dB (W)
1030	1002	1115

Figure 12. Output Power versus Input Power

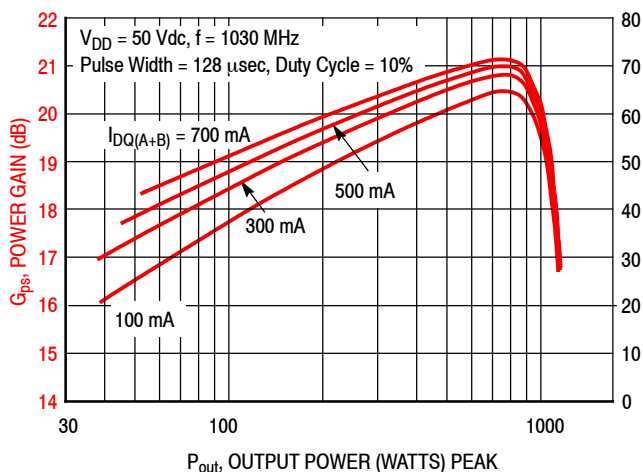

Figure 13. Power Gain versus Output Power

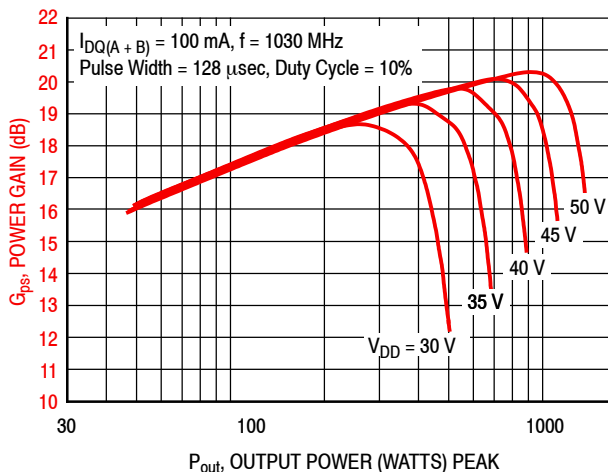

Figure 14. Power Gain versus Output Power

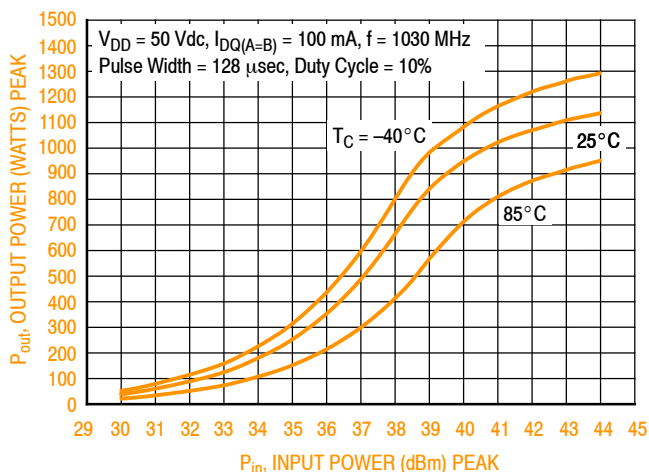

Figure 15. Output Power versus Input Power

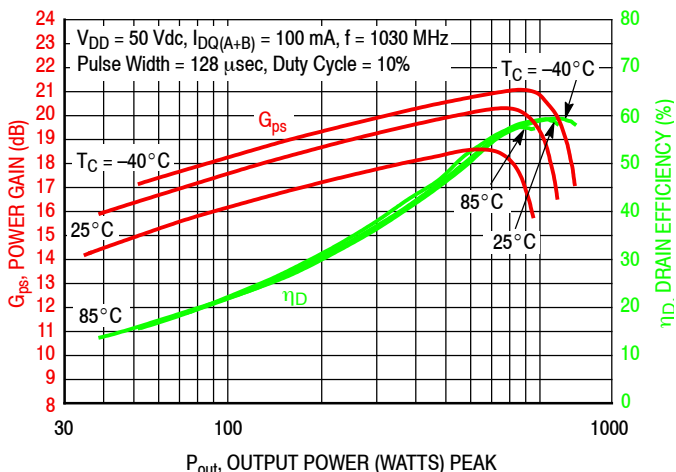

Figure 16. Power Gain and Drain Efficiency versus Output Power

AFV121KH AFV121KHS AFV121KGS

1030 MHz NARROWBAND PRODUCTION TEST FIXTURE

f MHz	Z_{source} Ω	Z_{load} Ω
1030	2.40 - j3.73	1.9 + j1.00

Z_{source} = Test circuit impedance as measured from gate to gate, balanced configuration.

Z_{load} = Test circuit impedance as measured from drain to drain, balanced configuration.

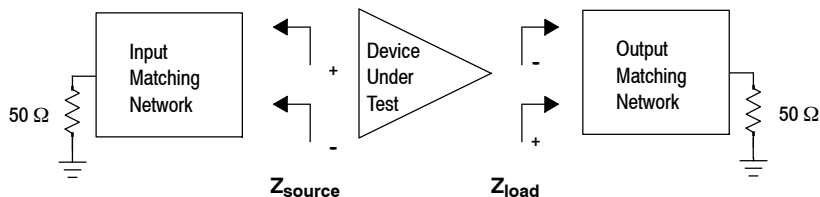
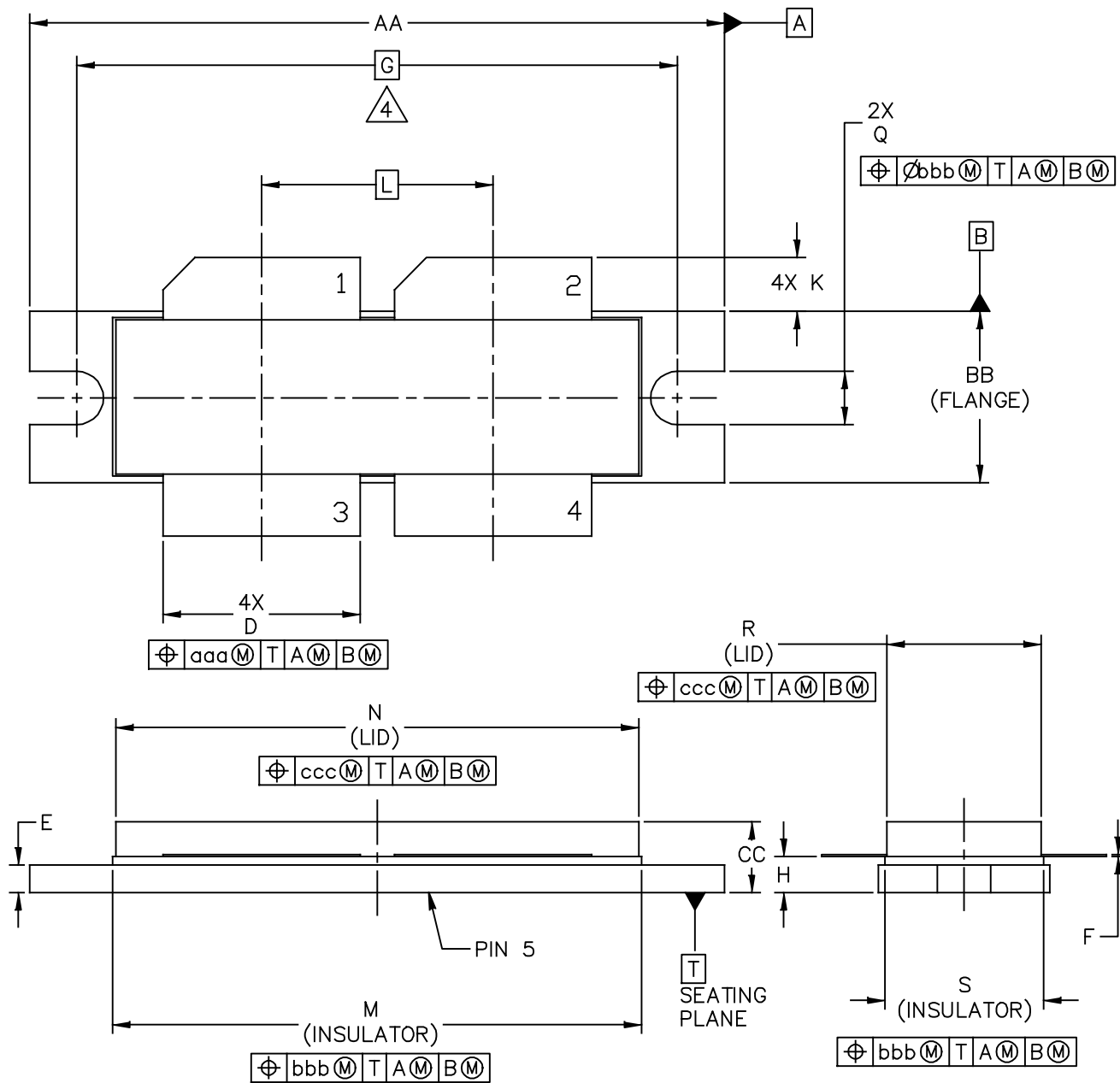

Figure 17. Narrowband Series Equivalent Source and Load Impedance — 1030 MHz

PACKAGE DIMENSIONS



© FREESCALE SEMICONDUCTOR, INC. ALL RIGHTS RESERVED.	MECHANICAL OUTLINE	PRINT VERSION NOT TO SCALE
TITLE: NI-1230-4H	DOCUMENT NO: 98ASB16977C REV: F	STANDARD: NON-JEDEC
28 FEB 2013		

NOTES:

1. INTERPRET DIMENSIONS AND TOLERANCES PER ASME Y14.5M-1994.
2. CONTROLLING DIMENSION: INCH
3. DIMENSION H IS MEASURED .030 INCH (0.762 MM) AWAY FROM PACKAGE BODY.

4. RECOMMENDED BOLT CENTER DIMENSION OF 1.52 INCH (38.61 MM) BASED ON M3 SCREW.

DIM	INCH		MILLIMETER		DIM	INCH		MILLIMETER	
	MIN	MAX	MIN	MAX		MIN	MAX	MIN	MAX
AA	1.615	1.625	41.02	41.28	N	1.218	1.242	30.94	31.55
BB	.395	.405	10.03	10.29	Q	.120	.130	3.05	3.30
CC	.170	.190	4.32	4.83	R	.355	.365	9.02	9.27
D	.455	.465	11.56	11.81	S	.365	.375	9.27	9.53
E	.062	.066	1.57	1.68					
F	.004	.007	0.10	0.18					
G	1.400 BSC		35.56 BSC		aaa	.013		0.33	
H	.082	.090	2.08	2.29	bbb	.010		0.25	
K	.117	.137	2.97	3.48	ccc	.020		0.51	
L	.540 BSC		13.72 BSC						
M	1.219	1.241	30.96	31.52					
© FREESCALE SEMICONDUCTOR, INC. ALL RIGHTS RESERVED.			MECHANICAL OUTLINE			PRINT VERSION NOT TO SCALE			
TITLE: NI-1230-4H					DOCUMENT NO: 98ASB16977C REV: F				
					STANDARD: NON-JEDEC				
					28 FEB 2013				

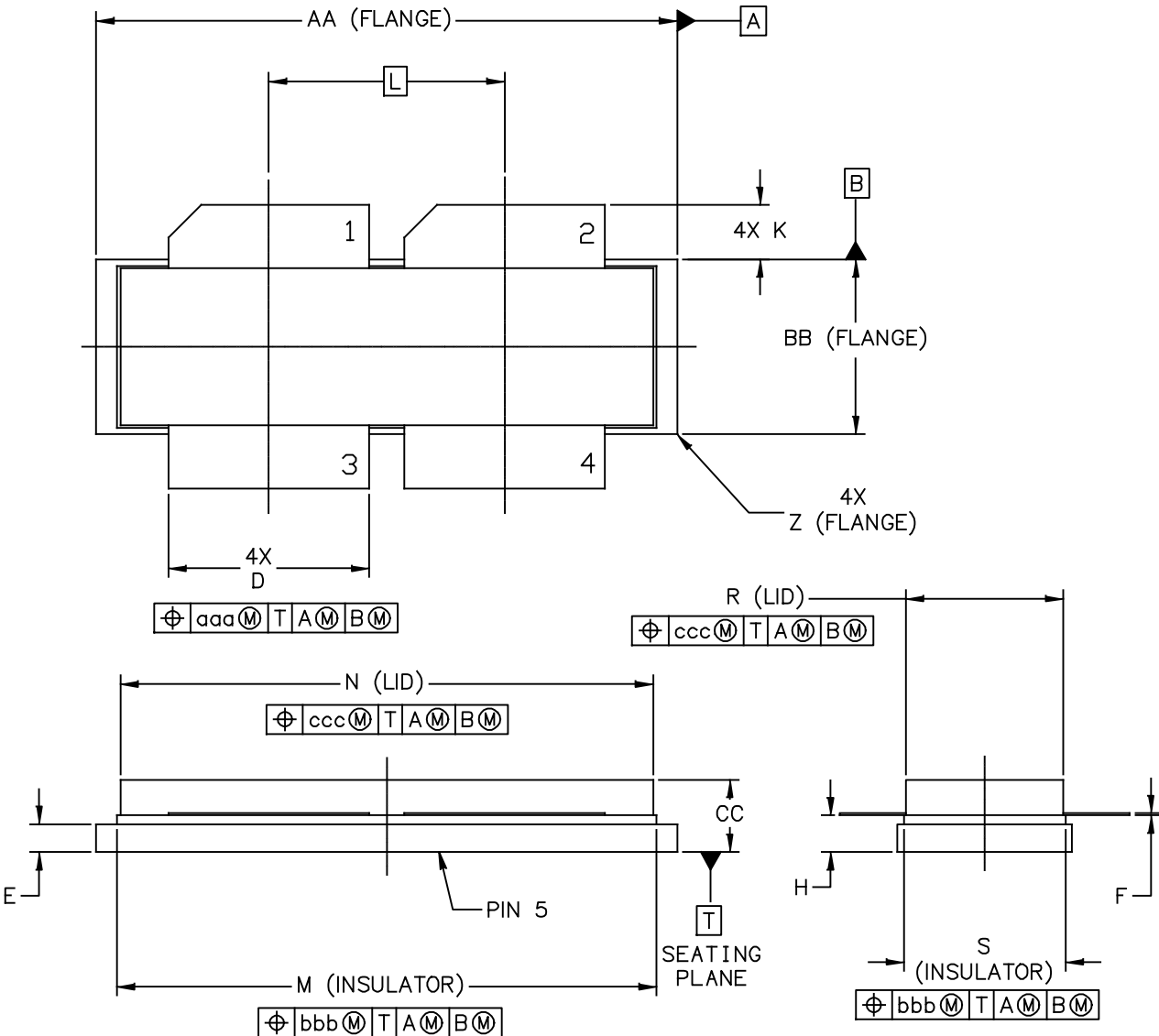

© FREESCALE SEMICONDUCTOR, INC. ALL RIGHTS RESERVED.	MECHANICAL OUTLINE	PRINT VERSION NOT TO SCALE
TITLE: NI-1230-4S	DOCUMENT NO: 98ARB18247C	REV: G
	STANDARD: NON-JEDEC	
	01 MAR 2013	

NOTES:

1. INTERPRET DIMENSIONS AND TOLERANCES PER ASME Y14.5M–1994.
2. CONTROLLING DIMENSION: INCH
3. DIMENSION H IS MEASURED .030 INCH (0.762 MM) AWAY FROM PACKAGE BODY

DIM	INCHES		MILLIMETERS		DIM	INCHES		MILLIMETERS	
	MIN	MAX	MIN	MAX		MIN	MAX	MIN	MAX
AA	1.265	1.275	32.13	32.39	R	.355	.365	9.02	9.27
BB	.395	.405	10.03	10.29	S	.365	.375	9.27	9.53
CC	.170	.190	4.32	4.83	Z	R.000	R.040	R0.00	R1.02
D	.455	.465	11.56	11.81					
E	.062	.066	1.57	1.68	aaa	.013		0.33	
F	.004	.007	0.10	0.18	bbb	.010		0.25	
H	.082	.090	2.08	2.29	ccc	.020		0.51	
K	.117	.137	2.97	3.48					
L	.540 BSC		13.72 BSC						
M	1.219	1.241	30.96	31.52					
N	1.218	1.242	30.94	31.55					
© FREESCALE SEMICONDUCTOR, INC. ALL RIGHTS RESERVED.			MECHANICAL OUTLINE			PRINT VERSION NOT TO SCALE			
TITLE: NI-1230-4S					DOCUMENT NO: 98ARB18247C REV: G				
					STANDARD: NON-JEDEC				
					01 MAR 2013				

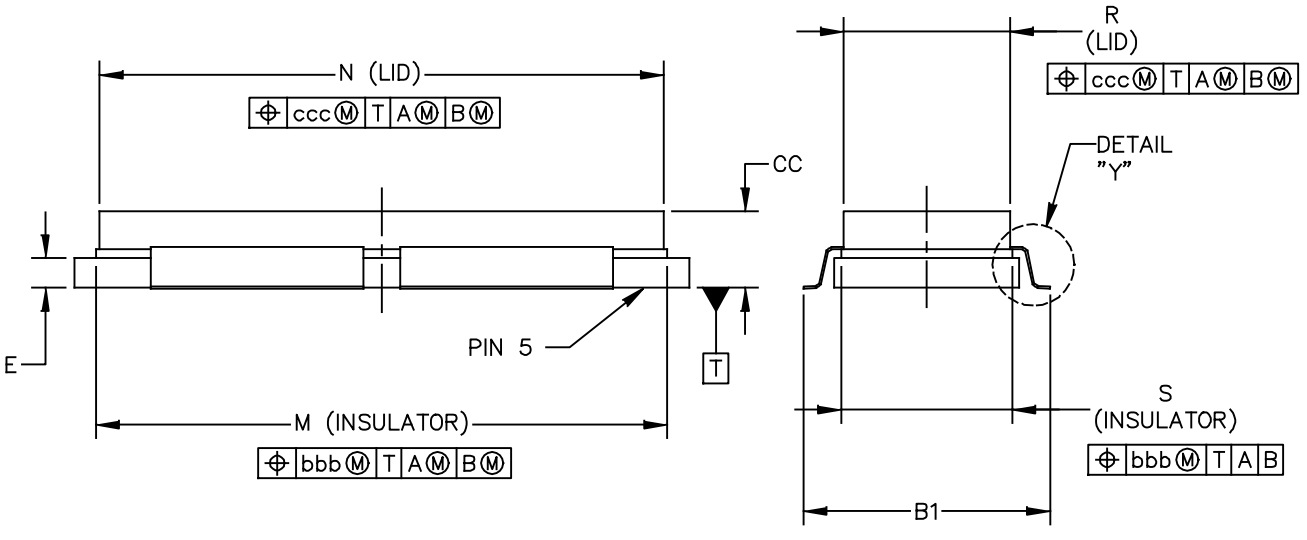
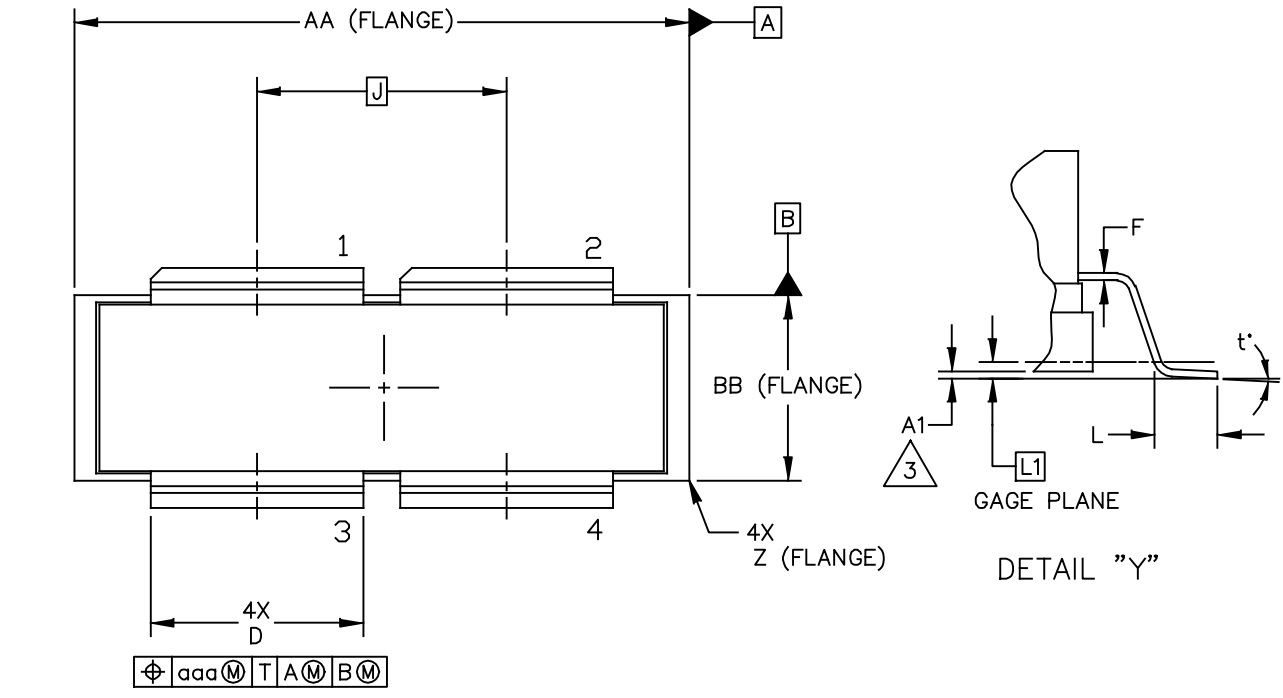

© FREESCALE SEMICONDUCTOR, INC. ALL RIGHTS RESERVED.	MECHANICAL OUTLINE	PRINT VERSION NOT TO SCALE
TITLE: NI-1230-4S GULL	DOCUMENT NO: 98ASA00459D	REV: A
	STANDARD: NON-JEDEC	
	07 MAR 2013	

NOTES:

1. INTERPRET DIMENSIONS AND TOLERANCES PER ASME Y14.5M-1994.

2. CONTROLLING DIMENSION: INCH

3. DIMENSION A1 IS MEASURED WITH REFERENCE TO DATUM T. THE POSITIVE VALUE IMPLIES THAT THE PACKAGE BOTTOM IS HIGHER THAN THE LEAD BOTTOM.

DIM	INCHES		MILLIMETERS		DIM	INCHES		MILLIMETERS	
	MIN	MAX	MIN	MAX		MIN	MAX	MIN	MAX
AA	1.265	1.275	32.13	32.39	R	.355	.365	9.02	9.27
A1	-.001	.011	-0.03	0.28	S	.365	.375	9.27	9.53
BB	.395	.405	10.03	10.29	Z	R.000	R.040	R0.00	R1.02
B1	.564	.574	14.32	14.58	t'	0'	8'	0'	8'
CC	.170	.190	4.32	4.83					
D	.455	.465	11.56	11.81	aaa	.013		0.33	
E	.062	.066	1.57	1.68	bbb	.010		0.25	
F	.004	.007	0.10	0.18	ccc	.020		0.51	
J	.540 BSC		13.72 BSC						
L	.038	.046	0.97	1.17					
L1	.01 BSC		0.25 BSC						
M	1.219	1.241	30.96	31.52					
N	1.218	1.242	30.94	31.55					
© FREESCALE SEMICONDUCTOR, INC. ALL RIGHTS RESERVED.			MECHANICAL OUTLINE			PRINT VERSION NOT TO SCALE			
TITLE: NI-1230-4S GULL					DOCUMENT NO: 98ASA00459D REV: A				
					STANDARD: NON-JEDEC				
					07 MAR 2013				

Refer to the following resources to aid your design process.

Application Notes

- AN1908: Solder Reflow Attach Method for High Power RF Devices in Air Cavity Packages
- AN1955: Thermal Measurement Methodology of RF Power Amplifiers

Engineering Bulletins

- EB212: Using Data Sheet Impedances for RF LDMOS Devices

Software

- Electromigration MTTF Calculator
- RF High Power Model
- .s2p File

Development Tools

- Printed Circuit Boards

To Download Resources Specific to a Given Part Number:

1. Go to <http://www.freescale.com/rf>
2. Search by part number
3. Click part number link
4. Choose the desired resource from the drop down menu

REVISION HISTORY

The following table summarizes revisions to this document.

Revision	Date	Description
0	Nov. 2015	• Initial Release of Data Sheet