



TAOGLAS®



Datasheet

25mm 2 Stage GNSS Active Patch

Part No:
AGGP.25F.07.0060A

Description:

25mm Two Stage GPS-GLONASS-GALILEO GNSS Active Patch Antenna Module with Front-End Saw Filter

Features:

Industry leading GPS-GLONASS-GALILEO antenna performance

25.1*25.1*7.4mm (Ground Plane)

Connector: IPEX MHFI (U.FL)

Cable: 60mm of \varnothing 1.13mm coax

28dB LNA

Wide Input Voltage 1.8V to 5.5V

Low Power Consumption

RoHS & Reach Compliant

1. Introduction	3
2. Specifications	4
3. LNA Characteristics	6
4. Radiation Patterns	8
5. Mechanical Drawing	10
6. Usage Precautions	11
7. Packaging	12
<hr/>	
Changelog	13

Taoglas makes no warranties based on the accuracy or completeness of the contents of this document and reserves the right to make changes to specifications and product descriptions at any time without notice. Taoglas reserves all rights to this document and the information contained herein. Reproduction, use or disclosure to third parties without express permission is strictly prohibited.



1. Introduction



The AGGP.25F GPS/GLONASS/GALILEO GNSS active patch antenna (along with the AGGP.35 model) is the best choice to use as an embedded antenna with the latest generation of GPS/GLONASS/GALILEO GNSS receivers. It utilizes a 25.1*25.1*4mm advanced wide-band ceramic patch antenna with optimized gain, radiation pattern and axial ratio at GPS, GLONASS and GALILEO centre frequencies.

The AGGP.25F also includes a two stage LNA and a front-end SAW filter to reduce out of band noise such as from nearby cellular transceiver, and improve probability of the wireless device passing radiated spurious emissions certification. Produced in TS16949 automotive quality approved facility and 100% tested for gain (S21), return loss (S11) to ensure total consistency of performance.

Cable type, length and connectors can be customized and samples offered according to requirement, subject to minimum order quantities in production. Taoglas also offers custom tuning service based on minimum order quantities, contact your local regional sales office for details.

The AGGP.25F consists of 2 functional blocks – the LNA and also the patch antenna.

2. Specifications

GNSS Frequency Bands Covered							
GPS/QZSS	L1 1575.42MHz	L2 1227.6MHz	L5 1176.45MHz	L6 1278.75MHz			
	■	□	□	□			
GLONASS	L5R 1176.45MHz	L3PT 1201.5MHz	L2PT 1246MHz	L1CR 1575.42MHz	L1PT 1602MHz		
	□	□	□	■	■		
Galileo	E5a 1176.45MHz	E5b 1201.5MHz	E4 1215MHz	E3 1256MHz	E6 1278.75MHz	E2 1561MHz	L1 1575.42MHz
	□	□	□	□	□	□	■
BeiDou	B1 1561MHz	B2 1207.14MHz	B3 1268.52MHz				
	□	□	□				
Compass	E5B(B2)/ E6(B3) 1268.56MHz	E2(B1) 1561MHz					
	□	□					
SBAS	Omnistar 1542.5MHz	WAAS/EGN OS 1575.42MHz					
	□	■					

GNSS Electrical		
Frequency (MHz)	1575.42	1602
Gain at zenith (dBic)	1.5	0
Gain at 90° (dBic)	26.5	28
Axial Ratio at zenith (dB)	< 3	< 3
Polarization	RHCP	
Impedance	50Ω	

LNA and Filter Electrical Properties		
Frequency (MHz)	1575.42	1602
VSWR (max.)	2	2
Gain@1.8V (Typ.)	22dB	22dB
Gain@3.0V (Typ.)	28dB	28dB
Gain@5.5V (Typ.)	31dB	31dB
Noise@1.8V (Typ.)	2.6dB	2.6dB
Noise@3.0V (Typ.)	2.6dB	2.6dB
Noise@5.5V (Typ.)	2.9dB	2.9dB
Power consumption@1.8V (Typ.)	5mA	
Power consumption@3.0V (Typ.)	10mA	
Power consumption@5.5V (Typ.)	23mA	
Outer Band Attenuation	1592±140MHz 15dB min.	
Pout at 1dB Gain Compression point	Typ. -2dBm Min. -6dBm	

Mechanical	
Dimensions	25.1*25.1*7.4mm
Cable	60mm of Ø1.13
Connector	IPEX MHFI
Weight	13g
Temperature Range	-40°C to 85°C
Humidity	Non-condensing 65°C 95% RH

3. LNA Characteristics

3.1 Block Diagram (Active Antenna)

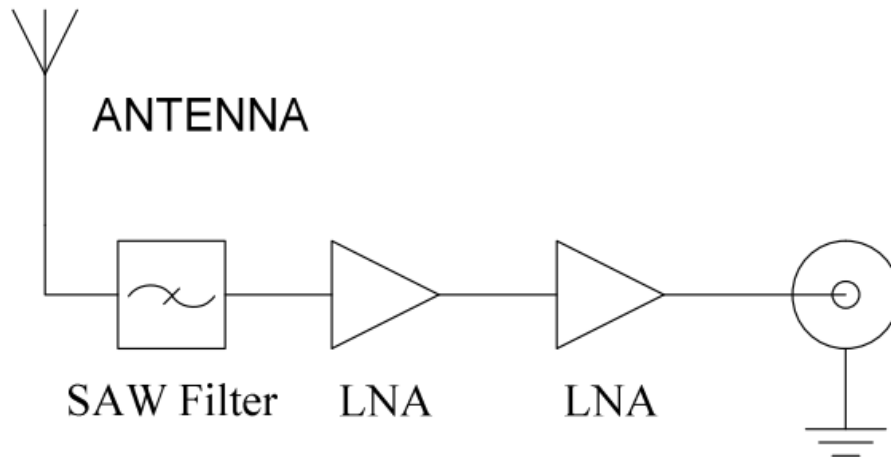

3.2 LNA Gain

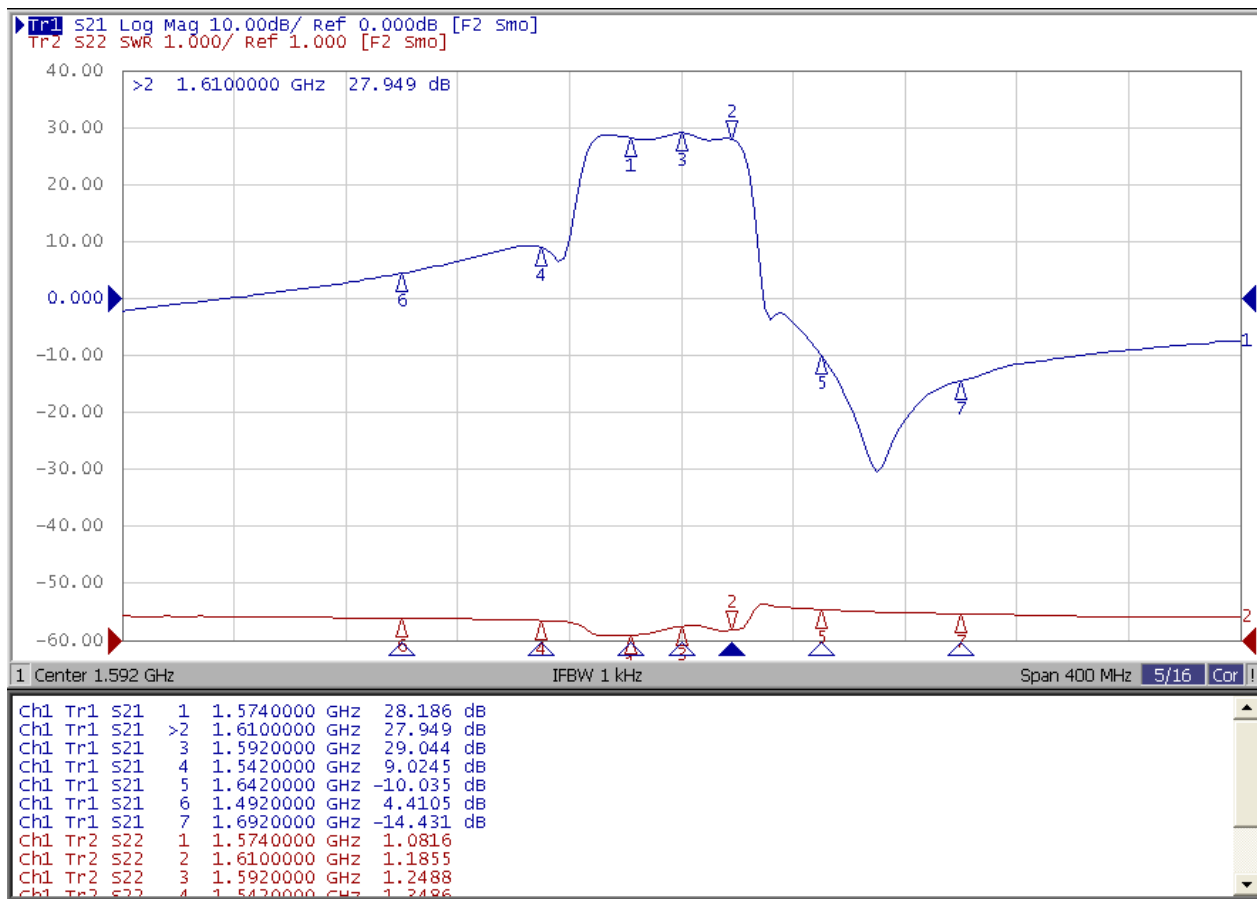

3.3 Noise Figure @3.0V

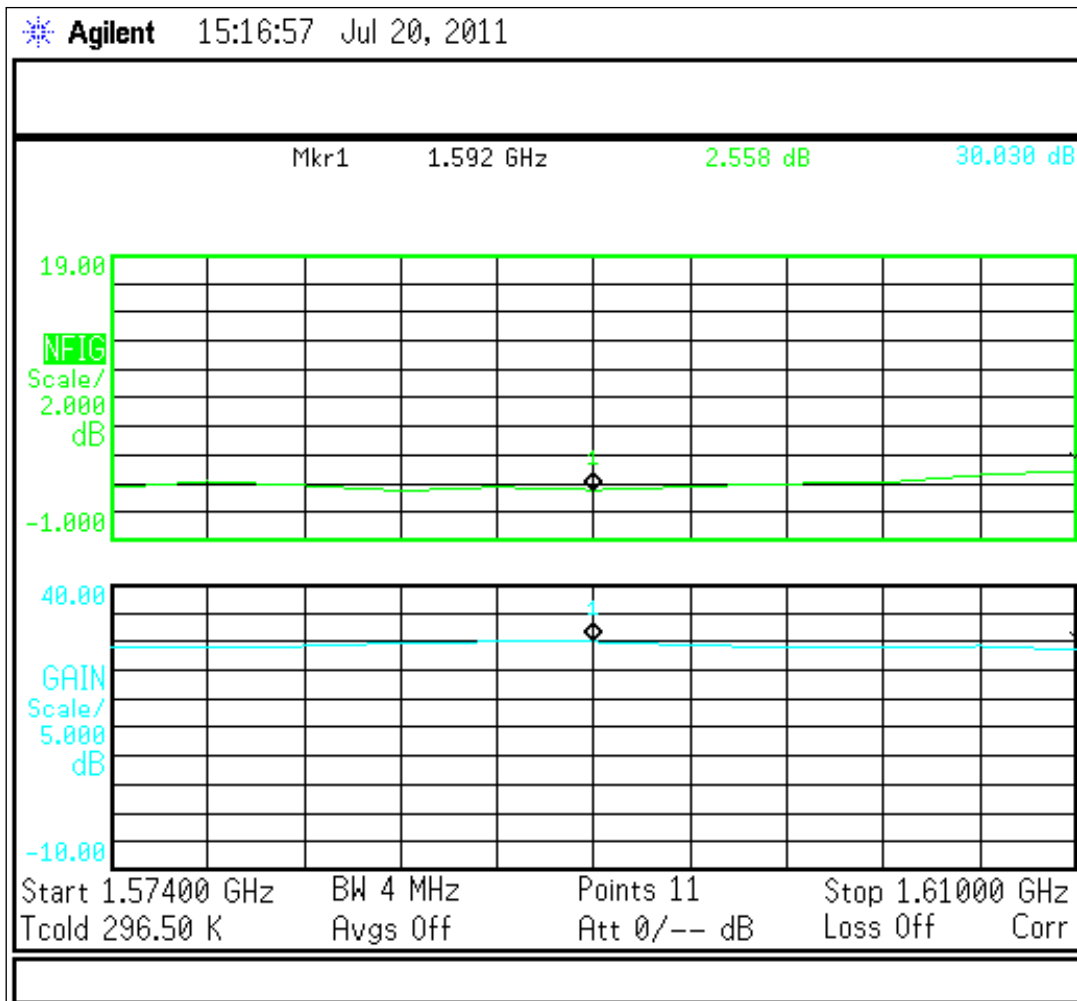

4. Radiation Patterns

4.1 1575.42MHz 2D Radiation Patterns

XZ & XY Plane

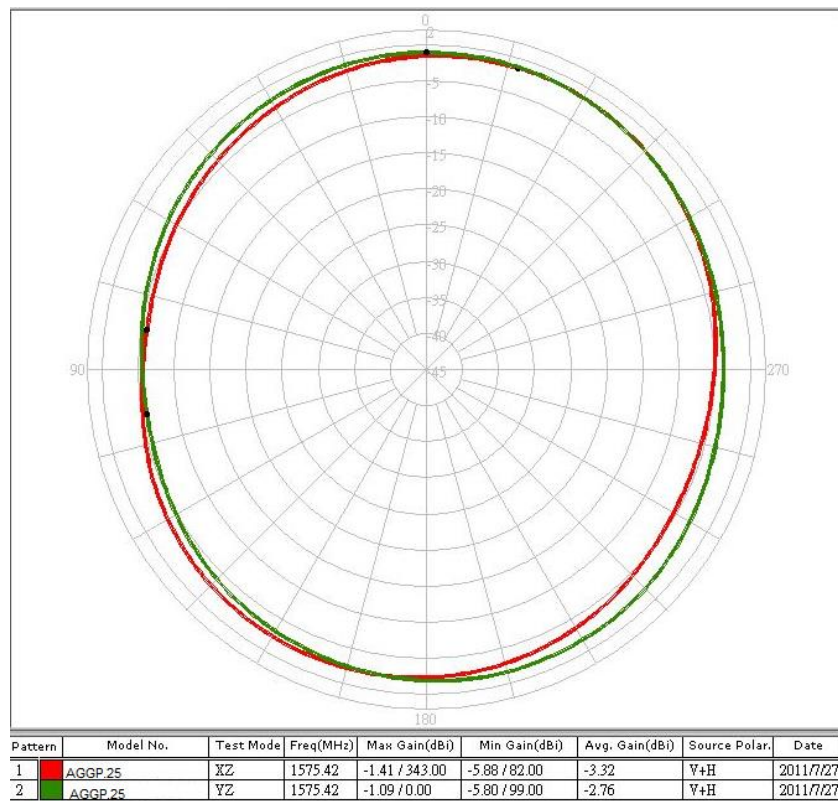

4.2 1602MHz 2D Radiation Patterns

XZ & XY Plane

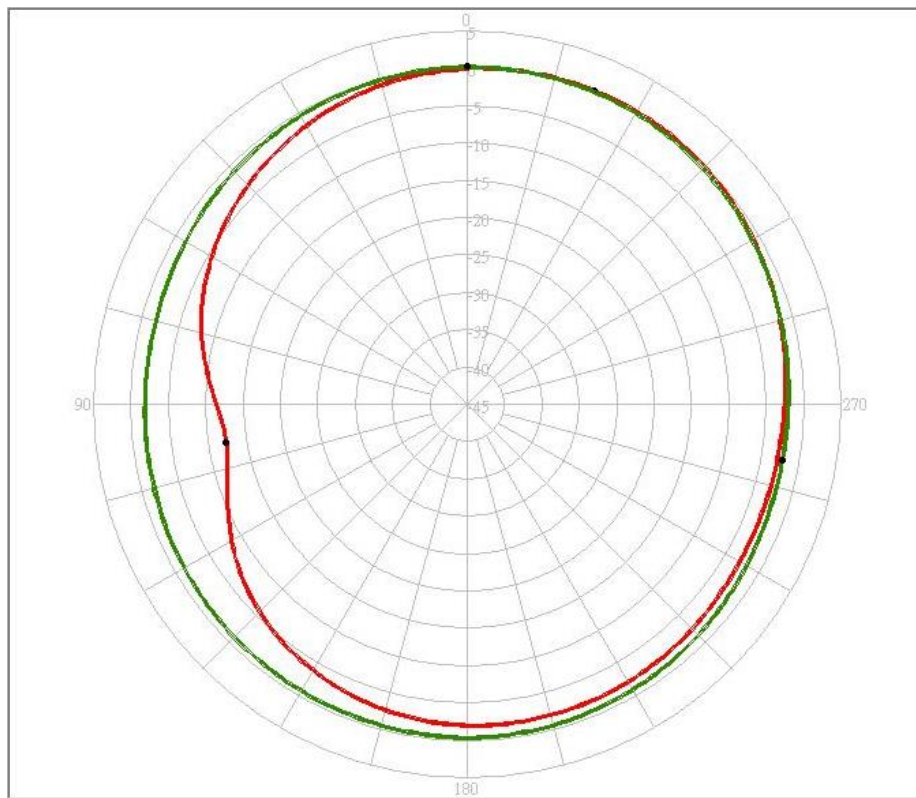

Pattern	Model No.	Test Mode	Freq(MHz)	Max Gain(dBi)	Min Gain(dBi)	Avg. Gain(dBi)	Source Polar.	Date
1	AGGP.25	XZ	1602.00	0.28 / 338.00	-12.36 / 99.00	-2.49	V+H	2011/8/1
2	AGGP.25	YZ	1602.00	0.19 / 0.00	-2.17 / 260.00	-0.91	V+H	2011/8/1

5. Mechanical Drawing (Units: mm)

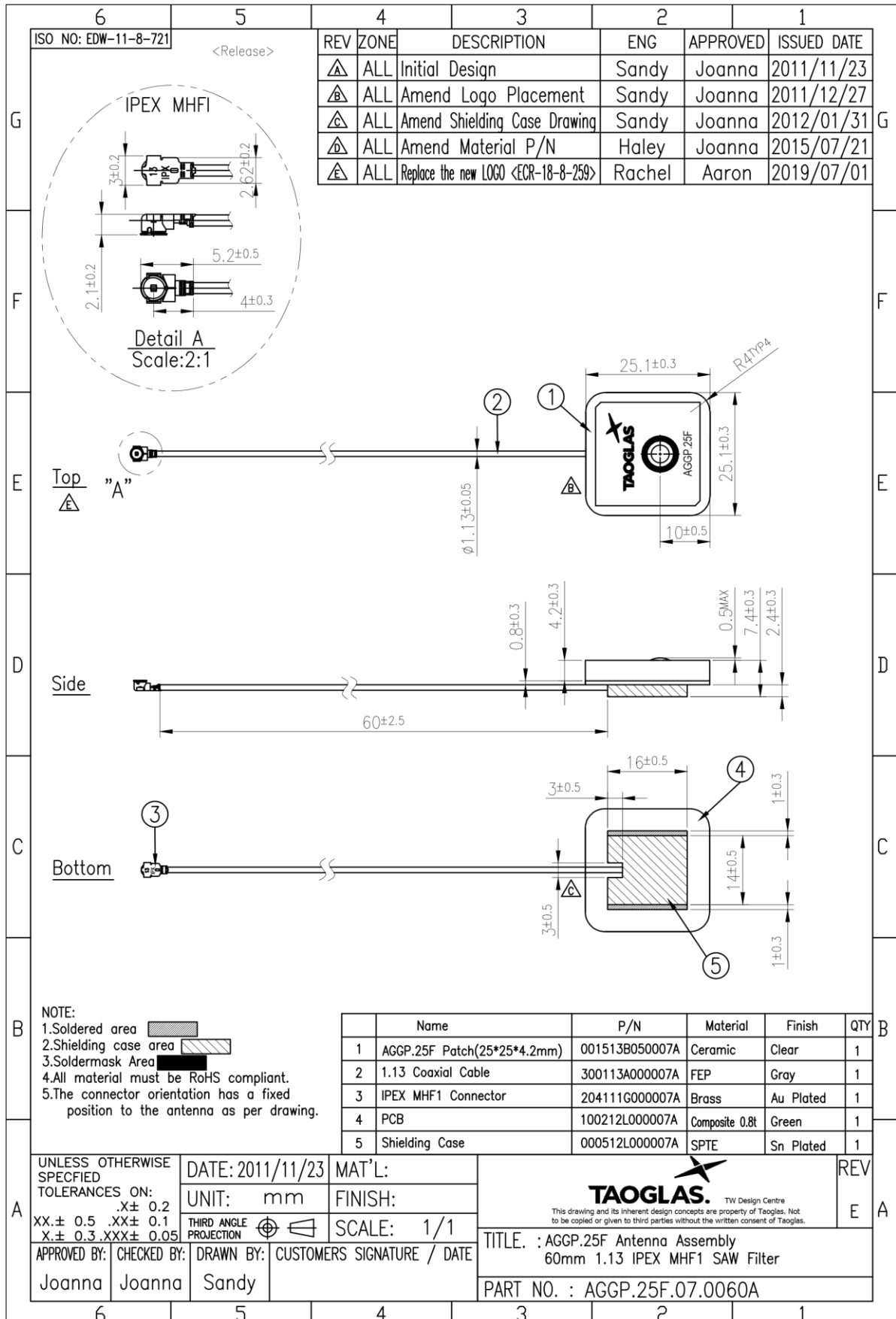

6. Usage Precautions

6.1 Mating/Unmating

(1) To disconnect connectors, insert the end portion of I-PEX under the connector flanges and pull off vertically, in the direction of the connector mating axis.

(2) To mate the connectors, the mating axes of both connectors must be aligned and the connectors can be mated. The "click" will confirm fully mated connection. Do not attempt to insert on an extreme angle.

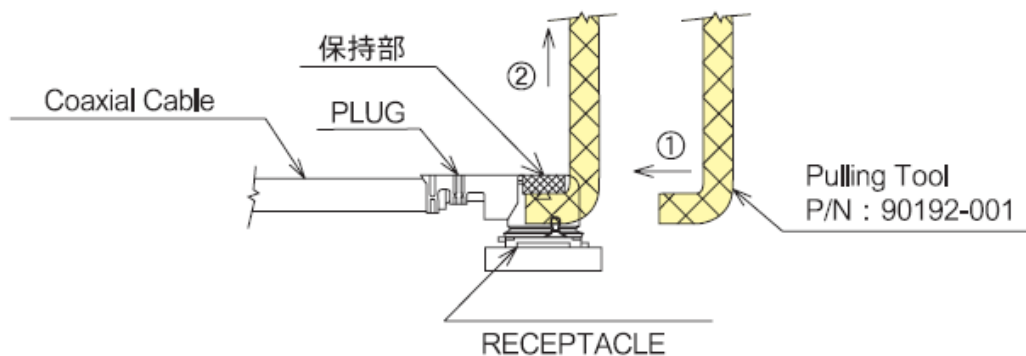

6.2 Pull forces on the cable after connectors are mated

After the connectors are mated, do not apply a load to the cable in excess of the values indicated in the diagram below.

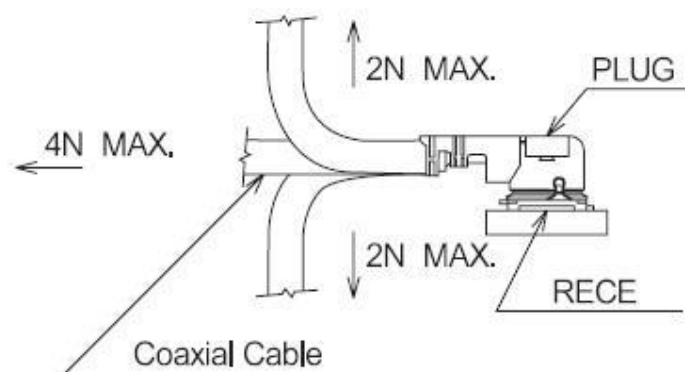

7. Packaging

60pcs AGGP.25F.07.0060A per Tray

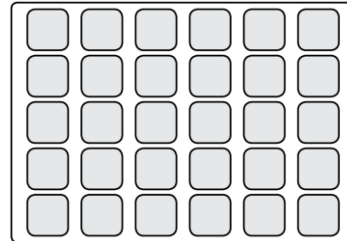

360pcs AGGBP.SL.18A.07.0060A per PE Bag

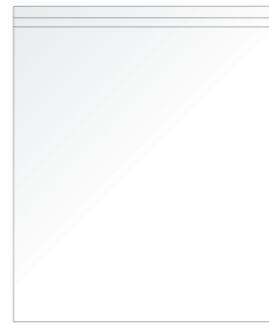

540pcs AGGP.25F.07.0060A per carton

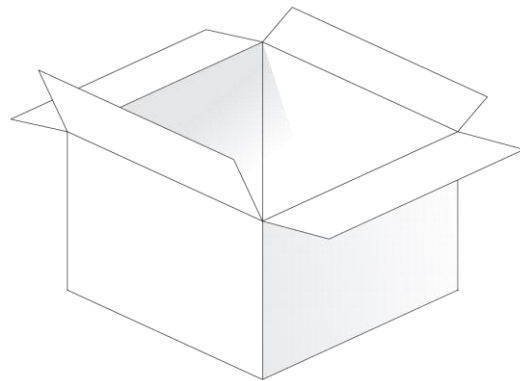

Changelog for the datasheet

SPE-12-8-015 – AGGP.25F.07.0060A

Revision: C (Current Version)

Date:	2019-10-24
Changes:	Updated new Template and drawing
Changes Made by:	Jack Conroy

Previous Revisions

Revision: B

Date:	2012-02-21
Changes:	Packaging Details Updated
Changes Made by:	Aine Doyle

Revision: A (Original First Release)

Date:	2012-02-14
Notes:	
Author:	Aine Doyle