



TAOGLAS®



Datasheet

Part No:
AGPSF.36G.07.0100C

Description:

Embedded Active GNSS L1/L2 Stacked Patch Antenna with 100mm 1.37 coax cable and IPEX MHFHT

Features:

Covers:

- GPS/QZSS (L1/L2)
- GLONASS (G1/G3)
- BeiDou (B1/B2b)
- Galileo (E1/E5b)

Low Noise Figure and Low Axial Ratio

Excellent Out-Of-Band Rejection

2 Stage LNA and SAW filter

Cable: 100mm 1.37 Coaxial Cable

Connector: I-PEX MHF®HT (U.FL Compatible)

Dimensions: 35*35*11.1mm

RoHS and REACH Compliant

1. Introduction	3
2. Specifications	4
3. Antenna Characteristics	6
4. Radiation Patterns	16
5. Field Test Results	23
6. Mechanical Drawing	24
7. Packaging	25
8. Application Note	26
<hr/>	
Changelog	27

Taoglas makes no warranties based on the accuracy or completeness of the contents of this document and reserves the right to make changes to specifications and product descriptions at any time without notice. Taoglas reserves all rights to this document and the information contained herein. Reproduction, use or disclosure to third parties without express permission is strictly prohibited.



1. Introduction



The Taoglas AGPSF.36G, with Taoglas Sure Technology, is an active, embedded stacked patch, GNSS antenna supporting both constellations at L1 and L2 bands. It is a high performance, economical solution for the highest accuracy centimeter-level tracking applications and is fully compatible with the next generation of GNSS L1/L2 receivers

Typical applications include:

- UAVs and Robotics
- E-Mobility and E-Scooters
- Precision Agriculture
- Navigation

This compact antenna exhibits excellent radiation patterns on L1 and L2 bands and with a low noise figure to preserve signal quality helps minimize time to first fix. It also features excellent out-of-band rejection to prevent out-of-band signals from overdriving or damaging its LNAs.

The AGPSF.36G features very tight Phase Centre Offset (PSO) at just $\pm 2\text{cm}$ at the L1 Band and $\pm 5\text{cm}$ at the L2. The precision of antenna phase center directly affects the accuracy of GNSS positioning systems and can ensure that the accuracy of the receiver really is cm level. See section 3.1.2 for more information and results.

This antenna has been tuned and tested on a 70 X 70 mm ground plane, working at GPS L1, 1575.42 MHz and L2, 1227.6MHz, with a 2 stage LNA ensuring good signal strength. It can operate with an input voltage ranging from 1.8 to 5 volts.

Cables and connectors are customizable. Patch antennas can also be tuned to customer-specific device environments, subject to NRE and MOQ. Contact your regional Taoglas customer support team to request these services or additional support to integrate and test this antenna's performance in your device.

GPS L1 & L2 Antenna						
Frequency	GPS_L2 1207-1239	GLONASS_G2 1241-1248	BeiDou_B1 1559-1563	Galileo_E1 1563-1587	GPS_L1 1564-1587	GLONASS 1593-1610
Average Gain (dB)	-2	-3.2	-4.4	-1.6	-1.6	-4.4
Efficiency (%)	63.2	47.5	36.3	69.1	69.1	36.1
Peak Gain (dBi)	4.2	3.2	0.9	3.7	3.7	0.8
Axial Ratio at Zenith	13.7	22.2	17.4	8.6	6.6	19.1
Impedance	50 Ω					
Polarization	RHCP					

*Tested on 70x70 cm ground plane

LNA and Filter Electrical Properties		
		3V (Typ.)
LNA Gain	L2	19.6
	L1	22.6
Noise Figure	L1	3.8
	L2	2.4
Current Consumption	16.8mA	
Outer Band Attenuation (dB)	30 @ Fc +/-100MHz 40 @ Fc +/-200MHz	
Output Impedance	50 Ohm	
Return loss (dB)	<-10 dB	
Input Voltage (V)	+ 1.8 to 5.5	

Mechanical	
Dimensions	35x35x11mm
Cable	Coaxial Cable Ø1.37, length 100mm
Connector	I-PEX MHF®HT (U.FL)
Weight	32g

Environmental	
Operation Temperature	-40°C to 85°C
Storage Temperature	-40°C to 85°C
Humidity	Non-condensing 40°C 95% RH
RoHS Compliant	Yes
REACH Compliant	Yes

3. Antenna Characteristics

3.1 Block Diagram (Active Antenna)

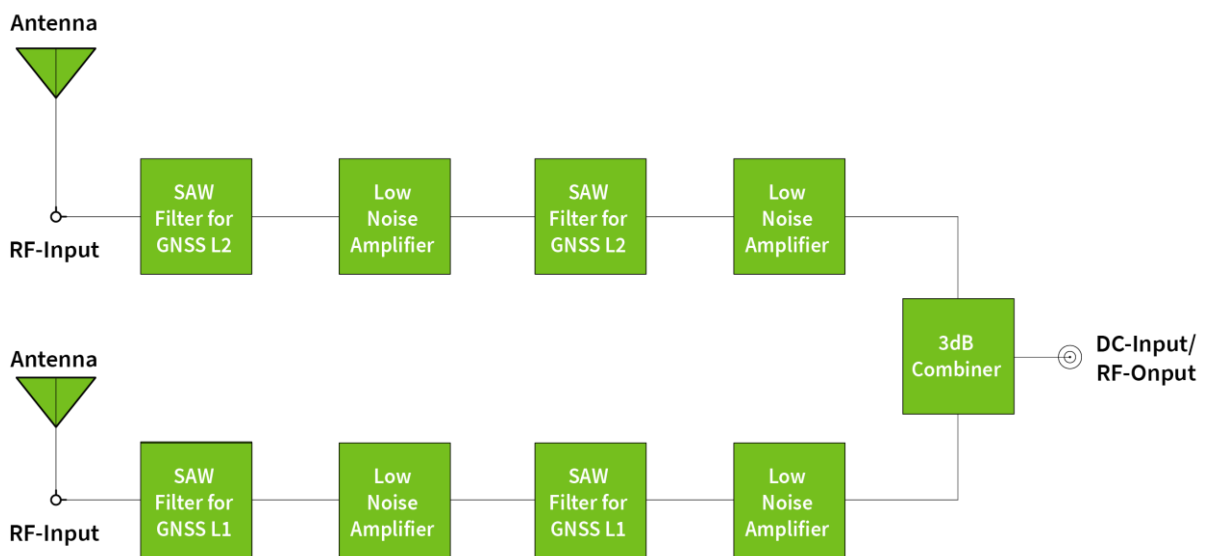

3.2 Phase Centre Offset

The antenna reference point (ARP) is defined as the intersection of antenna’s vertical axis of symmetry with the bottom of the antenna. The antenna reference point is typically the point on the center-line of the antenna at the mounting surface. Above the antenna reference point is the mechanical antenna phase center, this is the physical point on the surface of the antenna element where the antenna phase is located. The actual antenna phase center are points in space, typically above the mechanical antenna phase center.

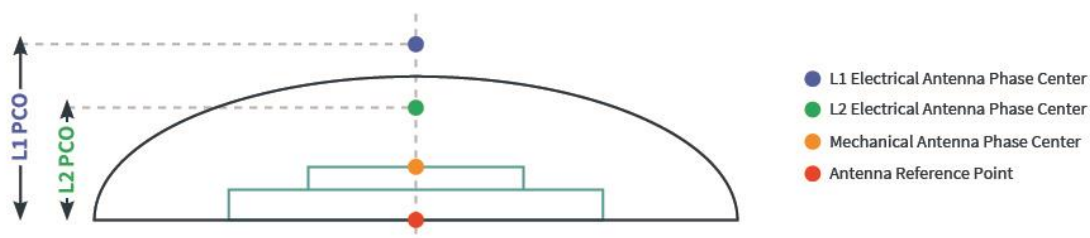

The precision of antenna phase center directly affects accuracy of GNSS positioning systems. Single-band and dual-band RTK GNSS receiver systems depend on Phase Centre Offset (PCO) correction input at the receiver to improve accuracy of the receiver to cm level. Thus PCO data is required for GPS post processing at the receiver in real time or at a later stage using post processing software once data has been transferred to a PC.

By using the carrier phase data of L1 and L2 signals, cm level precision is possible with PCO correction. Single-band and dual-band RTK systems depend on PCO correction input at the receiver to improve accuracy of the receiver to cm level.

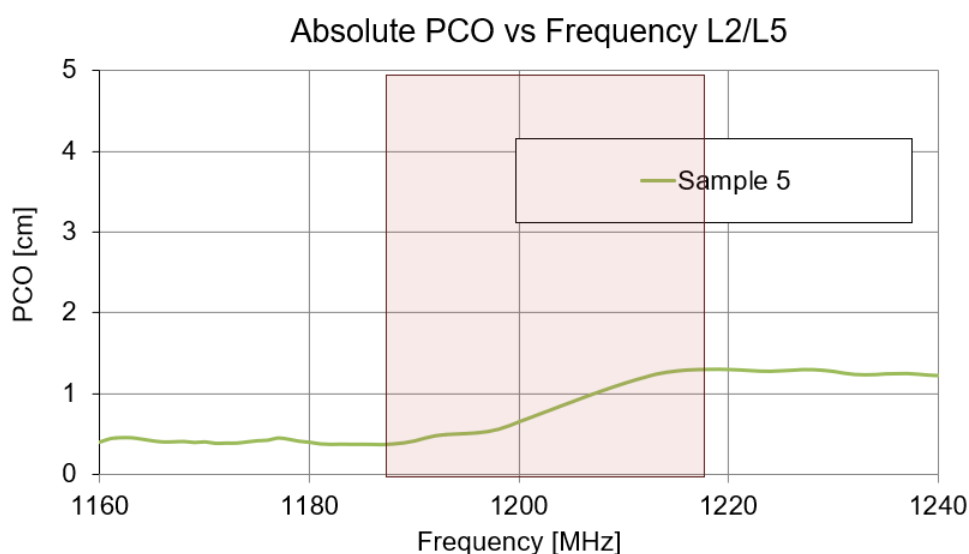
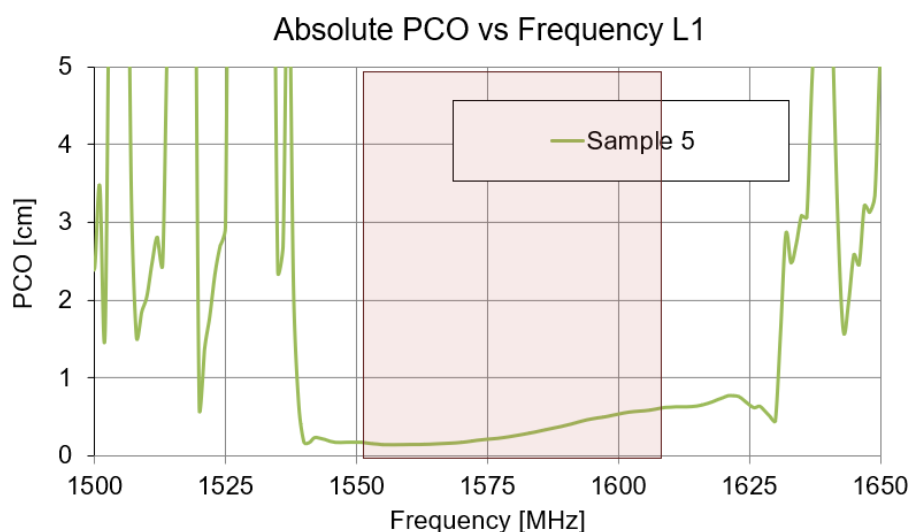

In addition to phase center location, the residual error is the mean of the difference between actual observed phase center and the predicted values. The smaller the residual error (typically less than 2 degrees) the better accuracy of the antenna due to good phase stability.

AGPSF.36C.07.0100C L1 Phase Centre Variation

PCV vs Frequency L1

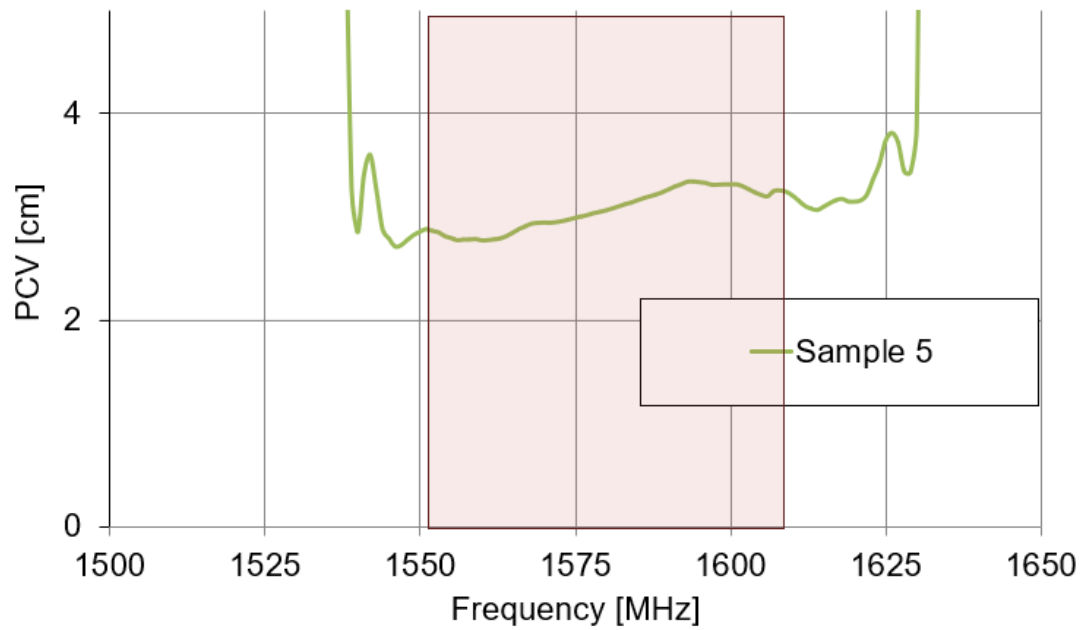

AGPSF.36C.07.0100A L2 Phase Centre Variation

PCV vs Frequency L2/L5

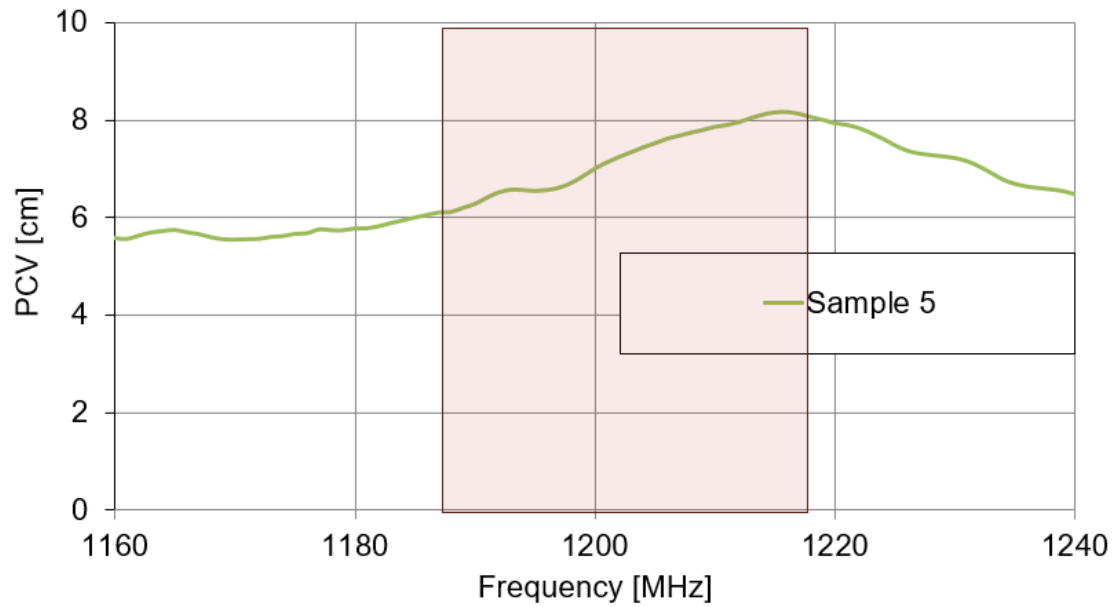

3.3 Return Loss

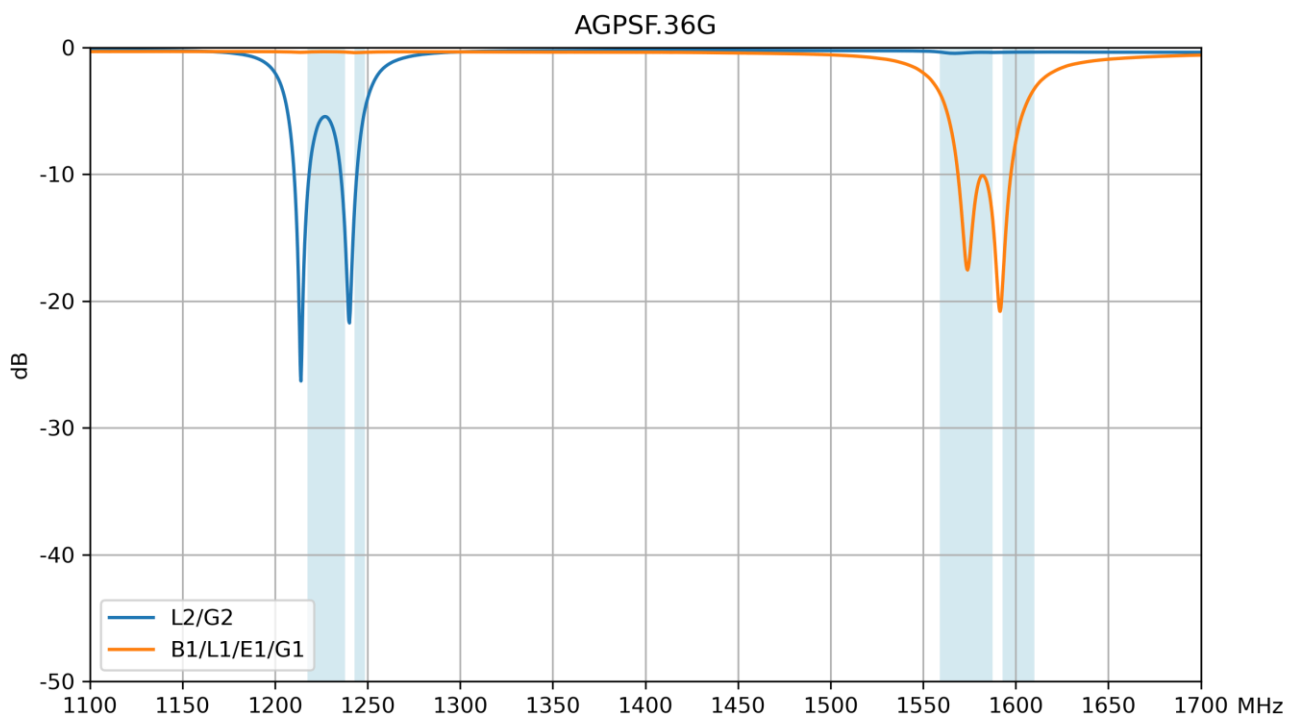

3.4 VSWR

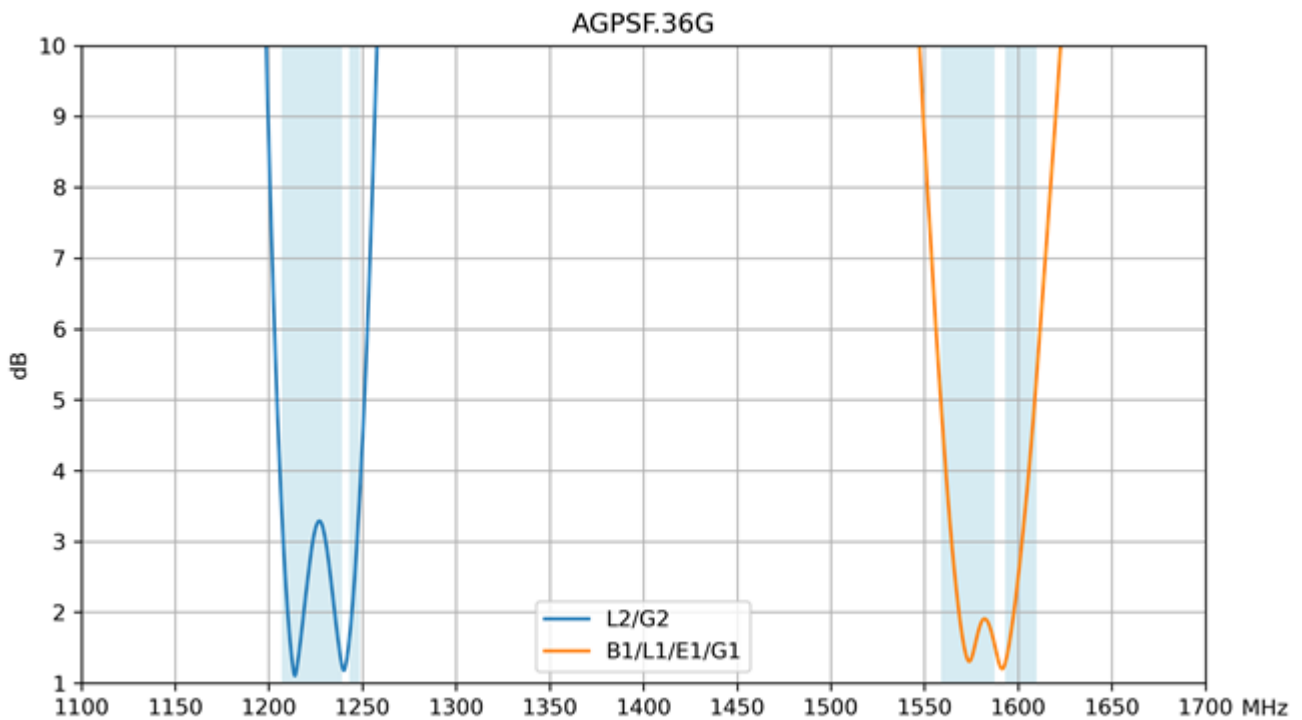

3.5 Efficiency

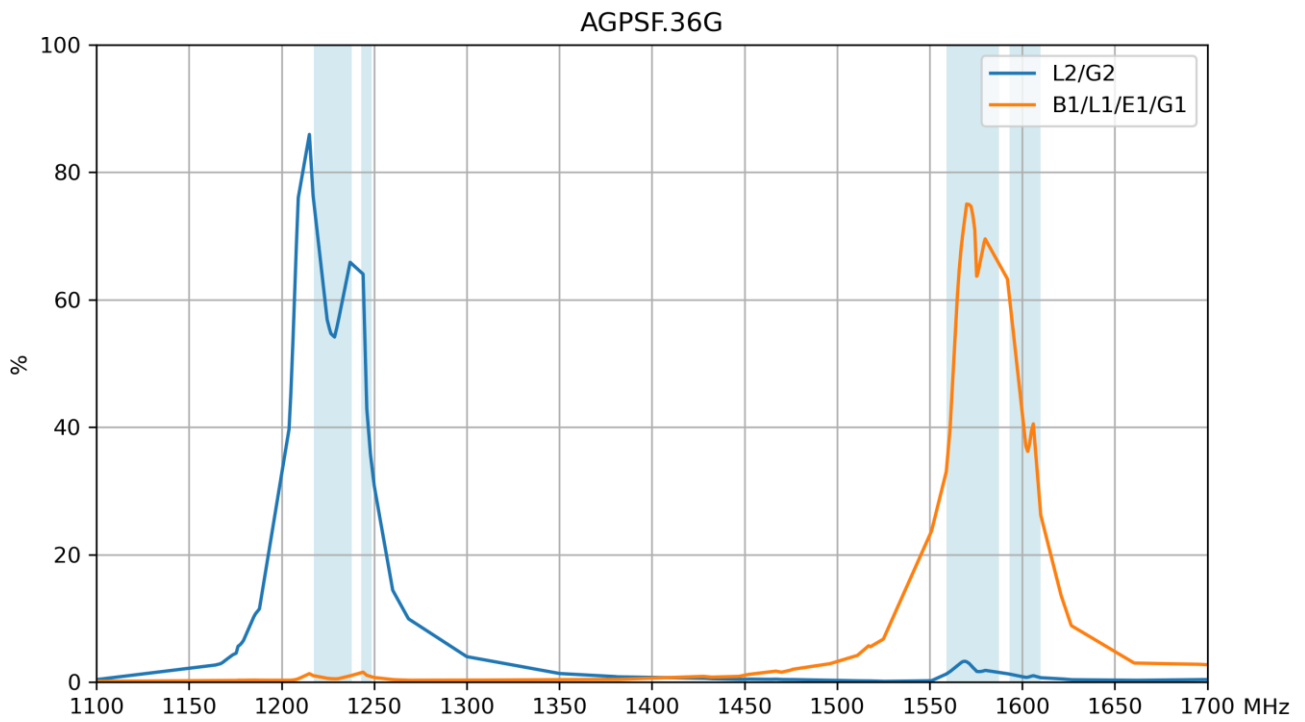

3.6 Average Gain

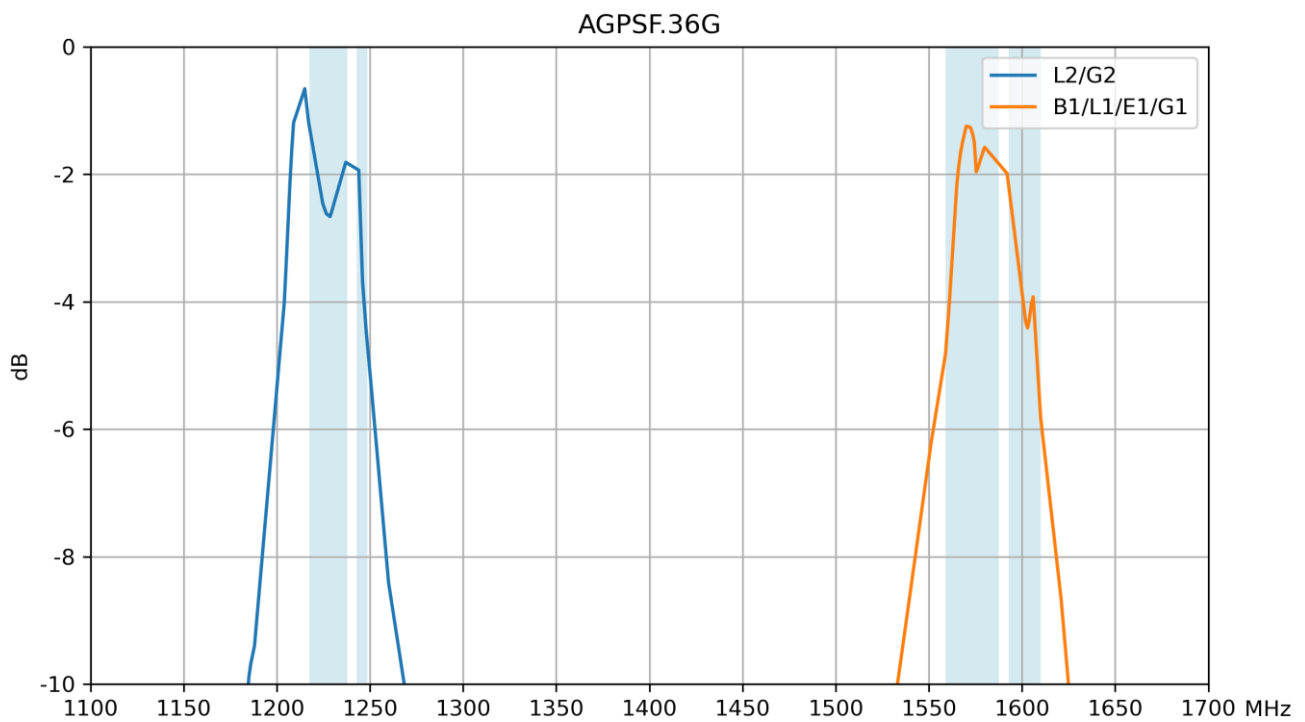

3.7 Peak Gain

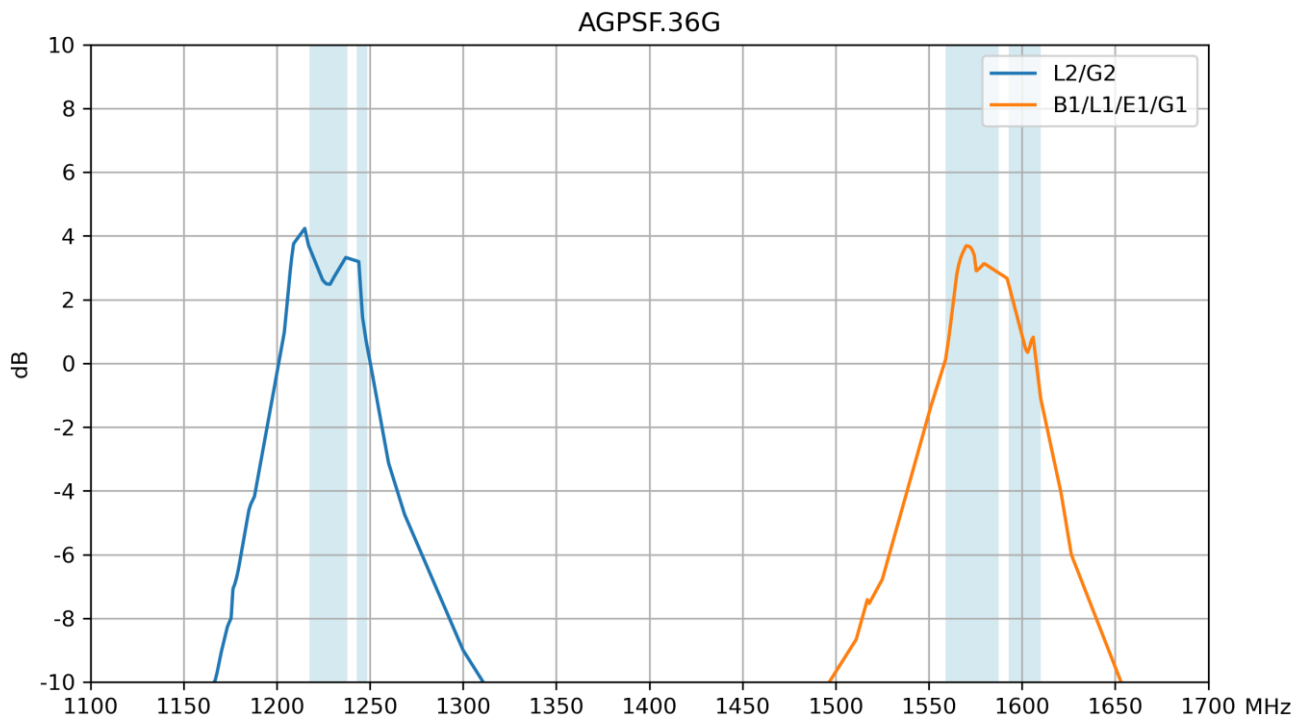

3.8 Axial Ratio

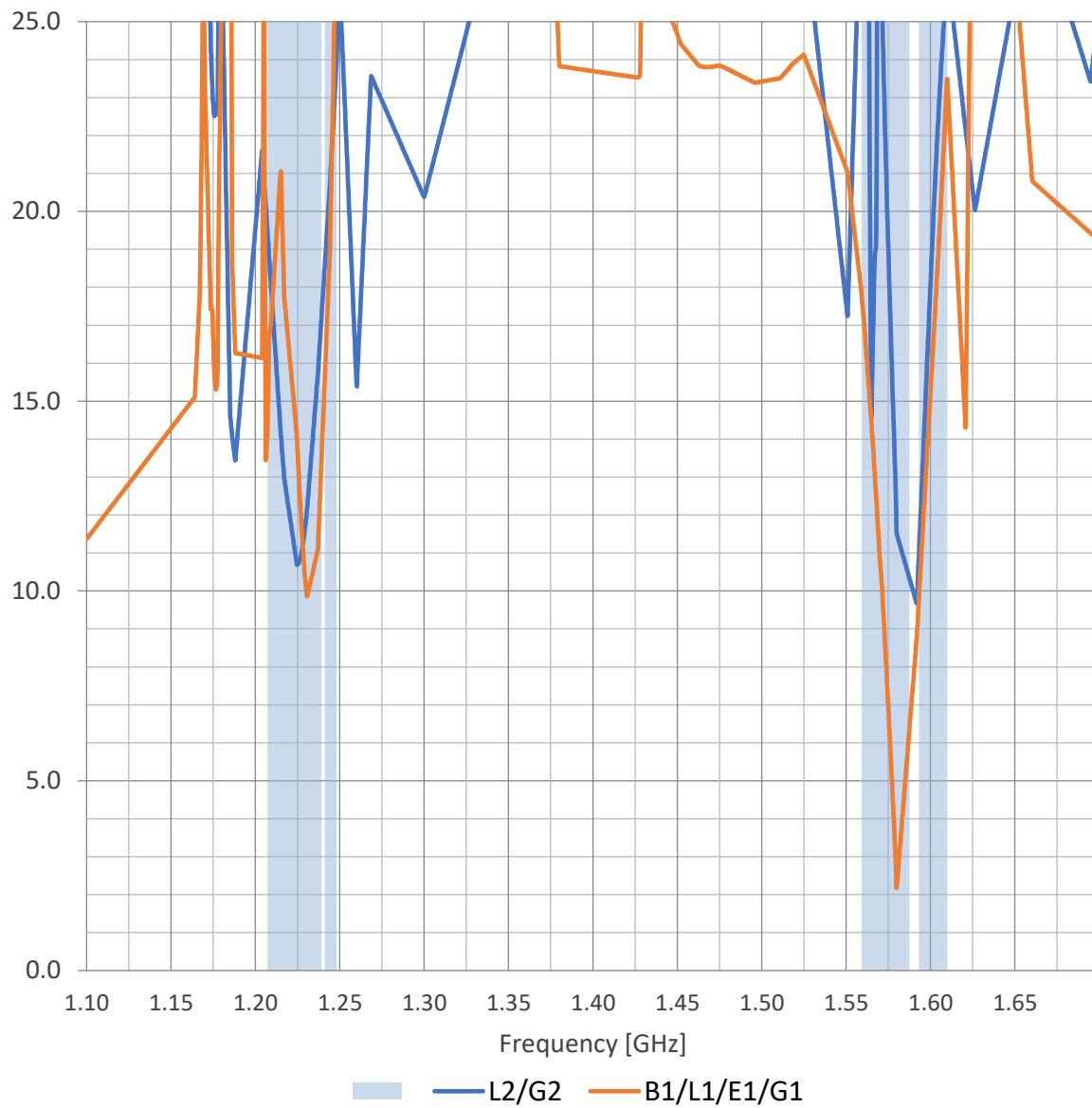

3.9 LNA Gain @3V (Active antenna)

GNSS L1

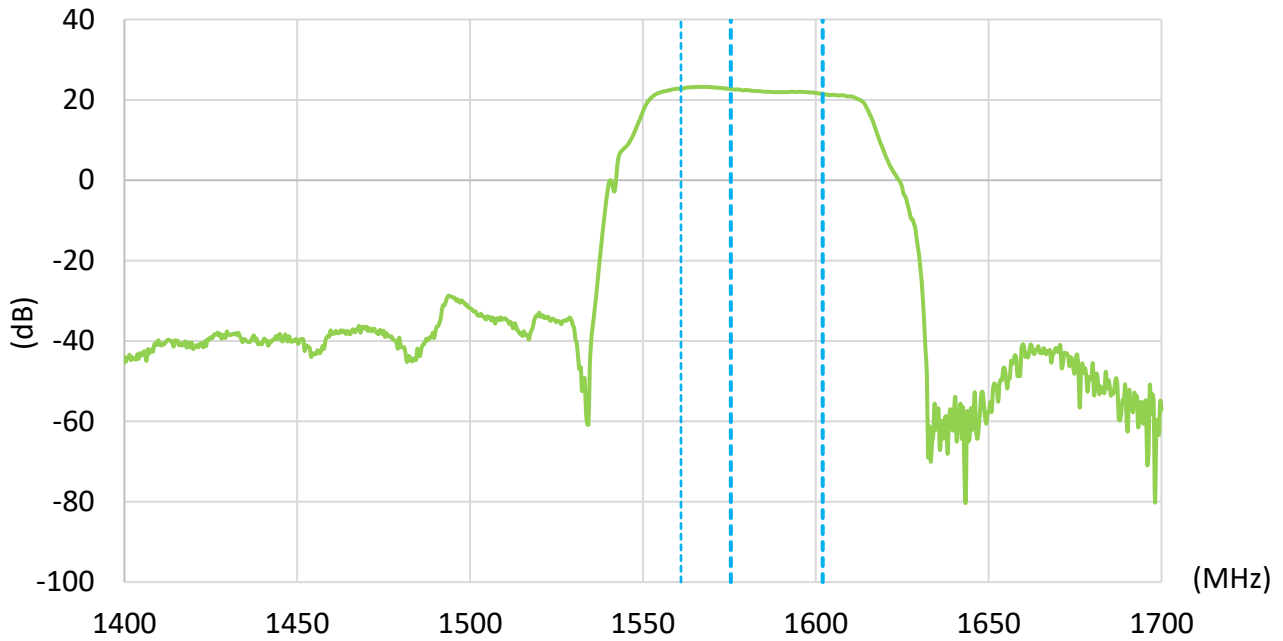

GNSS L2

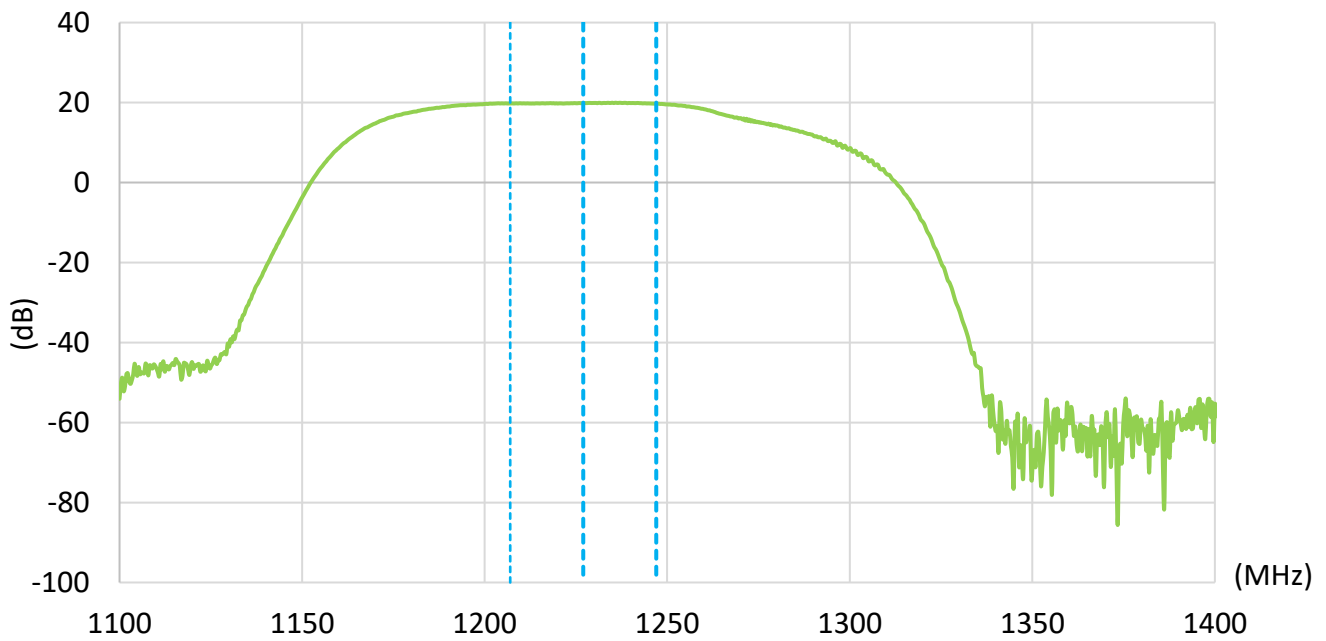

3.10 Out of Band Rejection

GNSS L1

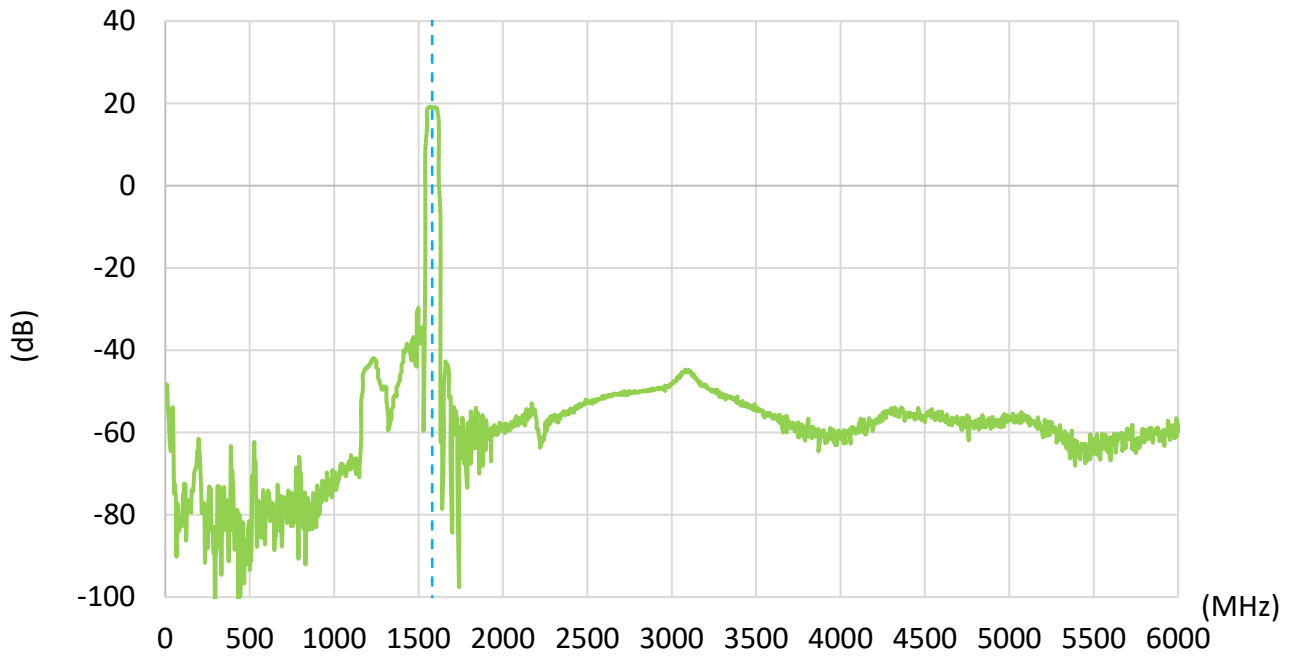

GNSS L2

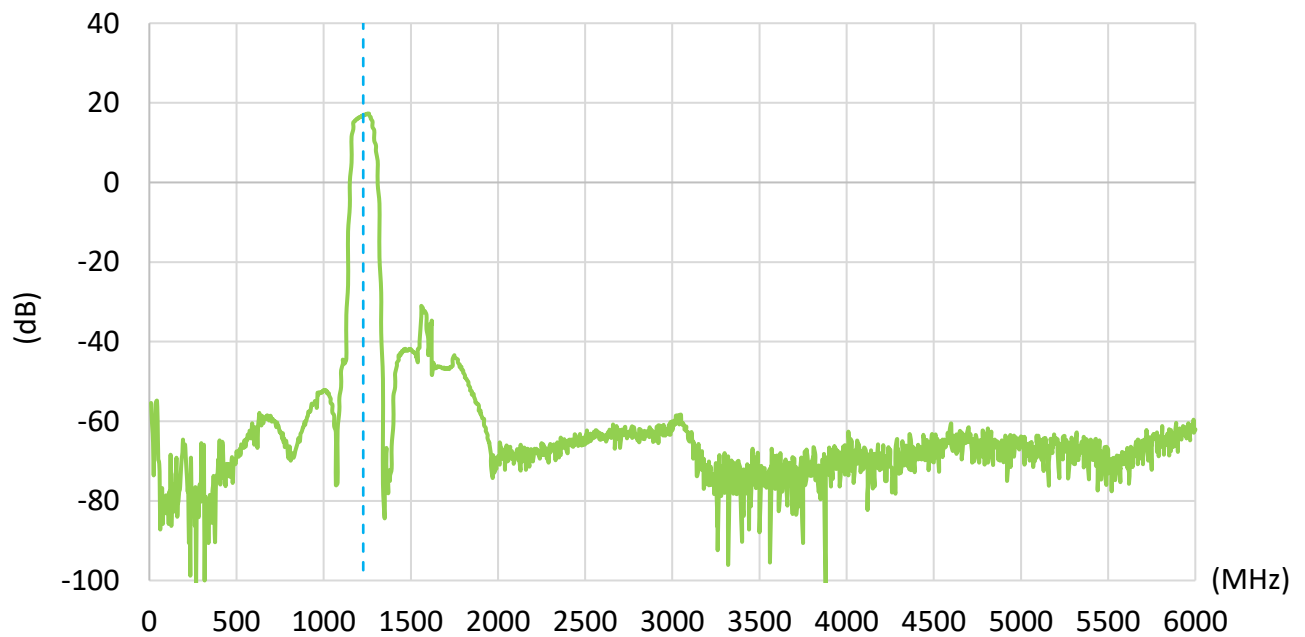

3.11 Noise Figure

GNSS L1

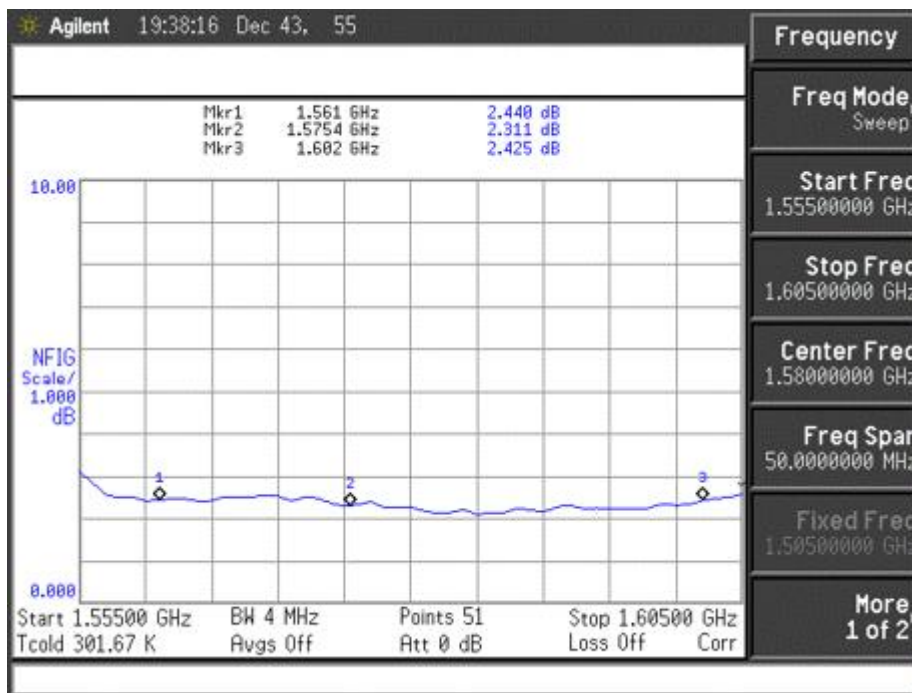

GNSS L2

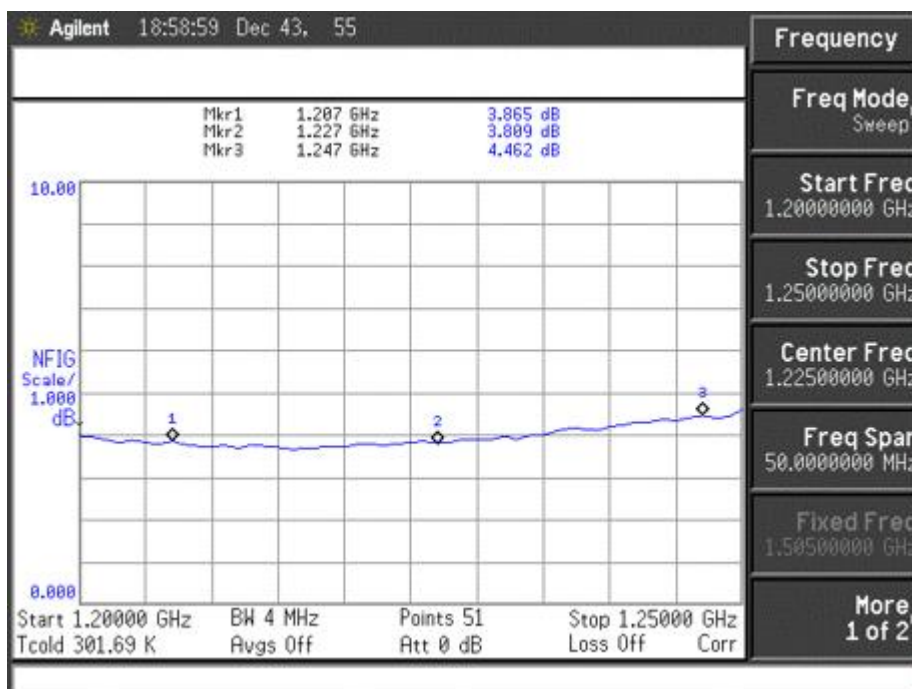

4. Radiation Patterns

4.1 Test Setup

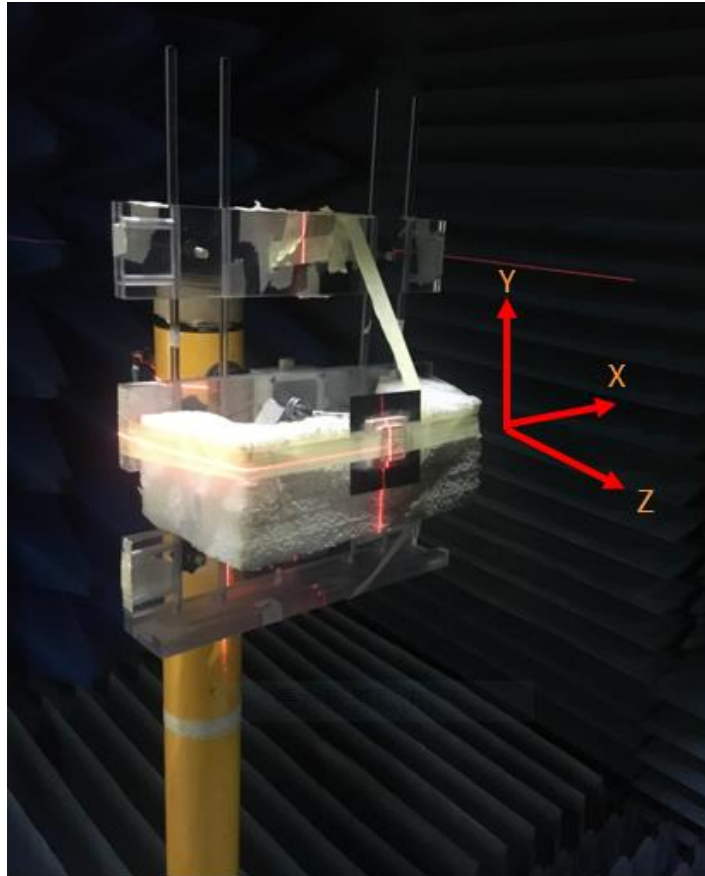

4.2 3D and 2D Radiation Patterns

1207MHz

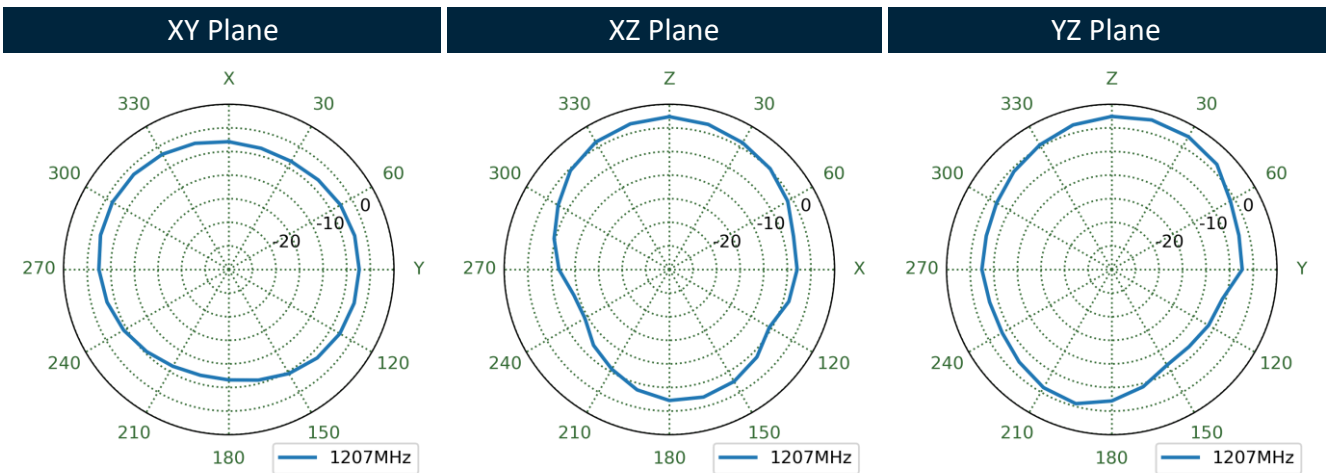
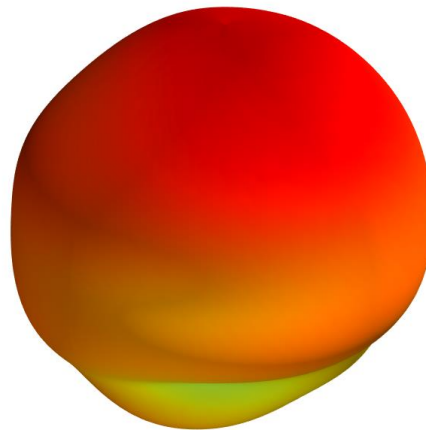

1227MHz

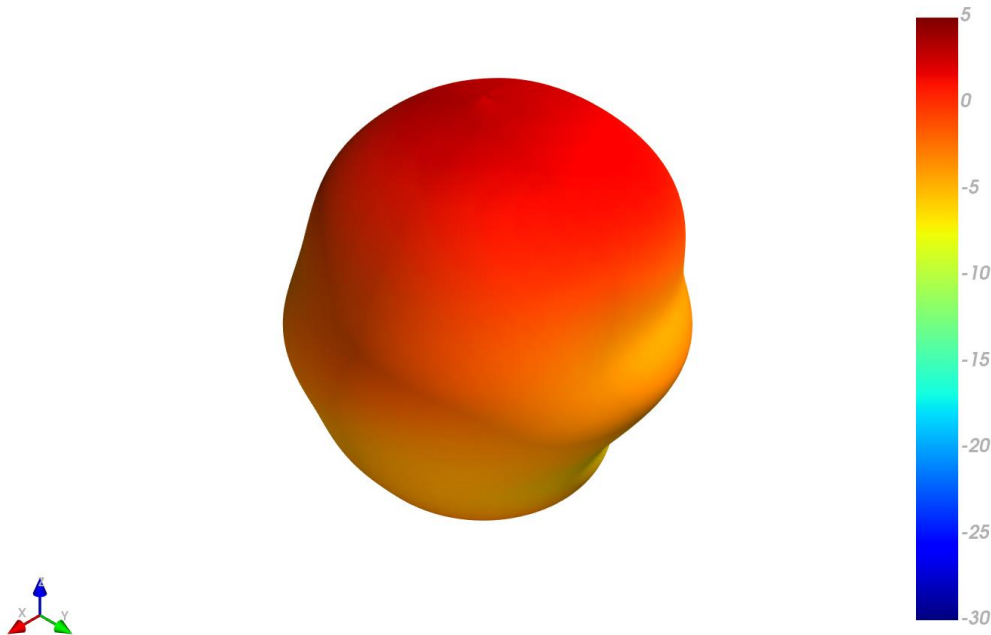

XY Plane

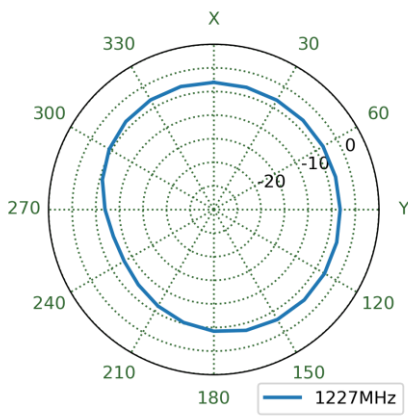

XZ Plane

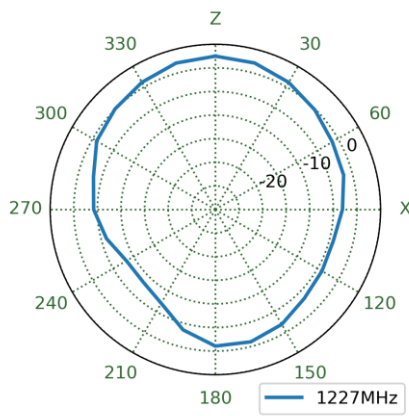

YZ Plane

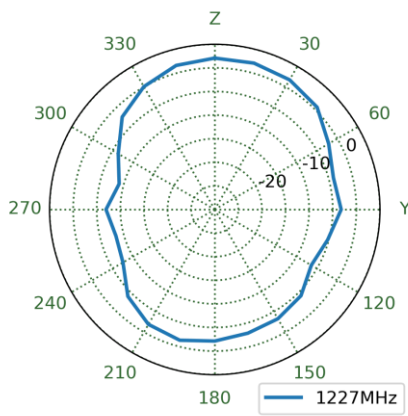

1248MHz

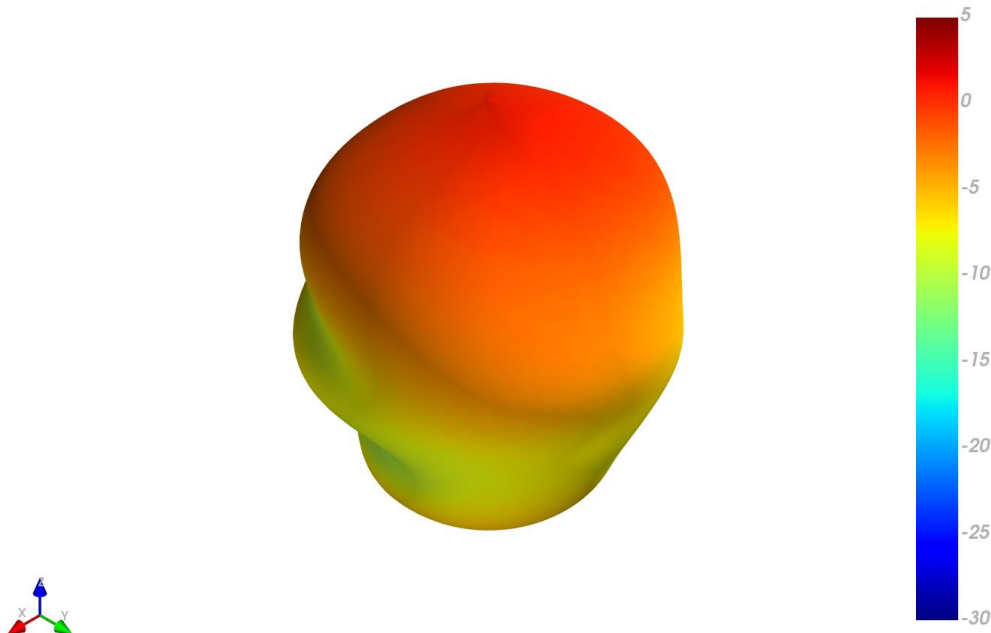

XY Plane

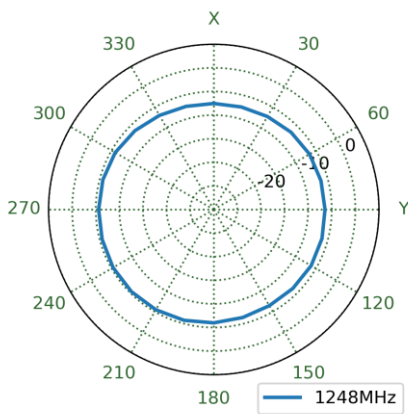

XZ Plane

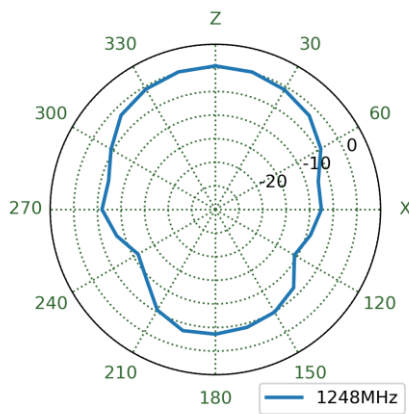

YZ Plane

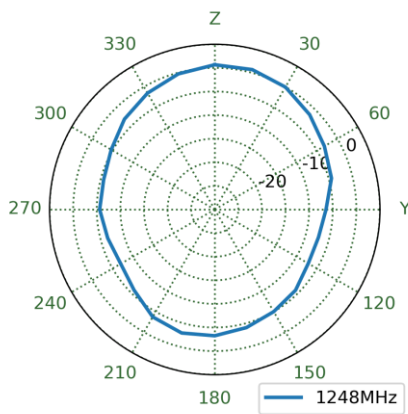

1561MHz

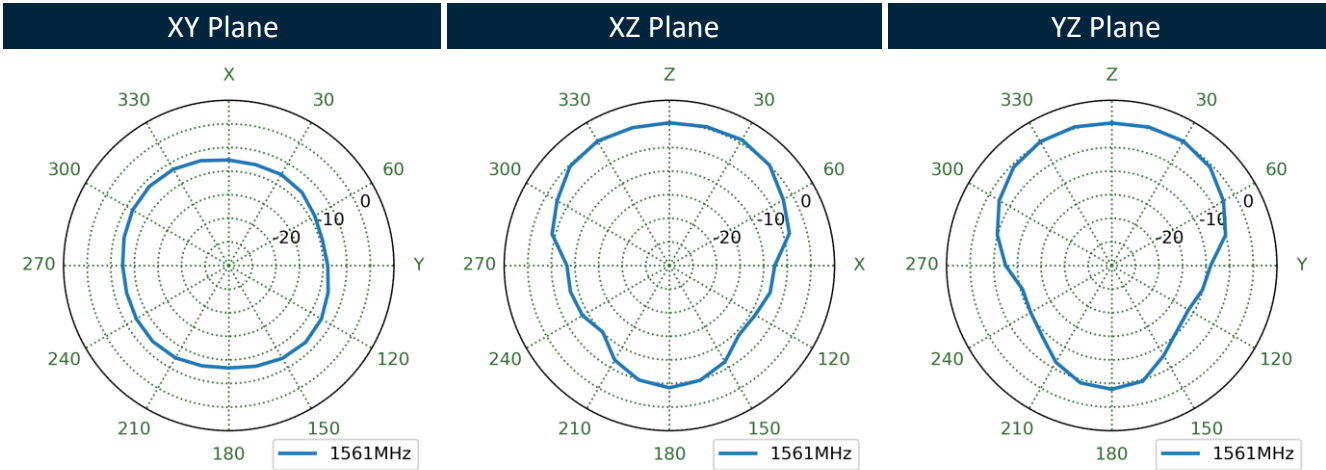
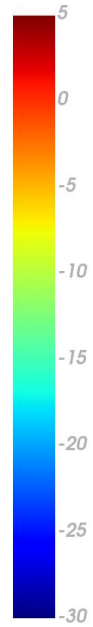
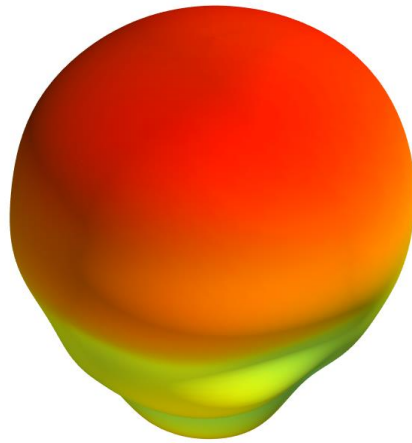

1575MHz

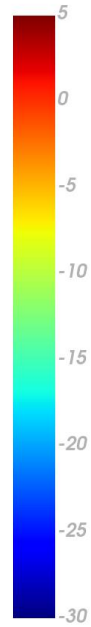
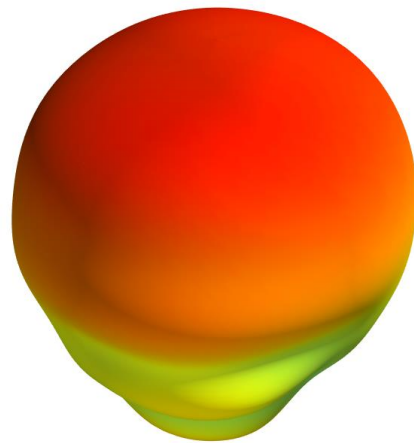

XY Plane

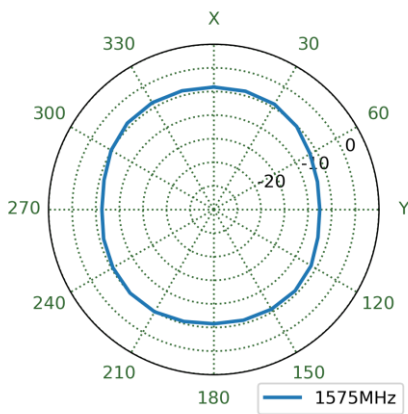

XZ Plane

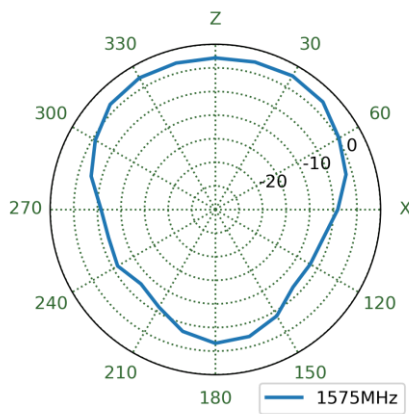

YZ Plane

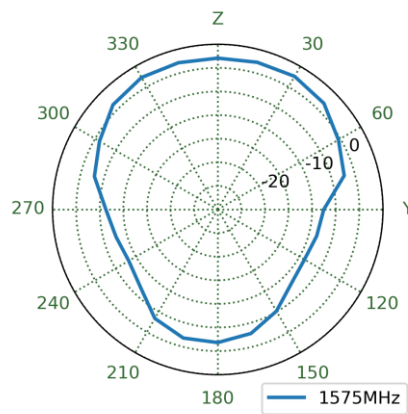

1602MHz

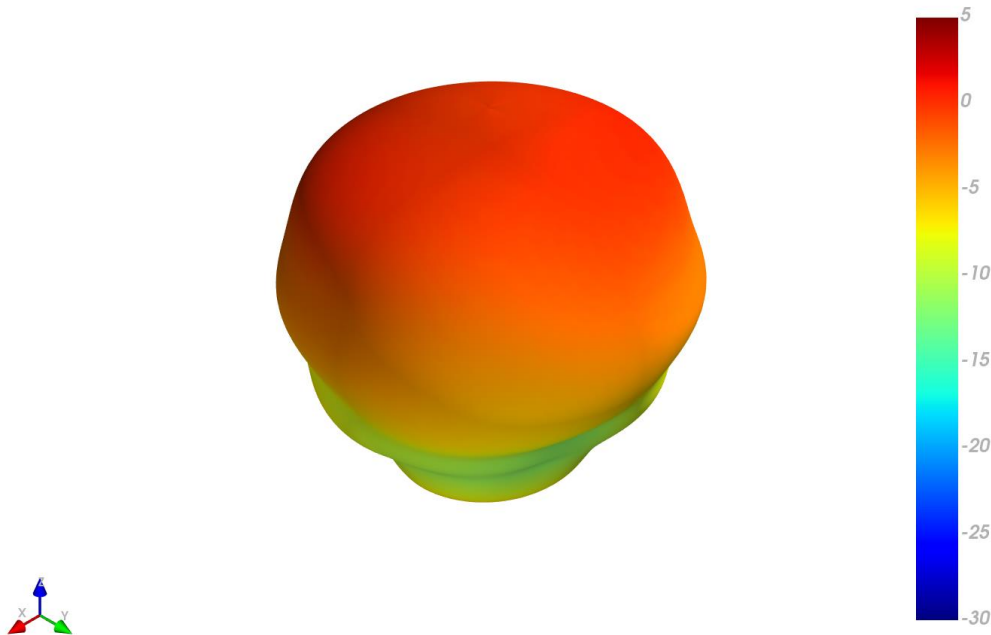

XY Plane

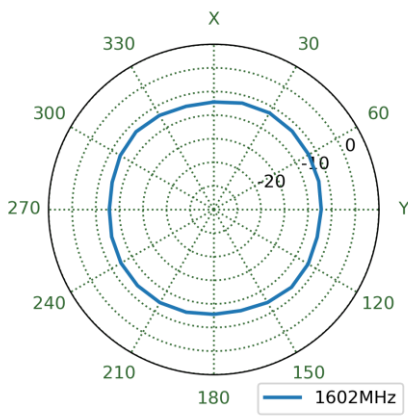

XZ Plane

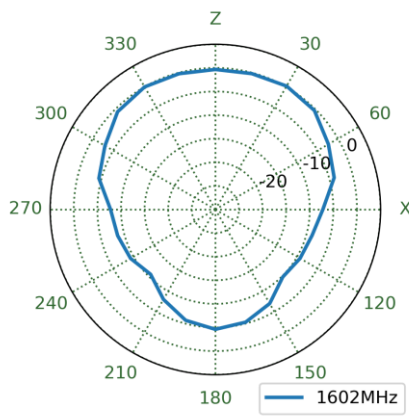

YZ Plane

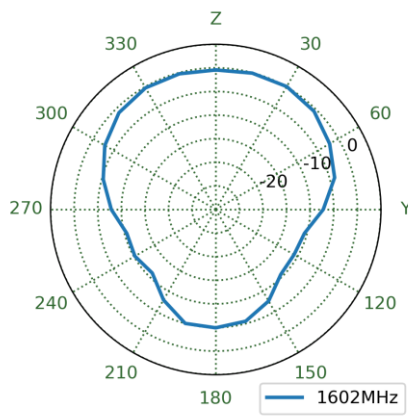

5. Field Test Results

5.1 Rooftop test

In this section Taoglas will present the field test result for AGPSF36C antenna. The test was performed when the antenna was mounted on a static rooftop test set up in an open sky environment for at least **6 hours**.

Taoglas will show the field test results using the following receiver:

1. U-blox ZED-F9P

Receiver features:

- Multi-band GNSS: 184-channel GPS L1C/A L2C, Galileo: E1B/C E5b, QZSS: L1C/A L2C
- Multi-band RTK with fast convergence times and reliable performance
- Nav. update rate RTK up to 20 Hz
- Position accuracy = RTK 0.01 m + 1 ppm CEP

Positioning Accuracy Table (2D Accuracy)				
Test Condition	Correction Service	CEP (50%)	DRMS (68%)	2DRMS (95-98.2%)
Free Space	RTK DISABLED	70.47 cm	84.35 cm	168.7 cm
	RTK ENABLED	8.28 cm	9.97 cm	19.82 cm

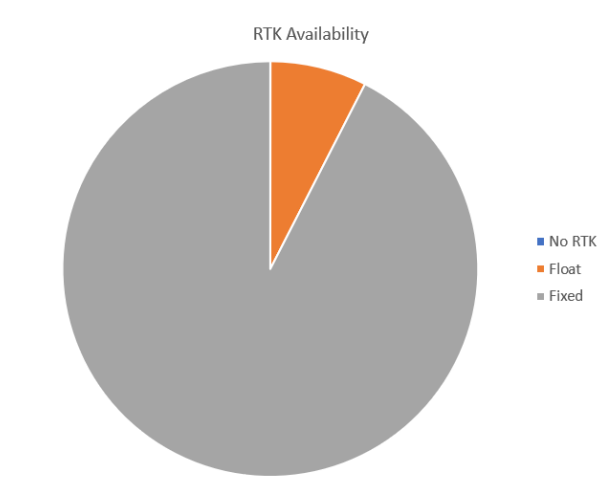
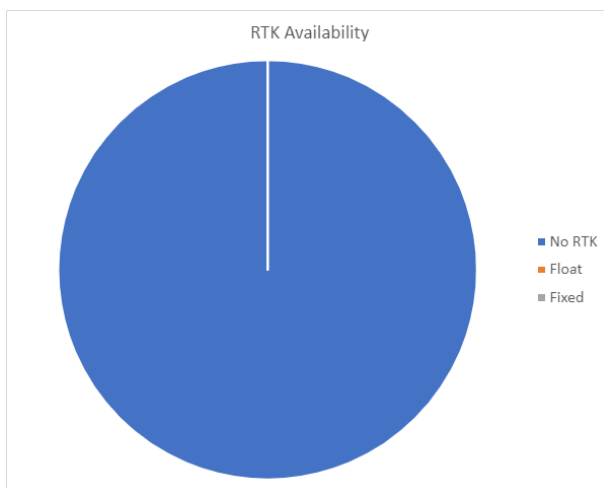

6. Mechanical Drawing (Units: mm)

ISO NO.: EDW-21-8-1053

STATE: Release

- NOTES:
1. Soldered Area.
 2. Soldermask Area.
 3. All material must be RoHS compliant.
 4. The connector orientation has a fixed position to the antenna as per drawing.

REV.	DESCRIPTION	ENG.	APPROVED	DATE
D01	Initial Design	Chi	Aaron	2021/09/01
D02	Add a cover in side view	Chi	Aaron	2021/09/06

IPEX MHFHT

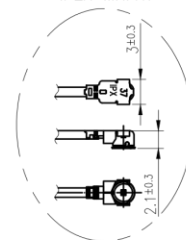

Front View

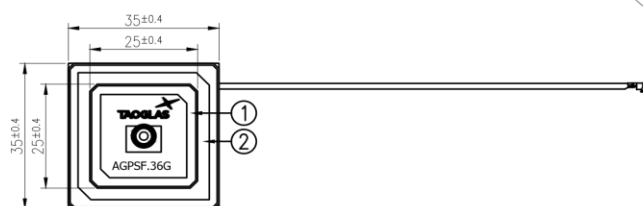

Side View

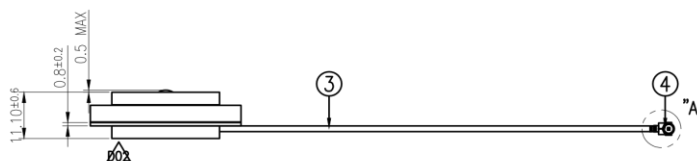

Back View

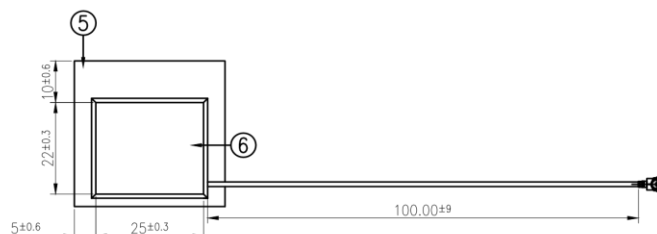

	Name	P/N	Material	Finish	QTY
1	Patch(25*25*3)	013ABBAL00a00D	Ceramic	Reddish Brown	1
2	Patch(35*35*4)	013ABBAL00a00D	Ceramic	Reddish Brown	1
3	1.37 Coaxial Cable	300515C010000A	FEP	Black	1
4	IPEX MHFHT(2021-112R-37)	204515C010000A	Brass	Au Plated	1
5	PCB	0211021216012D	Composite 0.8t	Black	1
6	Shielding Case	000518E030000A	STPE	Sn Plated	1

APPROVED BY: Aaron	TW Design Centre This drawing and its inherent design concepts are property of Taoglas. Not to be copied or given to third parties without the written consent of Taoglas.
CHECK BY: Amos	
DRAWN BY: Chi	
DATE: 2021/09/01	TITLE : Active GNSS L1L2 Low Profile Stacked Patch Antenna w/100mm 1.37 and IPEX MHFHT(U.FL comp)
UNLESS OTHERWISE SPECIFIED TOLERANCES ON: XX±0.5 X±0.3 .XX±0.2 .XX±0.1 .XXX±0.05	PART NO. : AGPSF.36G.07.0100C
THIRD ANGLE PROJECTION	UNIT: mm SCALE: 1:1.5 PAGES: 1/1 REV: D02

7. Packaging

30pc AGPSF.36C.07.0100A per Tray
 Tray Dimensions - 360*300*95mm
 Weight - 3.65Kg

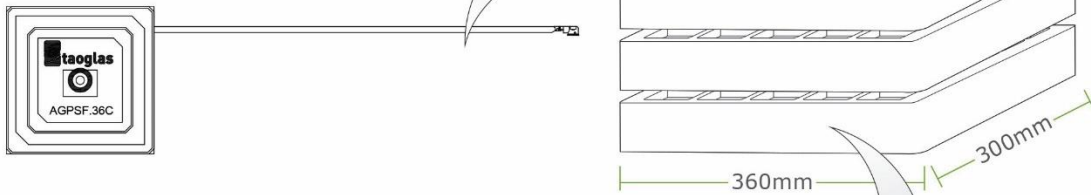

120pc AGPSF.36C.07.0100A per Carton
 Box Dimensions - 390*320*290mm
 Weight - 11.2Kg

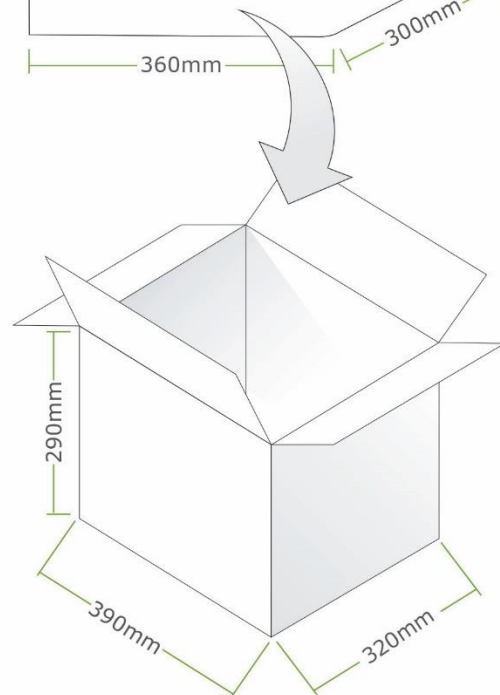

Pallet Dimensions:
 1200mm*1000mm*1360mm
 36 Cartons per Pallet
 9 Cartons per Layer, 4 Layers

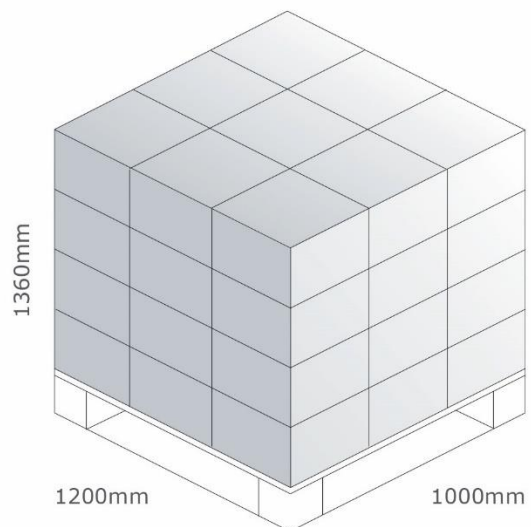

8. Application Note

Using Diplexers with an Active Dual-band Antenna

If your application requires separate L1 and L2 inputs—separate L1 and L2 receiver inputs, for example—then Taoglas diplexers may be used to interface between an active dual-band antenna and these separate inputs. Taoglas offers two GNSS diplexers, the DXP.01.A and DXP.02.A. The DXP.02.A add support for L5 signals (among others). These diplexers offer a unique off-the-shelf option for splitting the GNSS signals with minimal loss while improving out-of-band rejection. See the Taoglas website for further details on these components.



Figure 1 - Taoglas DXP.01.A

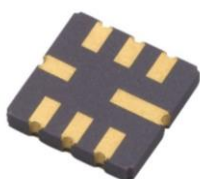

Figure 2 - Taoglas DXP.02.A

Since these components do not pass DC signals, particular attention needs to be paid when using an active antenna. Figure 3 provides a simplified schematic of what is required.

The key features are:

- DC blocks need to be included between the diplexer matching networks and the other subsystems. This helps protect the diplexer and prevent any unintended interactions between the matching network and DC voltages. A typical DC block for GNSS systems is a 22 pF COG ceramic capacitor.
- A separate Bias-T is required on the antenna side of the diplexer. Many receivers include these Bias-T networks internally, but these will be blocked by the diplexer (and DC blocks). A typical RF choke component for GNSS systems is a 39nH wire-wound inductor, though this should be reviewed during design time.



Figure 3 - Schematic

Finally, make sure to following the matching network and layout recommendations for the diplexer in their respective datasheets.

Changelog for the datasheet

SPE-21-8-126 - AGPSF.36G.07.0100C

Revision: C (Current Version)

Date:	2022-05-20
Notes:	Updated GNSS Bands & Constellations Graphics
Author:	Cesar Sousa

Previous Revisions

Revision: B

Date:	2022-05-20
Notes:	Updated GNSS Frequency Bands Covered Table.
Author:	Gary West

Revision: A (Original First Release)

Date:	2018-09-26
Notes:	Initial Release
Author:	Jack Conroy