

APPLICATION NOTE

VACUUM FLUORESCENT DISPLAY MODULE

スリムデザインディスプレイモジュール
SLIM DESIGN DISPLAY MODULE

AH145AA/AB/AC/
BA/BB/BC

概要 GENERAL DESCRIPTION

スリムデザインディスプレイモジュール

『AH145AA/AB/AC/BA/BB/BC』は、VFD を使用した 160×36 ドットを表示するモジュールです。

このモジュールは、VFD、ワンチップコントローラーと電源(DC-DC/AC コンバータ)から構成されておりますので、ホスト CPU と容易に接続することができます。

Slim Design Display Module

『AH145AA/AB/AC/BA/BB/BC』 with VFD display, produces 160×36 dots.

This module is composed of VFD, one chip controller, power supply (DC-DC/AC converter), is easy to connect to host CPU.



安全にお使いいただくために Important Safety Notice

安全に御使用頂く為に必ず本書をお読み下さい。
また、本書はお読みになった後も大切に保管して下さい。
Please read this note carefully before using the product.

警告 Warning

- 感電およびショートによる破損の恐れがある為、製品の金属部分に直接人体が触れないようにして頂くとともに、製品の基板上の部分が他の金属部品と接触しない様にして下さい。

There is fear of breakage by an electric shock and electrical short circuit.

Please prevent from touching a human body directly at the metallic portion of a product.

Please keep a product from contacting metal parts.

- モジュールの電源回路には、コンデンサが接続されております。
電源を切った後、直ちに回路をショートするとIC等を破損する事があります。
(放電には30秒程度の時間を要します) また、感電の恐れがありますので、製品の金属部分に直接人体が触れないようにして下さい。

After turning off the power, Electronic components may be damaged if a circuit is short-circuited.

Do not touch the electronic components of the module with any metal objects.

- モジュールには保護素子が搭載されており、何らかの不具合が発生した場合、保護素子が働き、事故を未然に防ぎます。

The module is equipped with a circuit protection Reset table Fuse.

- 外部の電源を入れたまま（又はモジュールの電源を入れたまま）電源ケーブルを抜き差しすることは絶対に避けて下さい。感電の原因になります。

The power supply should be switched off before connecting or disconnecting the power or interface cables.

- 分解、修理、改造は絶対にしないで下さい。感電や火災の原因になります。

Under no circumstances should the module be modified or repaired.

Any unauthorized modifications or repairs will invalidate the product warranty.

- 廃棄する場合には、特別管理産業廃棄物として処理して下さい。

The module should be abolished as the factory waste.

目 次

CONTENTS

| | |
|----------------|---|
| 1. 特長 FEATURES | 1 |
|----------------|---|

| | |
|--|---|
| 2. 一般仕様 GENERAL SPECIFICATIONS | |
| 2-1. 外形寸法・重量 DIMENSION, WEIGHT | 1 |
| 2-2. 製品種類 TYPE VARIATION | 2 |
| 2-3. 表示部仕様 SPECIFICATION OF THE DISPLAY | 2 |
| 2-4. 環境条件 ENVIRONMENT CONDITIONS | 2 |
| 2-5. 絶対最大定格 ABSOLUTE MAXIMUM ELECTRICAL | 3 |
| 2-6. 推奨動作条件 RECOMMEND OPERATING CONDITIONS | 3 |
| 2-7. 標準動作条件における電氣的、光学的特性 ELECTRICAL CHARACTERISTICS | 4 |

| | |
|--|----|
| 3. 基本機能 FUNCTION SUMMARY | |
| 3-1. RS232C インターフェース RS232C INTERFACE | 5 |
| 3-1-1. 受信の条件 DATA RECEPTION | 5 |
| 3-1-2. 異常時の処理 COMMUNICATION ERROR | 5 |
| 3-2. USB インターフェース USB INTERFACE | 5 |
| 3-2-1. USB-HID | 6 |
| 3-2-2. USB ディスクリプタ仕様 USB DESCRIPTOR SPECIFICATION | 7 |
| 3-3. Bluetooth(iAP)インターフェース BLUETOOTH(iAP) INTERFACE | 11 |
| 3-3-1. インターフェース INTERFACE | 11 |
| 3-3-2. 電波法認証 RADIO AUTHENTICATION METHOD | 11 |
| 3-3-3. Bluetooth 仕様 BLUETOOTH SPECIFICATION | 12 |
| 3-3-4. Bluetooth 動作状態説明 BLUETOOTH OPERATING STATE DESCRIPTION | 13 |
| 3-3-4-1. BT_STATUS_LED | 13 |
| 3-3-4-2. BT_RENEW_SW | 14 |
| 3-3-4-3. BT_CONNECT_SW | 14 |
| 3-3-5. iAP Accessory 設定 iAP ACCESSORY SETTINGS | 15 |
| 3-3-6. セキュリティ仕様 SECURITY | 15 |

| | |
|--|----|
| 3-3-7. ペアリング仕様 PAIRING SPECIFICATION..... | 15 |
| 4. コマンド COMMAND | |
| 4-1. コマンド詳細 FUNCTION OF COMMANDS..... | 16 |
| 5. コネクタ接続 CONECTER CONNECTION | |
| 5-1. RS232C TYPE (AH145AA/BA) | 35 |
| 5-2. USB TYPE (AH145AB/BB) | 36 |
| 5-3. BLUETOOTH (iAP) TYPE (AH145AC/BC) | 37 |
| FIGURE-1 外形図 Outer Dimensions..... | 38 |
| FIGURE-2 外形図 Outer Dimensions..... | 39 |
| FIGURE-3 ブロック図 RS232C Type (AH145AA/BA) Block Diagram | 40 |
| FIGURE-4 ブロック図 USB Type (AH145AB/BB) Block Diagram | 41 |
| FIGURE-5 ブロック図 BLUETOOTH(iAP) type (AH145AC/BC) Block Diagram | 42 |
| FIGURE-6 Font Table..... | 43 |
| 6. 保証 WARRANTY..... | 76 |
| 7. 規制物資等の該非判定及び、輸出する際の注意事項 CAUTIONS FOR DETERMINING AND EXPORTING REGULATED GOODS OR SERVICES..... | 76 |
| 8. 環 境 対 応 ENVIRONMENTALLY | 76 |
| 9. 使用上の注意事項 | 77 |

1. 特徴 FEATURES

- 1-1. 本製品は 160×36ドット、0.53×0.616ピッチの VFD で構成されている
ケース付モジュールです。

VFD module with case consists of a 160×36 number of pixels, 0.53×0.616 pitch dot matrix display.

- 1-2. 本製品のホスト間との通信プロトコルは RS232C、USB2.0 Full Speed Function、Bluetooth 3.0 に
準拠しております。

This module supports RS232C, USB2.0 Full Speed Function, Bluetooth 3.0 interface.

- 1-3. 本製品で表示画面を維持する場合は、定期的に関係表示画面を送信することを推奨します。

If you want to keep the display in this module, it is recommended that you regularly send the same display.

- 1-4. 電源は USB バスパワー(5V/500mA)で動作可能です。

Power supply is capable of operating on USB bus power (5V / 500mA).

- 1-5. 本製品には下表の文字フォントを搭載しております。

This module is mounted the character font of below table.

Table-1

| 1 バイト文字 1 byte character | | | | 2 バイト文字 2 byte character | |
|--------------------------|---------------|-----------|------------------------------|--------------------------|----------------------------|
| 番号 No. | フォント Font | 番号 No. | フォント Font | 番号 No. | フォント Font |
| 1 | USA | 13 | Latin America | 1 | Japanese font(shift JIS) |
| 2 | France | 14 | Korea | 2 | Simplified Chinese(GB2312) |
| 3 | Germany | 15 | PC437 (USA: Standard Europe) | 3 | Traditional Chinese(Big5) |
| 4 | Great Britain | 16 | Katakana | 4 | Hangul(KSC5601) |
| 5 | Denmark 1 | 17 | PC850 (Multilingual) | | |
| 6 | Sweden | 18 | PC860 (Portuguese) | | |
| 7 | Italy | 19 | PC863(Canadian-French) | | |
| 8 | Spain 1 | 20 | PC865 (Norwegian) | | |
| 9 | Japan | 21 | WPC1252 | | |
| 10 | Norway | 22 | PC866 [Cyrillic #2] | | |
| 11 | Denmark 2 | 23 | PC852 [Latin 2] | | |
| 12 | Spain 2 | 24 | PC858 | | |

2. 一般仕様 GENERAL SPECIFICATION

2-1. 外形寸法・重量 DIMENSIONS, WEIGHT (Refer to FIGURE-1)

Table-2

| 項目 Parameter | 仕様 Specification | 単位 Unit |
|-------------------------------|------------------------------------|---------|
| 外形寸法 Outer Dimensions (NOTE1) | (W)141±0.5 (H)79±1 (T)60±0.5 | mm |
| 重量 Weight | Approx.217 | g |

NOTE1) 外形寸法(T)と重量は、配線クランプと電源コードを含みません。

Outer Dimensions (T), Weight does not include the wiring clamp and power supply cable.

2-2. 製品種類 TYPE VARIATION

Table-3

| 製品番号 TYPE No. | ケース色 Case Color | インターフェース I/F | 付属ケーブル Supplied cable | ケーブル色 Cable Color |
|------------------|--------------------|-----------------|----------------------------|----------------------|
| AH145AA | White | RS232C | None | — |
| AH145BA | Black | RS232C | None | — |
| AH145AB | White | USB | USB type A to Mini B cable | White |
| AH145BB | Black | USB | USB type A to Mini B cable | Black |
| AH145AC | White | Bluetooth(iAP) | USB type A to Mini B cable | White |
| AH145BC | Black | Bluetooth(iAP) | USB type A to Mini B cable | Black |

2-3. 表示部仕様 SPECIFICATION OF THE DISPLAY

Table-4

| 項目 Parameter | 仕様 Specification | 単位 Unit |
|-------------------------------|------------------------------------|------------|
| 画面サイズ Display size | 98.46 (W)×18.98(H) | mm |
| 画素数 Number of Pixels | 160 (W)×36(H) | Dot |
| ドットサイズ Dot size | 0.43(W)×0.516(H) | mm |
| ドットピッチ Dot pitch | 0.53(W)×0.616(H) | mm |
| 発光色 Color illumination(NOTE2) | Green ($\lambda_p=505\text{nm}$) | — |

Note2) フィルタなしの発光色です。フィルタはグレースモークとなります。

Color illumination without filters. Filter is gray smoke.

2-4. 環境条件 ENVIRONMENT CONDITIONS

Table-5

| 項目 Parameter | 記号 Symbol | 最小 Min. | 最大 Max. | 単位 Unit |
|------------------------------|--------------|------------|------------|------------|
| 動作温度 Operation Temperature | Topr | 0 | +40 | ℃ |
| 保存温度 Storage Temperature | Tstg | -20 | +70 | ℃ |
| 動作湿度 Operation Humidity | Hopr | 20 | 85 | % |
| 保存湿度 Storage Humidity(Note3) | Hstg | 20 | 90 | % |
| 振動 Vibration (10~55Hz) | — | — | 4 | G |
| 衝撃 Shock | — | — | 40 | G |

Note3) 結露無きこと。 Avoid operations and or storage in moist environmental conditions.

2-5. 絶対最大定格 ABSOLUTE MAXIMUM ELECTRICAL RATINGS

Table-6

| 項目 Parameter | 記号 Symbol | 最小 Min. | 最大 Max. | 単位 Unit |
|--|-----------------|------------|------------|------------|
| 電源電圧 Supply Voltage | Vcc | -0.3 | +6.0 | Vdc |
| 入力信号電圧 (RS232C) Input Signal Voltage (RS232C) | V _{IS} | -15 | +15 | Vdc |
| 入力信号電圧 (USB) Input Signal Voltage (USB) | V _{IS} | -0.3 | +3.6 | Vdc |

2-6. 推奨動作条件 RECOMMEND OPERATING CONDITIONS

Table-7

| 項目 Parameter | 記号 Symbol | 最小 Min. | 標準 Typ. | 最大 Max. | 単位 Unit |
|---------------------|--------------|------------|------------|------------|------------|
| 電源電圧 Supply Voltage | Vcc | 4.75 | 5.0 | 5.25 | Vdc |

2-7. 標準動作条件における電氣的、光学的特性 ELECTRICAL CHARACTERISTICS

Table-8

| 項目 Parameter | 記号 Symbol | 条件 Condition | 最小 Min. | 標準 Typ. | 最大 Max. | 単位 Unit |
|--|-----------------|--|------------|------------|------------|-------------------|
| 消費電流 Supply Current (Note 4) | I _{cc} | V _{cc} =5.0V 文字表示 Character display | — | 380 | 500 | mA |
| 消費電力 Power Consumption | — | | — | 1.9 | 2.5 | W |
| 輝度 Luminance (Note 5) (Note 6) | L | | 350 | 700 | — | cd/m ² |
| 入力 H レベル電圧 (RS232C) H-level input Voltage | V _{IH} | V _{cc} =5.0V | 2.0 | — | 15 | V _{dc} |
| 入力 L レベル電圧 (RS232C) L-level input Voltage | V _{IL} | V _{cc} =5.0V | -15 | — | 0.8 | |
| 出力電圧 (RS232C) Output Voltage (RS232C) | V _O | All driver outputs loaded with 3kΩ to GND | ±5.0 | ±5.4 | — | |
| 入力 H レベル電圧 (USB) H-level input Voltage (USB) | V _{IH} | V _{cc} =5.0V | 2.0 | — | — | |
| 入力 L レベル電圧 (USB) L-level input Voltage (USB) | V _{IL} | V _{cc} =5.0V | — | — | 0.8 | |
| 差動入力感度 (USB) Differential Input Sensitivity (USB) | V _{DI} | V _{cc} =5.0V | 0.2 | — | — | |

Note4) RS232C 仕様の場合、電源投入時に最大電流の約 5 倍の突入電流が発生します。

USB/Bluetooth 仕様の場合、電源電圧部に 10μF 以下の容量があり、電源投入時に突入電流が発生します。

Case of the RS232C type, the surge current can be approx. 5 times the supply current (Max.) at power on.

Case of the USB/Bluetooth type, the capacity of 10 or less is in a power supply circuit of module. Inrush current occurs in power-on.

Note5) VFD の消費電流 500mA 未満にするために点灯率 の値によって輝度を低下し、消費電流を抑えます。

点灯率 40%以下で使用する場合、輝度 100%となります

点灯率 40%以上で使用する場合、点灯率に合わせて輝度を低下させます。全極点灯時に輝度 70%になるように調整しています。

VFD supply current reduces the brightness by lighting rate in order to be less than 500mA, it reduces the supply current. If you want to use in the lighting rate of 40% or less, it is 100% brightness. If you want to use in the lighting rate of 40% or more, the brightness is reduced by the lighting rate. It adjusted to 70% brightness at all ON display

Note6) 輝度レベル 100%の輝度値を示します。フィルタなしの値とします。フィルタの透過率は 23%となります。

The luminance level is set at 100% luminance value. It will be the value without the filter. Transmittance of the filter is 23%.

3. 基本機能 FUNCTION SUMMARY

3-1. RS232C インターフェース RS232C INTERFACE

Table-9

| 項目 Parameter | 仕様 Specification |
|-----------------|-----------------------------------|
| Signal level | RS-232C 準拠 RS-232C conformity |
| Baud Rate | 38,400 bps |
| Parity bit | NON |
| Data bit length | 8 bit(LSB first) |
| Format | Start(1bit)+Data(8bit)+Stop(1bit) |

3-1-1. 受信の条件 DATA RECEPTION

本モジュールには 256byte の受信バッファを持っています。

The module has 256 bytes buffers for data reception.

3-1-2. 異常時の処理 COMMUNICATION ERROR

- a) モジュールから送信されたデータが、伝送上の理由でホストに受信されなかった場合、そのデータについては、モジュールは伝送済みのデータとして扱います。

When transferred data cannot be received properly at host system by the reason of the transmission failure, the module makes it the transmitted data.

- b) ホストからコマンド受信時にオーバーラン、フレーミングエラーが発生した場合、そのコマンドを無視します。

In case of the command reception, when the overrun or the framing error occurs, the command is ignored.

- c) ホストからデータ受信時にオーバーラン、フレーミングエラーが発生した場合は、そのデータを無視します。

In case of the display data reception, when the overrun or the framing error occurs, the display data is ignored.

- d) ホストからコマンド受信時にパリティエラーが発生した場合は、そのコマンドを無視します。

In case of the command reception, when the parity error occurs, the command is ignored.

- e) ホストからデータ受信時にパリティエラーが発生した場合は、そのデータを無視します。

In case of the display data reception, when the parity error occurs, the display data is ignored.

- f) ホストからイリガルコマンドを受信した場合は、そのコマンドを無視します。

When an illegal command is received, the command is ignored.

3-2-2. USB ディスクリプタ仕様 USB DESCRIPTOR SPECIFICATION.

Standard Device Descriptor

Table-10

| Offset | Field | Description | Size[byte] | Value | Comment |
|--------|--------------------|--|------------|-------|-----------|
| 0 | bLength | Size of descriptor in bytes | 1 | 12H | |
| 1 | bDescriptorType | DEVICE Descriptor Type | 1 | 01H | |
| 2 | bcdUSB | USB Release Number in BCD | 2 | 0200H | Rev.2.0 |
| 4 | bDeviceClass | Class code | 1 | 00H | |
| 5 | bDeviceSubClass | Subclass code | 1 | 00H | |
| 6 | bDeviceProtocol | Protocol code | 1 | 00H | |
| 7 | bMaxPacketSize | Maximum packet size for endpoint zero | 1 | 40H | 64 bytes |
| 8 | idVendor | Vendor ID | 2 | 1008H | FUTABA |
| 10 | idProduct | Product ID | 2 | 1026H | GP1288A02 |
| 12 | bcdDevice | Device release number in BCD | 2 | 0400H | Rev.4.00 |
| 14 | iManufacturer | Index of string descriptor describing manufacturer | 1 | 01H | |
| 15 | iProduct | Index of string descriptor describing product | 1 | 02H | |
| 16 | iSerialNumber | Index of string descriptor describing the device's serial number | 1 | 00H | |
| 17 | bNumConfigurations | Number of possible configurations | 1 | 01H | |

Standard Configuration Descriptor

Table-11

| Offset | Field | Description | Size[byte] | Value | Comment |
|--------|---------------------|---|------------|-------|-------------|
| 0 | bLength | Size of this descriptor in bytes | 1 | 09H | |
| 1 | bDescriptorType | CONFIGURATION Descriptor Type | 1 | 02H | |
| 2, 3 | wTotalLength | Total length of data returned for this configuration | 2 | 0029H | 41 bytes |
| 4 | bNumInterfaces | Number of interfaces supported by this configuration | 1 | 01H | |
| 5 | bConfigurationValue | Value to use as an argument | 1 | 01H | |
| 6 | iConfiguration | Index of string descriptor describing this configuration | 1 | 00H | |
| 7 | bmAttributes | Configuration characteristics | 1 | 80H | Bus-powered |
| 8 | bMaxPower | Maximum power consumption | 1 | FAH | 500mA |

Interface Descriptor

Table-12

| Offset | Field | Description | Size[Byte] | Value | Comment |
|--------|--------------------|---|------------|-------|---------|
| 0 | bLength | Size of this descriptor in bytes | 1 | 09H | |
| 1 | bDescriptorType | INTERFACE Descriptor Type | 1 | 04H | |
| 2 | bInterfaceNumber | Number of this interface | 1 | 00H | |
| 3 | bAlternateSetting | Value used to select this alternate setting | 1 | 00H | |
| 4 | bNumEndpoints | Number of endpoints used by this interface | 1 | 02H | |
| 5 | bInterfaceClass | Class code | 1 | 03H | HID |
| 6 | bInterfaceSubClass | Subclass code | 1 | 00H | |
| 7 | bInterfaceProtocol | Protocol code | 1 | 00H | |
| 8 | iInterface | Index of string descriptor describing this interface | 1 | 00H | |

HID Descriptor

Table-13

| Offset | Field | Description | Size[Byte] | Value | Comment |
|--------|-----------------|--|------------|-------|----------------------|
| 0 | bLength | Size of HID descriptor | 1 | 09H | |
| 1 | bDescriptorType | HID descriptor type | 1 | 21H | HID Class descriptor |
| 2 | bcdHID | HID class specification | 2 | 0111H | HID Revision 1.11 |
| 4 | bCountry | Country code of the localized hardware | 1 | 00H | Not defined |
| 5 | bNumDescriptors | Number of class descriptors | 1 | 01H | 1 report descriptor |
| 6 | bReportType | Type of class descriptor | 1 | 22H | REPORT descriptor |
| 7 | wReportLength | Descriptor length | 2 | 002FH | 47 bytes |

Endpoint Descriptor

Table-14

| Offset | Description | Size[Byte] | Value | Comment |
|--------|--|------------|-------|--------------------|
| 0 | Size of this descriptor in bytes | 1 | 07H | |
| 1 | ENDPOINT Descriptor Type | 1 | 05H | |
| 2 | The address of the endpoint on the USB device described by this descriptor | 1 | 87H | EP7, IN |
| 3 | The endpoint's attributes | 1 | 03H | Interrupt Transfer |
| 4 | Maximum packet size this endpoint | 2 | 0040H | 64 bytes |
| 6 | Interval for polling endpoint for data transfers | 1 | 04H | 4[ms] |

Endpoint Descriptor

Table-15

| Offset | Description | Size[Byte] | Value | Comment |
|--------|--|------------|-------|--------------------|
| 0 | Size of this descriptor in bytes | 1 | 07H | |
| 1 | ENDPOINT Descriptor Type | 1 | 05H | |
| 2 | The address of the endpoint on the USB device described by this descriptor | 1 | 06H | EP6, OUT |
| 3 | The endpoint's attributes | 1 | 03H | Interrupt Transfer |
| 4 | Maximum packet size this endpoint | 2 | 0040H | 64 bytes |
| 6 | Interval for polling endpoint for data transfers | 1 | 04H | 4[ms] |

HID Report Descriptor

Table-16

| Part | Value (HEX) |
|----------------------------------|-------------|
| Usage Page(Vendor-defined), | 06 FF FF |
| Usage (VFD_CONTROL), | 09 00 |
| Collection (Application), | A1 01 |
| Usage (DATA_INPUT), | 09 02 |
| Logical Minimum (0), | 15 00 |
| Logical Maximum (255), | 26 FF 00 |
| Report Size (8), | 75 08 |
| Report Count (64), | 95 40 |
| Input (Data,Variable,Absolute), | 81 02 |
| Usage (DATA_OUTPUT), | 09 03 |
| Logical Minimum (0), | 15 00 |
| Logical Maximum (255), | 26 FF 00 |
| Report Size (8), | 75 08 |
| Report Count (64), | 95 40 |
| Output (Data,Variable,Absolute), | 91 02 |
| Usage (FEATURE), | 09 04 |
| Logical Minimum (0), | 15 00 |
| Logical Maximum (255), | 26 FF 00 |
| Report Size (8), | 75 08 |
| Report Count (64), | 95 40 |
| Feature(Data,Variable,Absolute), | B1 02 |
| End Collection | C0 |

String Descriptor

Table-17

| No | Part | Description | Value |
|------|-----------------|---------------------|-----------|
| No.0 | bLength | Length | 0x04 |
| | bDescriptorType | type=STRING | 0x03 |
| | bSting | LangID (English US) | 0x0409 |
| No.1 | bLength | Length | 0x0E |
| | bDescriptorType | Type=STRING | 0x03 |
| | bSting | Manufacturer | FUTABA |
| No.2 | bLength | Length | 0x14 |
| | bDescriptorType | Type=STRING | 0x03 |
| | bSting | Product | GP1288A02 |

3-3. Bluetooth(iAP)インターフェース BLUETOOTH(IAP) INTERFACE

3-3-1. インターフェース INTERFACE

本製品のホスト間との通信プロトコルは Bluetooth 3.0 に準拠しております。

本製品の Bluetooth(iAP)対応機種は iPad Air, iPad Air2 となります。

本製品は、全ての Bluetooth 対応機器との接続を保証するものではありません。

This module supports Bluetooth 3.0 interface.

Bluetooth (iAP) support model of this module becomes iPad Air, iPad Air2.

Not guaranteed to connect to all Bluetooth devices.

3-3-2. 電波法認証 RADIO AUTHENTICATION METHOD

本製品は日本(工事設計認証)、米国(FCC)、カナダ(IC)の各種認証を取得済み、および欧州(CE)

規格の適合確認済みです。以下に各国の電波法で仕様書への必要事項について記載します。

This product is Japan (certificate of construction type), US (FCC), Canada (IC) of the various authentication already acquired, and Europe (CE) standards of suitability confirmed. The following summarizes the described items required in the specifications in the Radio Law of each country.

Table-18

| 項目 Parameter | 必要事項 Matters |
|---|---|
| 日本(工事設計認証) Japan (certificate of construction type) | 本製品には電波法に基づく工事設計認証を受けた特定無線設備を用いています。 |
| 米国(FCC) US (FCC) | <p>This device complies with part 15 of the FCC Rules. Operation is subject to the following two conditions: (1) This device may not cause harmful interference, and (2) this device must accept any interference received, including interference that may cause undesired operation.</p> <p>FCC CAUTION Change or modifications not expressly approved by the party responsible for compliance could void the user's authority to operate the equipment.</p> <p>This transmitter must not be co-located or operated in conjunction with any other antenna or transmitter.</p> <p>Caution Exposure to radio frequency radiation To comply with FCC RF exposure compliance requirements, a separation distance of at least 20 cm must be maintained between the antenna of this device and all persons. This device must not be co-located or operating in conjunction with any other antenna or transmitter.</p> |

| | |
|---------------------------------|--|
| <p>カナダ (IC) Canada (IC)</p> | <p>This device complies with Industry Canada licence-exempt RSS standard(s). Operation is subject to the following two conditions: (1) this device may not cause interference, and (2) this device must accept any interference, including interference that may cause undesired operation of the device.</p> <p>Le présent appareil est conforme aux CNR d'Industrie Canada applicables aux appareils radio exempts de licence. L'exploitation est autorisée aux deux conditions suivantes : (1) l'appareil ne doit pas produire de brouillage, et (2) l'utilisateur de l'appareil doit accepter tout brouillage radioélectrique subi, même si le brouillage est susceptible d'en compromettre le fonctionnement.</p> <p>To reduce potential radio interference to other users, the antenna type and its gain should be so chosen that the equivalent isotropically radiated power (EIRP) is not more than that required for successful communication.</p> <p>Pour réduire le potentiel d'interférence radioélectrique pour d'autres utilisateurs, le type d'antenne et son gain doivent être choisis pour que la puissance isotrope rayonnée équivalente (PIRE) soit limitée à celle juste requise pour obtenir une bonne communication.</p> <p>To comply with IC RF exposure compliance requirements, this device must not be co-located or operating in conjunction with any other antenna or transmitter.</p> <p>Pour se conformer aux exigences de conformité de la IC, cet appareil ne doit pas être co-localisées ou opérant en conjonction avec une autre antenne ou transmetteur</p> |
| <p>欧州 (CE) Europe (CE)</p> | <p>None</p> |

3-3-3. Bluetooth 仕様 BLUETOOTH SPECIFICATION

Table-19

| 項目 Parameter | 仕様 Specification |
|--|--|
| 準拠仕様 Conformity specification | Bluetooth 3.0 |
| パワークラス Power Class | CLASS 2 |
| 対応 Profile (AH145AC/BC) Supported Profile(AH145AC/BC) | iAP(iPod Accessory Protocol) <ul style="list-style-type: none"> • iAP1 • iAP2 |

3-3-4. Bluetooth 動作状態説明 BLUETOOTH OPERATING STATE DESCRIPTION

3-3-4-1. BT_STATUS_LED

LED の点滅で Bluetooth の動作状態を通知します。

Notify the Bluetooth operating state in flashing LED.

BT_STATUS_LED
LED Color : Orange

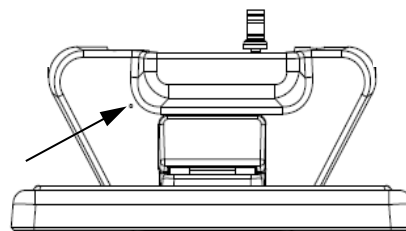

■ Inquiry (通信相手探索)

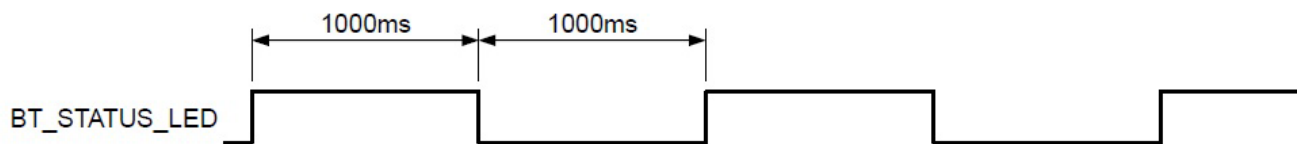

■ Discoverable (通信相手発見待ち)



■ Connectable (通信接続待ち)



■ Pairing (ペアリング)

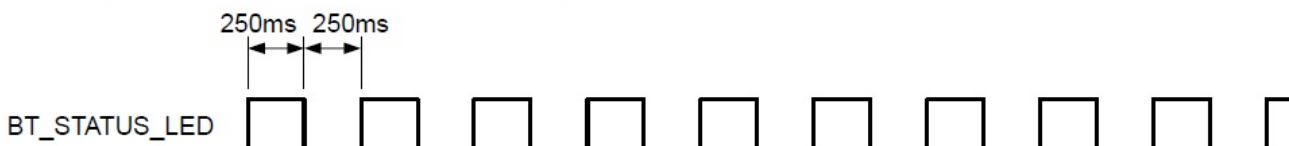

■ Connecting (通信接続判定)

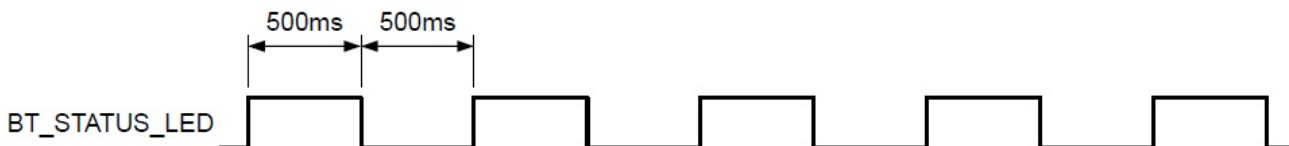

■ iAP(iAP1/ iAP2) Connected (iAP 接続)



■ **Disconnecting** (通信切断中)

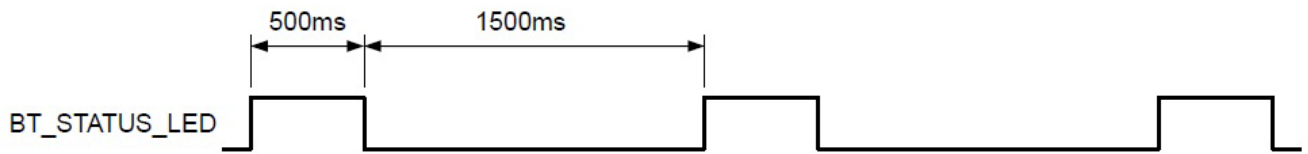

3-3-4-2. BT_RENEW_SW

RENEW スイッチを押す時間によって下記のように動作します。

スイッチ短押し: Bluetooth 接続/切断

スイッチ長押し: ペ어링情報データベースをクリア

It will work as follows by the time press RENEW switch.

Switch short press: Bluetooth connection / disconnection.

Switch long press: Clear the pairing information database.

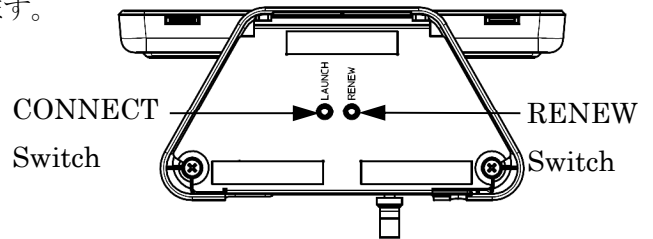

3-3-4-3. BT_CONNECT_SW

CONNECT スイッチを押すことで、本製品から最後に接続した iOS 機器へ再接続を開始する信号を送信します。

Pressing CONNECT switch, send a signal to start reconnecting from this module to the last connected iOS device.

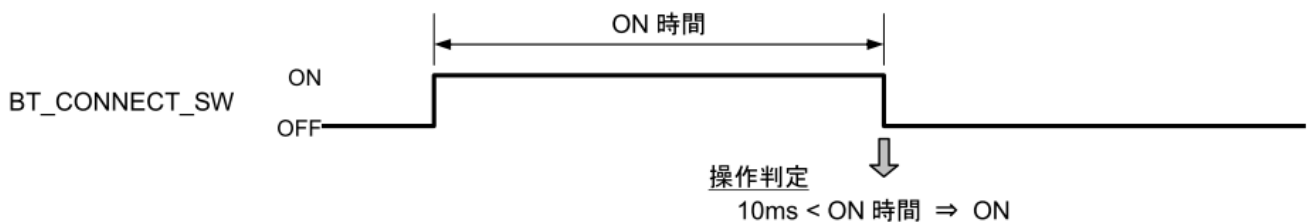

3-3-5. iAP Accessory 設定 iAP ACCESSORY SETTINGS

Table-20

| 項目 Parameter | 仕様 Specification |
|---------------------------------------|----------------------------------|
| Profile Settings | 3 (iAP Enable) |
| Data Transmission Mode | 0 (iAP Data Through Mode) |
| Autonomous Launch | 0 (Disable Autonomous launch) |
| Accessory Incoming Max Payload Size | 400 |
| Accessory name | “Slim design display” |
| Manufacturer | “Futaba Corporation” |
| Model Number | “AH145AC” or “AH145BC” |
| Serial Number | “0000001”~ |
| Firmware version | 1. 0. 0 |
| Hardware version | 1. 0. 0 |
| Protocol string | “com.futaba.protocol” |
| Protocol MetadataType | 2 |
| Bundle seed ID number | “ASLQTPDR6Q” |
| Application Bundle ID String | “com.futaba.app” |
| Accessory RF Certifications | 0 |
| Maximum Number of Outstanding Packets | 5 |
| Cumulative Acknowledgements | 3, 0x03E8 |

3-3-6. セキュリティ仕様 SECURITY SPECIFICATION

Table-21

| 項目 Parameter | 仕様 Specification |
|----------------------------|------------------|
| 固定 PIN Code Fixed PIN Code | 0000 |
| セキュリティ設定 Security setting | 1 |

3-3-7. ペアリング仕様 PAIRING SPECIFICATION

ペアリング情報データベースは最大 8 台までのペアリング情報が登録可能です。

ペアリング情報には接続履歴が含まれます。接続履歴は、最後に接続した相手が最新となるよう、接続をする度に並び替えを行います。8 台を超えてペアリングを行うと、最も古く接続した相手のペアリング情報を削除し、新しく接続した相手のペアリング情報を追加します。

Max 8 pairing information can be registered in the pairing information database. Pairing information is included in connection history. The connection history is rearranged each time the connection is made so that the last connected party becomes the latest. When more than 8 pairing is performed, the pairing information of the oldest connected party is deleted, and the pairing information of the newly connected opponent is added.

4. コマンド COMMAND

本モジュールは、以下のコマンドを有します。

The followings are all commands of this module.

| No. | Command | Byte | 1st | 2nd | 3rd | 4th | 5th | 6th | 7th | 8th | 9th | 10th | 11th | 12th ~ |
|-----|-------------------------------|----------|-----|-----|---------------|-----|-----------|-----------|-----------|-------------------|-----|-----------|------|---------------|
| 1 | BACKSPACE | 1 | 08h | | | | | | | | | | | |
| 2 | HORIZONTAL TAB | 1 | 09h | | | | | | | | | | | |
| 3 | LINE FEED | 1 | 0Ah | | | | | | | | | | | |
| 4 | CARRIAGE RETURN | 1 | 0Dh | | | | | | | | | | | |
| 5 | GRAPHIC MODE | 802 | 1Bh | 20h | <i>Pd ...</i> | | | | | | | | | |
| 6 | SET COUNTRY CODE | 3 | 1Bh | 52h | <i>n</i> | | | | | | | | | |
| 7 | DELETE TO END OF LINE | 4 | 1Bh | 5Bh | 30h | 4Bh | | | | | | | | |
| 8 | MODULE INFORMATION RESPONSE | 4 | 1Bh | 5Bh | 30h | 63h | | | | | | | | |
| 9 | CLEAR SCREEN | 4 | 1Bh | 5Bh | 32h | 4Ah | | | | | | | | |
| 10 | HOME POSITION | 4 | 1Bh | 5Bh | 48h | 27h | | | | | | | | |
| 11 | TURN ON/OFF DISPLAY | 4 | 1Bh | 5Bh | <i>n</i> | 50h | | | | | | | | |
| 12 | SPECIFIED POSITION | 6 | 1Bh | 5Bh | <i>Py</i> | 3Bh | <i>Px</i> | 48h | | | | | | |
| 13 | CURSOR MODE | 6 | 1Bh | 5Ch | 3Fh | 4Ch | 43h | <i>Ps</i> | | | | | | |
| 14 | LCD CONTRAST & VFD BRIGHTNESS | 7 | 1Bh | 5Ch | 3Fh | 4Ch | 44h | <i>Pc</i> | <i>Pb</i> | | | | | |
| 15 | SINGLE LINE SCROLL SETTING | 8-264 | 1Bh | 5Ch | 3Fh | 4Ch | 48h | <i>Pl</i> | <i>Pt</i> | <i>Pd ... 00h</i> | | | | |
| 16 | USER DEFINED CHARACTERS | 27 or 44 | 1Bh | 5Ch | 3Fh | 4Ch | 57h | <i>Pf</i> | 3Bh | <i>Pn</i> | 3Bh | <i>Pc</i> | 3Bh | <i>Pd ...</i> |

Table - 22

4-1. コマンド詳細 FUNCTION OF COMMANDS

本製品の制御コマンドは以下の通りです。Following is the details of each command.

4-1-1. BACKSPACE

Code: 08h

MSB

LSB

Table - 23

| Code | Byte | Bit7 | Bit6 | Bit5 | Bit4 | Bit3 | Bit2 | Bit1 | Bit0 | Note |
|------|------|------|------|------|------|------|------|------|------|------|
| 08h | 1st | 0 | 0 | 0 | 0 | 1 | 0 | 0 | 0 | |

Function: Moves the cursor one character position to the left.

When the cursor is at the left end of the lower line, it is moved to the right end of the upper line. When it is at the left end of the upper line, it is moved to the right end of the lower line.

機能: カーソルを1文字左に移動します。

カーソルが下段の左端にある場合、上段の右端に移動します。上段の左端にある場合は、下段の右端に移動します。

[Example]

//Before command is sent

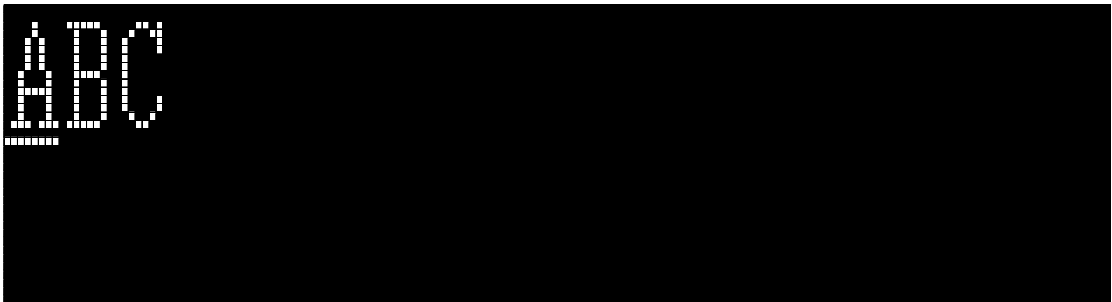

//Send command

Send(08h);

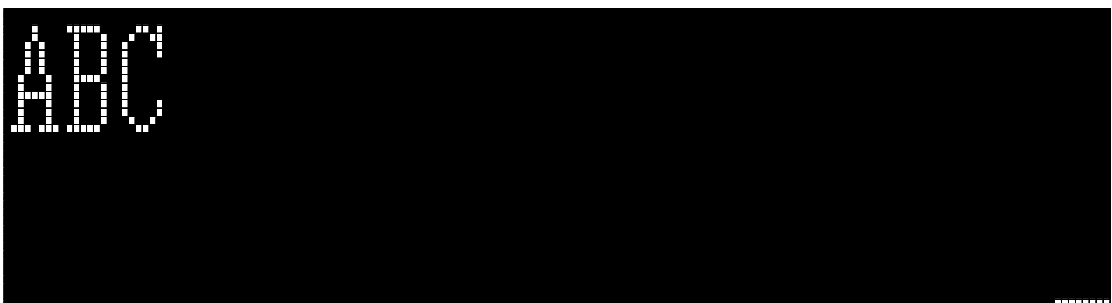

4-1-2. HORIZONTAL TAB

Code: 09h

MSB

LSB

Table - 24

| Code | Byte | Bit7 | Bit6 | Bit5 | Bit4 | Bit3 | Bit2 | Bit1 | Bit0 | Note |
|------|------|------|------|------|------|------|------|------|------|------|
| 09h | 1st | 0 | 0 | 0 | 0 | 1 | 0 | 0 | 1 | |

Function: Moves the cursor one character position to the right.

When the cursor is at the right end of the upper line, it is moved to the left end of the lower line. When it is at the right end of the lower line, it is moved to the left end of the upper line.

機能: 右にカーソルを1文字位置を移動します。

カーソルが下段の右端にある場合、上段の左端に移動します。上段の右端にある場合は、下段の左端に移動します。

[Example]

//Before command is sent

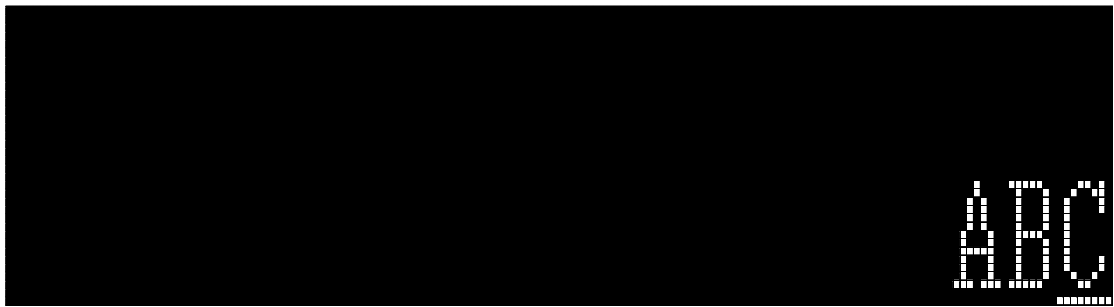

//Send command

Send(09h);

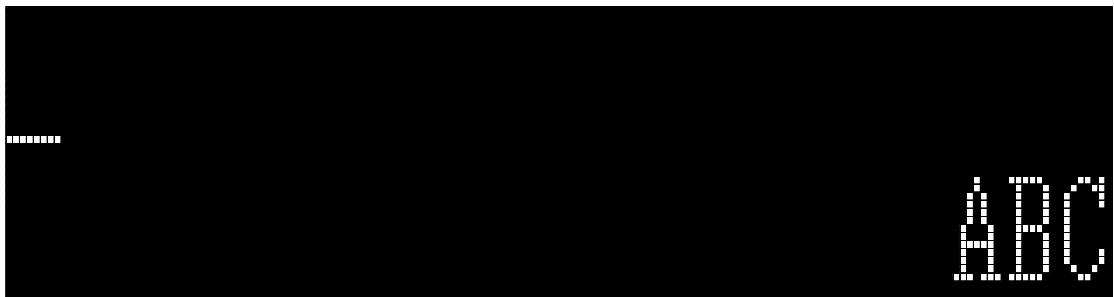

4-1-3. LINE FEED

Code: 0Ah

MSB

LSB

Table - 25

| Code | Byte | Bit7 | Bit6 | Bit5 | Bit4 | Bit3 | Bit2 | Bit1 | Bit0 | Note |
|------|------|------|------|------|------|------|------|------|------|------|
| 0Ah | 1st | 0 | 0 | 0 | 0 | 1 | 0 | 1 | 0 | |

Function: Moves the cursor down one line

If the cursor is in the lower line, the cursor moves to the same column on the upper.

機能: 1段下にカーソルを移動します。桁は同じ位置になります。カーソルが下段にあるとき、上段に移動します。

[Example]

//Before command is sent

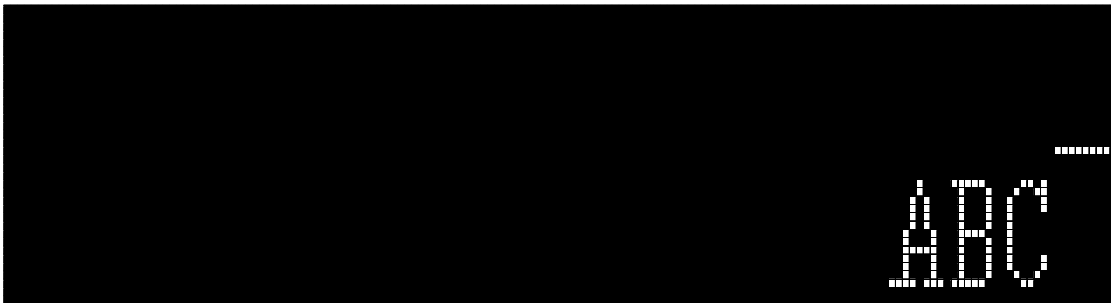

//Send command

Send(0Ah);

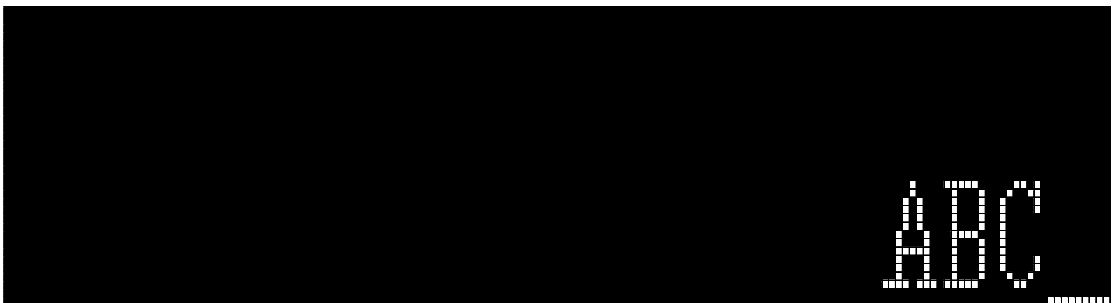

4-1-4. CARRIAGE RETURN

Code: 0Dh

MSB

LSB

Table - 26

| Code | Byte | Bit7 | Bit6 | Bit5 | Bit4 | Bit3 | Bit2 | Bit1 | Bit0 | Note |
|------|------|------|------|------|------|------|------|------|------|------|
| 0Dh | 1st | 0 | 0 | 0 | 0 | 1 | 1 | 0 | 1 | |

Function: Moves the cursor to the left-most position on current line.

機能: カーソルを現在ある段の左端に移動させます。

[Example]

//Before command is sent

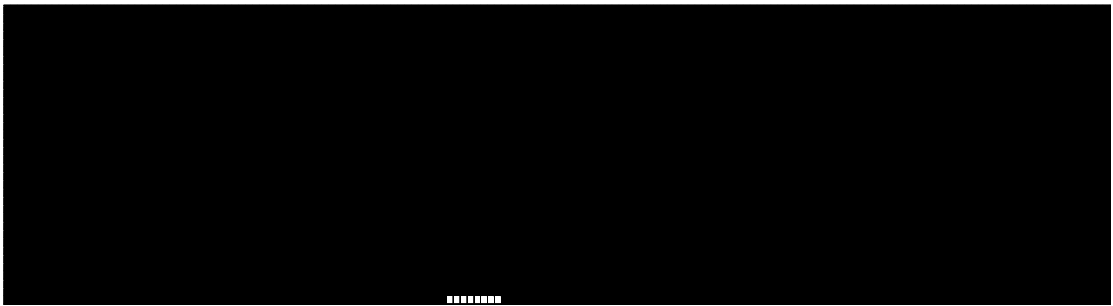

//Send command

Send(0Dh);

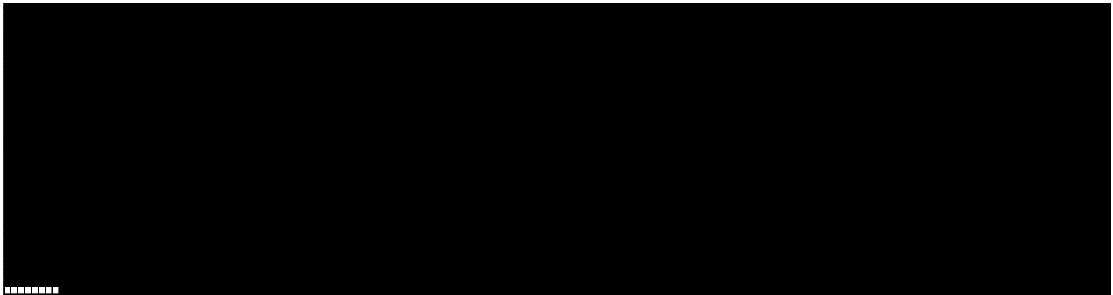

4-1-5. GRAPHIC MODE

Code: 1Bh, 20h, Pd...Pd

MSB

LSB

Table - 27

| Code | Byte | Bit7 | Bit6 | Bit5 | Bit4 | Bit3 | Bit2 | Bit1 | Bit0 | Note |
|---------|------|------|------|------|------|------|------|------|------|---------------|
| 1Bh | 1st | 0 | 0 | 0 | 1 | 1 | 0 | 1 | 1 | |
| 20h | 2nd | 0 | 0 | 1 | 0 | 0 | 0 | 0 | 0 | |
| Pd...Pd | 3rd~ | Pd | Pd | Pd | Pd | Pd | Pd | Pd | Pd | Pd1 ... Pd800 |

Function: Graphic display mode. The data will be start at (0,0) of display position.

機能: イメージデータをディスプレイに表示します。(0,0)の位置から描画します。

| | | | | | | | | | | | | |
|-----|-----|------|------|------|------|------|--------------|-------|-------|-------|-------|-------|
| MSB | LSB | Pd1 | Pd2 | Pd3 | Pd4 | Pd5 | 5 × 160 byte | Pd781 | Pd782 | Pd783 | Pd784 | Pd785 |
| | | Pd6 | Pd7 | Pd8 | Pd9 | Pd10 | | Pd786 | Pd787 | Pd788 | Pd789 | Pd790 |
| | | Pd11 | Pd12 | Pd13 | Pd14 | Pd15 | | Pd791 | Pd792 | Pd793 | Pd794 | Pd795 |
| | | Pd16 | Pd17 | Pd18 | Pd19 | Pd20 | | Pd796 | Pd797 | Pd798 | Pd799 | Pd800 |
| | | • | • | • | • | • | | • | • | • | • | • |

4-1-6. SET COUNTRY CODE

Code: 1Bh, 52h, n

| Code | Byte | MSB | | | | LSB | | | | Note |
|------|------|------|------|------|------|------|------|------|------|--|
| | | Bit7 | Bit6 | Bit5 | Bit4 | Bit3 | Bit2 | Bit1 | Bit0 | |
| 1Bh | 1st | 0 | 0 | 0 | 1 | 1 | 0 | 1 | 1 | |
| 52h | 2nd | 0 | 1 | 0 | 1 | 0 | 0 | 1 | 0 | |
| n | 3rd | 0 | 0 | n | n | n | n | n | n | $00h \leq n \leq 0Dh, 30h \leq n \leq 3Dh$ |

Table - 28

Function : Select international font set. (Please refer international Font Set Table.). $00h \leq n \leq 0Dh$. The default setting is 00h(USA) and 30h(PC437).

機能： フォントテーブルを $00(h) \leq n \leq 0D(h)$, $30(h) \leq n \leq 3D(h)$ から選択します。後述のフォントテーブルをご参照ください。電源投入時の初期設定は、00h(USA)、30h(PC437)です。

00h~0Dh: Character code 20h-7Fh

30h~3Dh: Character code 80h-FFh

Table - 29

| n | Country Code (20h – 7Fh) | n | Country Code (80h - FFh) |
|-----|--------------------------|-----|--|
| 00h | USA – default | 30h | PC437 (USA: Standard Europe) – default |
| 01h | France | 31h | Katakana |
| 02h | Germany | 32h | PC850 (Multilingual) |
| 03h | Great Britain | 33h | PC860 (Portuguese) |
| 04h | Denmark 1 | 34h | PC863(Canadian-French) |
| 05h | Sweden | 35h | Page 5 [PC865 (Norwegian)] |
| 06h | Italy | 36h | WPC1252 |
| 07h | Spain 1 | 37h | PC866 [Cyrillic #2] |
| 08h | Japan | 38h | PC852 [Latin 2] |
| 09h | Norway | 39h | Page 19 [PC858] |
| 0Ah | Denmark 2 | 3Ah | Japanese font(shift JIS) |
| 0Bh | Spain 2 | 3Bh | Simplified Chinese(GB2312) |
| 0Ch | Latin America | 3Ch | Traditional Chinese(Big5) |
| 0Dh | Korea | 3Dh | Hangul(KSC5601) |

4-1-7. DELETE TO END OF LINE

Code: 1Bh, 5Bh, 30h, 4Bh

MSB

LSB

Table – 30

| Code | Byte | Bit7 | Bit6 | Bit5 | Bit4 | Bit3 | Bit2 | Bit1 | Bit0 | Note |
|------|------|------|------|------|------|------|------|------|------|------|
| 1Bh | 1st | 0 | 0 | 0 | 1 | 1 | 0 | 1 | 1 | |
| 5Bh | 2nd | 0 | 1 | 0 | 1 | 1 | 0 | 1 | 1 | |
| 30h | 3rd | 0 | 0 | 1 | 1 | 0 | 0 | 0 | 0 | |
| 4Bh | 4th | 0 | 1 | 0 | 0 | 1 | 0 | 1 | 1 | |

Function: Clears the line containing the cursor.

After this command is executed, the cursor moves to the left-most position on the current line.

機能: カーソルのある段を消去します。

このコマンドを実行した後、カーソルは左端へ移動します。

[Example]

//Before command is sent



```

ABCDEFGHIJKLMNOPQRSTUVWXYZ
UVWXYZ1234567890+-*/
    
```

//Send command

`send(1Bh, 5Bh, 30h, 4Bh);`



```

ABCDEFGHIJKLMNOPQRSTUVWXYZ
.....
    
```

4-1-8. MODULE INFORMATION RESPONSE

Code: 1Bh, 5Bh, 30h, 63h

| Code | Byte | MSB | | | | LSB | | | | Note |
|------|-----------------|------|------|------|------|------|------|------|------|------|
| | | Bit7 | Bit6 | Bit5 | Bit4 | Bit3 | Bit2 | Bit1 | Bit0 | |
| 1Bh | 1st | 0 | 0 | 0 | 1 | 1 | 0 | 1 | 1 | |
| 5Bh | 2nd | 0 | 1 | 0 | 1 | 1 | 0 | 1 | 1 | |
| 30h | 3rd | 0 | 0 | 1 | 1 | 0 | 0 | 0 | 0 | |
| 63h | 4 th | 0 | 1 | 0 | 1 | 0 | 0 | 0 | 0 | |

Table - 31

Function: Module information response command.

The data send from this module is the below.

機能: モジュール情報をホストに送信するコマンドです。

本製品からホストに送信するデータは以下になります。

Table - 32

| Response data |
|--|
| 56h, 46h, 44h, 5Fh, 47h, 50h, 5Fh, 31h, 36h, 30h, 78h , 33h, 36h (VFD_GP_160x36) |

4-1-9. CLEAR SCREEN

Code: 1Bh, 5Bh, 32h, 4Ah

MSB

LSB

Table - 33

| Code | Byte | Bit7 | Bit6 | Bit5 | Bit4 | Bit3 | Bit2 | Bit1 | Bit0 | Note |
|------|------|------|------|------|------|------|------|------|------|------|
| 1Bh | 1st | 0 | 0 | 0 | 1 | 1 | 0 | 1 | 1 | |
| 5Bh | 2nd | 0 | 1 | 0 | 1 | 1 | 0 | 1 | 1 | |
| 32h | 3rd | 0 | 0 | 1 | 1 | 0 | 0 | 1 | 0 | |
| 4Ah | 4th | 0 | 1 | 0 | 0 | 1 | 0 | 1 | 0 | |

Function: Clears all displayed characters.

After this command is executed, the cursor moves to the home position.

機能: ディスプレイされている文字を全消去します。

このコマンドを実行した後、カーソルはホームポジションへ移動します。

[Example]

//Before command is sent



//Send command

Send(1Bh, 5Bh, 32h, 4Ah);

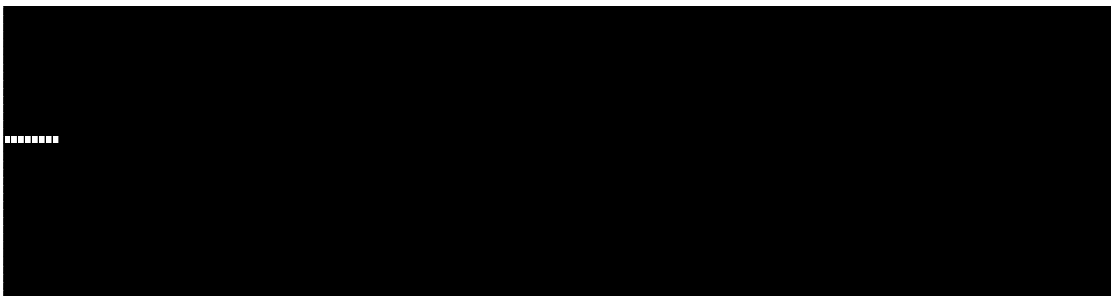

4-1-10. HOME POSITION

Code: 1Bh, 5Bh, 48h, 27h

MSB

LSB

Table - 34

| Code | Byte | Bit7 | Bit6 | Bit5 | Bit4 | Bit3 | Bit2 | Bit1 | Bit0 | Note |
|------|------|------|------|------|------|------|------|------|------|------|
| 1Bh | 1st | 0 | 0 | 0 | 1 | 1 | 0 | 1 | 1 | |
| 5Bh | 2nd | 0 | 1 | 0 | 1 | 1 | 0 | 1 | 1 | |
| 48h | 3rd | 0 | 1 | 0 | 0 | 1 | 0 | 0 | 0 | |
| 27h | 4th | 0 | 0 | 1 | 0 | 0 | 1 | 1 | 1 | |

Function: Moves the cursor to the left-most position on the upper line (home position).

The home position indicates the first column of the upper line.

機能: ホームポジションの位置にカーソルを移動します。

ホームポジションは、上段の最初の桁を示します。

[Example]

//Before command is sent



//Send command

Send(1Bh, 5Bh, 48h, 27h);

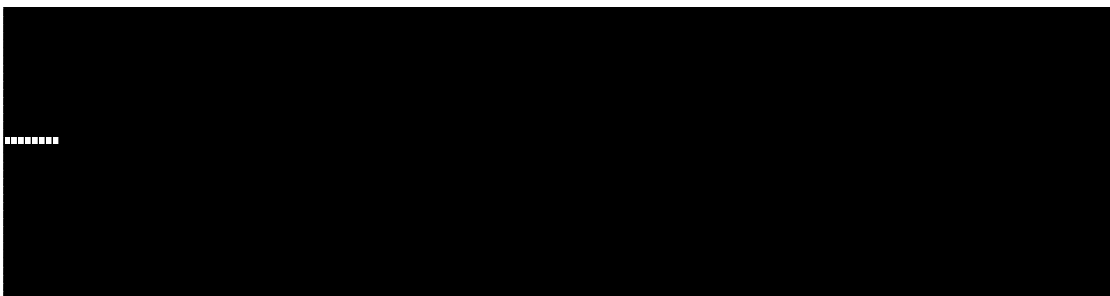

4-1-11. TURN ON/OFF DISPLAY

Code: 1Bh, 5Bh, n, 50h

| Code | Byte | MSB | | | | | | LSB | | Note |
|------|------|------|------|------|------|------|------|------|------|------------------------|
| | | Bit7 | Bit6 | Bit5 | Bit4 | Bit3 | Bit2 | Bit1 | Bit0 | |
| 1Bh | 1st | 0 | 0 | 0 | 1 | 1 | 0 | 1 | 1 | |
| 5Bh | 2nd | 0 | 1 | 0 | 1 | 1 | 0 | 1 | 1 | |
| n | 3rd | 0 | 0 | 0 | 0 | 0 | 0 | 0 | n | $00h \leq n \leq 01h.$ |
| 50h | 4th | 0 | 1 | 0 | 1 | 0 | 0 | 0 | 0 | |

| 3rd byte | Bit0 | Note |
|----------|------|----------------------|
| | 0 | Display OFF |
| | 1 | Display ON (Default) |

Function: VFD display ON/OFF control command. If n=0, VFD display is OFF, if n=1, VFD display is ON.

The state of display ON/OFF is valid until next command of power or soft reset.

機能: VFD表示のON/OFFを制御するコマンドです。n = 0 でVFD表示はOFF、n = 1 でVFD表示はONとなります。
ON/OFFの状態は再度このコマンドを送信するか、初期化されるまで継続します。

4-1-12. SPECIFIED POSITION

Code: 1Bh, 5Bh, Py, 3Bh, Px, 48h

| Code | Byte | MSB | | | | | LSB | | | | Note |
|------|------|------|------|------|------|------|------|------|------|--|------|
| | | Bit7 | Bit6 | Bit5 | Bit4 | Bit3 | Bit2 | Bit1 | Bit0 | | |
| 1Bh | 1st | 0 | 0 | 0 | 1 | 1 | 0 | 1 | 1 | | |
| 5Bh | 2nd | 0 | 1 | 0 | 1 | 1 | 0 | 1 | 1 | | |
| Py | 3rd | 0 | 0 | 0 | 0 | 0 | 0 | Py | Py | $01h \leq Py(\text{column}) \leq 02h.$ | |
| 3Bh | 4th | 0 | 0 | 1 | 1 | 1 | 0 | 1 | 1 | | |
| Px | 5th | 0 | 0 | 0 | Px | Px | Px | Px | Px | $01h \leq Px(\text{row}) \leq 14h.$ | |
| 48h | 6th | 0 | 1 | 0 | 0 | 1 | 0 | 0 | 0 | | |

| 2nd byte | Bit2 | Bit1 | Bit0 | Start write on top position |
|----------|------|------|------|-----------------------------|
| | 0 | 0 | 1 | 01h |
| | 0 | 1 | 0 | 02h |

| 5th byte | Bit7 | Bit6 | Bit5 | Bit4 | Bit3 | Bit2 | Bit1 | Bit0 | Start write on left position |
|----------|------|------|------|------|------|------|------|------|------------------------------|
| | 0 | 0 | 0 | 0 | 0 | 0 | 0 | 1 | 01h |
| | 0 | 0 | 0 | 0 | 0 | 0 | 1 | 0 | 02h |
| | : | | | | | | | | |
| | 0 | 0 | 0 | 1 | 0 | 0 | 1 | 1 | 13h |
| | 0 | 0 | 0 | 1 | 0 | 1 | 0 | 0 | 14h |

Function: Moves the cursor to the x th position on the y th line.

If the command specifies a value for n or m that exceeds the range, this command is ignored, and the cursor is not moved.

機能: Py段のPx桁目の位置にカーソルを移動します。

コマンドが範囲を超えたPy、Pxの値を指定している場合、このコマンドは無視されカーソルは移動しません。

4-1-13. CURSOR MODE

Code: 1Bh, 5Ch, 3F, 4Ch, 43, Ps

MSB

LSB

Table - 37

| Code | Byte | Bit7 | Bit6 | Bit5 | Bit4 | Bit3 | Bit2 | Bit1 | Bit0 | Note |
|------|------|------|------|------|------|------|------|------|------|-------------------------|
| 1Bh | 1st | 0 | 0 | 0 | 1 | 1 | 0 | 1 | 1 | |
| 5Ch | 2nd | 0 | 1 | 0 | 1 | 1 | 1 | 0 | 0 | |
| 3Fh | 3rd | 0 | 0 | 1 | 1 | 1 | 1 | 1 | 1 | |
| 4Ch | 4th | 0 | 1 | 0 | 0 | 1 | 0 | 1 | 1 | |
| 43h | 5th | 0 | 1 | 0 | 0 | 0 | 0 | 1 | 1 | |
| Ps | 6th | 0 | 0 | 0 | 0 | 0 | 0 | Ps | Ps | $00h \leq Ps \leq 02h.$ |

| 6th byte | Bit1 | Bit0 | Start write on top position |
|----------|------|------|-----------------------------------|
| | 0 | 0 | Ps = 00h: Cursor OFF (Default) |
| | 0 | 1 | Ps = 01h: Cursor blink |
| | 1 | 0 | Ps = 02h: Cursor ON |

Function: Selects or cancels the cursor display.

When Ps = 1, the cursor blinks. When Ps = 2, the cursor will continue to light up. Cursor at Ps = 0 will turn off.

機能: カーソルの表示・非表示を設定します。

Ps = 1のとき、カーソルは点滅します。Ps = 2のとき、カーソルは点灯し続けます。Ps = 0でカーソルは消灯します。

4-1-14. LCD CONTRAST & VFD BRIGHTNESS

Code: 1Bh, 5Ch, 3Fh, 4Ch, 44h, Pc, Pb

| Code | Byte | MSB | | | | | LSB | | | | Note |
|------|------|------|------|------|------|------|------|------|------|--------------------------|------|
| | | Bit7 | Bit6 | Bit5 | Bit4 | Bit3 | Bit2 | Bit1 | Bit0 | | |
| 1Bh | 1st | 0 | 0 | 0 | 1 | 1 | 0 | 1 | 1 | | |
| 5Ch | 2nd | 0 | 1 | 0 | 1 | 1 | 1 | 0 | 0 | | |
| 3Fh | 3rd | 0 | 0 | 1 | 1 | 1 | 1 | 1 | 1 | | |
| 4Ch | 4th | 0 | 1 | 0 | 0 | 1 | 1 | 0 | 0 | | |
| 44h | 5th | 0 | 1 | 0 | 0 | 0 | 1 | 0 | 0 | | |
| Pc | 6th | 0 | 0 | 0 | 0 | 0 | Pc | Pc | Pc | $00h \leq Pc \leq 06h$ ※ | |
| Pb | 7th | 0 | 0 | 0 | 0 | 0 | 0 | Pb | Pb | $00h \leq Pb \leq 03h$ | |

Function: LCD contrast and VFD brightness adjustment.

Pc set up the LCD contrast. (Table-39)

Pb set up the VFD brightness. (Table-40)

※This module doesn't set up LCD contrast. Please set the Pc = 03h.

機能: LCDのコントラストとVFDの輝度を設定します。

LCDのコントラストは、Pcの値で設定します。(Table-39)

VFDの輝度は、Pbの値で設定します。(Table-40)

※本品種ではLCDのコントラスト設定を使用しないため、Pcの値はPc=03hと設定してください。

Table -39

| Pc | LCD Contrast |
|-----|---------------|
| 00h | -3 |
| 01h | -2 |
| 02h | -1 |
| 03h | 0 (Default) ※ |
| 04h | +1 |
| 05h | +2 |
| 06h | +3 |

Table - 40

| Pb | VFD Brightness (%) |
|-----|--------------------|
| 00h | 20 |
| 01h | 40 |
| 02h | 60 |
| 03h | 100 (Default) |

4-1-15. SINGLE LINE SCROLL SETTING

Code: 1Bh, 5Ch, 3Fh, 4Ch, 48h, Pl, Pt, Pd ... 00h

MSB

LSB

Table -41

| Code | Byte | Bit7 | Bit6 | Bit5 | Bit4 | Bit3 | Bit2 | Bit1 | Bit0 | Note |
|------|------------------|------|------|------|------|------|------|------|------|---|
| 1Bh | 1st | 0 | 0 | 0 | 1 | 1 | 0 | 1 | 1 | |
| 5Ch | 2nd | 0 | 1 | 0 | 1 | 1 | 1 | 0 | 0 | |
| 3Fh | 3rd | 0 | 0 | 1 | 1 | 1 | 1 | 1 | 1 | |
| 4Ch | 4th | 0 | 1 | 0 | 0 | 1 | 1 | 0 | 0 | |
| 48h | 5th | 0 | 1 | 0 | 1 | 1 | 0 | 0 | 0 | |
| Pl | 6th | 0 | 0 | 0 | 0 | 0 | 0 | Pl | Pl | 01h ≤ Pl ≤ 02h. |
| Pt | 7th | 0 | 0 | Pt | Pt | 0 | 0 | Pt | Pt | 30h ≤ Pt ≤ 33h. |
| Pd | 8th~ variable | Pd | Pd | Pd | Pd | Pd | Pd | Pd | Pd | スクロール文字データ Scroll character data (max. 256 bytes) |
| 00h | variable | 0 | 0 | 0 | 0 | 0 | 0 | 0 | 0 | コマンド終了 |

Function: Set single line scroll data, start / cancel scrolling.

Scrolling starts from the right end of the line and moves to the left end.

Scroll is started by setting character data Pd setting and command end (00h).

Scroll is canceled by setting no character data Pd setting and command end (00h).

The maximum number of bytes of characters is 256 (FFh) bytes.

The number of bytes of the scroll character is counted with half size = 1, full width = 2.

機能: シングルラインスクロールデータを設定、スクロールの開始、解除を実行します。

スクロールは、行の右端から表示を開始し、左端へ移動します。

文字データ Pd 設定あり、コマンド終了(00h)を設定することでスクロールを開始します。

文字データ Pd 設定なし、コマンド終了(00h)を設定することでスクロールは解除されます。

文字のバイト数は最大 256(FFh)バイトになります。スクロール文字のバイト数は、半角=1、全角=2 でカウントを行います。

| | |
|---|--|
| Pl: スクロール行 Pl: Scroll line | スクロールする行番号を指定します。 Scroll line number setting. 1 line : 01h 2 line : 02h |
| Pt: スクロール速度[msec/dot] Pt: Scroll speed | スクロールする速度を設定します。 Scroll speed setting. 30h = 1 scan 1dot scroll (Approx. 10ms/dot) 31h = 2 scan 1dot scroll (Approx.20ms/dot) 32h = 3 scan 1dot scroll (Approx.30ms/dot) 33h = 4 scan 1dot scroll (Approx.40ms/dot) ※スクロール速度は目安となりディスプレイのスキャンに依存します。 Scroll speed is a guide. It depends on the scan of the display. |
| Pd: スクロール文字データ Pd: Scroll character data | スクロールする文字データを設定します。(max. 256バイト) Scroll character data setting.(max. 256 bytes) |

[Example]

//Before command is sent



//Send command (Scroll start "DEF")

Send(1Bh, 5Ch, 3Fh, 4Ch, 48h 01h 30h 44h 45h 46h 00h);

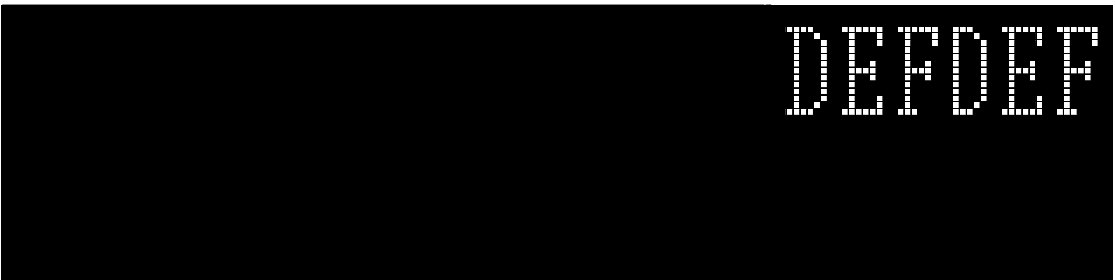

//Send command (Scroll end)

Send(1Bh, 5Ch, 3Fh, 4Ch, 48h, 01h, 30h, 00h);

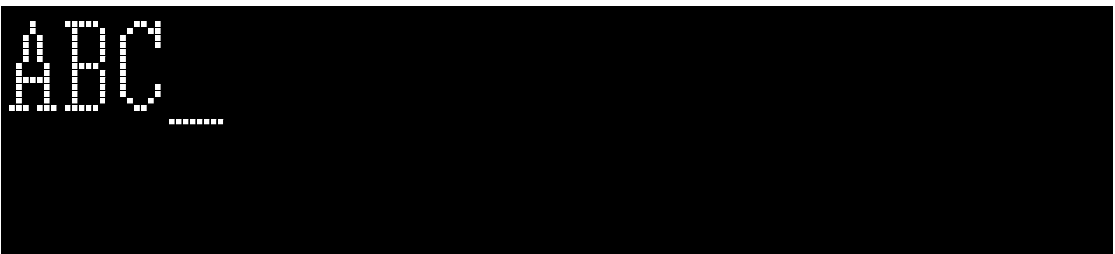

4-1-16. USER DEFINED CHARACTERS

Code: 1Bh, 5Ch, 3Fh, 4Ch, 57h, Pf, 3Bh, Pn, 3Bh, Pc, 3Bh, Pd ...

Table - 42

| Code | Byte | MSB | | | | | LSB | | | | Note |
|------|-------|------|------|------|------|------|------|------|------|--|------|
| | | Bit7 | Bit6 | Bit5 | Bit4 | Bit3 | Bit2 | Bit1 | Bit0 | | |
| 1Bh | 1st | 0 | 0 | 0 | 1 | 1 | 0 | 1 | 1 | | |
| 5Ch | 2nd | 0 | 1 | 0 | 1 | 1 | 1 | 0 | 0 | | |
| 3Fh | 3rd | 0 | 0 | 1 | 1 | 1 | 1 | 1 | 1 | | |
| 4Ch | 4th | 0 | 1 | 0 | 0 | 1 | 1 | 0 | 0 | | |
| 57h | 5th | 0 | 1 | 0 | 1 | 0 | 1 | 1 | 1 | | |
| Pf | 6th | 0 | 0 | 0 | 0 | 0 | 0 | Pf | Pf | 01h ≤ Pf ≤ 02h. | |
| 3Bh | 7th | 0 | 0 | 1 | 1 | 1 | 0 | 1 | 1 | | |
| Pn | 8th | 0 | 0 | 0 | Pn | Pn | Pn | Pn | Pn | 00h ≤ Pn ≤ 1Fh (Pf = 01h) 00h ≤ Pn ≤ 0Fh (Pf = 02h) | |
| 3Bh | 9th | 0 | 0 | 1 | 1 | 1 | 0 | 1 | 1 | | |
| Pc | 10th | Pc | Pc | Pc | Pc | Pc | Pc | Pc | Pc | 20h ≤ Pc ≤ 7Fh (Pf = 01h) ※ 80 00h ≤ Pc ≤ FF FFh (Pf = 02h) | |
| 3Bh | 11th | 0 | 0 | 1 | 1 | 1 | 0 | 1 | 1 | | |
| Pd | 12th~ | Pd | Pd | Pd | Pd | Pd | Pd | Pd | Pd | 16 byte or 32byte | |

Function: Defines user-defined characters.

User-defined character that was defined will be displayed by the character code of the Pc. User-defined character font data to be secured on the RAM, are cleared by power-off. The maximum number of characters that can be registered in each font size is below. If the user-defined character is already registered in the specified font number, to release that character and make a new user-defined character.

Pf = 01h: One-byte character 8×16 → Maximum 32 characters

Pf = 02h: Two-byte character 16×16 → Maximum 16 characters

•Font size (Pf = 1), if you specify the 00h to the character code(Pc), and then release the user-defined character that is registered with the given font number. Font size (Pf = 2), if you specify the 00h 00h to the character code(Pc), and then release the user-defined character that is registered with the given font number.

Pf = 1 (01h) : 1Bh, 5Ch, 3Fh, 4Ch, 57h, Pf, 3Bh, Pn, 3Bh, 00h, 3Bh

Pf = 2 (02h) : 1Bh, 5Ch, 3Fh, 4Ch, 57h, Pf, 3Bh, Pn, 3Bh, 00h, 00h, 3Bh

機能: 外字を定義します。

定義した外字は Pc の文字コードにより表示されます。外字フォントデータは RAM 上に確保されるため、電源遮断により消去されます。各フォントサイズで登録できる最大の文字数は以下となります。指定されたフォント番号に既に外字が登録されている場合、登録されている外字を解除し新たに外字登録を行います。

Pf = 1(01H) : 半角 8×16 最大 32 文字

Pf = 2(02H) : 全角 16×16 最大 16 文字

•文字コード(Pc)に 00h (Pf = 1) 指定した場合、指定されたフォント番号に登録されている外字を解除します。

Pf = 1 (01h) : 1Bh, 5Ch, 3Fh, 4Ch, 57h, Pf, 3Bh, Pn, 3Bh, 00h, 3Bh

Pf = 2 (02h) : 1Bh, 5Ch, 3Fh, 4Ch, 57h, Pf, 3Bh, Pn, 3Bh, 00h, 00h, 3Bh

| | |
|----------------------------------|--|
| <i>Pf</i> : Font size フォントサイズ | Pf = 01h : One-byte character 8×16 dot Pf = 02h : Two-byte character 16×16 dot |
| <i>Pn</i> : Font number フォント番号 | 00h ≤ Pn ≤ 1Fh (Pf = 01h) 00h ≤ Pn ≤ 0Fh (Pf = 02h) |
| <i>Pc</i> : Character code 文字コード | 20h ≤ Pc ≤ 7Fh (Pf = 01h) ※4-1-12. SET COUNTRY CODEが3A(shiftJIS)の場合、以下の範囲が追加されます。 A0h ≤ Pc ≤ DFh (Pf = 01h) 80 00h ≤ Pc ≤ FF FFh (Pf = 02h) |
| <i>Pd</i> : Font data フォントデータ | 16 byte (<i>Pf</i> = 01h) 32 byte (<i>Pf</i> = 02h) |

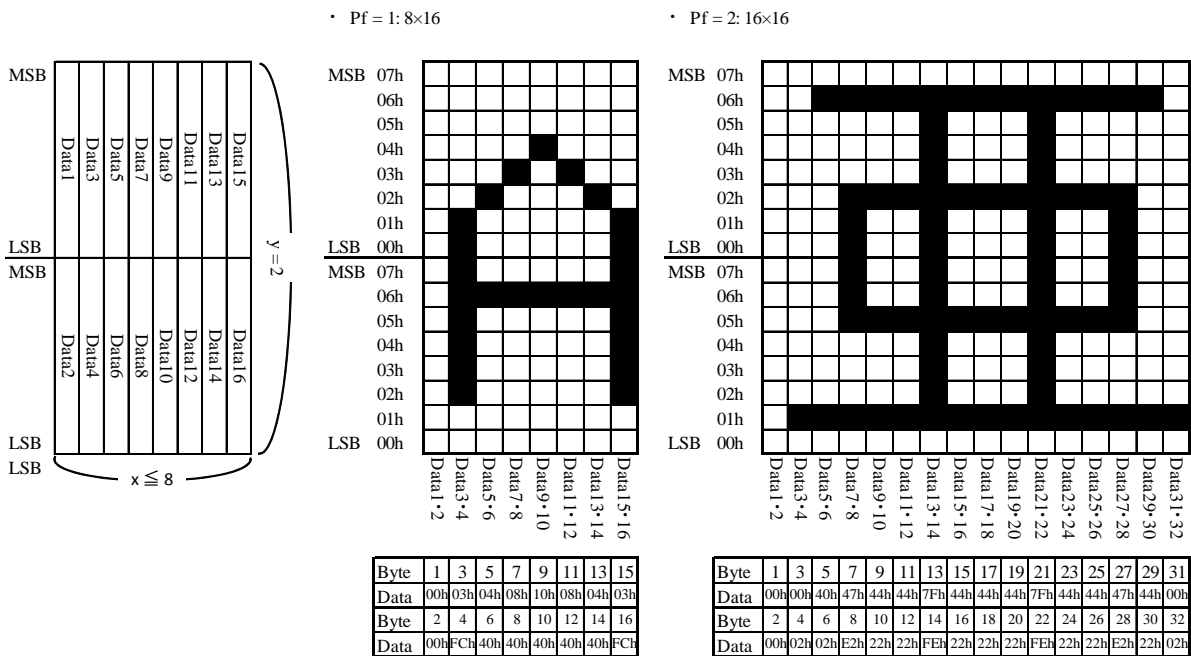

5. コネクタ接続 CONECTER CONNECTION

5-1. RS232C TYPE (AH145AA/BA)

本体 CN1 : HEC3650-018010 EIAJ-2 or equivalent

CN2 : DSB5-09M1-KNR0-02 D-SUB 9pin male connector or equivalent

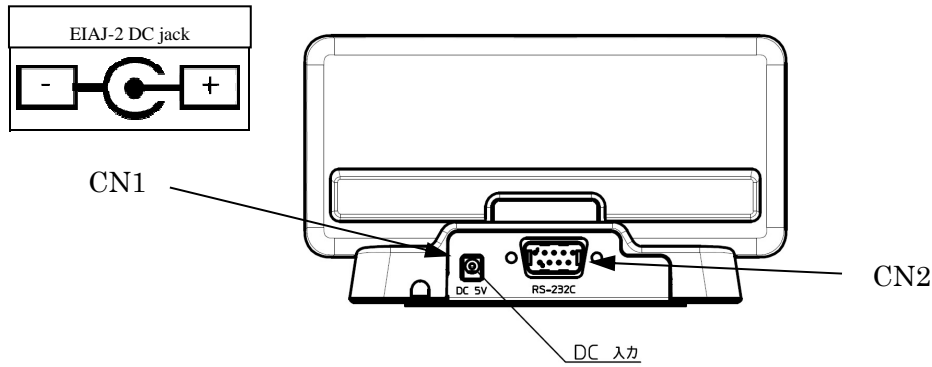

CN2 PIN 配置

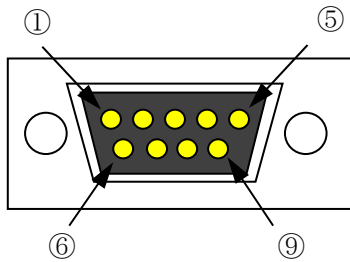

| ピン番号 PIN NO. | 信号名 Signal Name |
|-----------------|--------------------|
| 1 | — |
| 2 | RxD |
| 3 | TxD |
| 4 | — |
| 5 | GND |
| 6 | — |
| 7 | RTS |
| 8 | CTS |
| 9 | — |

5-2. USB TYPE (AH145AB/BB)

本体 CN1 : UX60SC-MB-5ST USB Mini-B female connector or equivalent

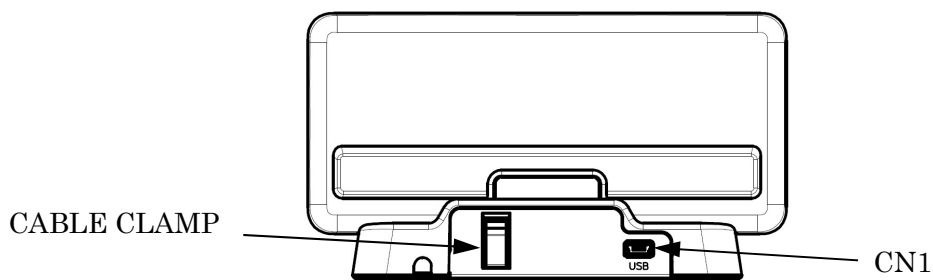

CN1 PIN 配置

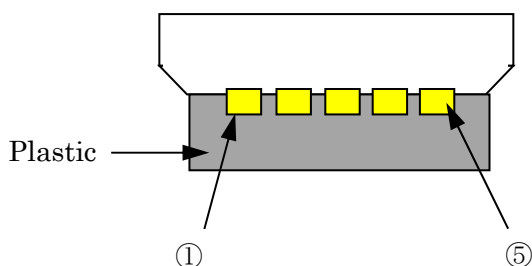

| ピン番号 PIN NO. | 信号名 Signal Name |
|-----------------|--------------------|
| 1 | Vcc (Vbus) |
| 2 | D- |
| 3 | D+ |
| 4 | NC |
| 5 | GND |

CABLE SPECIFICATION

線径 (Vbus,GND) : AWG24
 線径 (D+,D-) : AWG28
 色 : 白と黒の2種類
 MINIBコネクタ: レフトアングル
 TYPEAコネクタ: ストレート

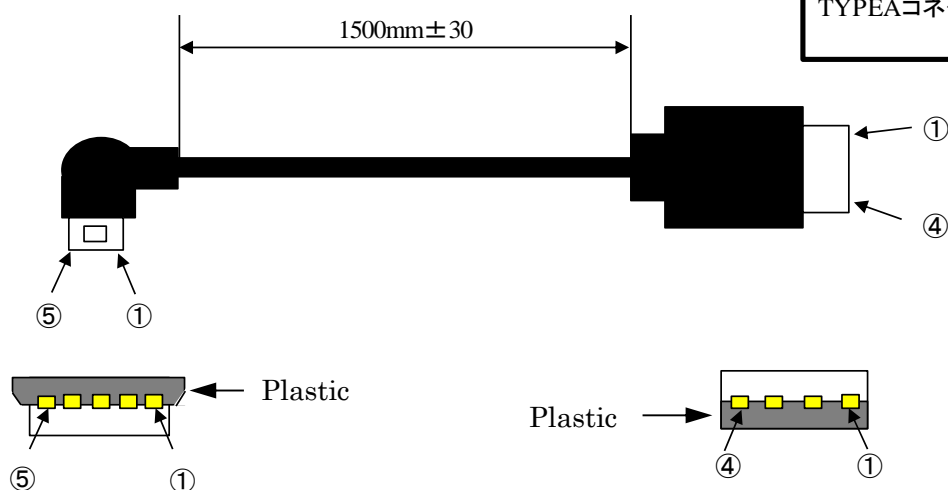

| USB Mini-B | | USB Type A | |
|------------|-------------|------------|-------------|
| PIN no. | Signal name | PIN no. | Signal name |
| 1 | Vcc(Vbus) | 1 | Vcc(Vbus) |
| 2 | D- | 2 | D- |
| 3 | D+ | 3 | D+ |
| 4 | NC | 4 | GND |
| 5 | GND | SEHLL | FGND |
| SHELL | FGND | | |

5-3. BLUETOOTH (IAP) TYPE (AH145AC/BC)

本体 CN1 : UX60SC-MB-5ST USB Mini-B female connector or equivalent

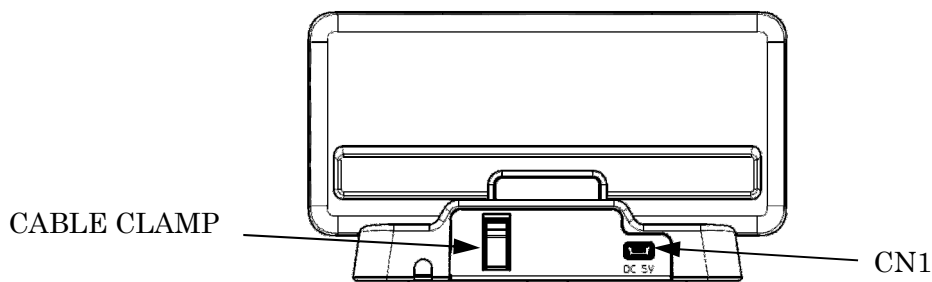

CN1 PIN 配置

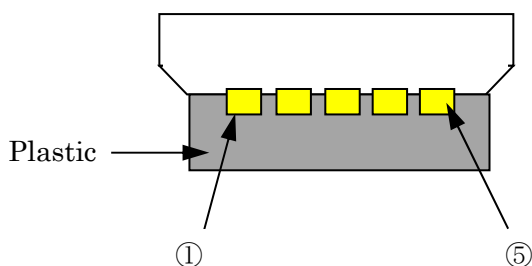

| ピン番号 PIN NO. | 信号名 SIGNAL NAME |
|-----------------|--------------------|
| 1 | Vcc (Vbus) |
| 2 | NC (D-) |
| 3 | NC (D+) |
| 4 | NC |
| 5 | GND |

CABLE SPECIFICATION

線径 (Vbus,GND) : AWG24
 線径 (D+,D-) : AWG28
 色 : 白と黒の2種類
 MINIBコネクタ: レフトアングル
 TYPEAコネクタ: ストレート

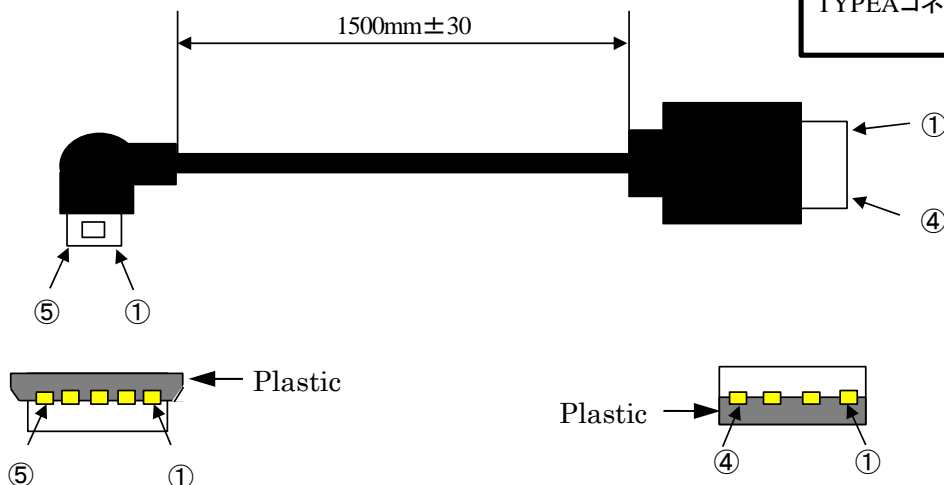

| USB Mini-B | | USB Type A | |
|------------|-------------|------------|-------------|
| PIN no. | Signal name | PIN no. | Signal name |
| 1 | Vcc(Vbus) | 1 | Vcc(Vbus) |
| 2 | D- | 2 | D- |
| 3 | D+ | 3 | D+ |
| 4 | NC | 4 | GND |
| 5 | GND | SEHLL | FGND |
| SHELL | FGND | | |

Outer Dimensions

FIGURE-1

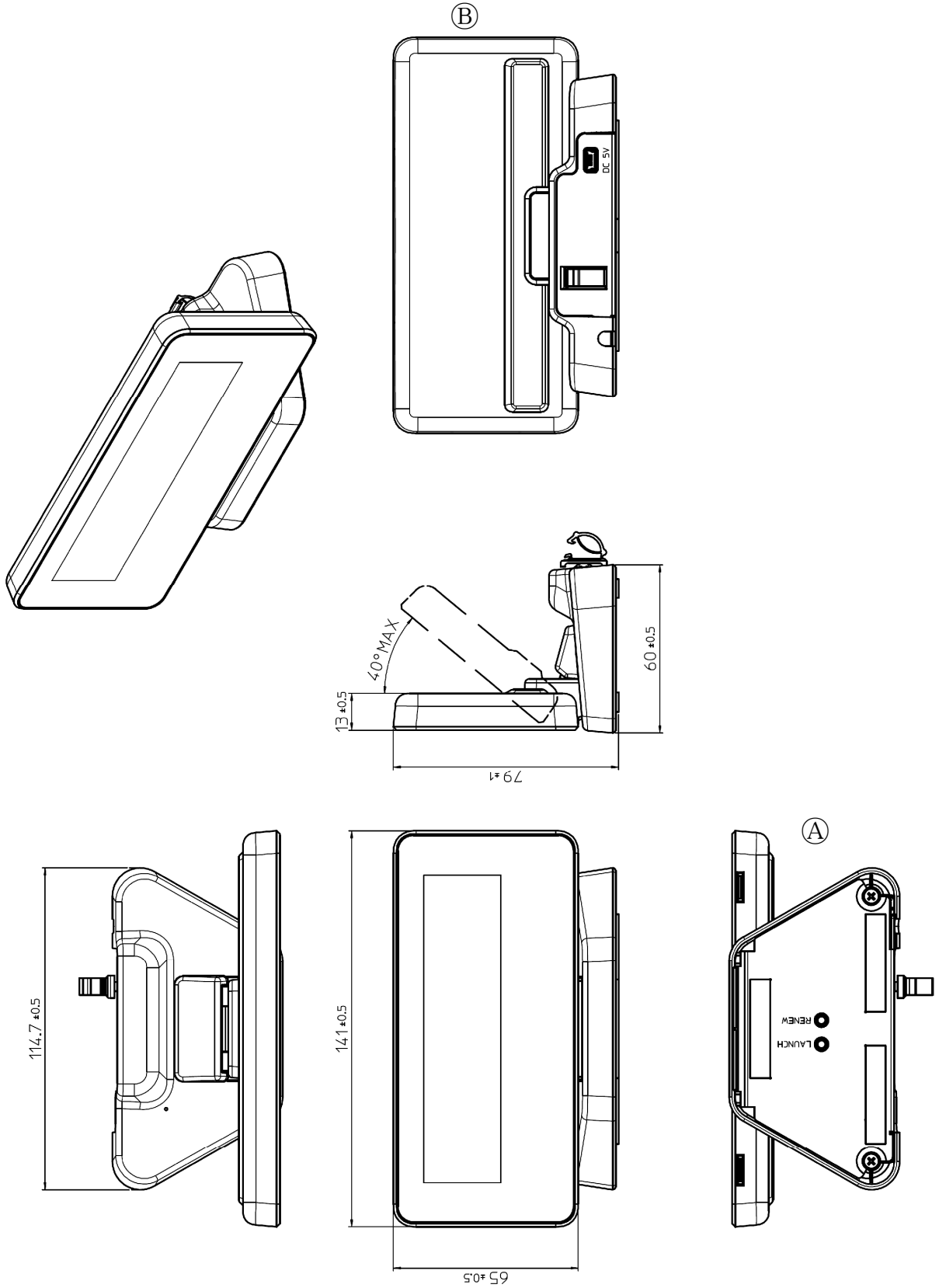

Outer Dimensions

FIGURE-2

RS232C TYPE (AH145AA/BA)

Ⓐ

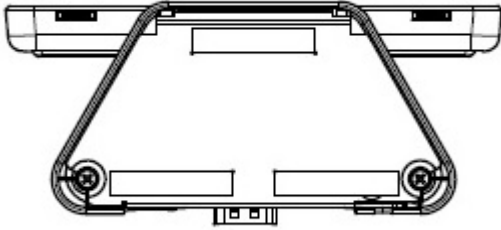

Ⓑ

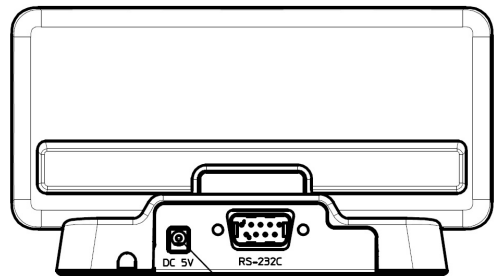

DC 5V

USB TYPE (AH145AB/BB)

Ⓐ

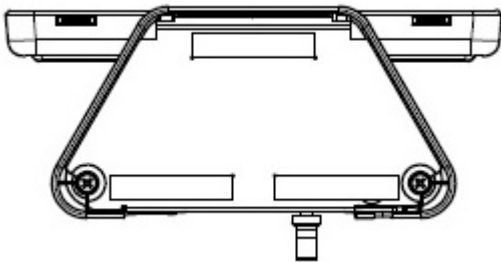

Ⓑ

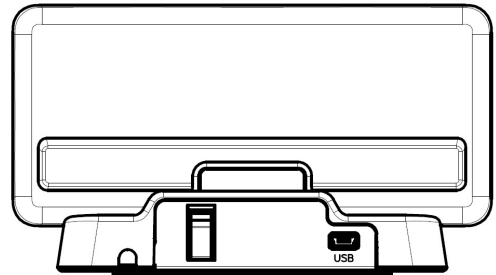

BLUETOOTH (IAP) TYPE (AH145AC/BC)

Ⓐ

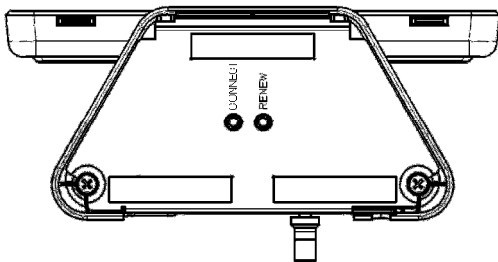

Ⓑ

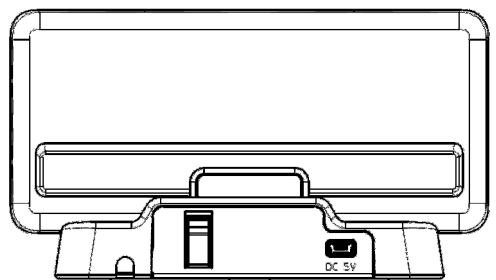

RS232C Type (AH145AA/BA) Block Diagram

FIGURE-3

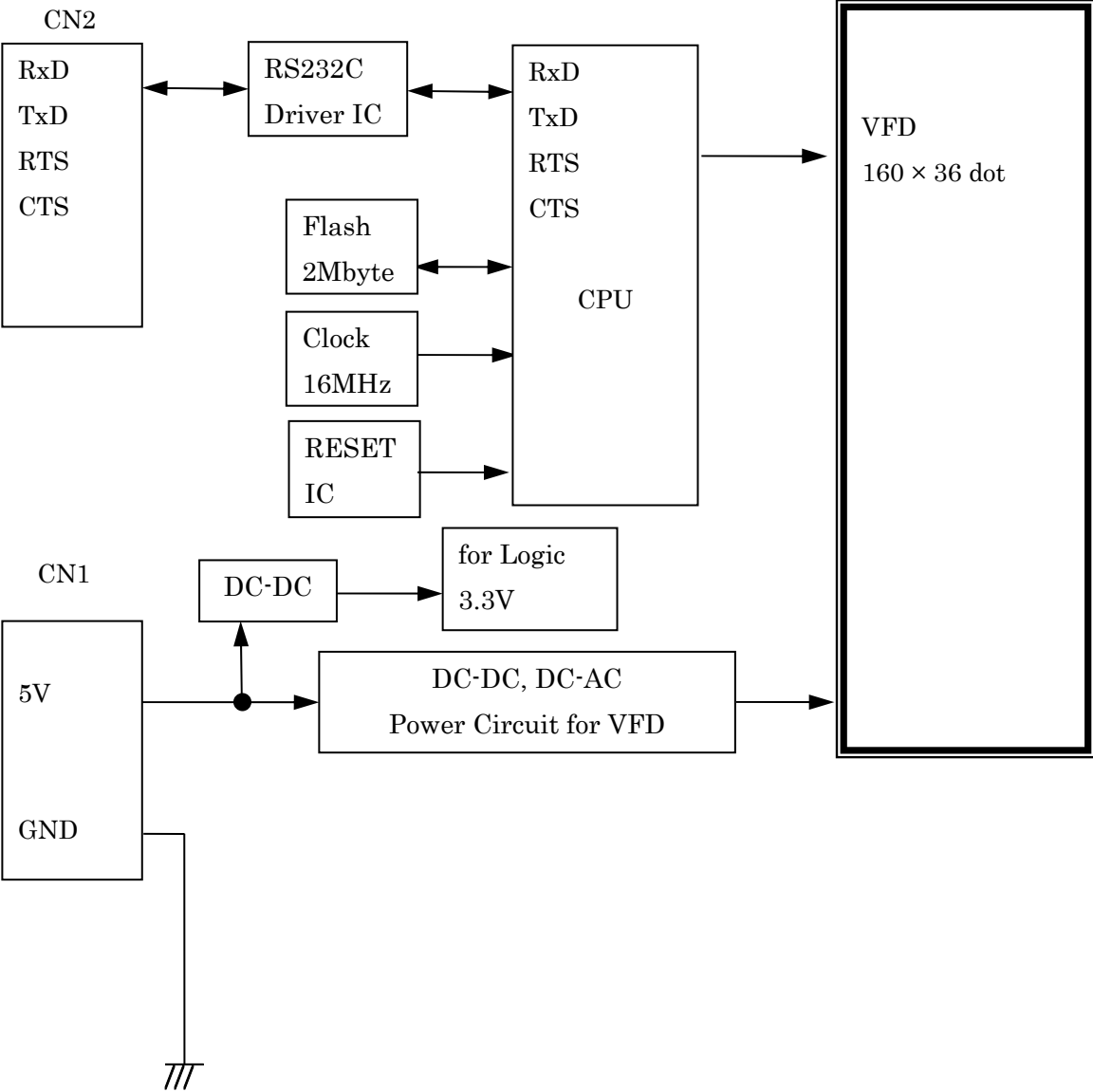

USB Type (AH145AB/BB) Block Diagram

FIGURE-4

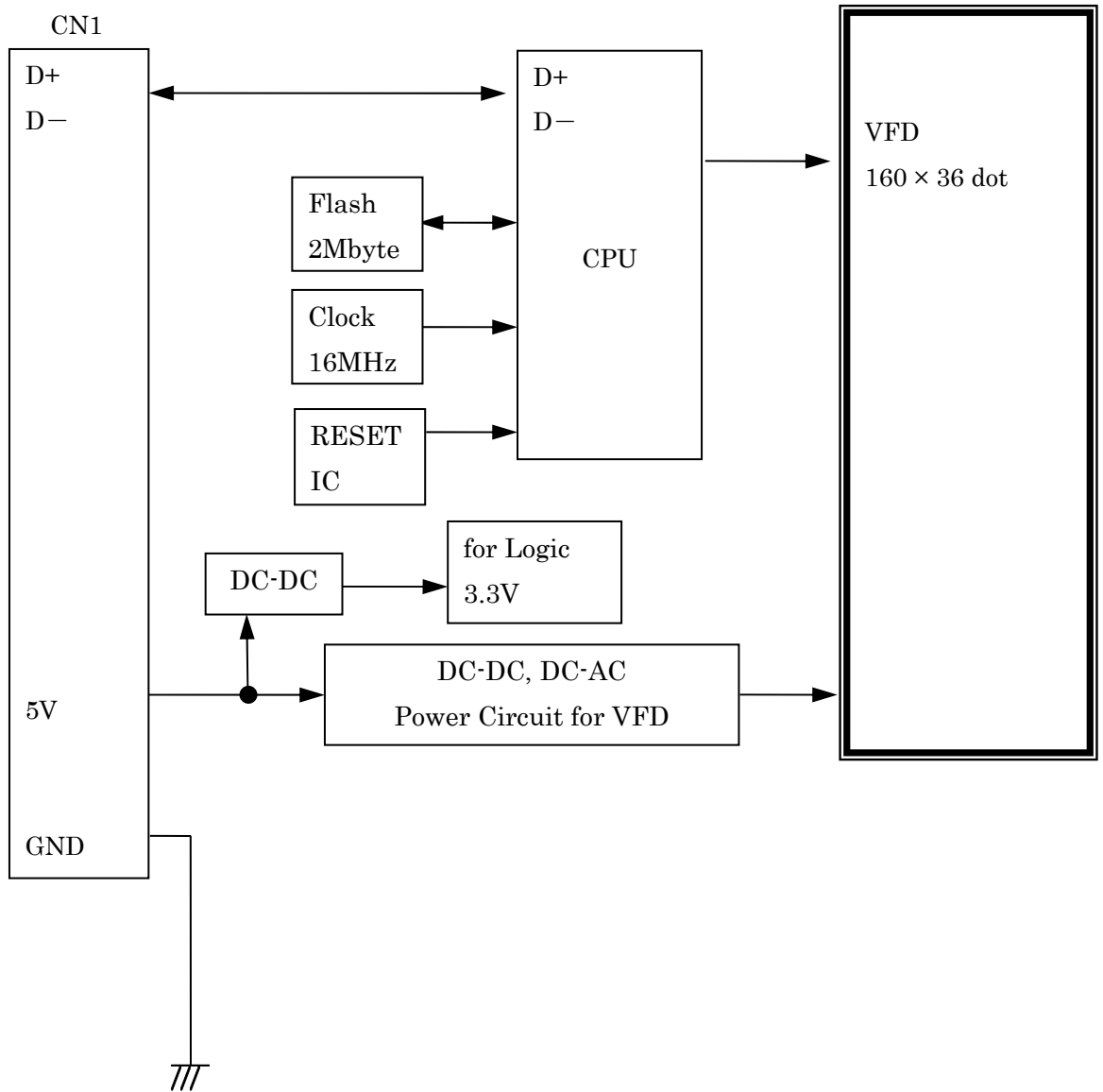

BLUETOOTH(IAP) Type (AH145AC/BC) Block Diagram

FIGURE-5

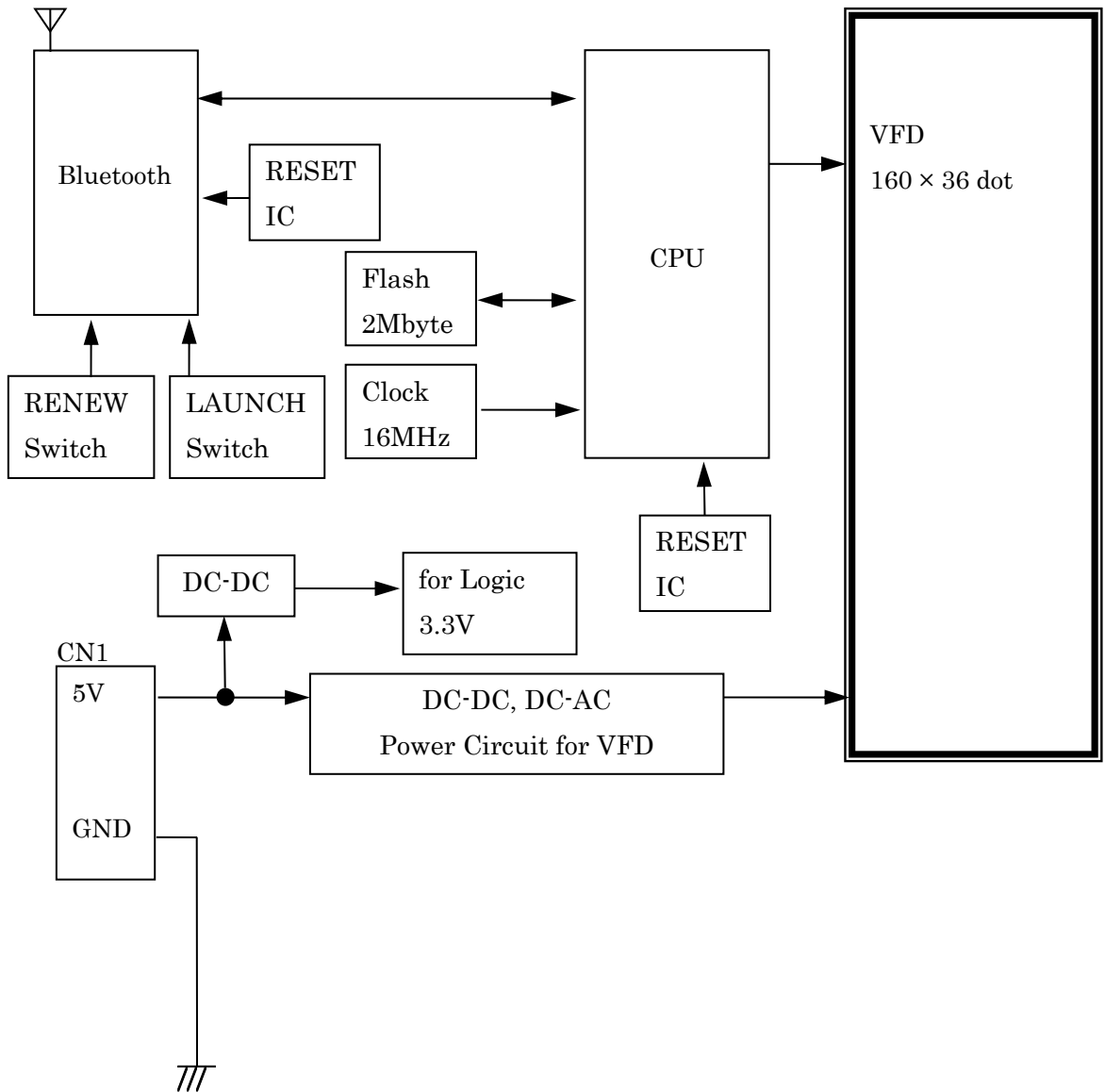

Font Tables

8x16 dot font

Common font

| | | | | | | | | | | | | | | | | |
|---|---|---|---|---|----|---|---|---|---|---|---|---|---|---|---|---|
| | 0 | 1 | 2 | 3 | 4 | 5 | 6 | 7 | 8 | 9 | A | B | C | D | E | F |
| 2 | | ! | " | # | \$ | % | & | ' | (|) | * | + | , | - | . | / |
| 3 | Ø | 1 | 2 | 3 | 4 | 5 | 6 | 7 | 8 | 9 | : | ; | < | = | > | ? |
| 4 | @ | A | B | C | D | E | F | G | H | I | J | K | L | M | N | O |
| 5 | P | Q | R | S | T | U | V | W | X | Y | Z | [| \ |] | ^ | _ |
| 6 | ` | a | b | c | d | e | f | g | h | i | j | k | l | m | n | o |
| 7 | p | q | r | s | t | u | v | w | x | y | z | { | | } | ~ | |

International font set

| | | | | | | | | | | | | |
|----|----|----|----|----|----|----|----|----|----|----|----|----|
| n | 23 | 24 | 40 | 5B | 5C | 5D | 5E | 60 | 7B | 7C | 7D | 7E |
| 00 | # | \$ | @ | [| \ |] | ^ | ` | { | | } | ~ |
| 01 | # | \$ | à | ° | ç | š | ^ | ` | é | ù | è | ˘ |
| 02 | # | \$ | š | Ä | Ö | Ü | ^ | ` | ä | ö | ü | ß |
| 03 | £ | \$ | @ | [| \ |] | ^ | ` | { | | } | ~ |
| 04 | # | \$ | @ | Æ | Ø | Å | ^ | ` | æ | ø | å | ~ |
| 05 | # | ¤ | É | Ä | Ö | Å | Ü | é | ä | ö | å | ü |
| 06 | # | \$ | @ | ° | \ | é | ^ | ù | à | ò | è | ì |
| 07 | £ | \$ | @ | ı | Ñ | ¿ | ^ | ` | ˘ | ñ | } | ~ |
| 08 | # | \$ | @ | [| ¥ |] | ^ | ` | { | | } | ~ |
| 09 | # | ¤ | É | Æ | Ø | Å | Ü | é | æ | ø | å | ü |
| 0A | # | \$ | É | Æ | Ø | Å | Ü | é | æ | ø | å | ü |
| 0B | # | \$ | á | ı | Ñ | ¿ | é | ` | í | ñ | ó | ú |
| 0C | # | \$ | á | ı | Ñ | ¿ | é | ü | í | ñ | ó | ú |
| 0D | # | \$ | @ | [| ¶ |] | ^ | ` | { | | } | ~ |

n=30h

| | 0 | 1 | 2 | 3 | 4 | 5 | 6 | 7 | 8 | 9 | A | B | C | D | E | F |
|---|---|---|---|---|---|---|---|---|---|---|---|---|---|---|---|---|
| 8 | Ç | ü | é | â | ã | à | å | ç | ê | ë | è | ī | î | ì | Ä | Å |
| 9 | É | æ | Æ | ô | ö | ò | û | ù | ÿ | Ö | Ü | Φ | £ | ¥ | ℞ | f |
| A | á | í | ó | ú | ñ | Ñ | æ | ø | ¿ | ¬ | ½ | ¼ | ¡ | « | » | |
| B | ▯ | ▯ | ▯ | | ├ | ┤ | ┥ | ┦ | ┧ | ┨ | ┩ | ┪ | ┫ | ┬ | ┭ | |
| C | ┮ | ┯ | ┰ | ┱ | ┲ | ┳ | ┴ | ┵ | ┶ | ┷ | ┸ | ┹ | ┺ | ┻ | ┼ | |
| D | ┽ | ┿ | ┼ | ┼ | ┼ | ┼ | ┼ | ┼ | ┼ | ┼ | ■ | ■ | ■ | ■ | ■ | |
| E | α | β | Γ | π | Σ | σ | μ | τ | Φ | Θ | Ω | δ | ∞ | φ | ε | ∩ |
| F | ≡ | ± | ≥ | ≤ | ∫ | ∫ | ÷ | ≈ | ° | · | · | √ | n | 2 | ■ | |

n=31h

| | 0 | 1 | 2 | 3 | 4 | 5 | 6 | 7 | 8 | 9 | A | B | C | D | E | F |
|---|---|---|---|---|---|---|---|---|---|---|---|---|---|---|---|---|
| 8 | ▬ | ▬ | ▬ | ▬ | ▬ | ▬ | ▬ | ▬ | ▬ | ▬ | ▬ | ▬ | ▬ | | ▬ | ▬ |
| 9 | | ▬ | ▬ | ▬ | ▬ | ▯ | ▯ | → | ← | ↑ | ↓ | × | ÷ | ± | ≤ | ≥ |
| A | | 。 | 「 | 」 | 、 | ・ | ヲ | ア | イ | ウ | エ | オ | カ | キ | ク | ツ |
| B | ー | ア | イ | ウ | エ | オ | カ | キ | ク | ケ | コ | サ | シ | ス | セ | リ |
| C | タ | チ | ツ | テ | ト | ナ | ニ | ヌ | ネ | ノ | ハ | ヒ | フ | ハ | ホ | マ |
| D | ミ | ム | メ | モ | ヤ | ユ | ヨ | ラ | リ | ル | レ | ロ | ワ | ン | ” | ° |
| E | □ | ■ | ■ | ○ | ● | ◇ | ◆ | ▶ | ◀ | ▲ | ▼ | « | » | ½ | ¼ | |
| F | 日 | 月 | 火 | 水 | 木 | 金 | 土 | 年 | 円 | 分 | 人 | 大 | 中 | 小 | 〒 | |

n=32h

| | 0 | 1 | 2 | 3 | 4 | 5 | 6 | 7 | 8 | 9 | A | B | C | D | E | F |
|---|---|---|---|---|---|---|---|---|---|---|---|---|---|---|---|---|
| 8 | Ç | ü | é | â | ã | à | å | ç | ê | ë | è | ï | î | ì | Ë | Å |
| 9 | É | æ | Æ | ô | ö | ò | û | ù | ÿ | ÿ | Û | ø | £ | Ø | × | f |
| A | á | í | ó | ú | ñ | Ñ | æ | ø | ¿ | ® | ¬ | ½ | ¼ | ¡ | « | » |
| B | ▯ | ▯ | ▯ | | † | Á | Â | À | © | ¶ | | ¶ | ¶ | Φ | ¥ | ∟ |
| C | L | ⊥ | ⊥ | † | - | † | ã | Ã | ℓ | ℓ | ⊥ | π | | = | | ⊗ |
| D | ø | Ð | Ê | Ë | È | ı | í | î | ï | ∟ | ∟ | ■ | ■ | | ì | ■ |
| E | Ó | β | Ô | Ò | Õ | μ | þ | þ | Ú | Û | Û | ý | Ý | ˉ | ´ | |
| F | - | ± | = | ¾ | ¶ | § | ÷ | ˘ | ° | ¨ | . | 1 | 3 | 2 | ■ | |

n=33h

| | 0 | 1 | 2 | 3 | 4 | 5 | 6 | 7 | 8 | 9 | A | B | C | D | E | F |
|---|---|---|---|---|---|---|---|---|---|---|---|---|---|---|---|---|
| 8 | Ç | ü | é | â | ã | à | Á | ç | ê | Ê | è | í | ô | ì | Ë | Å |
| 9 | É | À | È | ô | ö | ò | ú | ù | ì | õ | Û | Φ | £ | Û | ℞ | Ó |
| A | á | í | ó | ú | ñ | Ñ | æ | ø | ¿ | Ò | ¬ | ½ | ¼ | ¡ | « | » |
| B | ▯ | ▯ | ▯ | | † | † | ¶ | ¶ | ¶ | | ¶ | ¶ | ¶ | ¶ | ¶ | ∟ |
| C | L | ⊥ | ⊥ | † | - | † | † | | ℓ | ℓ | ⊥ | π | | = | | ⊥ |
| D | ⊥ | ⊥ | π | ℓ | ℓ | ∟ | ∟ | ¶ | ¶ | ∟ | ∟ | ■ | ■ | ■ | ■ | ■ |
| E | α | β | Γ | π | Σ | σ | μ | τ | Φ | θ | Ω | δ | ∞ | φ | ε | ∩ |
| F | ≡ | ± | ≥ | ≤ | ∫ | ∫ | ÷ | ≈ | ° | . | . | √ | n | 2 | ■ | |

n=34h

| | 0 | 1 | 2 | 3 | 4 | 5 | 6 | 7 | 8 | 9 | A | B | C | D | E | F |
|---|---|---|---|---|---|---|---|---|---|---|---|---|---|---|---|---|
| 8 | Ç | ü | é | â | Â | à | ¶ | ç | ê | ë | è | ï | î | = | À | Š |
| 9 | É | Ê | Ë | ô | Ë | Ī | û | ù | œ | ô | Û | ϕ | £ | Û | Û | f |
| A | ı | ´ | ó | ú | ¨ | ˆ | ³ | ¯ | î | ƒ | ¬ | ½ | ¼ | ¾ | « | » |
| B | ▤ | ▥ | ▦ | | † | ‡ | § | ¶ | ⌈ | ⌋ | ∥ | ⌈ | ⌋ | ⌈ | ⌋ | ⌈ |
| C | ⌊ | ⌋ | ⌌ | ⌍ | ⌎ | ⌏ | ⌐ | ⌑ | ⌒ | ⌓ | ⌔ | ⌕ | ⌖ | ⌗ | ⌘ | ⌙ |
| D | ⌚ | ⌛ | ⌜ | ⌝ | ⌞ | ⌟ | ⌠ | ⌡ | ⌢ | ⌣ | ■ | ■ | ■ | ■ | ■ | ■ |
| E | α | β | Γ | π | Σ | σ | μ | τ | Φ | θ | Ω | δ | ∞ | φ | ε | ∩ |
| F | ≡ | ± | ≥ | ≤ | ∫ | ∫ | ÷ | ≈ | ° | • | • | √ | n | 2 | ■ | |

n=35h

| | 0 | 1 | 2 | 3 | 4 | 5 | 6 | 7 | 8 | 9 | A | B | C | D | E | F |
|---|---|---|---|---|---|---|---|---|---|---|---|---|---|---|---|---|
| 8 | Ç | ü | é | â | ä | à | å | ç | ê | ë | è | ï | î | ì | Ä | Å |
| 9 | É | æ | Æ | ô | ö | ò | û | ù | ÿ | ÿ | Û | ø | £ | Ø | ℞ | f |
| A | á | í | ó | ú | ñ | Ñ | æ | œ | ¿ | ƒ | ¬ | ½ | ¼ | ı | « | œ |
| B | ▤ | ▥ | ▦ | | † | ‡ | § | ¶ | ⌈ | ⌋ | ∥ | ⌈ | ⌋ | ⌈ | ⌋ | ⌈ |
| C | ⌊ | ⌋ | ⌌ | ⌍ | ⌎ | ⌏ | ⌐ | ⌑ | ⌒ | ⌓ | ⌔ | ⌕ | ⌖ | ⌗ | ⌘ | ⌙ |
| D | ⌚ | ⌛ | ⌜ | ⌝ | ⌞ | ⌟ | ⌠ | ⌡ | ⌢ | ⌣ | ■ | ■ | ■ | ■ | ■ | ■ |
| E | α | β | Γ | π | Σ | σ | μ | τ | Φ | θ | Ω | δ | ∞ | φ | ε | ∩ |
| F | ≡ | ± | ≥ | ≤ | ∫ | ∫ | ÷ | ≈ | ° | • | • | √ | n | 2 | ■ | |

n=36h

| | 0 | 1 | 2 | 3 | 4 | 5 | 6 | 7 | 8 | 9 | A | B | C | D | E | F |
|---|---|---|---|---|---|---|---|---|---|---|---|---|---|---|---|---|
| 8 | € | , | f | „ | … | † | ‡ | ^ | % | Š | < | Œ | | Ž | | |
| 9 | | ‘ | ’ | “ | ” | • | - | - | ~ | ™ | Š | > | œ | | ž | ÿ |
| A | | ı | ϕ | ℓ | α | ¥ | ı | § | ¨ | © | ® | « | ¬ | - | ® | ¯ |
| B | ° | ± | ² | ³ | ´ | µ | ¶ | · | ¸ | ¹ | º | » | ¼ | ½ | ¾ | ¿ |
| C | À | Á | Â | Ã | Ä | Å | Æ | Ç | È | É | Ê | Ë | Ì | Í | Î | Ï |
| D | Ð | Ñ | Ò | Ó | Ô | Õ | Ö | × | Ø | Ù | Ú | Û | Ü | Ý | Þ | ß |
| E | à | á | â | ã | ä | å | æ | ç | è | é | ê | ë | ì | í | î | ï |
| F | ð | ñ | ò | ó | ô | õ | ö | ÷ | ø | ù | ú | û | ü | ý | þ | ÿ |

n=37h

| | 0 | 1 | 2 | 3 | 4 | 5 | 6 | 7 | 8 | 9 | A | B | C | D | E | F |
|---|---|---|---|---|---|---|---|---|---|---|---|---|---|---|---|---|
| 8 | А | Б | В | Г | Д | Е | Ж | З | И | Й | К | Л | М | Н | О | П |
| 9 | Р | С | Т | У | Ф | Х | Ц | Ч | Ш | Щ | Ъ | Ы | Ь | Э | Ю | Я |
| A | а | б | в | г | д | е | ж | з | и | й | к | л | м | н | о | п |
| B | ⋮ | ⋮ | ⋮ | | ┌ | ┐ | └ | ┘ | ┌ | ┐ | └ | ┘ | ┌ | ┐ | └ | ┘ |
| C | ┌ | └ | ┐ | ┘ | ┌ | └ | ┐ | ┘ | ┌ | └ | ┐ | ┘ | ┌ | └ | ┐ | ┘ |
| D | ┌ | └ | ┐ | ┘ | ┌ | └ | ┐ | ┘ | ┌ | └ | ┐ | ┘ | ┌ | └ | ┐ | ┘ |
| E | р | с | т | у | ф | х | ц | ч | ш | щ | ъ | ы | ь | э | ю | я |
| F | ē | ĕ | ĉ | e | ī | ĭ | ÿ | ÿ | ° | · | · | √ | № | α | ■ | |

n=38h

| | 0 | 1 | 2 | 3 | 4 | 5 | 6 | 7 | 8 | 9 | A | B | C | D | E | F |
|---|---|---|---|---|---|---|---|---|---|---|---|---|---|---|---|---|
| 8 | Ç | ü | é | â | ã | û | ó | ç | ł | ë | ö | ó | î | ž | Ā | Ć |
| 9 | É | Ĺ | í | ô | ö | Ľ | ĺ | š | ś | ö | ü | ř | ť | ł | × | č |
| A | á | í | ó | ú | Ą | ą | Ż | ż | Ę | ę | ¬ | ż | Č | š | « | » |
| B | ▯ | ▯ | ▯ | | † | Á | Â | Ě | Š | ‡ | ‖ | ⌈ | ⌋ | Ž | ž | ⌋ |
| C | Ł | ł | τ | † | - | † | Ǻ | ǻ | Ł | ł | ⌋ | ⌈ | ‡ | = | ‡ | ⊘ |
| D | đ | Đ | Ď | Ě | ď | Ň | í | î | ě | ⌋ | ł | ▯ | ▯ | Ť | Ů | ▯ |
| E | Ó | β | Ô | Ň | ň | ň | š | ś | Ř | Ú | ř | Ů | ý | Ý | ť | ´ |
| F | - | ˘ | ˙ | ˘ | ˘ | š | ÷ | ˙ | ° | ˘ | ˙ | ú | ř | ř | ▯ | |

n=39h

| | 0 | 1 | 2 | 3 | 4 | 5 | 6 | 7 | 8 | 9 | A | B | C | D | E | F |
|---|---|---|---|---|---|---|---|---|---|---|---|---|---|---|---|---|
| 8 | Ç | ü | é | â | ã | à | â | ç | ê | ë | è | ī | î | ì | Ā | Ă |
| 9 | É | æ | Æ | ô | ö | ò | û | ù | ÿ | ö | ü | ø | ƒ | Ø | × | f |
| A | á | í | ó | ú | ñ | Ñ | æ | ø | ç | ⊘ | ¬ | ½ | ¼ | i | « | » |
| B | ▯ | ▯ | ▯ | | † | Á | Â | À | © | ‡ | ‖ | ⌈ | ⌋ | φ | ¥ | ⌋ |
| C | Ł | ł | τ | † | - | † | Ǻ | ǻ | Ł | ł | ⌋ | ⌈ | ‡ | = | ‡ | ⊘ |
| D | ø | Đ | Ê | Ě | È | € | í | î | ī | ⌋ | ł | ▯ | ▯ | ! | î | ▯ |
| E | Ó | β | Ô | Ò | Õ | Ǿ | μ | þ | þ | Ú | Ů | Ů | ý | Ý | ˉ | ´ |
| F | - | ± | = | ¾ | ¶ | š | ÷ | ˙ | ° | ˘ | ˙ | 1 | 3 | 2 | ▯ | |

16x16dot font

n = 3Ah Japanese font(shift JIS)

Japanese font (shift JIS)

*The displayed characters are Ming type.

| | | | | | | | | | | | | | | | | | | | | | | | | | | | | | | | | | | | | | | |
|------|----|--------------|----|-----|----|----|----|----|----|----|----|----|----|----|----|----|-----|-----|-----|-----|-----|-----|-----|-----|-----|-----|-----|------|-----|-----|-----|-----|---|---|---|---|---|--|
| | +0 | +1 | +2 | +3 | +4 | +5 | +6 | +7 | +8 | +9 | +A | +B | +C | +D | +E | +F | +10 | +11 | +12 | +13 | +14 | +15 | +16 | +17 | +18 | +19 | +1A | +1B | +1C | +1D | +1E | +1F | | | | | | |
| A0 | □ | □ | □ | □ | □ | □ | □ | □ | □ | □ | □ | □ | □ | □ | □ | □ | □ | □ | □ | □ | □ | □ | □ | □ | □ | □ | □ | □ | □ | □ | □ | □ | □ | | | | | |
| C0 | ㊦ | ㊧ | ㊨ | ㊩ | ㊪ | ㊫ | ㊬ | ㊭ | ㊮ | ㊯ | ㊰ | ㊱ | ㊲ | ㊳ | ㊴ | ㊵ | ㊶ | ㊷ | ㊸ | ㊹ | ㊺ | ㊻ | ㊼ | ㊽ | ㊾ | ㊿ | ㊿ | ㊿ | ㊿ | ㊿ | ㊿ | ㊿ | ㊿ | | | | | |
| 8140 | □ | □ | □ | □ | □ | □ | □ | □ | □ | □ | □ | □ | □ | □ | □ | □ | □ | □ | □ | □ | □ | □ | □ | □ | □ | □ | □ | □ | □ | □ | □ | □ | □ | | | | | |
| 8160 | ~ | | | ... | .. | ' | “ | ” | (|) | [|] | { | } | < | > | 《 | 》 | ┌ | ┐ | └ | ┘ | ├ | ┤ | ├ | ┤ | + | - | ± | × | | | | | | | | |
| 8180 | ÷ | = | ≠ | < | > | ≤ | ≥ | ∞ | ∴ | ♂ | ♀ | ° | ′ | ″ | ℃ | ¥ | \$ | ¢ | £ | % | # | & | * | @ | § | ☆ | ★ | ○ | ● | ◎ | ◇ | ◆ | | | | | | |
| 81A0 | □ | ■ | △ | ▲ | ▽ | ▼ | ※ | 〒 | → | ← | ↑ | ↓ | ≡ | | | | | | | | | | | | | ≡ | ≡ | ≡ | ≡ | ≡ | ≡ | ≡ | ≡ | | | | | |
| 81C0 | | | | | | | | | | | | | | | | | | | | | | | | | | | | | | | | | | | | | | |
| 81E0 | ≡ | ≡ | ≡ | ≡ | ≡ | ≡ | ≡ | ≡ | ≡ | ≡ | ≡ | ≡ | ≡ | ≡ | ≡ | ≡ | ≡ | ≡ | ≡ | ≡ | ≡ | ≡ | ≡ | ≡ | ≡ | ≡ | ≡ | ≡ | ≡ | ≡ | ≡ | ≡ | ≡ | | | | | |
| 8240 | | | | | | | | | | | | | | | | | | | | | | | | | | | | | | | | | | | | | | |
| 8260 | A | B | C | D | E | F | G | H | I | J | K | L | M | N | O | P | Q | R | S | T | U | V | W | X | Y | Z | | | | | | | | | | | | |
| 8280 | a | b | c | d | e | f | g | h | i | j | k | l | m | n | o | p | q | r | s | t | u | v | w | x | y | z | | | | | | | | | あ | | | |
| 82A0 | あ | い | う | え | お | か | が | き | ぎ | く | ぐ | け | げ | こ | ご | さ | ざ | し | じ | ず | ぜ | そ | ぞ | た | だ | ち | | | | | | | | | | | | |
| 82C0 | ぢ | っ | つ | づ | て | で | と | ど | な | に | ぬ | ね | の | は | ば | ひ | び | ぶ | ぶ | ぶ | へ | へ | へ | ほ | ぼ | ぼ | ま | み | む | め | | | | | | | | |
| 82E0 | も | や | や | ゆ | ゆ | よ | よ | ら | り | る | ね | ろ | わ | わ | ぬ | ゑ | を | ん | | | | | | | | | | | | | | | | | | | | |
| 8340 | ア | イ | ウ | エ | オ | カ | キ | ク | ケ | コ | サ | ザ | シ | ジ | ス | ズ | セ | ゼ | ソ | ゾ | タ | ダ | | | | | | | | | | | | | | | | |
| 8360 | チ | ツ | テ | ト | ナ | ニ | ネ | ノ | ハ | バ | パ | ヒ | ビ | ブ | フ | フ | ヘ | ベ | ホ | ボ | マ | ミ | | | | | | | | | | | | | | | | |
| 8380 | △ | × | モ | ヤ | ユ | ヨ | ラ | リ | ル | レ | ロ | ワ | ヰ | ヱ | ン | ヴ | カ | ケ | | | | | | | | | | | | | | | | | | A | | |
| 83A0 | B | Γ | Δ | E | Z | H | Θ | I | K | Λ | M | N | Ξ | O | Π | Ρ | Σ | T | Υ | Φ | X | Ψ | Ω | | | | | | | | | | | | | α | | |
| 83C0 | β | γ | δ | ε | ζ | η | θ | ι | κ | λ | μ | ν | ξ | ο | π | ρ | σ | τ | υ | φ | χ | ψ | ω | | | | | | | | | | | | | | | |
| 83E0 | | | | | | | | | | | | | | | | | | | | | | | | | | | | | | | | | | | | | | |
| 8440 | А | Б | В | Г | Д | Е | Ё | Ж | З | И | Й | К | Л | М | Н | О | П | Р | С | Т | У | Ф | Х | Ц | Ч | Ш | Щ | Ъ | Ы | Ь | Э | Ю | | | | | | |
| 8460 | Я | | | | | | | | | | | | | | | | | | | | | | | | | | | | | | | | | | | | | |
| 8480 | о | п | р | с | т | у | ф | х | ц | ч | ш | щ | ъ | ы | ь | э | ю | я | | | | | | | | | | | | | | | | | | | | |
| 84A0 | П | Г | Г | Г | Г | Г | Г | Г | Г | Г | Г | Г | Г | Г | Г | Г | Г | Г | Г | Г | Г | Г | Г | Г | Г | Г | Г | Г | Г | Г | Г | Г | Г | Г | Г | Г | | |
| 84C0 | | | | | | | | | | | | | | | | | | | | | | | | | | | | | | | | | | | | | | |
| 84E0 | | | | | | | | | | | | | | | | | | | | | | | | | | | | | | | | | | | | | | |
| 8540 | ! | ” | # | \$ | % | & | ' | (|) | * | + | , | - | . | / | 0 | 1 | 2 | 3 | 4 | 5 | 6 | 7 | 8 | 9 | : | ; | < | = | > | ? | @ | | | | | | |
| 8560 | A | B | C | D | E | F | G | H | I | J | K | L | M | N | O | P | Q | R | S | T | U | V | W | X | Y | Z | [| ¥ |] | ^ | _ | | | | | | | |
| 8580 | ~ | a | b | c | d | e | f | g | h | i | j | k | l | m | n | o | p | q | r | s | t | u | v | w | x | y | z | { | | } | □ | 。 | | | | | | |
| 85A0 | ┌ | ┐ | ┌ | ┐ | ┌ | ┐ | ┌ | ┐ | ┌ | ┐ | ┌ | ┐ | ┌ | ┐ | ┌ | ┐ | ┌ | ┐ | ┌ | ┐ | ┌ | ┐ | ┌ | ┐ | ┌ | ┐ | ┌ | ┐ | ┌ | ┐ | ┌ | ┐ | ┌ | ┐ | ┌ | ┐ | | |
| 85C0 | ㊦ | ㊧ | ㊨ | ㊩ | ㊪ | ㊫ | ㊬ | ㊭ | ㊮ | ㊯ | ㊰ | ㊱ | ㊲ | ㊳ | ㊴ | ㊵ | ㊶ | ㊷ | ㊸ | ㊹ | ㊺ | ㊻ | ㊼ | ㊽ | ㊾ | ㊿ | ㊿ | ㊿ | ㊿ | ㊿ | ㊿ | ㊿ | ㊿ | ㊿ | ㊿ | ㊿ | | |
| 85E0 | | | | | | | | | | | | | | | | | | | | | | | | | | | | | | | | | | | | | | |
| 8640 | | | | | | | | | | | | | | | | | | | | | | | | | | | | | | | | | | | | | | |
| 8660 | | | | | | | | | | | | | | | | | | | | | | | | | | | | | | | | | | | | | | |
| 8680 | | | | | | | | | | | | | | | | | | | | | | | | | | | | | | | | | | | | | | |
| 86A0 | | | | | | | | | | | | | | | | | | | | | | | | | | | | | | | | | | | | | | |
| 86C0 | | | | | | | | | | | | | | | | | | | | | | | | | | | | | | | | | | | | | | |
| 86E0 | | | | | | | | | | | | | | | | | | | | | | | | | | | | | | | | | | | | | | |
| 8740 | ① | ② | ③ | ④ | ⑤ | ⑥ | ⑦ | ⑧ | ⑨ | ⑩ | ⑪ | ⑫ | ⑬ | ⑭ | ⑮ | ⑯ | ⑰ | ⑱ | ⑲ | ⑳ | I | II | III | IV | V | VI | VII | VIII | IX | X | | | | | | ㊿ | | |
| 8760 | キ | ク | ク | ク | ク | ク | ク | ク | ク | ク | ク | ク | ク | ク | ク | ク | ク | ク | ク | ク | ク | ク | ク | ク | ク | ク | ク | ク | ク | ク | ク | ク | ク | ク | ク | ク | ク | |
| 8780 | “ | 。 No. KK TEL | Ⓢ | Ⓢ | Ⓢ | Ⓢ | Ⓢ | Ⓢ | Ⓢ | Ⓢ | Ⓢ | Ⓢ | Ⓢ | Ⓢ | Ⓢ | Ⓢ | Ⓢ | Ⓢ | Ⓢ | Ⓢ | Ⓢ | Ⓢ | Ⓢ | Ⓢ | Ⓢ | Ⓢ | Ⓢ | Ⓢ | Ⓢ | Ⓢ | Ⓢ | Ⓢ | Ⓢ | Ⓢ | Ⓢ | | | |
| 87A0 | | | | | | | | | | | | | | | | | | | | | | | | | | | | | | | | | | | | | | |
| 87C0 | | | | | | | | | | | | | | | | | | | | | | | | | | | | | | | | | | | | | | |
| 87E0 | | | | | | | | | | | | | | | | | | | | | | | | | | | | | | | | | | | | | | |
| 8840 | | | | | | | | | | | | | | | | | | | | | | | | | | | | | | | | | | | | | | |
| 8860 | | | | | | | | | | | | | | | | | | | | | | | | | | | | | | | | | | | | | | |
| 8880 | | | | | | | | | | | | | | | | | | | | | | | | | | | | | | | | | | | | | | |
| 88A0 | 啞 | 娃 | 阿 | 哀 | 愛 | 挨 | 始 | 逢 | 葵 | 茜 | 穉 | 惡 | 握 | 渥 | 旭 | 葦 | 鱗 | 梓 | 庄 | 幹 | 扱 | 宛 | 姐 | 虻 | 飴 | 絢 | 綾 | 鮎 | 或 | 粟 | 裕 | | | | | | | |
| 88C0 | 安 | 庵 | 按 | 暗 | 案 | 闇 | 鞍 | 杏 | 以 | 伊 | 位 | 依 | 偉 | 困 | 夷 | 委 | 威 | 尉 | 惟 | 意 | 慰 | 易 | 椅 | 為 | 畏 | 異 | 移 | 維 | 緯 | 胃 | 萎 | 衣 | | | | | | |
| 88E0 | 謂 | 違 | 遺 | 医 | 井 | 亥 | 域 | 育 | 郁 | 磯 | 一 | 壹 | 溢 | 逸 | 稻 | 茨 | 芋 | 鱒 | 允 | 印 | 咽 | 員 | 因 | 姻 | 引 | 飲 | 淫 | 胤 | 蔭 | | | | | | | | | |

| | +0 | +1 | +2 | +3 | +4 | +5 | +6 | +7 | +8 | +9 | +A | +B | +C | +D | +E | +F | +10 | +11 | +12 | +13 | +14 | +15 | +16 | +17 | +18 | +19 | +1A | +1B | +1C | +1D | +1E | +1F | |
|------|----|----|----|----|----|----|----|----|----|----|----|----|----|----|----|----|-----|-----|-----|-----|-----|-----|-----|-----|-----|-----|-----|-----|-----|-----|-----|-----|---|
| E940 | 顛 | 顛 | 顛 | 廡 | 廡 | 廡 | 廡 | 廡 | 廡 | 廡 | 廡 | 廡 | 廡 | 廡 | 廡 | 廡 | 廡 | 廡 | 廡 | 廡 | 廡 | 廡 | 廡 | 廡 | 廡 | 廡 | 廡 | 廡 | 廡 | 廡 | 廡 | 廡 | |
| E960 | 饒 | 饒 | 饒 | 道 | 馥 | 馥 | 馥 | 馥 | 馥 | 馥 | 馥 | 馥 | 馥 | 馥 | 馥 | 馥 | 馥 | 馥 | 馥 | 馥 | 馥 | 馥 | 馥 | 馥 | 馥 | 馥 | 馥 | 馥 | 馥 | 馥 | 馥 | 馥 | |
| E980 | 鬃 | 鬃 | 鬃 | 鬃 | 鬃 | 鬃 | 鬃 | 鬃 | 鬃 | 鬃 | 鬃 | 鬃 | 鬃 | 鬃 | 鬃 | 鬃 | 鬃 | 鬃 | 鬃 | 鬃 | 鬃 | 鬃 | 鬃 | 鬃 | 鬃 | 鬃 | 鬃 | 鬃 | 鬃 | 鬃 | 鬃 | 鬃 | |
| E9A0 | 鬃 | 鬃 | 鬃 | 鬃 | 鬃 | 鬃 | 鬃 | 鬃 | 鬃 | 鬃 | 鬃 | 鬃 | 鬃 | 鬃 | 鬃 | 鬃 | 鬃 | 鬃 | 鬃 | 鬃 | 鬃 | 鬃 | 鬃 | 鬃 | 鬃 | 鬃 | 鬃 | 鬃 | 鬃 | 鬃 | 鬃 | 鬃 | |
| E9C0 | 鯊 | 鯊 | 鯊 | 鯊 | 鯊 | 鯊 | 鯊 | 鯊 | 鯊 | 鯊 | 鯊 | 鯊 | 鯊 | 鯊 | 鯊 | 鯊 | 鯊 | 鯊 | 鯊 | 鯊 | 鯊 | 鯊 | 鯊 | 鯊 | 鯊 | 鯊 | 鯊 | 鯊 | 鯊 | 鯊 | 鯊 | 鯊 | |
| E9E0 | 鰲 | 鰲 | 鰲 | 鰲 | 鰲 | 鰲 | 鰲 | 鰲 | 鰲 | 鰲 | 鰲 | 鰲 | 鰲 | 鰲 | 鰲 | 鰲 | 鰲 | 鰲 | 鰲 | 鰲 | 鰲 | 鰲 | 鰲 | 鰲 | 鰲 | 鰲 | 鰲 | 鰲 | 鰲 | 鰲 | 鰲 | 鰲 | |
| EA40 | 鵝 | 鵝 | 鵝 | 鵝 | 鵝 | 鵝 | 鵝 | 鵝 | 鵝 | 鵝 | 鵝 | 鵝 | 鵝 | 鵝 | 鵝 | 鵝 | 鵝 | 鵝 | 鵝 | 鵝 | 鵝 | 鵝 | 鵝 | 鵝 | 鵝 | 鵝 | 鵝 | 鵝 | 鵝 | 鵝 | 鵝 | | |
| EA60 | 鵝 | 鵝 | 鵝 | 鵝 | 鵝 | 鵝 | 鵝 | 鵝 | 鵝 | 鵝 | 鵝 | 鵝 | 鵝 | 鵝 | 鵝 | 鵝 | 鵝 | 鵝 | 鵝 | 鵝 | 鵝 | 鵝 | 鵝 | 鵝 | 鵝 | 鵝 | 鵝 | 鵝 | 鵝 | 鵝 | 鵝 | | |
| EA80 | 徽 | 徽 | 徽 | 徽 | 徽 | 徽 | 徽 | 徽 | 徽 | 徽 | 徽 | 徽 | 徽 | 徽 | 徽 | 徽 | 徽 | 徽 | 徽 | 徽 | 徽 | 徽 | 徽 | 徽 | 徽 | 徽 | 徽 | 徽 | 徽 | 徽 | 徽 | 徽 | 徽 |
| EAA0 | 楨 | 達 | 瑤 | 涼 | 熙 | | | | | | | | | | | | | | | | | | | | | | | | | | | | |

n = 3Bh Simplified Chinese(GB2312)

| | +0 | +1 | +2 | +3 | +4 | +5 | +6 | +7 | +8 | +9 | +A | +B | +C | +D | +E | +F | +10 | +11 | +12 | +13 | +14 | +15 | +16 | +17 | +18 | +19 | +1A | +1B | +1C | +1D | +1E | +1F | |
|------|-----|-----|-----|-----|-----|----|----|----|----|----|----|----|----|----|----|----|-----|-----|-----|-----|-----|-----|-----|-----|------|-----|-----|-----|-----|-----|-----|-----|--|
| A1A0 | □ | □ | □ | □ | □ | □ | □ | □ | □ | □ | □ | □ | □ | □ | □ | □ | □ | □ | □ | □ | □ | □ | □ | □ | □ | □ | □ | □ | □ | □ | □ | □ | |
| A1C0 | ± | × | ÷ | ∴ | ∧ | ∨ | ∑ | ∏ | ∪ | ∩ | € | ∴ | ✓ | ⊥ | # | ∠ | ∩ | ⊙ | ∫ | ∫ | ≡ | ≈ | ≈ | ∞ | ≠ | ← | → | ≤ | ≥ | ∞ | ∴ | | |
| A1E0 | ∴ | ♂ | ♀ | ° | ′ | ″ | ℃ | \$ | ⊗ | ⊕ | £ | % | § | No | ☆ | ★ | ○ | ● | ◎ | ◇ | ◆ | □ | ■ | △ | ▲ | ※ | → | ← | ↑ | ↓ | ≡ | | |
| A2A0 | | | | | | | | | | | | | | | | | | 1. | 2. | 3. | 4. | 5. | 6. | 7. | 8. | 9. | 10. | 11. | 12. | 13. | 14. | 15. | |
| A2C0 | 16. | 17. | 18. | 19. | 20. | ① | ② | ③ | ④ | ⑤ | ⑥ | ⑦ | ⑧ | ⑨ | ⑩ | ⑪ | ⑫ | ⑬ | ⑭ | ⑮ | ⑯ | ⑰ | ⑱ | ⑲ | ⑳ | ㉑ | ㉒ | ㉓ | ㉔ | ㉕ | ㉖ | ㉗ | |
| A2E0 | ㉘ | ㉙ | ㉚ | | ㊶ | ㊷ | ㊸ | ㊹ | ㊺ | ㊻ | ㊼ | ㊽ | ㊾ | ㊿ | | | | I | II | III | IV | V | VI | VII | VIII | IX | X | XI | XII | | | | |
| A3A0 | ! | " | # | ¥ | % | & | ' | (|) | * | + | , | - | . | / | 0 | 1 | 2 | 3 | 4 | 5 | 6 | 7 | 8 | 9 | : | ; | < | = | > | ? | | |
| A3C0 | @ | A | B | C | D | E | F | G | H | I | J | K | L | M | N | O | P | Q | R | S | T | U | V | W | X | Y | Z | [| \ |] | ^ | _ | |
| A3E0 | ` | a | b | c | d | e | f | g | h | i | j | k | l | m | n | o | p | q | r | s | t | u | v | w | x | y | z | { | | } | □ | | |
| A4A0 | あ | い | う | え | お | か | が | き | ぎ | く | け | こ | さ | ざ | し | じ | ず | ぜ | そ | ぞ | た | | | | | | | | | | | | |
| A4C0 | だ | ち | っ | つ | て | と | ど | な | に | ぬ | ね | の | は | ば | び | び | び | ふ | ぶ | ぶ | へ | べ | べ | ほ | ぼ | ま | み | | | | | | |
| A4E0 | む | め | も | や | ゆ | よ | ら | り | る | ろ | わ | わ | ゑ | を | ん | | | | | | | | | | | | | | | | | | |
| A5A0 | ア | イ | ウ | エ | オ | カ | キ | ク | ケ | コ | サ | シ | ス | セ | ソ | タ | | | | | | | | | | | | | | | | | |
| A5C0 | チ | ツ | テ | ト | ナ | ニ | ノ | ハ | パ | ヒ | フ | ブ | ヘ | ベ | ホ | マ | | | | | | | | | | | | | | | | | |
| A5E0 | ム | メ | モ | ヤ | ユ | ヨ | ラ | リ | ル | ロ | ワ | ヰ | ヱ | ヲ | ヾ | カ | | | | | | | | | | | | | | | | | |
| A6A0 | A | B | Γ | Δ | E | Z | H | Θ | I | K | Λ | M | N | Ξ | O | Π | P | Σ | T | Τ | Φ | X | Ψ | Ω | | | | | | | | | |
| A6C0 | α | β | γ | δ | ε | ζ | η | θ | ι | κ | λ | μ | ν | ξ | ο | π | ρ | σ | τ | υ | φ | χ | ψ | ω | | | | | | | | | |
| A6E0 | | | | | | | | | | | | | | | | | | | | | | | | | | | | | | | | | |
| A7A0 | А | В | Г | Д | Е | Ё | Ж | З | И | Й | К | Л | М | Н | О | П | Р | С | Т | У | Ф | Х | Ц | Ч | Ш | Щ | Ъ | Ы | Ь | Э | | | |
| A7C0 | Ю | Я | | | | | | | | | | | | | | | | | | | | | | | | | | | | | | | |
| A7E0 | О | П | Р | С | Т | У | Ф | Х | Ц | Ч | Ш | Щ | Ъ | Ы | Ь | Э | Ю | Я | | | | | | | | | | | | | | | |
| A8A0 | ā | á | ǎ | à | ē | é | ě | è | í | í | ǐ | ì | ō | ó | ǒ | ò | ū | ú | ǔ | ù | ū | ú | ǘ | ù | ü | ê | | | | | | | |
| A8C0 | | | | | | | | | | | | | | | | | | | | | | | | | | | | | | | | | |
| A8E0 | ㄨ | ㄨ | ㄨ | ㄨ | ㄨ | ㄨ | ㄨ | ㄨ | ㄨ | ㄨ | ㄨ | ㄨ | ㄨ | ㄨ | ㄨ | ㄨ | ㄨ | ㄨ | ㄨ | ㄨ | ㄨ | ㄨ | ㄨ | ㄨ | ㄨ | ㄨ | ㄨ | ㄨ | ㄨ | ㄨ | ㄨ | | |
| A9A0 | | | | | | | | | | | | | | | | | | | | | | | | | | | | | | | | | |
| A9C0 | ㄩ | ㄩ | ㄩ | ㄩ | ㄩ | ㄩ | ㄩ | ㄩ | ㄩ | ㄩ | ㄩ | ㄩ | ㄩ | ㄩ | ㄩ | ㄩ | ㄩ | ㄩ | ㄩ | ㄩ | ㄩ | ㄩ | ㄩ | ㄩ | ㄩ | ㄩ | ㄩ | ㄩ | ㄩ | ㄩ | ㄩ | | |
| A9E0 | ㄩ | ㄩ | ㄩ | ㄩ | ㄩ | ㄩ | ㄩ | ㄩ | ㄩ | ㄩ | ㄩ | ㄩ | ㄩ | ㄩ | ㄩ | ㄩ | ㄩ | ㄩ | ㄩ | ㄩ | ㄩ | ㄩ | ㄩ | ㄩ | ㄩ | ㄩ | ㄩ | ㄩ | ㄩ | ㄩ | ㄩ | | |
| AAA0 | | | | | | | | | | | | | | | | | | | | | | | | | | | | | | | | | |
| AAC0 | | | | | | | | | | | | | | | | | | | | | | | | | | | | | | | | | |
| AAE0 | | | | | | | | | | | | | | | | | | | | | | | | | | | | | | | | | |
| ABA0 | | | | | | | | | | | | | | | | | | | | | | | | | | | | | | | | | |
| ABC0 | | | | | | | | | | | | | | | | | | | | | | | | | | | | | | | | | |
| ABE0 | | | | | | | | | | | | | | | | | | | | | | | | | | | | | | | | | |
| ACA0 | | | | | | | | | | | | | | | | | | | | | | | | | | | | | | | | | |
| ACC0 | | | | | | | | | | | | | | | | | | | | | | | | | | | | | | | | | |
| ACE0 | | | | | | | | | | | | | | | | | | | | | | | | | | | | | | | | | |
| ADA0 | | | | | | | | | | | | | | | | | | | | | | | | | | | | | | | | | |
| ADC0 | | | | | | | | | | | | | | | | | | | | | | | | | | | | | | | | | |
| ADE0 | | | | | | | | | | | | | | | | | | | | | | | | | | | | | | | | | |
| AEA0 | | | | | | | | | | | | | | | | | | | | | | | | | | | | | | | | | |
| AEC0 | | | | | | | | | | | | | | | | | | | | | | | | | | | | | | | | | |
| AEE0 | | | | | | | | | | | | | | | | | | | | | | | | | | | | | | | | | |
| AFA0 | | | | | | | | | | | | | | | | | | | | | | | | | | | | | | | | | |
| AFC0 | | | | | | | | | | | | | | | | | | | | | | | | | | | | | | | | | |
| AFE0 | | | | | | | | | | | | | | | | | | | | | | | | | | | | | | | | | |
| B0A0 | 啊 | 阿 | 埃 | 挨 | 哎 | 唉 | 哀 | 皑 | 癌 | 蔼 | 矮 | 艾 | 碍 | 爱 | 隘 | 鞅 | 氨 | 安 | 俺 | 按 | 暗 | 岸 | 腋 | 案 | 肮 | 昂 | 盎 | 凹 | 敖 | 熬 | 翱 | | |
| B0C0 | 袄 | 傲 | 奥 | 懊 | 澳 | 芭 | 捌 | 扒 | 叭 | 吧 | 芭 | 八 | 疤 | 巴 | 拔 | 跋 | 靶 | 把 | 耙 | 坝 | 霸 | 罢 | 爸 | 白 | 柏 | 百 | 摆 | 佰 | 败 | 拜 | 裨 | 斑 | |
| B0E0 | 班 | 搬 | 扳 | 般 | 颁 | 扳 | 版 | 扮 | 拌 | 伴 | 瓣 | 半 | 办 | 絆 | 邦 | 帮 | 梆 | 榜 | 膀 | 绑 | 棒 | 磅 | 蚌 | 镑 | 傍 | 滂 | 苞 | 胞 | 包 | 褒 | 剥 | | |

n =3Ch Traditional Chinese(Big5)

| | +0 | +1 | +2 | +3 | +4 | +5 | +6 | +7 | +8 | +9 | +A | +B | +C | +D | +E | +F | +10 | +11 | +12 | +13 | +14 | +15 | +16 | +17 | +18 | +19 | +1A | +1B | +1C | +1D | +1E | +1F | | |
|------|----|----|----|----|----|----|----|----|----|-----|----|----|----|----|----|----|-----|-----|-----|-----|-----|-----|-----|-----|-----|-----|-----|-----|-----|-----|-----|-----|---|---|
| A140 | □ | ◊ | ◊ | ◊ | ◊ | ◊ | ◊ | ◊ | ◊ | ◊ | ◊ | ◊ | ◊ | ◊ | ◊ | ◊ | ◊ | ◊ | ◊ | ◊ | ◊ | ◊ | ◊ | ◊ | ◊ | ◊ | ◊ | ◊ | ◊ | ◊ | ◊ | ◊ | | |
| A160 | ⌈ | ⌋ | ⌈ | ⌋ | ⌈ | ⌋ | ⌈ | ⌋ | ⌈ | ⌋ | ⌈ | ⌋ | ⌈ | ⌋ | ⌈ | ⌋ | ⌈ | ⌋ | ⌈ | ⌋ | ⌈ | ⌋ | ⌈ | ⌋ | ⌈ | ⌋ | ⌈ | ⌋ | ⌈ | ⌋ | ⌈ | ⌋ | | |
| A1A0 | { | } | { | } | { | } | { | } | { | } | { | } | { | } | { | } | { | } | { | } | { | } | { | } | { | } | { | } | { | } | { | } | { | } |
| A1C0 | ⊕ | ⊖ | ⊕ | ⊖ | ⊕ | ⊖ | ⊕ | ⊖ | ⊕ | ⊖ | ⊕ | ⊖ | ⊕ | ⊖ | ⊕ | ⊖ | ⊕ | ⊖ | ⊕ | ⊖ | ⊕ | ⊖ | ⊕ | ⊖ | ⊕ | ⊖ | ⊕ | ⊖ | ⊕ | ⊖ | ⊕ | ⊖ | | |
| A1E0 | < | > | = | ~ | ∩ | ∪ | ∠ | ∟ | ∠ | log | ln | ∫ | ∫ | ∫ | ∫ | ∫ | ∫ | ∫ | ∫ | ∫ | ∫ | ∫ | ∫ | ∫ | ∫ | ∫ | ∫ | ∫ | ∫ | ∫ | ∫ | ∫ | | |
| A240 | ∕ | ∕ | ∕ | \$ | ¥ | ₹ | ₹ | ₹ | ₹ | @ | ° | ° | ° | ° | ° | ° | ° | mil | mm | cm | km | MM | m | mg | kg | cc | ° | 尅 | 尅 | 尅 | 尅 | 尅 | 尅 | |
| A260 | 尅 | 尅 | 尅 | 尅 | 尅 | 尅 | 尅 | 尅 | 尅 | 尅 | 尅 | 尅 | 尅 | 尅 | 尅 | 尅 | 尅 | 尅 | 尅 | 尅 | 尅 | 尅 | 尅 | 尅 | 尅 | 尅 | 尅 | 尅 | 尅 | 尅 | 尅 | 尅 | | |
| A2A0 | ㄅ | ㄆ | ㄇ | ㄏ | ㄏ | ㄏ | ㄏ | ㄏ | ㄏ | ㄏ | ㄏ | ㄏ | ㄏ | ㄏ | ㄏ | ㄏ | ㄏ | ㄏ | ㄏ | ㄏ | ㄏ | ㄏ | ㄏ | ㄏ | ㄏ | ㄏ | ㄏ | ㄏ | ㄏ | ㄏ | ㄏ | | | |
| A2C0 | Ⅷ | Ⅷ | X | Ⅰ | Ⅱ | Ⅲ | Ⅳ | Ⅴ | Ⅵ | Ⅶ | Ⅷ | Ⅷ | Ⅷ | Ⅷ | Ⅷ | Ⅷ | A | B | C | D | E | F | G | H | I | J | K | L | M | N | O | P | Q | |
| A2E0 | R | S | T | U | V | W | X | Y | Z | a | b | c | d | e | f | g | h | i | j | k | l | m | n | o | p | q | r | s | t | u | v | w | | |
| A340 | w | x | y | z | A | B | Γ | Δ | E | Z | H | Θ | I | K | Λ | M | N | Ξ | O | Π | P | Σ | T | Υ | Φ | X | Ψ | Ω | α | β | γ | δ | | |
| A360 | ε | ζ | η | θ | ι | κ | λ | μ | ν | ξ | ο | π | ρ | σ | τ | υ | φ | χ | ψ | ω | ς | ς | ς | ς | ς | ς | ς | ς | ς | ς | ς | ς | | |
| A3A0 | ㄐ | ㄑ | ㄒ | ㄓ | ㄔ | ㄕ | ㄖ | ㄗ | ㄘ | ㄙ | ㄚ | ㄛ | ㄜ | ㄝ | ㄞ | ㄟ | ㄠ | ㄡ | ㄢ | ㄣ | ㄤ | ㄥ | ㄦ | ㄧ | ㄨ | ㄩ | ㄴ | ㄷ | ㄸ | ㄹ | ㄺ | | | |
| A3C0 | □ | □ | □ | □ | □ | □ | □ | □ | □ | □ | □ | □ | □ | □ | □ | □ | □ | □ | □ | □ | □ | □ | □ | □ | □ | □ | □ | □ | □ | □ | □ | □ | □ | |
| A3E0 | □ | □ | □ | □ | □ | □ | □ | □ | □ | □ | □ | □ | □ | □ | □ | □ | □ | □ | □ | □ | □ | □ | □ | □ | □ | □ | □ | □ | □ | □ | □ | □ | □ | |
| A440 | 一 | 乙 | 丁 | 七 | 乃 | 九 | 了 | 二 | 人 | 儿 | 入 | 八 | 几 | 刀 | 刁 | 力 | 匕 | 十 | 卜 | 又 | 三 | 下 | 丈 | 上 | 丫 | 凡 | 凡 | 久 | 么 | 也 | 乞 | 于 | | |
| A460 | 亡 | 元 | 刃 | 勾 | 千 | 叉 | 口 | 土 | 土 | 夕 | 天 | 女 | 子 | 子 | 子 | 寸 | 小 | 无 | 尸 | 山 | 川 | 工 | 己 | 己 | 己 | 巾 | 干 | 开 | 戈 | 弓 | 才 | 凶 | | |
| A4A0 | 丑 | 丐 | 丕 | 丕 | 丕 | 丕 | 丕 | 丕 | 丕 | 丕 | 丕 | 丕 | 丕 | 丕 | 丕 | 丕 | 丕 | 丕 | 丕 | 丕 | 丕 | 丕 | 丕 | 丕 | 丕 | 丕 | 丕 | 丕 | 丕 | 丕 | 丕 | 丕 | | |
| A4C0 | 分 | 切 | 刈 | 勾 | 勾 | 勿 | 化 | 匹 | 午 | 升 | 卅 | 卞 | 厄 | 友 | 及 | 反 | 壬 | 天 | 夫 | 太 | 天 | 孔 | 少 | 尤 | 尺 | 屯 | 巴 | 幻 | 廿 | 弔 | 引 | 心 | | |
| A4E0 | 戈 | 户 | 手 | 扎 | 支 | 文 | 斗 | 斤 | 方 | 日 | 回 | 月 | 木 | 欠 | 正 | 歹 | 母 | 比 | 毛 | 氏 | 水 | 火 | 爪 | 父 | 爻 | 片 | 牙 | 半 | 犬 | 王 | 丙 | 凶 | | |
| A540 | 世 | 丕 | 且 | 丘 | 主 | 乍 | 乏 | 乎 | 以 | 付 | 仔 | 仕 | 他 | 仗 | 代 | 令 | 仙 | 仞 | 充 | 兄 | 再 | 册 | 冬 | 凹 | 出 | 凸 | 刊 | 加 | 功 | 包 | 匆 | 北 | | |
| A560 | 匹 | 任 | 半 | 弄 | 卡 | 占 | 卯 | 危 | 去 | 可 | 古 | 右 | 召 | 叮 | 叩 | 叨 | 司 | 回 | 叫 | 另 | 只 | 史 | 叱 | 台 | 句 | 吠 | 叨 | 叨 | 四 | 囚 | 外 | 正 | 立 | |
| A5A0 | 央 | 失 | 奴 | 奶 | 孕 | 它 | 尼 | 巨 | 巧 | 左 | 市 | 布 | 平 | 幼 | 弃 | 弘 | 弗 | 必 | 戊 | 打 | 扔 | 扒 | 扌 | 扌 | 扌 | 扌 | 扌 | 扌 | 扌 | 扌 | 扌 | 扌 | | |
| A5C0 | 母 | 民 | 氏 | 永 | 汗 | 汀 | 犯 | 玄 | 玉 | 瓜 | 瓦 | 甘 | 生 | 用 | 甩 | 田 | 由 | 甲 | 申 | 申 | 打 | 疋 | 自 | 皮 | 血 | 目 | 矛 | 矢 | 石 | 禾 | 穴 | 立 | | |
| A5E0 | 丞 | 丢 | 兵 | 兵 | 乱 | 瓦 | 交 | 亦 | 亥 | 仿 | 伙 | 伊 | 伏 | 伍 | 伐 | 休 | 伏 | 伸 | 伴 | 任 | 任 | 仰 | 批 | 份 | 企 | 彼 | 光 | 晃 | 兆 | 先 | 全 | 回 | 团 | |
| A640 | 共 | 再 | 冰 | 列 | 刑 | 划 | 划 | 划 | 划 | 划 | 划 | 划 | 划 | 划 | 划 | 划 | 划 | 划 | 划 | 划 | 划 | 划 | 划 | 划 | 划 | 划 | 划 | 划 | 划 | 划 | 划 | 划 | 划 | 划 |
| A660 | 圳 | 地 | 在 | 圭 | 坊 | 圪 | 圪 | 圪 | 圪 | 圪 | 圪 | 圪 | 圪 | 圪 | 圪 | 圪 | 圪 | 圪 | 圪 | 圪 | 圪 | 圪 | 圪 | 圪 | 圪 | 圪 | 圪 | 圪 | 圪 | 圪 | 圪 | 圪 | 圪 | |
| A6A0 | 式 | 弛 | 忙 | 忖 | 戎 | 戎 | 戎 | 戎 | 戎 | 戎 | 戎 | 戎 | 戎 | 戎 | 戎 | 戎 | 戎 | 戎 | 戎 | 戎 | 戎 | 戎 | 戎 | 戎 | 戎 | 戎 | 戎 | 戎 | 戎 | 戎 | 戎 | 戎 | 戎 | 戎 |
| A6C0 | 池 | 汐 | 汕 | 污 | 汛 | 汛 | 汛 | 汛 | 汛 | 汛 | 汛 | 汛 | 汛 | 汛 | 汛 | 汛 | 汛 | 汛 | 汛 | 汛 | 汛 | 汛 | 汛 | 汛 | 汛 | 汛 | 汛 | 汛 | 汛 | 汛 | 汛 | 汛 | 汛 | |
| A6E0 | 舟 | 良 | 色 | 艾 | 虫 | 血 | 行 | 衣 | 西 | 阡 | 串 | 亨 | 位 | 往 | 冷 | 冷 | 冷 | 冷 | 冷 | 冷 | 冷 | 冷 | 冷 | 冷 | 冷 | 冷 | 冷 | 冷 | 冷 | 冷 | 冷 | 冷 | | |
| A740 | 作 | 你 | 伯 | 低 | 伶 | 余 | 徇 | 徇 | 徇 | 徇 | 徇 | 徇 | 徇 | 徇 | 徇 | 徇 | 徇 | 徇 | 徇 | 徇 | 徇 | 徇 | 徇 | 徇 | 徇 | 徇 | 徇 | 徇 | 徇 | 徇 | 徇 | 徇 | 徇 | |
| A760 | 呖 | 吧 | 呆 | 呢 | 莫 | 呈 | 吕 | 君 | 吩 | 告 | 吹 | 吻 | 吸 | 吮 | 吮 | 吮 | 吮 | 吮 | 吮 | 吮 | 吮 | 吮 | 吮 | 吮 | 吮 | 吮 | 吮 | 吮 | 吮 | 吮 | 吮 | 吮 | 吮 | |
| A7A0 | 均 | 坎 | 坎 | 坐 | 坏 | 圪 | 圪 | 圪 | 圪 | 圪 | 圪 | 圪 | 圪 | 圪 | 圪 | 圪 | 圪 | 圪 | 圪 | 圪 | 圪 | 圪 | 圪 | 圪 | 圪 | 圪 | 圪 | 圪 | 圪 | 圪 | 圪 | 圪 | 圪 | |
| A7C0 | 尾 | 岐 | 岑 | 岔 | 岌 | 巫 | 希 | 序 | 底 | 床 | 廷 | 弄 | 弟 | 形 | 形 | 衍 | 徂 | 忘 | 忌 | 志 | 忍 | 忧 | 快 | 忤 | 忤 | 忤 | 忤 | 忤 | 忤 | 忤 | 忤 | 忤 | 忤 | |
| A7E0 | 挟 | 扭 | 把 | 扼 | 找 | 批 | 扳 | 抒 | 扯 | 折 | 扮 | 投 | 抓 | 抑 | 技 | 改 | 攻 | 攸 | 攸 | 攸 | 攸 | 攸 | 攸 | 攸 | 攸 | 攸 | 攸 | 攸 | 攸 | 攸 | 攸 | 攸 | 攸 | |
| A840 | 杓 | 杓 | 步 | 每 | 求 | 隶 | 沙 | 沁 | 沈 | 沉 | 沅 | 沛 | 汪 | 决 | 沐 | 汰 | 沌 | 泪 | 冲 | 浚 | 汽 | 沃 | 沃 | 沃 | 沃 | 沃 | 沃 | 沃 | 沃 | 沃 | 沃 | 沃 | 沃 | |
| A860 | 灼 | 灾 | 炎 | 牢 | 牡 | 牡 | 狄 | 狂 | 玫 | 甫 | 甫 | 男 | 甸 | 皂 | 盯 | 矣 | 私 | 秀 | 秀 | 秀 | 秀 | 秀 | 秀 | 秀 | 秀 | 秀 | 秀 | 秀 | 秀 | 秀 | 秀 | 秀 | 秀 | |
| A8A0 | 芋 | 苟 | 见 | 角 | 言 | 谷 | 豆 | 豕 | 豕 | 豕 | 豕 | 豕 | 豕 | 豕 | 豕 | 豕 | 豕 | 豕 | 豕 | 豕 | 豕 | 豕 | 豕 | 豕 | 豕 | 豕 | 豕 | 豕 | 豕 | 豕 | 豕 | 豕 | 豕 | |
| A8C0 | 阡 | 阡 | 阡 | 并 | 乖 | 乳 | 事 | 些 | 亚 | 享 | 京 | 祥 | 依 | 待 | 佳 | 使 | 佬 | 供 | 例 | 来 | 侃 | 侃 | 侃 | 侃 | 侃 | 侃 | 侃 | 侃 | 侃 | 侃 | 侃 | 侃 | 侃 | |
| A8E0 | 兒 | 兇 | 兩 | 具 | 其 | 典 | 冽 | 函 | 刻 | 券 | 刷 | 刺 | 到 | 刮 | 制 | 剃 | 劾 | 劾 | 劾 | 劾 | 劾 | 劾 | 劾 | 劾 | 劾 | 劾 | 劾 | 劾 | 劾 | 劾 | 劾 | 劾 | 劾 | |
| A940 | 咖 | 吓 | 咕 | 咀 | 呻 | 呻 | 咄 | 咒 | 咆 | 呼 | 附 | 呱 | 呱 | 呱 | 呱 | 呱 | 呱 | 呱 | 呱 | 呱 | 呱 | 呱 | 呱 | 呱 | 呱 | 呱 | 呱 | 呱 | 呱 | 呱 | 呱 | 呱 | 呱 | |
| A960 | 奈 | 畜 | 奔 | 妾 | 妻 | 妻 | 妹 | 妮 | 姑 | 姆 | 姐 | 姍 | 始 | 姓 | 姊 | 姊 | 姊 | 姊 | 姊 | 姊 | 姊 | 姊 | 姊 | 姊 | 姊 | 姊 | 姊 | 姊 | 姊 | 姊 | 姊 | 姊 | 姊 | |
| A9A0 | 屆 | 岷 | 岡 | 岸 | 岩 | 岫 | 岱 | 岳 | 帝 | 帝 | 帝 | 帝 | 帝 | 帝 | 帝 | 帝 | 帝 | 帝 | 帝 | 帝 | 帝 | 帝 | 帝 | 帝 | 帝 | 帝 | 帝 | 帝 | 帝 | 帝 | 帝 | 帝 | 帝 | |
| A9C0 | 念 | 忿 | 快 | 怔 | 怯 | 忧 | 怖 | 怪 | 怕 | 怡 | 性 | 悒 | 悒 | 悒 | 悒 | 悒 | 悒 | 悒 | 悒 | 悒 | 悒 | 悒 | 悒 | 悒 | 悒 | 悒 | 悒 | 悒 | 悒 | 悒 | 悒 | 悒 | 悒 | |
| A9E0 | 拈 | 揅 | 抽 | 押 | 拐 | 拙 | 拇 | 拍 | 抵 | 拈 | 抱 | 拘 | 拖 | 拗 | 拆 | 抬 | 拎 | 放 | 松 | 析 | 杵 | 杵 | 杵 | 杵 | 杵 | 杵 | 杵 | 杵 | 杵 | 杵 | 杵 | 杵 | 杵 | |
| AA40 | 鼻 | 服 | 朋 | 杭 | 枋 | 枕 | 東 | 果 | 香 | 杷 | 枇 | 枝 | 林 | 杯 | 杰 | 板 | 枉 | 松 | 析 | 杵 | 杵 | 杵 | 杵 | 杵 | 杵 | 杵 | 杵 | 杵 | 杵 | 杵 | 杵 | 杵 | 杵 | |
| AA60 | 注 | 泳 | 沱 | 泌 | 泥 | 河 | 沽 | 沽 | 沼 | 波 | 沫 | 法 | 泓 | 沸 | 泄 | 油 | 况 | 沮 | 泗 | 泗 | 泗 | 泗 | 泗 | 泗 | 泗 | 泗 | 泗 | 泗 | 泗 | 泗 | 泗 | 泗 | 泗 | |
| AAA0 | 炕 | 炎 | 炒 | 炊 | 炙 | 爬 | 爭 | 鬻 | 版 | 牧 | 物 | 狀 | 狎 | 狙 | 狗 | 狐 | 玩 | 玃 | 玃 | 玃 | 玃 | 玃 | 玃 | 玃 | 玃 | 玃 | 玃 | 玃 | 玃 | 玃 | 玃 | 玃 | 玃 | |

| | +0 | +1 | +2 | +3 | +4 | +5 | +6 | +7 | +8 | +9 | +A | +B | +C | +D | +E | +F | +10 | +11 | +12 | +13 | +14 | +15 | +16 | +17 | +18 | +19 | +1A | +1B | +1C | +1D | +1E | +1F | | |
|------|----|----|----|----|----|----|----|----|----|----|----|----|----|----|----|----|-----|-----|-----|-----|-----|-----|-----|-----|-----|-----|-----|-----|-----|-----|-----|-----|---|---|
| B460 | 循 | 徨 | 惑 | 惡 | 悲 | 悶 | 惠 | 愜 | 悵 | 惺 | 愕 | 情 | 惻 | 惴 | 慨 | 惱 | 懷 | 惶 | 愉 | 愀 | 悒 | 戢 | 扉 | 掣 | 掌 | 描 | 揀 | 揩 | 揉 | 揆 | 撲 | 曾 | | |
| B4A0 | | 插 | 揣 | 提 | 握 | 搦 | 搦 | 揮 | 捶 | 援 | 揪 | 換 | 憫 | 惴 | 揚 | 徹 | 敦 | 敦 | 散 | 斑 | 裴 | 斯 | 普 | 擊 | 掌 | 描 | 揀 | 揩 | 揉 | 揆 | 撲 | 曾 | | |
| B4C0 | 替 | 期 | 朝 | 提 | 握 | 搦 | 搦 | 揮 | 捶 | 援 | 揪 | 換 | 憫 | 惴 | 揚 | 徹 | 敦 | 敦 | 散 | 斑 | 裴 | 斯 | 普 | 擊 | 掌 | 描 | 揀 | 揩 | 揉 | 揆 | 撲 | 曾 | | |
| B4E0 | 稔 | 氣 | 氣 | 氣 | 氣 | 氣 | 氣 | 氣 | 氣 | 氣 | 氣 | 氣 | 氣 | 氣 | 氣 | 氣 | 氣 | 氣 | 氣 | 氣 | 氣 | 氣 | 氣 | 氣 | 氣 | 氣 | 氣 | 氣 | 氣 | 氣 | 氣 | 氣 | 氣 | |
| B540 | 溉 | 渙 | 潤 | 潤 | 潤 | 潤 | 潤 | 潤 | 潤 | 潤 | 潤 | 潤 | 潤 | 潤 | 潤 | 潤 | 潤 | 潤 | 潤 | 潤 | 潤 | 潤 | 潤 | 潤 | 潤 | 潤 | 潤 | 潤 | 潤 | 潤 | 潤 | 潤 | 潤 | |
| B560 | 琛 | 琦 | 琨 | 琨 | 琨 | 琨 | 琨 | 琨 | 琨 | 琨 | 琨 | 琨 | 琨 | 琨 | 琨 | 琨 | 琨 | 琨 | 琨 | 琨 | 琨 | 琨 | 琨 | 琨 | 琨 | 琨 | 琨 | 琨 | 琨 | 琨 | 琨 | 琨 | | |
| B5A0 | | 窗 | 聒 | 聒 | 聒 | 聒 | 聒 | 聒 | 聒 | 聒 | 聒 | 聒 | 聒 | 聒 | 聒 | 聒 | 聒 | 聒 | 聒 | 聒 | 聒 | 聒 | 聒 | 聒 | 聒 | 聒 | 聒 | 聒 | 聒 | 聒 | 聒 | 聒 | | |
| B5C0 | 臺 | 聒 | 聒 | 聒 | 聒 | 聒 | 聒 | 聒 | 聒 | 聒 | 聒 | 聒 | 聒 | 聒 | 聒 | 聒 | 聒 | 聒 | 聒 | 聒 | 聒 | 聒 | 聒 | 聒 | 聒 | 聒 | 聒 | 聒 | 聒 | 聒 | 聒 | 聒 | | |
| B5E0 | 裁 | 菲 | 菲 | 菲 | 菲 | 菲 | 菲 | 菲 | 菲 | 菲 | 菲 | 菲 | 菲 | 菲 | 菲 | 菲 | 菲 | 菲 | 菲 | 菲 | 菲 | 菲 | 菲 | 菲 | 菲 | 菲 | 菲 | 菲 | 菲 | 菲 | 菲 | 菲 | | |
| B640 | 詔 | 詛 | 詛 | 詛 | 詛 | 詛 | 詛 | 詛 | 詛 | 詛 | 詛 | 詛 | 詛 | 詛 | 詛 | 詛 | 詛 | 詛 | 詛 | 詛 | 詛 | 詛 | 詛 | 詛 | 詛 | 詛 | 詛 | 詛 | 詛 | 詛 | 詛 | 詛 | | |
| B660 | 貽 | 軻 | 軻 | 軻 | 軻 | 軻 | 軻 | 軻 | 軻 | 軻 | 軻 | 軻 | 軻 | 軻 | 軻 | 軻 | 軻 | 軻 | 軻 | 軻 | 軻 | 軻 | 軻 | 軻 | 軻 | 軻 | 軻 | 軻 | 軻 | 軻 | 軻 | 軻 | | |
| B6A0 | | 間 | 間 | 間 | 間 | 間 | 間 | 間 | 間 | 間 | 間 | 間 | 間 | 間 | 間 | 間 | 間 | 間 | 間 | 間 | 間 | 間 | 間 | 間 | 間 | 間 | 間 | 間 | 間 | 間 | 間 | 間 | 間 | |
| B6C0 | 黃 | 黍 | 黍 | 黍 | 黍 | 黍 | 黍 | 黍 | 黍 | 黍 | 黍 | 黍 | 黍 | 黍 | 黍 | 黍 | 黍 | 黍 | 黍 | 黍 | 黍 | 黍 | 黍 | 黍 | 黍 | 黍 | 黍 | 黍 | 黍 | 黍 | 黍 | 黍 | | |
| B6E0 | 嗣 | 嗔 | 嗔 | 嗔 | 嗔 | 嗔 | 嗔 | 嗔 | 嗔 | 嗔 | 嗔 | 嗔 | 嗔 | 嗔 | 嗔 | 嗔 | 嗔 | 嗔 | 嗔 | 嗔 | 嗔 | 嗔 | 嗔 | 嗔 | 嗔 | 嗔 | 嗔 | 嗔 | 嗔 | 嗔 | 嗔 | 嗔 | | |
| B740 | 嫫 | 嫫 | 嫫 | 嫫 | 嫫 | 嫫 | 嫫 | 嫫 | 嫫 | 嫫 | 嫫 | 嫫 | 嫫 | 嫫 | 嫫 | 嫫 | 嫫 | 嫫 | 嫫 | 嫫 | 嫫 | 嫫 | 嫫 | 嫫 | 嫫 | 嫫 | 嫫 | 嫫 | 嫫 | 嫫 | 嫫 | 嫫 | | |
| B760 | 戲 | 戲 | 戲 | 戲 | 戲 | 戲 | 戲 | 戲 | 戲 | 戲 | 戲 | 戲 | 戲 | 戲 | 戲 | 戲 | 戲 | 戲 | 戲 | 戲 | 戲 | 戲 | 戲 | 戲 | 戲 | 戲 | 戲 | 戲 | 戲 | 戲 | 戲 | 戲 | 戲 | |
| B7A0 | | 楚 | 楚 | 楚 | 楚 | 楚 | 楚 | 楚 | 楚 | 楚 | 楚 | 楚 | 楚 | 楚 | 楚 | 楚 | 楚 | 楚 | 楚 | 楚 | 楚 | 楚 | 楚 | 楚 | 楚 | 楚 | 楚 | 楚 | 楚 | 楚 | 楚 | 楚 | | |
| B7C0 | 滅 | 溥 | 溥 | 溥 | 溥 | 溥 | 溥 | 溥 | 溥 | 溥 | 溥 | 溥 | 溥 | 溥 | 溥 | 溥 | 溥 | 溥 | 溥 | 溥 | 溥 | 溥 | 溥 | 溥 | 溥 | 溥 | 溥 | 溥 | 溥 | 溥 | 溥 | 溥 | | |
| B7E0 | 獅 | 猿 | 猿 | 猿 | 猿 | 猿 | 猿 | 猿 | 猿 | 猿 | 猿 | 猿 | 猿 | 猿 | 猿 | 猿 | 猿 | 猿 | 猿 | 猿 | 猿 | 猿 | 猿 | 猿 | 猿 | 猿 | 猿 | 猿 | 猿 | 猿 | 猿 | 猿 | | |
| B840 | 睹 | 暈 | 暈 | 暈 | 暈 | 暈 | 暈 | 暈 | 暈 | 暈 | 暈 | 暈 | 暈 | 暈 | 暈 | 暈 | 暈 | 暈 | 暈 | 暈 | 暈 | 暈 | 暈 | 暈 | 暈 | 暈 | 暈 | 暈 | 暈 | 暈 | 暈 | 暈 | | |
| B860 | 節 | 筠 | 筠 | 筠 | 筠 | 筠 | 筠 | 筠 | 筠 | 筠 | 筠 | 筠 | 筠 | 筠 | 筠 | 筠 | 筠 | 筠 | 筠 | 筠 | 筠 | 筠 | 筠 | 筠 | 筠 | 筠 | 筠 | 筠 | 筠 | 筠 | 筠 | 筠 | 筠 | |
| B8A0 | | 腹 | 腹 | 腹 | 腹 | 腹 | 腹 | 腹 | 腹 | 腹 | 腹 | 腹 | 腹 | 腹 | 腹 | 腹 | 腹 | 腹 | 腹 | 腹 | 腹 | 腹 | 腹 | 腹 | 腹 | 腹 | 腹 | 腹 | 腹 | 腹 | 腹 | 腹 | | |
| B8C0 | 蛻 | 蜂 | 蜂 | 蜂 | 蜂 | 蜂 | 蜂 | 蜂 | 蜂 | 蜂 | 蜂 | 蜂 | 蜂 | 蜂 | 蜂 | 蜂 | 蜂 | 蜂 | 蜂 | 蜂 | 蜂 | 蜂 | 蜂 | 蜂 | 蜂 | 蜂 | 蜂 | 蜂 | 蜂 | 蜂 | 蜂 | 蜂 | 蜂 | |
| B8E0 | 詮 | 話 | 話 | 話 | 話 | 話 | 話 | 話 | 話 | 話 | 話 | 話 | 話 | 話 | 話 | 話 | 話 | 話 | 話 | 話 | 話 | 話 | 話 | 話 | 話 | 話 | 話 | 話 | 話 | 話 | 話 | 話 | 話 | |
| B940 | 辟 | 農 | 農 | 農 | 農 | 農 | 農 | 農 | 農 | 農 | 農 | 農 | 農 | 農 | 農 | 農 | 農 | 農 | 農 | 農 | 農 | 農 | 農 | 農 | 農 | 農 | 農 | 農 | 農 | 農 | 農 | 農 | 農 | |
| B960 | 鉞 | 鈴 | 鈴 | 鈴 | 鈴 | 鈴 | 鈴 | 鈴 | 鈴 | 鈴 | 鈴 | 鈴 | 鈴 | 鈴 | 鈴 | 鈴 | 鈴 | 鈴 | 鈴 | 鈴 | 鈴 | 鈴 | 鈴 | 鈴 | 鈴 | 鈴 | 鈴 | 鈴 | 鈴 | 鈴 | 鈴 | 鈴 | 鈴 | |
| B9A0 | | 飽 | 飽 | 飽 | 飽 | 飽 | 飽 | 飽 | 飽 | 飽 | 飽 | 飽 | 飽 | 飽 | 飽 | 飽 | 飽 | 飽 | 飽 | 飽 | 飽 | 飽 | 飽 | 飽 | 飽 | 飽 | 飽 | 飽 | 飽 | 飽 | 飽 | 飽 | 飽 | |
| B9C0 | 嘛 | 嘗 | 嘗 | 嘗 | 嘗 | 嘗 | 嘗 | 嘗 | 嘗 | 嘗 | 嘗 | 嘗 | 嘗 | 嘗 | 嘗 | 嘗 | 嘗 | 嘗 | 嘗 | 嘗 | 嘗 | 嘗 | 嘗 | 嘗 | 嘗 | 嘗 | 嘗 | 嘗 | 嘗 | 嘗 | 嘗 | 嘗 | 嘗 | |
| B9E0 | 嫩 | 嫻 | 嫻 | 嫻 | 嫻 | 嫻 | 嫻 | 嫻 | 嫻 | 嫻 | 嫻 | 嫻 | 嫻 | 嫻 | 嫻 | 嫻 | 嫻 | 嫻 | 嫻 | 嫻 | 嫻 | 嫻 | 嫻 | 嫻 | 嫻 | 嫻 | 嫻 | 嫻 | 嫻 | 嫻 | 嫻 | 嫻 | 嫻 | |
| BA40 | 愿 | 態 | 態 | 態 | 態 | 態 | 態 | 態 | 態 | 態 | 態 | 態 | 態 | 態 | 態 | 態 | 態 | 態 | 態 | 態 | 態 | 態 | 態 | 態 | 態 | 態 | 態 | 態 | 態 | 態 | 態 | 態 | 態 | |
| BA60 | 搞 | 榮 | 榮 | 榮 | 榮 | 榮 | 榮 | 榮 | 榮 | 榮 | 榮 | 榮 | 榮 | 榮 | 榮 | 榮 | 榮 | 榮 | 榮 | 榮 | 榮 | 榮 | 榮 | 榮 | 榮 | 榮 | 榮 | 榮 | 榮 | 榮 | 榮 | 榮 | 榮 | |
| BAA0 | | 滿 | 滿 | 滿 | 滿 | 滿 | 滿 | 滿 | 滿 | 滿 | 滿 | 滿 | 滿 | 滿 | 滿 | 滿 | 滿 | 滿 | 滿 | 滿 | 滿 | 滿 | 滿 | 滿 | 滿 | 滿 | 滿 | 滿 | 滿 | 滿 | 滿 | 滿 | 滿 | |
| BAC0 | 瑰 | 瑤 | 瑤 | 瑤 | 瑤 | 瑤 | 瑤 | 瑤 | 瑤 | 瑤 | 瑤 | 瑤 | 瑤 | 瑤 | 瑤 | 瑤 | 瑤 | 瑤 | 瑤 | 瑤 | 瑤 | 瑤 | 瑤 | 瑤 | 瑤 | 瑤 | 瑤 | 瑤 | 瑤 | 瑤 | 瑤 | 瑤 | | |
| BAE0 | 箋 | 筵 | 筵 | 筵 | 筵 | 筵 | 筵 | 筵 | 筵 | 筵 | 筵 | 筵 | 筵 | 筵 | 筵 | 筵 | 筵 | 筵 | 筵 | 筵 | 筵 | 筵 | 筵 | 筵 | 筵 | 筵 | 筵 | 筵 | 筵 | 筵 | 筵 | 筵 | 筵 | |
| BB40 | 罰 | 翠 | 翠 | 翠 | 翠 | 翠 | 翠 | 翠 | 翠 | 翠 | 翠 | 翠 | 翠 | 翠 | 翠 | 翠 | 翠 | 翠 | 翠 | 翠 | 翠 | 翠 | 翠 | 翠 | 翠 | 翠 | 翠 | 翠 | 翠 | 翠 | 翠 | 翠 | 翠 | |
| BB60 | 蒐 | 蒼 | 蒼 | 蒼 | 蒼 | 蒼 | 蒼 | 蒼 | 蒼 | 蒼 | 蒼 | 蒼 | 蒼 | 蒼 | 蒼 | 蒼 | 蒼 | 蒼 | 蒼 | 蒼 | 蒼 | 蒼 | 蒼 | 蒼 | 蒼 | 蒼 | 蒼 | 蒼 | 蒼 | 蒼 | 蒼 | 蒼 | 蒼 | |
| BBA0 | | 說 | 說 | 說 | 說 | 說 | 說 | 說 | 說 | 說 | 說 | 說 | 說 | 說 | 說 | 說 | 說 | 說 | 說 | 說 | 說 | 說 | 說 | 說 | 說 | 說 | 說 | 說 | 說 | 說 | 說 | 說 | 說 | |
| BBC0 | 鄙 | 鄙 | 鄙 | 鄙 | 鄙 | 鄙 | 鄙 | 鄙 | 鄙 | 鄙 | 鄙 | 鄙 | 鄙 | 鄙 | 鄙 | 鄙 | 鄙 | 鄙 | 鄙 | 鄙 | 鄙 | 鄙 | 鄙 | 鄙 | 鄙 | 鄙 | 鄙 | 鄙 | 鄙 | 鄙 | 鄙 | 鄙 | 鄙 | |
| BBE0 | 韶 | 頗 | 頗 | 頗 | 頗 | 頗 | 頗 | 頗 | 頗 | 頗 | 頗 | 頗 | 頗 | 頗 | 頗 | 頗 | 頗 | 頗 | 頗 | 頗 | 頗 | 頗 | 頗 | 頗 | 頗 | 頗 | 頗 | 頗 | 頗 | 頗 | 頗 | 頗 | 頗 | |
| BC40 | 劇 | 劈 | 劈 | 劈 | 劈 | 劈 | 劈 | 劈 | 劈 | 劈 | 劈 | 劈 | 劈 | 劈 | 劈 | 劈 | 劈 | 劈 | 劈 | 劈 | 劈 | 劈 | 劈 | 劈 | 劈 | 劈 | 劈 | 劈 | 劈 | 劈 | 劈 | 劈 | 劈 | |
| BC60 | 彈 | 嫻 | 嫻 | 嫻 | 嫻 | 嫻 | 嫻 | 嫻 | 嫻 | 嫻 | 嫻 | 嫻 | 嫻 | 嫻 | 嫻 | 嫻 | 嫻 | 嫻 | 嫻 | 嫻 | 嫻 | 嫻 | 嫻 | 嫻 | 嫻 | 嫻 | 嫻 | 嫻 | 嫻 | 嫻 | 嫻 | 嫻 | 嫻 | 嫻 |
| BCA0 | | 感 | 感 | 感 | 感 | 感 | 感 | 感 | 感 | 感 | 感 | 感 | 感 | 感 | 感 | 感 | 感 | 感 | 感 | 感 | 感 | 感 | 感 | 感 | 感 | 感 | 感 | 感 | 感 | 感 | 感 | 感 | 感 | 感 |
| BCC0 | 搥 | 搥 | 搥 | 搥 | 搥 | 搥 | 搥 | 搥 | 搥 | 搥 | 搥 | 搥 | 搥 | 搥 | 搥 | 搥 | 搥 | 搥 | 搥 | 搥 | 搥 | 搥 | 搥 | 搥 | 搥 | 搥 | 搥 | 搥 | 搥 | 搥 | 搥 | 搥 | 搥 | 搥 |
| BCE0 | 撞 | 澄 | 澄 | 澄 | 澄 | 澄 | 澄 | 澄 | 澄 | 澄 | 澄 | 澄 | 澄 | 澄 | 澄 | 澄 | 澄 | 澄 | 澄 | 澄 | 澄 | 澄 | 澄 | 澄 | 澄 | 澄 | 澄 | 澄 | 澄 | 澄 | 澄 | 澄 | 澄 | 澄 |
| BD40 | 瑾 | 瑾 | 瑾 | 瑾 | 瑾 | 瑾 | 瑾 | 瑾 | 瑾 | 瑾 | 瑾 | 瑾 | 瑾 | 瑾 | 瑾 | 瑾 | 瑾 | 瑾 | 瑾 | 瑾 | 瑾 | 瑾 | 瑾 | 瑾 | 瑾 | 瑾 | 瑾 | 瑾 | 瑾 | 瑾 | 瑾 | 瑾 | 瑾 | 瑾 |
| BD60 | 窳 | 窳 | 窳 | 窳 | 窳 | 窳 | 窳 | 窳 | 窳 | 窳 | 窳 | 窳 | 窳 | 窳 | 窳 | 窳 | 窳 | 窳 | 窳 | 窳 | 窳 | 窳 | 窳 | 窳 | 窳 | 窳 | 窳 | 窳 | 窳 | 窳 | 窳 | 窳 | 窳 | 窳 |
| BDA0 | | 翮 | 翮 | 翮 | 翮 | 翮 | 翮 | 翮 | 翮 | 翮 | 翮 | 翮 | 翮 | 翮 | 翮 | 翮 | 翮 | 翮 | 翮 | 翮 | 翮 | 翮 | 翮 | 翮 | 翮 | 翮 | 翮 | 翮 | 翮 | 翮 | 翮 | 翮 | 翮 | 翮 |
| BDC0 | 蝗 | 蝗 | 蝗 | 蝗 | 蝗 | 蝗 | 蝗 | 蝗 | 蝗 | 蝗 | 蝗 | 蝗 | 蝗 | 蝗 | 蝗 | 蝗 | 蝗 | 蝗 | 蝗 | 蝗 | 蝗 | 蝗 | 蝗 | 蝗 | 蝗 | 蝗 | 蝗 | 蝗 | 蝗 | 蝗 | 蝗 | 蝗 | 蝗 | 蝗 |

n =3Dh Hangul(KSC5601)

| | +0 | +1 | +2 | +3 | +4 | +5 | +6 | +7 | +8 | +9 | +A | +B | +C | +D | +E | +F | +10 | +11 | +12 | +13 | +14 | +15 | +16 | +17 | +18 | +19 | +1A | +1B | +1C | +1D | +1E | +1F |
|------|-----|-----|-----|-----|-----|-----|-----|------|-----|-----|-----|-----|-----|-----|-----|-----|------|------|------|------|------|------|-----|-----|-----|-----|------|-----|-----|-----|-----|-----|
| A1A0 | □ | ◻ | ◼ | ◽ | ◾ | ◿ | ▰ | ▱ | ▲ | △ | ▴ | ▵ | ▶ | ▷ | ▸ | ▹ | ► | ▻ | ▼ | ▽ | ▾ | ▿ | ◀ | ▶ | ↔ | ↕ | ↖ | ↗ | ↘ | ↙ | ↚ | ↛ |
| A1C0 | ÷ | ≠ | ≤ | ≥ | ∞ | ∴ | ∅ | ∞ | ∞ | ∞ | ∞ | ∞ | ∞ | ∞ | ∞ | ∞ | ∞ | ∞ | ∞ | ∞ | ∞ | ∞ | ∞ | ∞ | ∞ | ∞ | ∞ | ∞ | ∞ | ∞ | ∞ | |
| A1E0 | □ | ■ | ▲ | ▼ | → | ← | ↑ | ↓ | ↔ | ≡ | ≪ | ≫ | √ | ∞ | ∞ | ∞ | ∞ | ∞ | ∞ | ∞ | ∞ | ∞ | ∞ | ∞ | ∞ | ∞ | ∞ | ∞ | ∞ | ∞ | | |
| A2A0 | ⇒ | ⇐ | ▽ | ◻ | ◻ | ◻ | ◻ | ◻ | ◻ | ◻ | ◻ | ◻ | ◻ | ◻ | ◻ | ◻ | ◻ | ◻ | ◻ | ◻ | ◻ | ◻ | ◻ | ◻ | ◻ | ◻ | ◻ | ◻ | ◻ | ◻ | | |
| A2C0 | ♣ | ♠ | ♦ | ♠ | ♠ | ♠ | ♠ | ♠ | ♠ | ♠ | ♠ | ♠ | ♠ | ♠ | ♠ | ♠ | ♠ | ♠ | ♠ | ♠ | ♠ | ♠ | ♠ | ♠ | ♠ | ♠ | ♠ | ♠ | ♠ | ♠ | | |
| A2E0 | No | Co | TM | am | pm | Tel | | | | | | | | | | | | | | | | | | | | | | | | | | |
| A3A0 | ! | " | # | \$ | % | & | ' | (|) | * | + | , | - | . | / | 0 | 1 | 2 | 3 | 4 | 5 | 6 | 7 | 8 | 9 | : | ; | < | = | > | ? | |
| A3C0 | @ | A | B | C | D | E | F | G | H | I | J | K | L | M | N | O | P | Q | R | S | T | U | V | W | X | Y | Z | [|] | ^ | _ | |
| A3E0 | | a | b | c | d | e | f | g | h | i | j | k | l | m | n | o | p | q | r | s | t | u | v | w | x | y | z | { | } | | | |
| A4A0 | ㄱ | ㅋ | ㆁ | ㄴ | ㄷ | ㄹ | ㅁ | ㅂ | ㅅ | ㅇ | ㅈ | ㅊ | ㅌ | ㅍ | ㅑ | ㅓ | ㅕ | ㅗ | ㅛ | ㅜ | ㅠ | ㅡ | ㅣ | ㅞ | ㅟ | ㅠ | ㅡ | ㅢ | ㅣ | ㅤ | ㅥ | |
| A4C0 | ㅦ | ㅧ | ㅨ | ㅩ | ㅪ | ㅫ | ㅬ | ㅭ | ㅮ | ㅯ | ㅰ | ㅱ | ㅲ | ㅳ | ㅴ | ㅵ | ㅶ | ㅷ | ㅸ | ㅹ | ㅺ | ㅻ | ㅼ | ㅽ | ㅾ | ㅿ | ㅿ | ㅿ | ㅿ | ㅿ | ㅿ | |
| A4E0 | ㅿ | ㅿ | ㅿ | ㅿ | ㅿ | ㅿ | ㅿ | ㅿ | ㅿ | ㅿ | ㅿ | ㅿ | ㅿ | ㅿ | ㅿ | ㅿ | ㅿ | ㅿ | ㅿ | ㅿ | ㅿ | ㅿ | ㅿ | ㅿ | ㅿ | ㅿ | ㅿ | ㅿ | ㅿ | ㅿ | ㅿ | |
| A5A0 | i | ii | iii | iv | v | vi | vii | viii | ix | x | | | | | | | | | | | | | | | | | | | | | | |
| A5C0 | A | B | Γ | Δ | E | Z | H | ⊙ | I | K | Λ | M | N | E | O | Π | P | Σ | T | Υ | Φ | X | Ψ | Ω | | | | | | | | |
| A5E0 | α | β | γ | δ | ε | ζ | η | θ | ι | κ | λ | μ | ν | ξ | ο | π | ρ | σ | τ | υ | φ | χ | ψ | ω | | | | | | | | |
| A6A0 | | | | | | | | | | | | | | | | | | | | | | | | | | | | | | | | |
| A6C0 | + | + | + | + | + | + | + | + | + | + | + | + | + | + | + | + | + | + | + | + | + | + | + | + | + | + | + | + | + | + | + | |
| A6E0 | + | + | + | + | + | | | | | | | | | | | | | | | | | | | | | | | | | | | |
| A7A0 | ul | ml | dl | l | kl | cc | mm | cm | m | km | fm | nm | um | mm | cm | km | mm | cm | m | km | ha | ug | mg | kg | kt | cal | kcal | dB | % | % | ps | |
| A7C0 | ns | us | ms | pv | nV | uV | mV | kV | MV | pA | nA | uA | mA | kA | pW | nW | uW | mW | kW | MW | Hz | kHz | MHz | GHz | THz | Ω | kΩ | MΩ | pF | nF | uF | mol |
| A7E0 | cd | rad | ° | ′ | ″ | sr | Pa | kPa | MPa | GPa | Wb | lm | lx | Bq | Gy | Sv | % | | | | | | | | | | | | | | | |
| A8A0 | Æ | Ð | Ǽ | Ɔ | Ɔ | Ɔ | Ɔ | Ɔ | Ɔ | Ɔ | Ɔ | Ɔ | Ɔ | Ɔ | Ɔ | Ɔ | Ɔ | Ɔ | Ɔ | Ɔ | Ɔ | Ɔ | Ɔ | Ɔ | Ɔ | Ɔ | Ɔ | Ɔ | Ɔ | Ɔ | | |
| A8C0 | Ⓐ | Ⓑ | Ⓒ | Ⓓ | Ⓔ | Ⓕ | Ⓖ | Ⓗ | Ⓘ | Ⓚ | Ⓛ | Ⓜ | Ⓝ | Ⓞ | Ⓟ | Ⓠ | Ⓡ | Ⓢ | Ⓣ | Ⓤ | Ⓥ | Ⓦ | Ⓧ | Ⓨ | Ⓩ | ⓐ | ⓑ | ⓒ | ⓓ | ⓔ | | |
| A8E0 | ⓕ | ⓖ | ⓗ | ⓘ | ⓙ | ⓚ | ⓛ | ⓜ | ⓝ | ⓞ | ⓟ | ⓠ | ⓡ | ⓢ | ⓣ | ⓤ | ⓥ | ⓦ | ⓧ | ⓨ | ⓩ | ⓪ | ⓫ | ⓬ | ⓭ | ⓮ | ⓯ | ⓰ | ⓱ | ⓲ | | |
| A9A0 | ⓴ | ⓵ | ⓶ | ⓷ | ⓸ | ⓹ | ⓺ | ⓻ | ⓼ | ⓽ | ⓾ | ⓿ | Ⓚ | Ⓛ | Ⓜ | Ⓝ | Ⓞ | Ⓟ | Ⓠ | Ⓡ | Ⓢ | Ⓣ | Ⓤ | Ⓥ | Ⓦ | Ⓧ | Ⓨ | Ⓩ | ⓐ | ⓑ | | |
| A9C0 | ⓞ | ⓟ | ⓠ | ⓡ | ⓢ | ⓣ | ⓤ | ⓥ | ⓦ | ⓧ | ⓨ | ⓩ | ⓪ | ⓫ | ⓬ | ⓭ | ⓮ | ⓯ | ⓰ | ⓱ | ⓲ | ⓳ | ⓴ | ⓵ | ⓶ | ⓷ | ⓸ | ⓹ | ⓺ | ⓻ | | |
| A9E0 | (t) | (u) | (v) | (w) | (x) | (y) | (z) | (1) | (2) | (3) | (4) | (5) | (6) | (7) | (8) | (9) | (10) | (11) | (12) | (13) | (14) | (15) | ¹ | ² | ³ | ⁴ | ⁿ | ₁ | ₂ | ₃ | ₄ | |
| AAA0 | ㅏ | ㅑ | ㅓ | ㅕ | ㅗ | ㅛ | ㅜ | ㅠ | ㅡ | ㅣ | ㅞ | ㅟ | ㅠ | ㅡ | ㅢ | ㅣ | ㅤ | ㅥ | ㅦ | ㅧ | ㅨ | ㅩ | ㅪ | ㅫ | ㅬ | ㅭ | ㅮ | ㅯ | ㅰ | ㅱ | ㅲ | |
| AAC0 | ㅳ | ㅴ | ㅵ | ㅶ | ㅷ | ㅸ | ㅹ | ㅺ | ㅻ | ㅼ | ㅽ | ㅾ | ㅿ | ㅿ | ㅿ | ㅿ | ㅿ | ㅿ | ㅿ | ㅿ | ㅿ | ㅿ | ㅿ | ㅿ | ㅿ | ㅿ | ㅿ | ㅿ | ㅿ | ㅿ | ㅿ | |
| AAE0 | ㅿ | ㅿ | ㅿ | ㅿ | ㅿ | ㅿ | ㅿ | ㅿ | ㅿ | ㅿ | ㅿ | ㅿ | ㅿ | ㅿ | ㅿ | ㅿ | ㅿ | ㅿ | ㅿ | ㅿ | ㅿ | ㅿ | ㅿ | ㅿ | ㅿ | ㅿ | ㅿ | ㅿ | ㅿ | ㅿ | ㅿ | |
| ABA0 | ㅿ | ㅿ | ㅿ | ㅿ | ㅿ | ㅿ | ㅿ | ㅿ | ㅿ | ㅿ | ㅿ | ㅿ | ㅿ | ㅿ | ㅿ | ㅿ | ㅿ | ㅿ | ㅿ | ㅿ | ㅿ | ㅿ | ㅿ | ㅿ | ㅿ | ㅿ | ㅿ | ㅿ | ㅿ | ㅿ | ㅿ | |
| ABC0 | ㅿ | ㅿ | ㅿ | ㅿ | ㅿ | ㅿ | ㅿ | ㅿ | ㅿ | ㅿ | ㅿ | ㅿ | ㅿ | ㅿ | ㅿ | ㅿ | ㅿ | ㅿ | ㅿ | ㅿ | ㅿ | ㅿ | ㅿ | ㅿ | ㅿ | ㅿ | ㅿ | ㅿ | ㅿ | ㅿ | ㅿ | |
| ABE0 | ㅿ | ㅿ | ㅿ | ㅿ | ㅿ | ㅿ | ㅿ | ㅿ | ㅿ | ㅿ | ㅿ | ㅿ | ㅿ | ㅿ | ㅿ | ㅿ | ㅿ | ㅿ | ㅿ | ㅿ | ㅿ | ㅿ | ㅿ | ㅿ | ㅿ | ㅿ | ㅿ | ㅿ | ㅿ | ㅿ | ㅿ | |
| ACA0 | A | B | V | Г | Д | E | Ё | Ж | З | И | Й | К | Л | М | Н | О | П | Р | С | Т | У | Ф | Х | Ц | Ч | Ш | Щ | Ъ | Ы | Ь | Э | |
| ACC0 | Ю | Я | | | | | | | | | | | | | | | | | | | | | | | | | | | | | | |
| ACE0 | О | П | р | с | т | у | ф | х | ц | ч | ш | щ | ъ | ы | ь | э | ю | я | | | | | | | | | | | | | | |
| ADA0 | | | | | | | | | | | | | | | | | | | | | | | | | | | | | | | | |
| ADC0 | | | | | | | | | | | | | | | | | | | | | | | | | | | | | | | | |
| ADE0 | | | | | | | | | | | | | | | | | | | | | | | | | | | | | | | | |
| AEA0 | | | | | | | | | | | | | | | | | | | | | | | | | | | | | | | | |
| AEC0 | | | | | | | | | | | | | | | | | | | | | | | | | | | | | | | | |
| AEE0 | | | | | | | | | | | | | | | | | | | | | | | | | | | | | | | | |
| AFA0 | | | | | | | | | | | | | | | | | | | | | | | | | | | | | | | | |
| AFC0 | | | | | | | | | | | | | | | | | | | | | | | | | | | | | | | | |
| AFE0 | | | | | | | | | | | | | | | | | | | | | | | | | | | | | | | | |
| BOA0 | 가 | 각 | 간 | 감 | 갈 | 값 | 값 | 감 | 갑 | 값 | 갓 | 갓 | 장 | 값 | 값 | 갈 | 값 | 값 | 값 | 개 | 객 | 겐 | 겉 | 겉 | 겉 | 겉 | 갹 | 갹 | 갹 | 갹 | 갹 | |
| BOC0 | 갹 | 갹 | 갹 | 갹 | 갹 | 갹 | 갹 | 갹 | 갹 | 갹 | 갹 | 갹 | 갹 | 갹 | 갹 | 갹 | 갹 | 갹 | 갹 | 갹 | 갹 | 갹 | 갹 | 갹 | 갹 | 갹 | 갹 | 갹 | 갹 | 갹 | 갹 | |
| BOE0 | 갹 | 갹 | 갹 | 갹 | 갹 | 갹 | 갹 | 갹 | 갹 | 갹 | 갹 | 갹 | 갹 | 갹 | 갹 | 갹 | 갹 | 갹 | 갹 | 갹 | 갹 | 갹 | 갹 | 갹 | 갹 | 갹 | 갹 | 갹 | 갹 | 갹 | 갹 | |

6. 保証 WARRANTY

保証期間は弊社出荷後 1 年とする。

This display module is guranteed for 1 year after the shipment from FUTABA.

7. 規制物資等の該非判定及び、輸出する際の注意事項

CAUTIONS FOR DETERMINING AND EXPORTING REGULATED GOODS OR SERVICES

本製品は、技術レベル的には外国為替管理令および輸出貿易管理令の規制上の物資（役務）等に非該当となりますが、他の装置の為に特別に設計した部分品・付属品はその装置の該・非判定により決定されます。

本製品を貴社製装置にご使用頂く弊社製汎用品に付きましては、貴社にて該・非判定をお願いすると共に、汎用品についても兵器等の製造に転用されることのないようご確認をお願い申し上げます。また、その結果、必要に応じた輸出手続等のご処置も併せてお願い申し上げます。

This product does not correspond to the goods or services regulated by Japan's Foreign Exchange and Foreign Trade Law. If this product is combined with other products in order to make equipment, whether this product is regulated or not is judged by such newly made equipment. We ask you to determine by yourself whether the equipment corresponds to the regulated goods when this product is incorporated in the equipment. We also ask you to confirm that this product will not be incorporated in any weapon or used for manufacturing any weapon. If you export or re-export this product, we recommend you to adopt measures for appropriate export procedures, if any

8. 環境対応 ENVIRONMENTALLY CONSCIENTIOUS

本製品は RoHS 適合品です。

This Module complies with RoHS Directive.

8.1 EU RoHS 指令に対して With respect to EU RoHS Directive

含有禁止物質である6物質(カドミウム、六価クロム、鉛、水銀、ポリ臭化ビフェニル類(PBB 類)、ポリ臭化ジフェニルエーテル類(PBDE 類))が RoHS 指令に規定される許容値以下、又は、適用除外項目に相当します。

EU RoHS 指令の適用除外については、EU RoHS 指令第4条に準ずるものが対象となります。

The contained amount of six prohibited substances in this product , which are cadmium, hexavalent chromium, lead, mercury, polybrominated biphenyl: PBB and polybrominated diphenyl ether :PBDE, is less than the permitted level stipulated in the EU RoHS Directive, or these substances are not included in the Directive.

The substances excluded are based on Article 4 of the EU RoHS Directive.

8.2 中国RoHS に対して With respect to Chinese RoHS

規制物質である6物質(カドミウム、六価クロム、鉛、水銀、ポリ臭化ビフェニル類(PBB 類)、ポリ臭化ジフェニルエーテル類(PBDE 類))の内「鉛及びその化合物」が含まれています。「鉛及びその化合物」以外の規制物質は中国RoHS に規定される閾値以下です。

EHS 含有情報の表示は以下を参照下さい。

<EHS 含有情報の表示>

含有部位: 蛍光表示管 (VFD)

含有化学物質: 鉛及びその化合物

環境保護使用期限年数: 10年

含有理由: 現代の技術では代替できる物質がないため

This product contains only “lead and its compound” from among six controlled substances, which are cadmium, hexavalent chromium, lead, mercury, polybrominated biphenyl: PBB and polybrominated diphenyl ether :PBDE.

The contained amount of the controlled substances except lead and its compound in this product is less than the level stipulated in the Chinese RoHs.

As for the display of information on containing EHS, please refer to the following.

< Display of information on containing EHS >

*Product and part the substances are contained : Vacuum Fluorescent Display(VFD)

*Chemical materials contained : Lead and its compound

*Time limit of use for environmental protection : 10 years

*Reason for containing the substances: No materials are available except them under the current technology.

9. 使用上の注意事項 CAUTIONS FOR OPERATION

9-1. モジュールに取り付けられている蛍光表示管はガラス製品ですので、規定値以上の振動や衝撃を加えると破損することがあります。

規定値以上の振動や衝撃を加えないように十分注意して取り扱って下さい。

Since VFD is made of glass material, avoid applying excessive shock or vibration beyond the specification for the module. Careful handling is essential.

9-2. 電源電圧が規定値より低すぎる場合、点灯すべきドットが点灯しない場合があります。また逆に高すぎる場合は点灯すべきでないドットが点灯する場合があります。このような現象が見られる場合には、電源電圧をチェックして規定の値にセットしてください。

Applying lower voltage than the specified may cause non activation for selected pixels.

Conversely, higher voltage may cause non-selected pixel to be activated.

If such a phenomenon is observed, check the voltage level of the power supply.

9-3. 電圧 V_{cc} の立ち上がりが遅いと正しい動作をしない場合がありますので、30ms 以内に規定電圧に立ち上がる電源が必要です。

If the startup time of the supply voltage is slow, the controller may not be reset.

The supply voltage must be risen up to specified voltage level within 30msec.

9-4. RS232C 仕様の場合、電源投入時約 5 倍のサージ電流が流れることがあります。

Case of the RS232C type, the surge current may be approximately 5 times the specified supply current at the power on.