

# APPLICATION NOTE

## FSTN LCD DISPLAY MODULE

スリムデザインディスプレイモジュール  
SLIM DESIGN DISPLAY MODULE

AH147AA/AB/AC/  
BA/BB/BC

### 概要 GENERAL DESCRIPTION

スリムデザインディスプレイモジュール  
『AH147AA/AB/AC/BA/BB/BC』は、FSTN-LCD を使用した  
160×40ドットを表示するモジュールです。  
このモジュールは、FSTN-LCD、ワンチップコントローラーと電源  
(DC-DC/AC コンバータ)から構成されておりますので、ホスト CPU と  
容易に接続することができます。

#### Slim Design Display Module

『AH147AA/AB/AC/BA/BB/BC/』 with FSTN-LCD display, produces  
160×40 dots.

This module is composed of FSTN-LCD, one chip controller, power  
supply (DC-DC/AC converter), is easy to connect to host CPU.



## 安全にお使いいただくために Important Safety Notice

安全に御使用頂く為に必ず本書をお読み下さい。  
また、本書はお読みになった後も大切に保管して下さい。  
Please read this note carefully before using the product.

### 警告 Warning

- 感電およびショートによる破損の恐れがある為、製品の金属部分に直接人体が触れないようにして頂くとともに、製品の基板上の部分が他の金属部品と接触しない様にして下さい。

There is fear of breakage by an electric shock and electrical short circuit.

Please prevent from touching a human body directly at the metallic portion of a product.

Please keep a product from contacting metal parts.

- モジュールの電源回路には、コンデンサが接続されております。  
電源を切った後、直ちに回路をショートするとIC等を破損する事があります。  
(放電には30秒程度の時間を要します) また、感電の恐れがありますので、製品の金属部分に直接人体が触れないようにして下さい。

After turning off the power, Electronic components may be damaged if a circuit is short-circuited.

Do not touch the electronic components of the module with any metal objects.

- モジュールには保護素子が搭載されており、何らかの不具合が発生した場合、保護素子が働き、事故を未然に防ぎます。

The module is equipped with a circuit protection Reset table Fuse.

- 外部の電源を入れたまま（又はモジュールの電源を入れたまま）電源ケーブルを抜き差しすることは絶対に避けて下さい。感電の原因になります。

The power supply should be switched off before connecting or disconnecting the power or interface cables.

- 分解、修理、改造は絶対にしないで下さい。感電や火災の原因になります。

Under no circumstances should the module be modified or repaired.

Any unauthorized modifications or repairs will invalidate the product warranty.

- 廃棄する場合には、特別管理産業廃棄物として処理して下さい。

The module should be abolished as the factory waste.

# 目 次

## CONTENTS

---

1. 特長 FEATURES	1
----------------	---

---

2. 一般仕様 GENERAL SPECIFICATIONS	
2-1. 外形寸法・重量 DIMENSION, WEIGHT	1
2-2. 製品種類 TYPE VARIATION	2
2-3. 表示部仕様 SPECIFICATION OF THE DISPLAY	2
2-4. 環境条件 ENVIRONMENT CONDITIONS	2
2-5. 絶対最大定格 ABSOLUTE MAXIMUM ELECTRICAL	3
2-6. 推奨動作条件 RECOMMEND OPERATING CONDITIONS	3
2-7. 標準動作条件における電氣的、光学的特性 ELECTRICAL CHARACTERISTICS	4

---

3. 基本機能 FUNCTION SUMMARY	
3-1. RS232C インターフェース RS232C INTERFACE	5
3-1-1. 受信の条件 DATA RECEPTION	5
3-1-2. 異常時の処理 COMMUNICATION ERROR	5
3-2. USB インターフェース USB INTERFACE	6
3-2-1. USB-HID	6
3-2-2. USB ディスクリプタ仕様 USB DESCRIPTOR SPECIFICATION	7
3-3. Bluetooth(iAP)インターフェース BLUETOOTH(iAP) INTERFACE	11
3-3-1. インターフェース INTERFACE	11
3-3-2. 電波法認証 RADIO AUTHENTICATION METHOD	11
3-3-3. Bluetooth 仕様 BLUETOOTH SPECIFICATION	12
3-3-4. Bluetooth 動作状態説明 BLUETOOTH OPERATING STATE DESCRIPTION	13
3-3-4-1. BT_STATUS_LED	13
3-3-4-2. BT_RENEW_SW	14
3-3-4-3. BT_CONNECT_SW	14
3-3-5. iAP Accessory 設定 iAP ACCESSORY SETTINGS	15
3-3-6. セキュリティ仕様 SECURITY	15

3-3-7. ペアリング仕様 PAIRING SPECIFICATION	15
4. コマンド COMMAND	
4-1. コマンド詳細 FUNCTION OF COMMANDS	16
5. コネクタ接続 CONECTER CONNECTION	
5-1. RS232C TYPE (AH147AA/BA)	33
5-2. USB TYPE (AH147AB/BB)	34
5-3. BLUETOOTH (iAP) TYPE (AH147AC/BC)	35
FIGURE-1 外形図 Outer Dimensions	36
FIGURE-2 外形図 Outer Dimensions	37
FIGURE-3 ブロック図 RS232C Type (AH147AA/BA) Block Diagram	38
FIGURE-4 ブロック図 USB Type (AH147AB/BB) Block Diagram	39
FIGURE-5 ブロック図 BLUETOOTH(iAP) type (AH147mAC/BC) Block Diagram	40
FIGURE-6 Font Table	41
6. 保証 WARRANTY	74
7. 規制物資等の該非判定及び、輸出する際の注意事項 CAUTIONS FOR DETERMINING AND EXPORTING REGULATED GOODS OR SERVICES	74
8. 環境対応 ENVIRONMENTALLY	74
9. 使用上の注意事項	75

## 1. 特徴 FEATURES

- 1-1. 本製品は 160×40ドット、0.64×0.64ピッチの FSTN-LCD で構成されているケース付モジュールです。

FSTN-LCD module with case consists of a 160×40 number of pixels, 0.64×0.64 pitch dot matrix display.

- 1-2. 本製品のホスト間との通信プロトコルは RS232C、USB2.0 Full Speed Function、Bluetooth 3.0 に準拠しております。

This module supports RS232C, USB2.0 Full Speed Function, Bluetooth 3.0 interface.

- 1-3. 本製品で表示画面を維持する場合は、定期的に関係表示画面を送信することを推奨します。

If you want to keep the display in this module, it is recommended that you regularly send the same display.

- 1-4. 電源は USB バスパワー(5V/500mA)で動作可能です。

Power supply is capable of operating on USB bus power (5V / 500mA).

- 1-5. 本製品には下表の文字フォントを搭載しております。

This module is mounted the character font of below table.

Table-1

1 バイト文字 1 byte character				2 バイト文字 2 byte character	
番号 No.	フォント Font	番号 No.	フォント Font	番号 No.	フォント Font
1	USA	13	Latin America	1	Japanese font(shift JIS)
2	France	14	Korea	2	Simplified Chinese(GB2312)
3	Germany	15	PC437 (USA: Standard Europe)	3	Traditional Chinese(Big5)
4	Great Britain	16	Katakana	4	Hangul(KSC5601)
5	Denmark 1	17	PC850 (Multilingual)		
6	Sweden	18	PC860 (Portuguese)		
7	Italy	19	PC863(Canadian-French)		
8	Spain 1	20	PC865 (Norwegian)		
9	Japan	21	WPC1252		
10	Norway	22	PC866 [Cyrillic #2]		
11	Denmark 2	23	PC852 [Latin 2]		
12	Spain 2	24	PC858		

## 2. 一般仕様 GENERAL SPECIFICATION

### 2-1. 外形寸法・重量 DIMENSIONS, WEIGHT (Refer to FIGURE-1)

Table-2

項目 Parameter	仕様 Specification	単位 Unit
外形寸法 Outer Dimensions (NOTE1)	(W)141±0.5 (H)79±1 (T)60±0.5	mm
重量 Weight	Approx.210	g

NOTE1) 外形寸法(T)と重量は、配線クランプと電源コードを含みません。

Outer Dimensions (T) does not include the wiring clamp and power supply cable.

## 2-2. 製品種類 MODEL VARIATION

Table-3

製品番号 TYPE No.	ケース色 Case Color	インターフェース I/F	付属ケーブル Supplied cable	ケーブル色 Cable Color
AH147AA	White	RS232C	Not support	—
AH147BA	Black	RS232C	Not support	—
AH147AB	White	USB	USB type A to Mini B cable	White
AH147BB	Black	USB	USB type A to Mini B cable	Black
AH147AC	White	Bluetooth(iAP)	USB type A to Mini B cable	White
AH147BC	Black	Bluetooth(iAP)	USB type A to Mini B cable	Black

## 2-3. 表示部仕様 SPECIFICATION OF THE DISPLAY

Table-4

項目 Parameter	仕様 Specification	単位 Unit
画面仕様 Display Specification	FSTN / NEGATIVE / TRANSMISSIVE	—
ビューエリア View Area	106.40 (W)×29.6(H)	mm
アクティブエリア Active Area	102.38 (W)×25.58(H)	mm
画素数 Number of Pixels	160 (W)×40(H)	Dot
ドットサイズ Dot size	0.615(W)×0.615(H)	mm
ドットピッチ Dot pitch	0.64(W)×0.64(H)	mm
バックライト Backlight	LED	—
バックライト色 Backlight Color	White	—
コントラスト Contrast(Note 2)	4.5	—
視野角 View Angle (Note 3) Cr ≥ 3	Bottom=40,Top=40, Left=35,Right=35	deg

Note2)  $\theta_x = \theta_y = 0^\circ$  Ta=25°C.

Note3) Bottom は付図-1 の㊶側になります。 Bottom will be ㊶ side of Figure 1.

## 2-4. 環境条件 ENVIRONMENT CONDITIONS

Table-5

項目 Parameter	記号 Symbol	最小 Min.	最大 Max.	単位 Unit
動作温度 Operation Temperature	Topr	0	+40	°C
保存温度 Storage Temperature	Tstg	-20	+70	°C
動作湿度 Operation Humidity	Hopr	20	85	%
保存湿度 Storage Humidity(Note4)	Hstg	20	90	%
振動 Vibration (10~55Hz)	—	—	4	G
衝撃 Shock	—	—	40	G

Note4) 結露無きこと。 Avoid operations and or storage in moist environmental conditions.

## 2-5. 絶対最大定格 ABSOLUTE MAXIMUM ELECTRICAL RATINGS

Table-6

項目 Parameter	記号 Symbol	最小 Min.	最大 Max.	単位 Unit
電源電圧 Supply Voltage	Vcc	-0.3	+6.0	Vdc
入力信号電圧 (RS232C) Input Signal Voltage (RS232C)	V <sub>IS</sub>	-15	+15	Vdc
入力信号電圧 (USB) Input Signal Voltage (USB)	V <sub>IS</sub>	-0.3	+3.6	Vdc

## 2-6. 推奨動作条件 RECOMMEND OPERATING CONDITIONS

Table-7

項目 Parameter	記号 Symbol	最小 Min.	標準 Typ.	最大 Max.	単位 Unit
電源電圧 Supply Voltage	Vcc	4.75	5.0	5.25	Vdc

## 2-7. 標準動作条件における電氣的、光学的特性 ELECTRICAL CHARACTERISTICS

Table-8

項目 Parameter	記号 Symbol	条件 Condition	最小 Min.	標準 Typ.	最大 Max.	単位 Unit
消費電流 Supply Current (Note 5)	I <sub>cc</sub>	V <sub>cc</sub> =5.0V All on	—	70	100	mA
消費電力 Power Consumption	—		—	0.35	0.5	W
輝度 Luminance (Note 6)	L		65	130	—	cd/m <sup>2</sup>
色度(白) White Chromaticity	X Y	$\theta = 0^\circ$ $\theta = 0^\circ$	0.26 0.26	— —	0.36 0.36	— —
バックライト寿命 LED Life Time (Note7)	—	T <sub>a</sub> =25°C	30,000	—	—	hrs
応答時間 Response Time	Tr Tf	T <sub>a</sub> =25°C	— —	150 110	— —	ms
入力 H レベル電圧 (RS232C) H-level input Voltage (RS232C)	V <sub>IH</sub>		V <sub>cc</sub> =5.0V	2.0	—	15
入力 L レベル電圧 (RS232C) L-level input Voltage (RS232C)	V <sub>IL</sub>	V <sub>cc</sub> =5.0V	-15	—	0.8	
出力電圧 (RS232C) Output Voltage (RS232C)	V <sub>O</sub>	All driver outputs loaded with 3kΩ to GND	±5.0	±5.4	—	
入力 H レベル電圧 (USB) H-level input Voltage (USB)	V <sub>IH</sub>	V <sub>cc</sub> =5.0V	2.0	—	—	
入力 L レベル電圧 (USB) L-level input Voltage (USB)	V <sub>IL</sub>	V <sub>cc</sub> =5.0V	—	—	0.8	
差動入力感度 (USB) Differential Input Sensitivity (USB)	V <sub>DI</sub>	V <sub>cc</sub> =5.0V	0.2	—	—	

Note5) RS232C 仕様の場合、電源投入時に最大電流の約 5 倍の突入電流が発生します。

USB/Bluetooth 仕様の場合、電源電圧部に 10μF 以下の容量があり、電源投入時に突入電流が発生します。

Case of the RS232C type, the surge current can be approx. 5 times the supply current (Max.) at power on.

Case of the USB/Bluetooth type, the capacity of 10 or less is in a power supply circuit of module. Inrush current occurs in power-on.

Note6) 輝度レベル 100%の輝度値を示す。フィルタなしの値とする。フィルタの透過率は 93%となります。

The luminance level is set at 100% luminance value. It will be the value without the filter. Transmittance of the filter is 93%.

Note7) 期待寿命は標準輝度の 50%に達する時間となります。

The expected LED life time is defined as the module luminance decrease to 50% original luminance at T<sub>a</sub>=25°C.



### 3. 基本機能 FUNCTION SUMMARY

#### 3-1. RS232C インターフェース RS232C INTERFACE

Table-9

項目 Parameter	仕様 Specification
Signal level	RS-232C 準拠 RS-232C conformity
Baud Rate	38,400 bps
Parity bit	NON
Data bit length	8 bit(LSB first)
Format	Start(1bit)+Data(8bit)+Stop(1bit)

##### 3-1-1. 受信の条件 DATA RECEPTION

本モジュールには 256byte の受信バッファを持っています。

The module has 256 bytes buffers for data reception.

##### 3-1-2. 異常時の処理 COMMUNICATION ERROR

- a) モジュールから送信されたデータが、伝送上の理由でホストに受信されなかった場合、そのデータについては、モジュールは伝送済みのデータとして扱います。

When transferred data cannot be received properly at host system by the reason of the transmission failure, the module makes it the transmitted data.

- b) ホストからコマンド受信時にオーバーラン、フレーミングエラーが発生した場合、そのコマンドを無視します。

In case of the command reception, when the overrun or the framing error occurs, the command is ignored.

- c) ホストからデータ受信時にオーバーラン、フレーミングエラーが発生した場合は、そのデータを無視します。

In case of the display data reception, when the overrun or the framing error occurs, the display data is ignored.

- d) ホストからコマンド受信時にパリティエラーが発生した場合は、そのコマンドを無視します。

In case of the command reception, when the parity error occurs, the command is ignored.

- e) ホストからデータ受信時にパリティエラーが発生した場合は、そのデータを無視します。

In case of the display data reception, when the parity error occurs, the display data is ignored.

- f) ホストからイリガルコマンドを受信した場合は、そのコマンドを無視します。

When an illegal command is received, the command is ignored.



### 3-2-2. USB ディスクリプタ仕様 USB DESCRIPTOR SPECIFICATION.

Standard Device Descriptor

Table-10

Offset	Field	Description	Size[byte]	Value	Comment
0	bLength	Size of descriptor in bytes	1	12H	
1	bDescriptorType	DEVICE Descriptor Type	1	01H	
2	bcdUSB	USB Release Number in BCD	2	0200H	Rev.2.0
4	bDeviceClass	Class code	1	00H	
5	bDeviceSubClass	Subclass code	1	00H	
6	bDeviceProtocol	Protocol code	1	00H	
7	bMaxPacketSize	Maximum packet size for endpoint zero	1	40H	64 bytes
8	idVendor	Vendor ID	2	1008H	FUTABA
10	idProduct	Product ID	2	1028H	LC008A
12	bcdDevice	Device release number in BCD	2	0200H	Rev.2.00
14	iManufacturer	Index of string descriptor describing manufacturer	1	01H	
15	iProduct	Index of string descriptor describing product	1	02H	
16	iSerialNumber	Index of string descriptor describing the device's serial number	1	00H	
17	bNumConfigurations	Number of possible configurations	1	01H	

Standard Configuration Descriptor

Table-11

Offset	Field	Description	Size[byte]	Value	Comment
0	bLength	Size of this descriptor in bytes	1	09H	
1	bDescriptorType	CONFIGURATION Descriptor Type	1	02H	
2, 3	wTotalLength	Total length of data returned for this configuration	2	0029H	41 bytes
4	bNumInterfaces	Number of interfaces supported by this configuration	1	01H	
5	bConfigurationValue	Value to use as an argument	1	01H	
6	iConfiguration	Index of string descriptor describing this configuration	1	00H	
7	bmAttributes	Configuration characteristics	1	80H	Bus-powered
8	bMaxPower	Maximum power consumption	1	FAH	500mA

Interface Descriptor

Table-12

Offset	Field	Description	Size[Byte]	Value	Comment
0	bLength	Size of this descriptor in bytes	1	09H	
1	bDescriptorType	INTERFACE Descriptor Type	1	04H	
2	bInterfaceNumber	Number of this interface	1	00H	
3	bAlternateSetting	Value used to select this alternate setting	1	00H	
4	bNumEndpoints	Number of endpoints used by this interface	1	02H	
5	bInterfaceClass	Class code	1	03H	HID
6	bInterfaceSubClass	Subclass code	1	00H	
7	bInterfaceProtocol	Protocol code	1	00H	
8	iInterface	Index of string descriptor describing this interface	1	00H	

HID Descriptor

Table-13

Offset	Field	Description	Size[Byte]	Value	Comment
0	bLength	Size of HID descriptor	1	09H	
1	bDescriptorType	HID descriptor type	1	21H	HID Class descriptor
2	bcdHID	HID class specification	2	0111H	HID Revision 1.11
4	bCountry	Country code of the localized hardware	1	00H	Not defined
5	bNumDescriptors	Number of class descriptors	1	01H	1 report descriptor
6	bReportType	Type of class descriptor	1	22H	REPORT descriptor
7	wReportLength	Descriptor length	2	002FH	47 bytes

Endpoint Descriptor

Table-14

Offset	Description	Size[Byte]	Value	Comment
0	Size of this descriptor in bytes	1	07H	
1	ENDPOINT Descriptor Type	1	05H	
2	The address of the endpoint on the USB device described by this descriptor	1	87H	EP7, IN
3	The endpoint's attributes	1	03H	Interrupt Transfer
4	Maximum packet size this endpoint	2	0040H	64 bytes
6	Interval for polling endpoint for data transfers	1	04H	4[ms]

Endpoint Descriptor

Table-15

Offset	Description	Size[Byte]	Value	Comment
0	Size of this descriptor in bytes	1	07H	
1	ENDPOINT Descriptor Type	1	05H	
2	The address of the endpoint on the USB device described by this descriptor	1	06H	EP6, OUT
3	The endpoint's attributes	1	03H	Interrupt Transfer
4	Maximum packet size this endpoint	2	0040H	64 bytes
6	Interval for polling endpoint for data transfers	1	04H	4[ms]

HID Report Descriptor

Table-16

Part	Value (HEX)
Usage Page(Vendor-defined),	06 FF FF
Usage (VFD_CONTROL),	09 00
Collection (Application),	A1 01
Usage (DATA_INPUT),	09 02
Logical Minimum (0),	15 00
Logical Maximum (255),	26 FF 00
Report Size (8),	75 08
Report Count (64),	95 40
Input (Data,Variable,Absolute),	81 02
Usage (DATA_OUTPUT),	09 03
Logical Minimum (0),	15 00
Logical Maximum (255),	26 FF 00
Report Size (8),	75 08
Report Count (64),	95 40
Output (Data,Variable,Absolute),	91 02
Usage (FEATURE),	09 04
Logical Minimum (0),	15 00
Logical Maximum (255),	26 FF 00
Report Size (8),	75 08
Report Count (64),	95 40
Feature(Data,Variable,Absolute),	B1 02
End Collection	C0

String Descriptor

Table-17

No	Part	Description	Value
No.0	bLength	Length	0x04
	bDescriptorType	type=STRING	0x03
	bSting	LangID (English US)	0x0409
No.1	bLength	Length	0x0E
	bDescriptorType	Type=STRING	0x03
	bSting	Manufacturer	FUTABA
No.2	bLength	Length	0x0E
	bDescriptorType	Type=STRING	0x03
	bSting	Product	LC008A

### 3-3. Bluetooth(iAP)インターフェース BLUETOOTH(iAP) INTERFACE

#### 3-3-1. インターフェース INTERFACE

本モジュールのホスト間との通信プロトコルは Bluetooth 3.0 に準拠しております。

本製品の Bluetooth(iAP)対応機種は iPad Air, iPad Air2 となります。

本製品は、全ての Bluetooth 対応機器との接続を保証するものではありません。

This module supports Bluetooth 3.0 interface.

Bluetooth (iAP) support model of this module becomes iPad Air, iPad Air2.

Not guaranteed to connect to all Bluetooth devices.

#### 3-3-2. 電波法認証 RADIO AUTHENTICATION METHOD

本製品は日本(工事設計認証)、米国(FCC)、カナダ(IC)の各種認証を取得済み、および欧州(CE)

規格の適合確認済みです。以下に各国の電波法で仕様書への必要事項について記載します。

This product is Japan (certificate of construction type), US (FCC), Canada (IC) of the various authentication already acquired, and Europe (CE) standards of suitability confirmed. The following summarizes the described items required in the specifications in the Radio Law of each country.

Table-18

項目 Parameter	必要事項 Matters
日本(工事設計認証) Japan (certificate of construction type)	本製品には電波法に基づく工事設計認証を受けた特定無線設備を用いています。
米国(FCC) US (FCC)	<p>This device complies with part 15 of the FCC Rules. Operation is subject to the following two conditions: (1) This device may not cause harmful interference, and (2) this device must accept any interference received, including interference that may cause undesired operation.</p> <p>FCC CAUTION Change or modifications not expressly approved by the party responsible for compliance could void the user's authority to operate the equipment.</p> <p>This transmitter must not be co-located or operated in conjunction with any other antenna or transmitter.</p> <p>Caution Exposure to radio frequency radiation To comply with FCC RF exposure compliance requirements, a separation distance of at least 20 cm must be maintained between the antenna of this device and all persons. This device must not be co-located or operating in conjunction with any other antenna or transmitter.</p>

<p>カナダ (IC) Canada (IC)</p>	<p>This device complies with Industry Canada licence-exempt RSS standard(s). Operation is subject to the following two conditions: (1) this device may not cause interference, and (2) this device must accept any interference, including interference that may cause undesired operation of the device.</p> <p>Le présent appareil est conforme aux CNR d'Industrie Canada applicables aux appareils radio exempts de licence. L'exploitation est autorisée aux deux conditions suivantes : (1) l'appareil ne doit pas produire de brouillage, et (2) l'utilisateur de l'appareil doit accepter tout brouillage radioélectrique subi, même si le brouillage est susceptible d'en compromettre le fonctionnement.</p> <p>To reduce potential radio interference to other users, the antenna type and its gain should be so chosen that the equivalent isotropically radiated power (EIRP) is not more than that required for successful communication.</p> <p>Pour réduire le potentiel d'interférence radioélectrique pour d'autres utilisateurs, le type d'antenne et son gain doivent être choisis pour que la puissance isotrope rayonnée équivalente (PIRE) soit limitée à celle juste requise pour obtenir une bonne communication.</p> <p>To comply with IC RF exposure compliance requirements, this device must not be co-located or operating in conjunction with any other antenna or transmitter.</p> <p>Pour se conformer aux exigences de conformité de la IC, cet appareil ne doit pas être co-localisées ou opérant en conjonction avec une autre antenne ou transmetteur</p>
<p>欧州 (CE) Europe (CE)</p>	<p>None</p>

### 3-3-3. Bluetooth 仕様 BLUETOOTH SPECIFICATION

Table-19

項目 Parameter	仕様 Specification
準拠仕様 Conformity specification	Bluetooth 3.0
パワークラス Power Class	CLASS 2
対応 Profile (AH147AC/BC) Supported Profile (AH147AC/BC)	iAP(iPod Accessory Protocol) <ul style="list-style-type: none"> <li>• iAP1</li> <li>• iAP2</li> </ul>



### 3-3-4. Bluetooth 動作状態説明 BLUETOOTH OPERATING STATE DESCRIPTION

#### 3-3-4-1. BT\_STATUS\_LED

LED の点滅で Bluetooth の動作状態を通知します。

Notify the Bluetooth operating state in flashing LED.

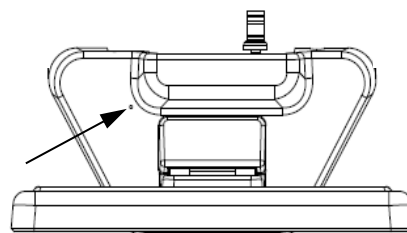

#### ■ Inquiry (通信相手探索)

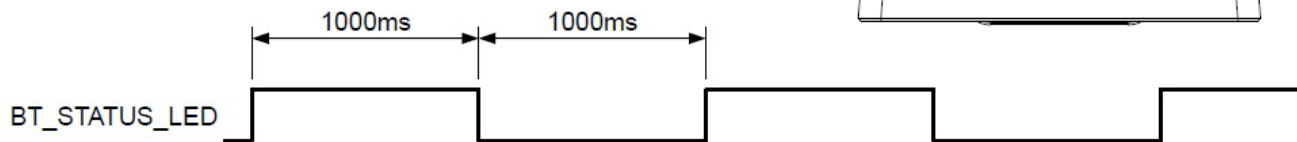

#### ■ Discoverable (通信相手発見待ち)



#### ■ Connectable (通信接続待ち)



#### ■ Pairing (ペアリング)

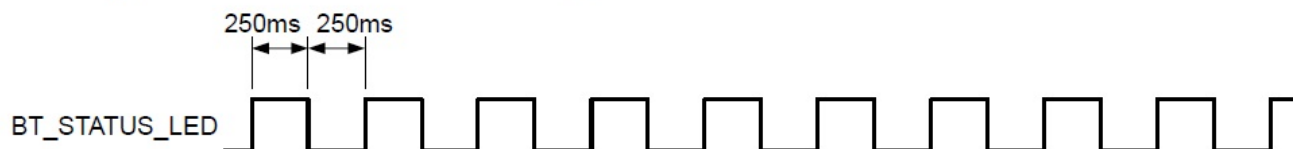

#### ■ Connecting (通信接続判定)

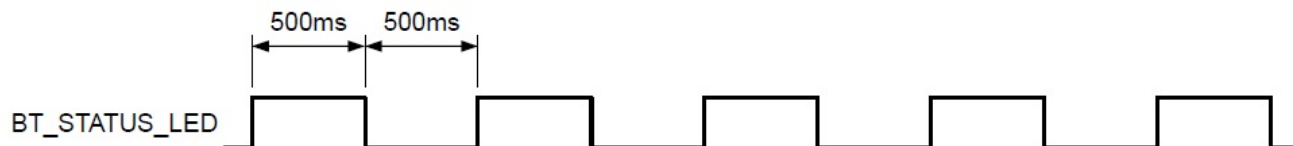

#### ■ iAP(iAP1/ iAP2) Connected (iAP 接続完了)



■ **Disconnecting** (通信切断中)

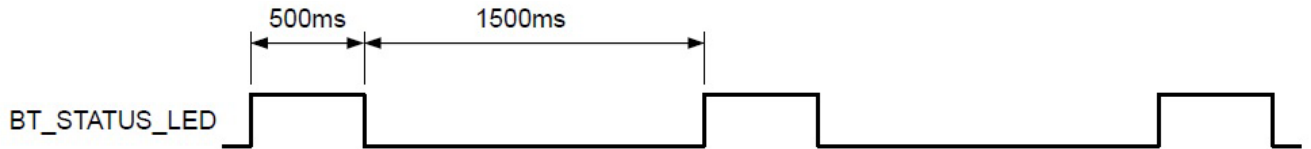

**3-3-4-2. BT\_RENEW\_SW**

RENEW スイッチを押す時間によって下記のように動作します。

スイッチ短押し: Bluetooth 接続/切断

スイッチ長押し: ペ어링情報データベースをクリア

It will work as follows by the time press RENEW switch.

Switch short press: Bluetooth connection / disconnection.

Switch long press: Clear the pairing information database.

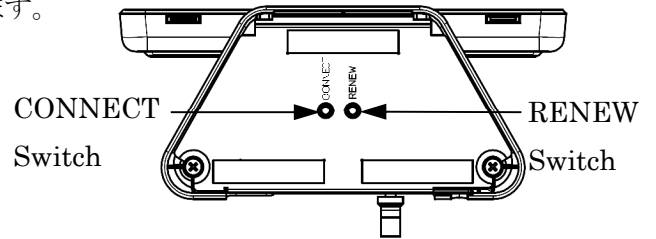

**3-4-3. BT\_CONNECT\_SW**

CONNECT スイッチを押すことで、本製品から最後に接続した iOS 機器へ再接続を開始する信号を送信します。

Pressing CONNECT switch, send a signal to start reconnecting from this module to the last connected iOS device.

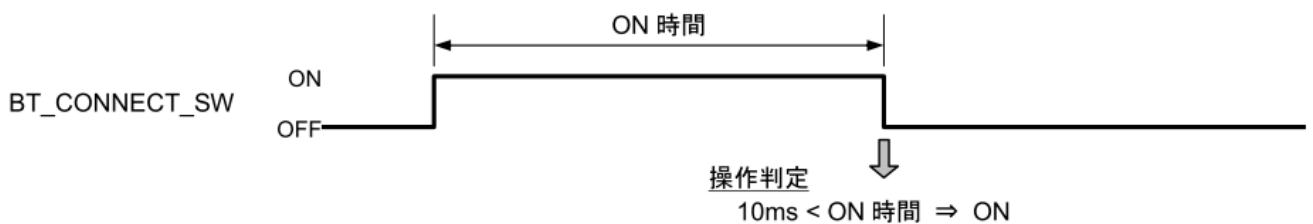

### 3-3-5. iAP Accessory 設定 iAP ACCESSORY SETTINGS

Table-20

Parameter	Specification
Profile Settings	3 ( iAP Enable)
Data Transmission Mode	0 (iAP Data Through Mode)
Autonomous Launch	0 (Disable Autonomous launch)
Accessory Incoming Max Payload Size	400
Accessory name	“Slim design display”
Manufacturer	“Futaba Corporation”
Model Number	“AH147AC” or “AH147BC”
Serial Number	“0000001”~
Firmware version	1. 0. 0
Hardware version	1. 0. 0
Protocol string	“com.futaba.protocol”
Protocol MetadataType	2
Bundle seed ID number	“ASLQTPDR6Q”
Application Bundle ID String	“com.futaba.app”
Accessory RF Certifications	0
Maximum Number of Outstanding Packets	5
Cumulative Acknowledgements	3, 0x03E8

### 3-3-6. セキュリティ仕様 SECURITY SPECIFICATION

Table-21

項目 Parameter	仕様 Specification
固定 PIN Code Fixed PIN Code	0000
セキュリティ設定 Security setting	1

### 3-3-7. ペアリング仕様 PAIRING SPECIFICATION

ペアリング情報データベースは最大 8 台までのペアリング情報が登録可能です。

ペアリング情報には接続履歴が含まれます。接続履歴は、最後に接続した相手が最新となるよう、接続をする度に並び替えを行います。8 台を超えてペアリングを行うと、最も古く接続した相手のペアリング情報を削除し、新しく接続した相手のペアリング情報を追加します。

Max 8 pairing information can be registered in the pairing information database. Pairing information is included in connection history. The connection history is rearranged each time the connection is made so that the last connected party becomes the latest. When more than 8 pairing is performed, the pairing information of the oldest connected party is deleted, and the pairing information of the newly connected opponent is added.

#### 4. コマンド COMMAND

本モジュールは、以下のコマンドを有します。

The followings are all commands of this module.

No.	Command	Byte	1st	2nd	3rd	4th	5th	6th	7th	8th	9th	10th	11th	12th ~
1	BACKSPACE	1	08h											
2	HORIZONTAL TAB	1	09h											
3	LINE FEED	1	0Ah											
4	CARRIAGE RETURN	1	0Dh											
5	GRAPHIC MODE	802	1Bh	20h	<i>Pd ...</i>									
6	SET COUNTRY CODE	3	1Bh	52h	<i>n</i>									
7	DELETE TO END OF LINE	4	1Bh	5Bh	30h	4Bh								
8	MODULE INFORMATION RESPONSE	4	1Bh	5Bh	30h	63h								
9	CLEAR SCREEN	4	1Bh	5Bh	32h	4Ah								
10	HOME POSITION	4	1Bh	5Bh	48h	27h								
11	TURN ON/OFF DISPLAY	4	1Bh	5Bh	<i>n</i>	50h								
12	SPECIFIED POSITION	6	1Bh	5Bh	<i>Py</i>	3Bh	<i>Px</i>	48h						
13	CURSOR MODE	6	1Bh	5Ch	3Fh	4Ch	43h	<i>Ps</i>						
14	LCD CONTRAST & VFD BRIGHTNESS	7	1Bh	5Ch	3Fh	4Ch	44h	<i>Pc</i>	<i>Pb</i>					
15	USER DEFINED CHARACTERS	27 or 44	1Bh	5Ch	3Fh	4Ch	57h	<i>Pf</i>	3Bh	<i>Pn</i>	3Bh	<i>Pc</i>	3Bh	<i>Pd ...</i>

Table - 22

## 4-1. コマンド詳細 FUNCTION OF COMMANDS

本製品の制御コマンドは以下の通りです。Following is the details of each command.

### 4-1-1. BACKSPACE

Code: 08h

MSB

LSB

Table - 23

Code	Byte	Bit7	Bit6	Bit5	Bit4	Bit3	Bit2	Bit1	Bit0	Note
08h	1st	0	0	0	0	1	0	0	0	

Function: Moves the cursor one character position to the left.

When the cursor is at the left end of the lower line, it is moved to the right end of the upper line. When it is at the left end of the upper line, it is moved to the right end of the lower line.

機能: カーソルを1文字左に移動します。

カーソルが下段の左端にある場合、上段の右端に移動します。上段の左端にある場合は、下段の右端に移動します。

[Example]

//Before command is sent

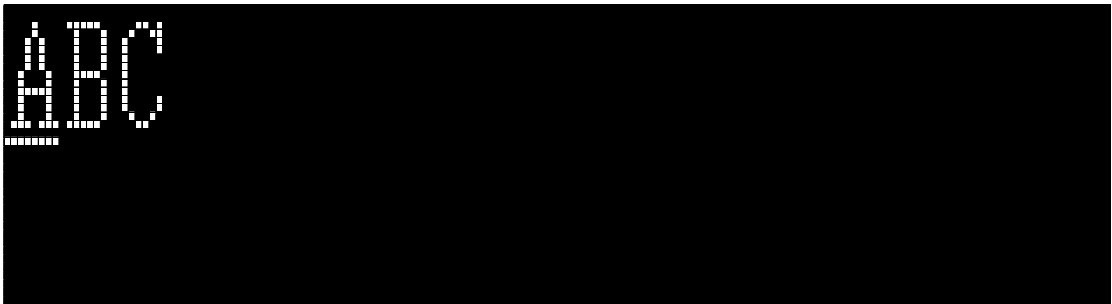

//Send command

Send( 08h );

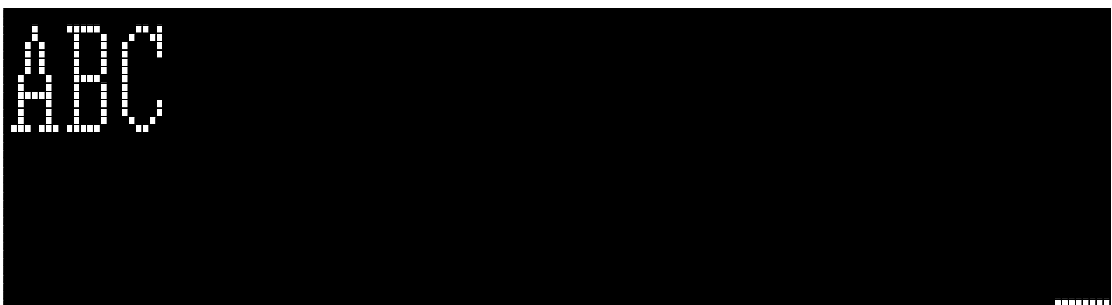

## 4-1-2. HORIZONTAL TAB

Code: 09h

MSB

LSB

Table - 24

Code	Byte	Bit7	Bit6	Bit5	Bit4	Bit3	Bit2	Bit1	Bit0	Note
09h	1st	0	0	0	0	1	0	0	1	

Function: Moves the cursor one character position to the right.

When the cursor is at the right end of the upper line, it is moved to the left end of the lower line. When it is at the right end of the lower line, it is moved to the left end of the upper line.

機能: 右にカーソルを1文字位置を移動します。

カーソルが下段の右端にある場合、上段の左端に移動します。上段の右端にある場合は、下段の左端に移動します。

[Example]

//Before command is sent

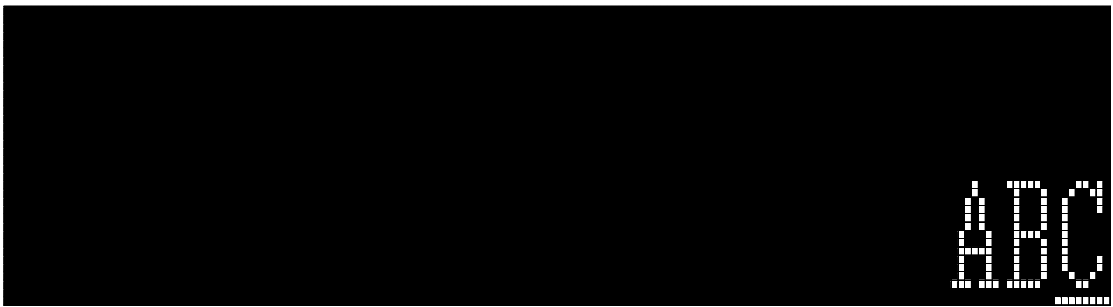

//Send command

Send( 09h );

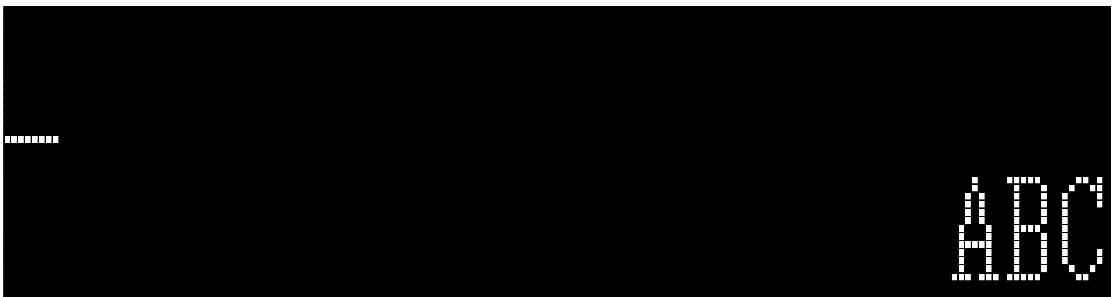

### 4-1-3. LINE FEED

Code: 0Ah

MSB

LSB

Table - 25

Code	Byte	Bit7	Bit6	Bit5	Bit4	Bit3	Bit2	Bit1	Bit0	Note
0Ah	1st	0	0	0	0	1	0	1	0	

Function: Moves the cursor down one line

If the cursor is in the lower line, the cursor moves to the same column on the upper.

機能: 1段下にカーソルを移動します。桁は同じ位置になります。カーソルが下段にあるとき、上段に移動します。

[Example]

//Before command is sent

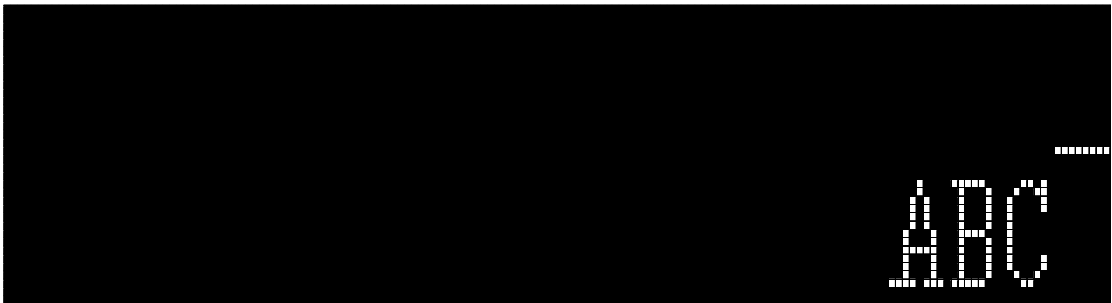

//Send command

Send( 0Ah );

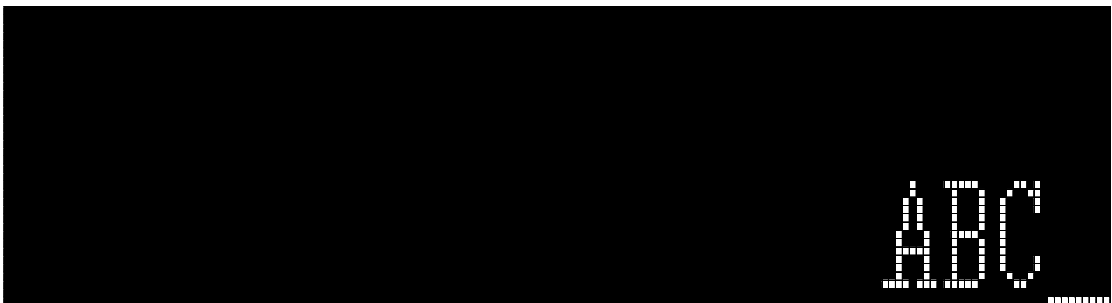

#### 4-1-4. CARRIAGE RETURN

Code: 0Dh

MSB

LSB

Table - 26

Code	Byte	Bit7	Bit6	Bit5	Bit4	Bit3	Bit2	Bit1	Bit0	Note
0Dh	1st	0	0	0	0	1	1	0	1	

Function: Moves the cursor to the left-most position on current line.

機能: カーソルを現在ある段の左端に移動させます。

[Example]

//Before command is sent

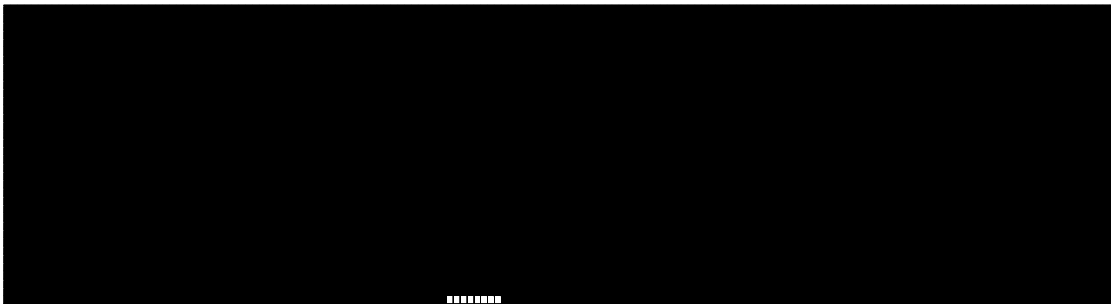

//Send command

Send( 0Dh );

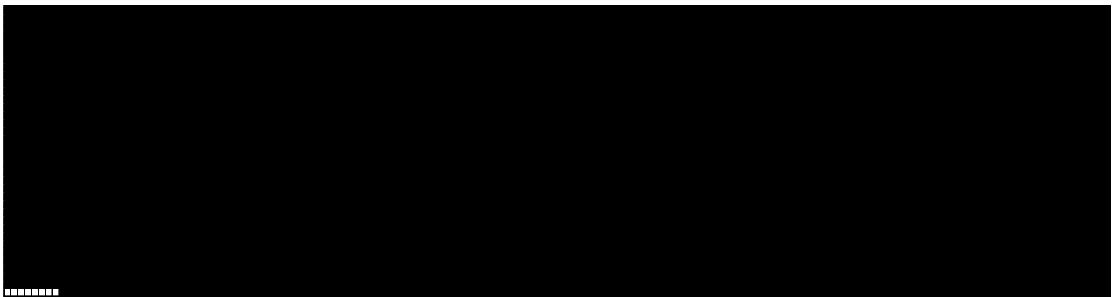



### 4-1-5. GRAPHIC MODE

Code: 1Bh, 20h, Pd...Pd

MSB

LSB

Table - 27

Code	Byte	Bit7	Bit6	Bit5	Bit4	Bit3	Bit2	Bit1	Bit0	Note
1Bh	1st	0	0	0	1	1	0	1	1	
20h	2nd	0	0	1	0	0	0	0	0	
Pd...Pd	3rd~	Pd	Pd	Pd	Pd	Pd	Pd	Pd	Pd	Pd1 ... Pd800

Function: Graphic display mode. The data will be start at (0,0) of display position.

機能: イメージデータをディスプレイに表示します。(0,0)の位置から描画します。

MSB	LSB	Pd1	Pd2	Pd3	Pd4	Pd5	5 × 160 byte	Pd781	Pd782	Pd783	Pd784	Pd785
		Pd6	Pd7	Pd8	Pd9	Pd10		Pd786	Pd787	Pd788	Pd789	Pd790
		Pd11	Pd12	Pd13	Pd14	Pd15		Pd788	Pd789	Pd790	Pd791	Pd792
		Pd16	Pd17	Pd18	Pd19	Pd20		Pd791	Pd792	Pd793	Pd794	Pd795
		•	•	•	•	•		Pd796	Pd797	Pd798	Pd799	Pd800

#### 4-1-6. SET COUNTRY CODE

Code: 1Bh, 52h, n

Code	Byte	MSB				LSB				Note
		Bit7	Bit6	Bit5	Bit4	Bit3	Bit2	Bit1	Bit0	
1Bh	1st	0	0	0	1	1	0	1	1	
52h	2nd	0	1	0	1	0	0	1	0	
n	3rd	0	0	n	n	n	n	n	n	00h ≤ n ≤ 0Dh, 30h ≤ n ≤ 3Dh

Table - 28

Function : Select international font set. (Please refer international Font Set Table.).00h ≤ n ≤ 0Dh. The default setting is 00h(USA) and 30h(PC437).

機能： フォントテーブルを00(h) ≤ n ≤ 0D(h), 30(h) ≤ n ≤ 3D(h)から選択します。後述のフォントテーブルをご参照ください。電源投入時の初期設定は、00h(USA)、30h(PC437)です。

00h～0Dh: Character code 20h-7Fh

30h～3Dh: Character code 80h-FFh

Table -29

n	Country Code (20h – 7Fh)	n	Country Code (80h - FFh)
00h	USA – default	30h	PC437 (USA: Standard Europe) – default
01h	France	31h	Katakana
02h	Germany	32h	PC850 (Multilingual)
03h	Great Britain	33h	PC860 (Portuguese)
04h	Denmark 1	34h	PC863(Canadian-French)
05h	Sweden	35h	Page 5 [PC865 (Norwegian)]
06h	Italy	36h	WPC1252
07h	Spain 1	37h	PC866 [Cyrillic #2]
08h	Japan	38h	PC852 [Latin 2]
09h	Norway	39h	Page 19 [PC858]
0Ah	Denmark 2	3Ah	Japanese font(shift JIS)
0Bh	Spain 2	3Bh	Simplified Chinese(GB2312)
0Ch	Latin America	3Ch	Traditional Chinese(Big5)
0Dh	Korea	3Dh	Hangul(KSC5601)

#### 4-1-7. DELETE TO END OF LINE

Code: 1Bh, 5Bh, 30h, 4Bh

MSB

LSB

Table - 30

Code	Byte	Bit7	Bit6	Bit5	Bit4	Bit3	Bit2	Bit1	Bit0	Note
1Bh	1st	0	0	0	1	1	0	1	1	
5Bh	2nd	0	1	0	1	1	0	1	1	
30h	3rd	0	0	1	1	0	0	0	0	
4Bh	4th	0	1	0	0	1	0	1	1	

Function: Clears the line containing the cursor.

After this command is executed, the cursor moves to the left-most position on the current line.

機能: カーソルのある段を消去します。

このコマンドを実行した後、カーソルは左端へ移動します。

[Example]

//Before command is sent



```

ABCDEFGHIJKLMNOPQRSTUVWXYZ
UVWXYZ1234567890+-*/
    
```

//Send command

`send(1Bh, 5Bh, 30h, 4Bh );`



```

ABCDEFGHIJKLMNOPQRSTUVWXYZ
.....
    
```

#### 4-1-8. MODULE INFORMATION RESPONSE

Code: 1Bh, 5Bh, 30h, 63h

Code	Byte	MSB				LSB				Note
		Bit7	Bit6	Bit5	Bit4	Bit3	Bit2	Bit1	Bit0	
1Bh	1st	0	0	0	1	1	0	1	1	
5Bh	2nd	0	1	0	1	1	0	1	1	
30h	3rd	0	0	1	1	0	0	0	0	
63h	4th	0	1	0	1	0	0	0	0	

Table - 31

Function: Module information response command.

The data send from this module is the below.

機能: モジュール情報をホストに送信するコマンドです。

本製品からホストに送信するデータは以下になります。

Response data
4Ch, 43h, 44h, 5Fh, 47h, 50h, 5Fh, 31h, 36h, 30h, 78h , 34h, 30h (LCD_GP_160x40)

Table -32

#### 4-1-9. CLEAR SCREEN

Code: 1Bh, 5Bh, 32h, 4Ah

MSB

LSB

Table - 33

Code	Byte	Bit7	Bit6	Bit5	Bit4	Bit3	Bit2	Bit1	Bit0	Note
1Bh	1st	0	0	0	1	1	0	1	1	
5Bh	2nd	0	1	0	1	1	0	1	1	
32h	3rd	0	0	1	1	0	0	1	0	
4Ah	4th	0	1	0	0	1	0	1	0	

Function: Clears all displayed characters.

After this command is executed, the cursor moves to the home position.

機能: ディスプレイされている文字を全消去します。

このコマンドを実行した後、カーソルはホームポジションへ移動します。

[Example]

//Before command is sent



//Send command

Send(1Bh, 5Bh, 32h, 4Ah);

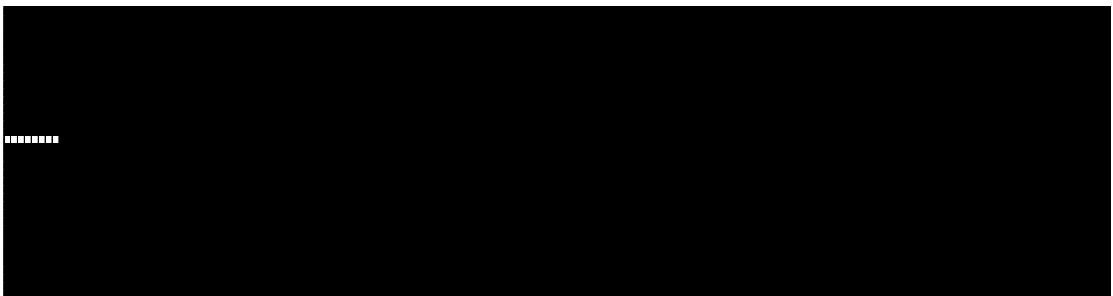

#### 4-1-10. HOME POSITION

Code: 1Bh, 5Bh, 48h, 27h

MSB

LSB

Table - 34

Code	Byte	Bit7	Bit6	Bit5	Bit4	Bit3	Bit2	Bit1	Bit0	Note
1Bh	1st	0	0	0	1	1	0	1	1	
5Bh	2nd	0	1	0	1	1	0	1	1	
48h	3rd	0	1	0	0	1	0	0	0	
27h	4th	0	0	1	0	0	1	1	1	

Function: Moves the cursor to the left-most position on the upper line (home position).

The home position indicates the first column of the upper line.

機能: ホームポジションの位置にカーソルを移動します。

ホームポジションは、上段の最初の桁を示します。

[Example]

//Before command is sent

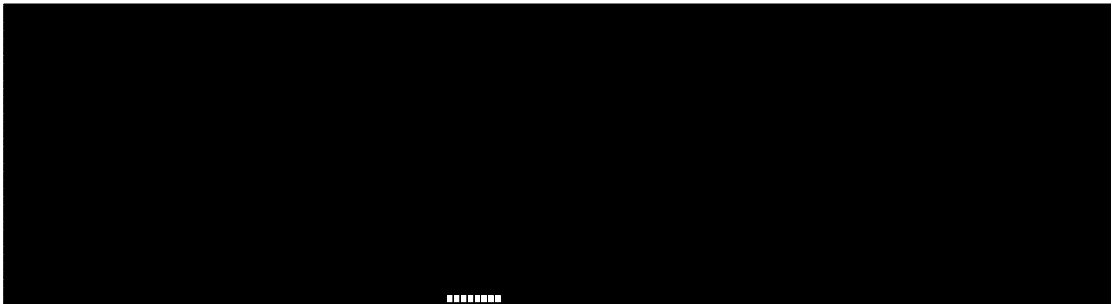

//Send command

Send(1Bh, 5Bh, 48h, 27h );

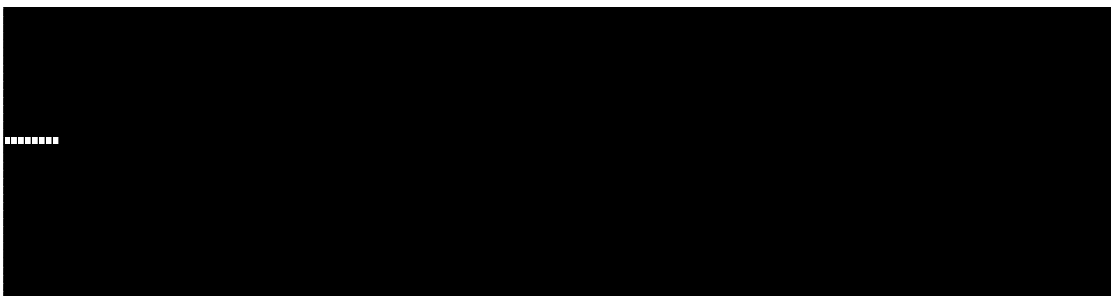

#### 4-1-11. TURN ON/OFF DISPLAY

Code: 1Bh, 5Bh, n, 50h

Code	Byte	MSB					LSB			Note
		Bit7	Bit6	Bit5	Bit4	Bit3	Bit2	Bit1	Bit0	
1Bh	1st	0	0	0	1	1	0	1	1	
5Bh	2nd	0	1	0	1	1	0	1	1	
n	3rd	0	0	0	0	0	0	0	n	$00h \leq n \leq 01h.$
50h	4th	0	1	0	1	0	0	0	0	

3rd byte	Bit0	Note
	0	Display OFF
	1	Display ON (Default)

Function: Back light power ON/OFF control command. If n=0, Back light power is OFF, if n=1, Back light power is ON. The state of display power ON/OFF is valid until next command of power or soft reset.

機能: LCDのバックライトON/OFFを制御するコマンドです。n = 0 でバックライトはOFF、n = 1 でバックライトはONとなります。ON/OFFの状態は再度このコマンドを送信するか、初期化されるまで続きます。

#### 4-1-12. SPECIFIED POSITION

Code: 1Bh, 5Bh, Py, 3Bh, Px, 48h

Code	Byte	MSB					LSB				Note
		Bit7	Bit6	Bit5	Bit4	Bit3	Bit2	Bit1	Bit0		
1Bh	1st	0	0	0	1	1	0	1	1		
5Bh	2nd	0	1	0	1	1	0	1	1		
Py	3rd	0	0	0	0	0	0	Py	Py	$01h \leq Py(\text{column}) \leq 02h$ .	
3Bh	4th	0	0	1	1	1	0	1	1		
Px	5th	0	0	0	Px	Px	Px	Px	Px	$01h \leq Px(\text{row}) \leq 14h$ .	
48h	6th	0	1	0	0	1	0	0	0		

2nd byte	Bit2	Bit1	Bit0	Start write on top position
	0	0	1	01h
	0	1	0	02h

5th byte	Bit7	Bit6	Bit5	Bit4	Bit3	Bit2	Bit1	Bit0	Start write on left position
	0	0	0	0	0	0	0	1	01h
	0	0	0	0	0	0	1	0	02h
	:								
	0	0	0	1	0	0	1	1	13h
	0	0	0	1	0	1	0	0	14h

Function: Moves the cursor to the x th position on the y th line.

If the command specifies a value for n or m that exceeds the range, this command is ignored, and the cursor is not moved.

機能: Py段のPx桁目の位置にカーソルを移動します。

コマンドが範囲を超えたPy、Pxの値を指定している場合、このコマンドは無視されカーソルは移動しません。



### 4-1-13. CURSOR MODE

Code: 1Bh, 5Ch, 3F, 4Ch, 43, Ps

Code	Byte	MSB						LSB		Note
		Bit7	Bit6	Bit5	Bit4	Bit3	Bit2	Bit1	Bit0	
1Bh	1st	0	0	0	1	1	0	1	1	
5Ch	2nd	0	1	0	1	1	1	0	0	
3Fh	3rd	0	0	1	1	1	1	1	1	
4Ch	4th	0	1	0	0	1	0	1	1	
43h	5th	0	1	0	0	0	0	1	1	
Ps	6th	0	0	0	0	0	0	Ps	Ps	$00h \leq Ps \leq 02h.$

6th byte	Bit1	Bit0	Start write on top position
0	0	0	Ps = 00h: Cursor OFF (Default)
0	1	1	Ps = 01h: Cursor blink
1	0	0	Ps = 02h: Cursor ON

Function: Selects or cancels the cursor display.

When Ps = 1, the cursor blinks. When Ps = 2, the cursor will continue to light up. Cursor at Ps = 0 will turn off.

機能: カーソルの表示・非表示を設定します。

Ps = 1のとき、カーソルは点滅します。Ps = 2のとき、カーソルは点灯し続けます。Ps = 0でカーソルは消灯します。

#### 4-1-14. LCD CONTRAST & VFD BRIGHTNESS

Code: 1Bh, 5Ch, 3Fh, 4Ch, 44h, Pc, Pb

Code	Byte	MSB					LSB				Note
		Bit7	Bit6	Bit5	Bit4	Bit3	Bit2	Bit1	Bit0		
1Bh	1st	0	0	0	1	1	0	1	1		
5Ch	2nd	0	1	0	1	1	1	0	0		
3Fh	3rd	0	0	1	1	1	1	1	1		
4Ch	4th	0	1	0	0	1	1	0	0		
44h	5th	0	1	0	0	0	1	0	0		
Pc	6th	0	0	0	0	0	Pc	Pc	Pc	$00h \leq Pc \leq 06h$	
Pb	7th	0	0	0	0	0	0	Pb	Pb	$00h \leq Pb \leq 03h$ ※	

Function: LCD contrast and VFD brightness adjustment.

Pc set up the LCD contrast. (Table-39)

Pb set up the VFD brightness. (Table-40)

※This module doesn't set up VFD brightness. Please set the Pb = 03h.

機能: LCDのコントラストとVFDの輝度を設定します。

LCDのコントラストは、Pcの値で設定します。(Table-39)

VFDの輝度は、Pbの値で設定します。(Table-40)

※本品種ではVFDの輝度設定を使用しないため、Pbの値はPb=03hと設定してください。

Table - 39

Pc	LCD Contrast
00h	-3
01h	-2
02h	-1
03h	0 (Default)
04h	+1
05h	+2
06h	+3

Table - 40

Pb	VFD Brightness (%)
00h	20
01h	40
02h	60
03h	100 (Default) ※

#### 4-1-15. USER DEFINED CHARACTERS

Code: 1Bh, 5Ch, 3Fh, 4Ch, 57h, Pf, 3Bh, Pn, 3Bh, Pc, 3Bh, Pd ...

Table - 41

Code	Byte	MSB					LSB				Note
		Bit7	Bit6	Bit5	Bit4	Bit3	Bit2	Bit1	Bit0		
1Bh	1st	0	0	0	1	1	0	1	1		
5Ch	2nd	0	1	0	1	1	1	0	0		
3Fh	3rd	0	0	1	1	1	1	1	1		
4Ch	4th	0	1	0	0	1	1	0	0		
57h	5th	0	1	0	1	0	1	1	1		
Pf	6th	0	0	0	0	0	0	Pf	Pf	01h ≤ Pf ≤ 02h.	
3Bh	7th	0	0	1	1	1	0	1	1		
Pn	8th	0	0	0	Pn	Pn	Pn	Pn	Pn	00h ≤ Pn ≤ 1Fh (Pf = 01h) 00h ≤ Pn ≤ 0Fh (Pf = 02h)	
3Bh	9th	0	0	1	1	1	0	1	1		
Pc	10th	Pc	Pc	Pc	Pc	Pc	Pc	Pc	Pc	20h ≤ Pc ≤ 7Fh (Pf = 01h)※ 80 00h ≤ Pc ≤ FF FFh (Pf = 02h)	
3Bh	11th	0	0	1	1	1	0	1	1		
Pd	12th~	Pd	Pd	Pd	Pd	Pd	Pd	Pd	Pd	16 byte or 32byte	

Function: Defines user-defined characters.

User-defined character that was defined will be displayed by the character code of the Pc. User-defined character font data to be secured on the RAM, are cleared by power-off. The maximum number of characters that can be registered in each font size is below. If the user-defined character is already registered in the specified font number, to release that character and make a new user-defined character.

Pf = 01h: One-byte character 8×16 → Maximum 32 characters

Pf = 02h: Two-byte character 16×16 → Maximum 16 characters

•Font size (Pf = 1), if you specify the 00h to the character code(Pc), and then release the user-defined character that is registered with the given font number. Font size (Pf = 2), if you specify the 00h 00h to the character code(Pc), and then release the user-defined character that is registered with the given font number.

Pf = 1 (01h) : 1Bh, 5Ch, 3Fh, 4Ch, 57h, Pf, 3Bh, Pn, 3Bh, 00h, 3Bh

Pf = 2 (02h) : 1Bh, 5Ch, 3Fh, 4Ch, 57h, Pf, 3Bh, Pn, 3Bh, 00h, 00h, 3Bh

機能: 外字を定義します。

定義した外字は Pc の文字コードにより表示されます。外字フォントデータは RAM 上に確保されるため、電源遮断により消去されます。各フォントサイズで登録できる最大の文字数は以下となります。指定されたフォント番号に既に外字が登録されている場合、登録されている外字を解除し新たに外字登録を行います。

Pf = 1(01H) : 半角 8×16 最大 32 文字

Pf = 2(02H) : 全角 16×16 最大 16 文字

•文字コード(Pc)に 00h (Pf = 1) 指定した場合、指定されたフォント番号に登録されている外字を解除します。

Pf = 1 (01h) : 1Bh, 5Ch, 3Fh, 4Ch, 57h, Pf, 3Bh, Pn, 3Bh, 00h, 3Bh

Pf = 2 (02h) : 1Bh, 5Ch, 3Fh, 4Ch, 57h, Pf, 3Bh, Pn, 3Bh, 00h, 00h, 3Bh

<i>Pf</i> : Font size フォントサイズ	Pf = 01h : One-byte character 8×16 dot Pf = 02h : Two-byte character 16×16 dot
<i>Pn</i> : Font number フォント番号	00h ≤ Pn ≤ 1Fh (Pf = 01h) 00h ≤ Pn ≤ 0Fh (Pf = 02h)
<i>Pc</i> : Character code 文字コード	20h ≤ Pc ≤ 7Fh (Pf = 01h) ※4-1-12. SET COUNTRY CODEが3A(shiftJIS)の場合、以下の範囲が追加されます。 A0h ≤ Pc ≤ DFh (Pf = 01h) 80 00h ≤ Pc ≤ FF FFh (Pf = 02h)
<i>Pd</i> : Font data フォントデータ	16 byte ( <i>Pf</i> = 01h) 32 byte ( <i>Pf</i> = 02h)

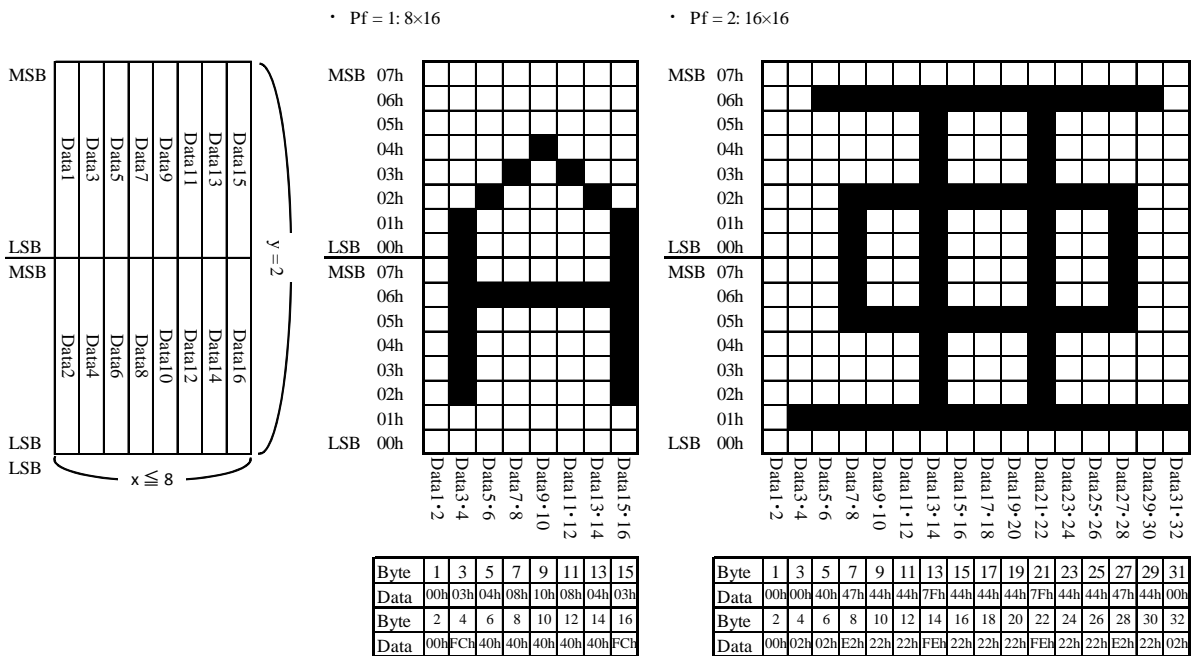

## 5. コネクタ接続 CONECTER CONNECTION

### 5-1. RS232C TYPE (AH147AA/BA)

本体 CN1 : HEC3650-018010 EIAJ-2 or equivalent

CN2 : DSB5-09M1-KNR0-02 D-SUB 9pin male connector or equivalent

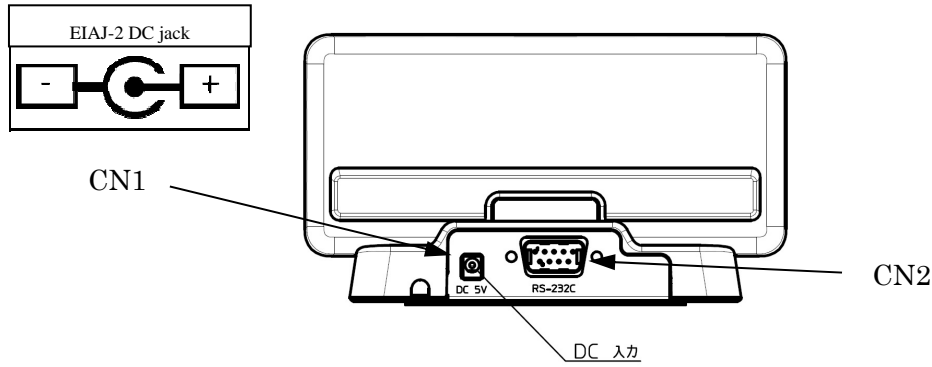

CN2 PIN 配置

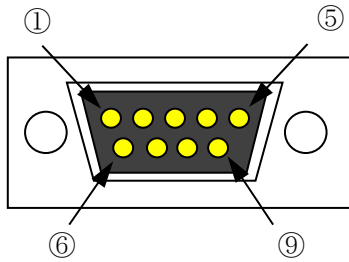

ピン番号 PIN NO.	信号名 Signal Name
1	—
2	RxD
3	TxD
4	—
5	GND
6	—
7	RTS
8	CTS
9	—

## 5-2. USB TYPE (AH147AB/BB)

本体 CN1 : UX60SC-MB-5ST USB Mini-B female connector or equivalent

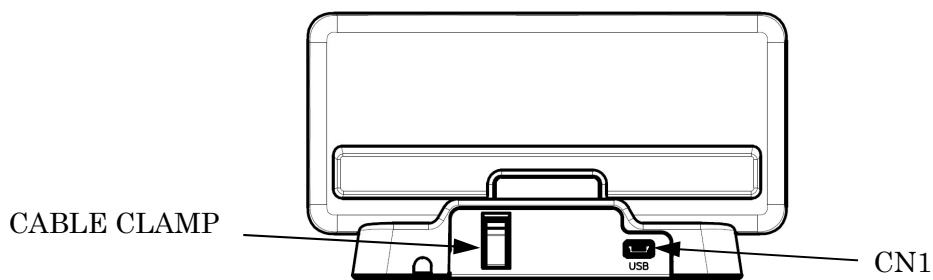

CN1 PIN 配置

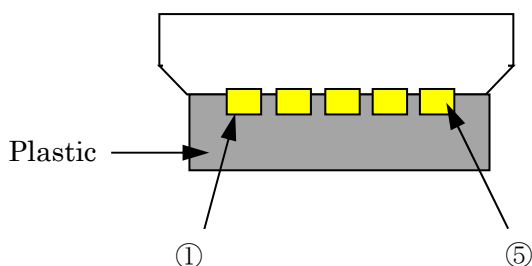

ピン番号 PIN NO.	信号名 Signal Name
1	Vcc (Vbus)
2	D-
3	D+
4	NC
5	GND

## CABLE SPECIFICATION

線径 (Vbus,GND) : AWG24  
 線径 (D+,D-) : AWG28  
 色 : 白と黒の2種類  
 MINIBコネクタ: レフトアングル  
 TYPEAコネクタ: ストレート

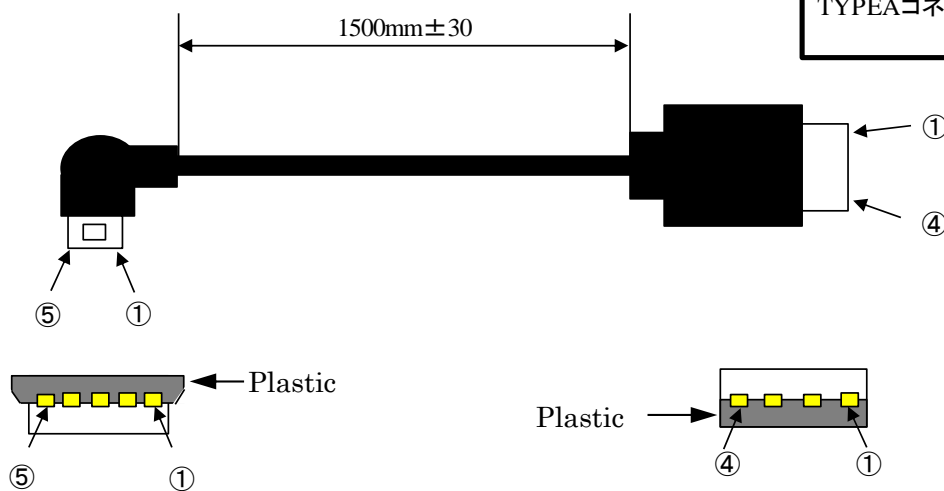

USB Mini-B		USB Type A	
PIN no.	Signal name	PIN no.	Signal name
1	Vcc(Vbus)	1	Vcc(Vbus)
2	D-	2	D-
3	D+	3	D+
4	NC	4	GND
5	GND	SEHLL	FGND
SHELL	FGND		

### 5-3. BLUETOOTH IAP TYPE (AH147AC/BC)

本体 CN1 : UX60SC-MB-5ST USB Mini-B female connector or equivalent

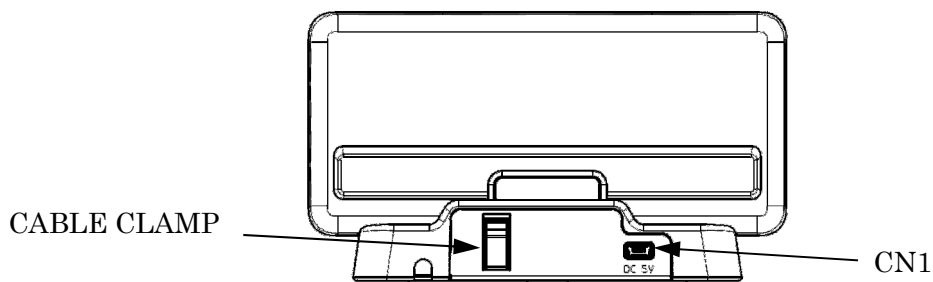

CN1 PIN 配置

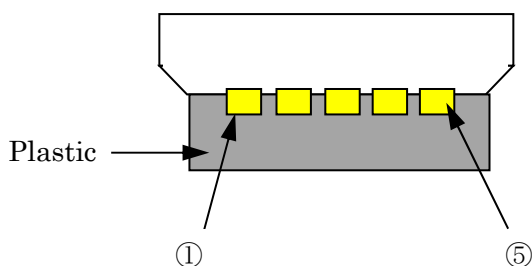

ピン番号 PIN NO.	信号名 SIGNAL NAME
1	Vcc (Vbus)
2	NC (D-)
3	NC (D+)
4	NC
5	GND

### CABLE SPECIFICATION

線径 (Vbus,GND) : AWG24  
 線径 (D+,D-) : AWG28  
 色 : 白と黒の2種類  
 MINIBコネクタ: レフトアングル  
 TYPEAコネクタ: ストレート

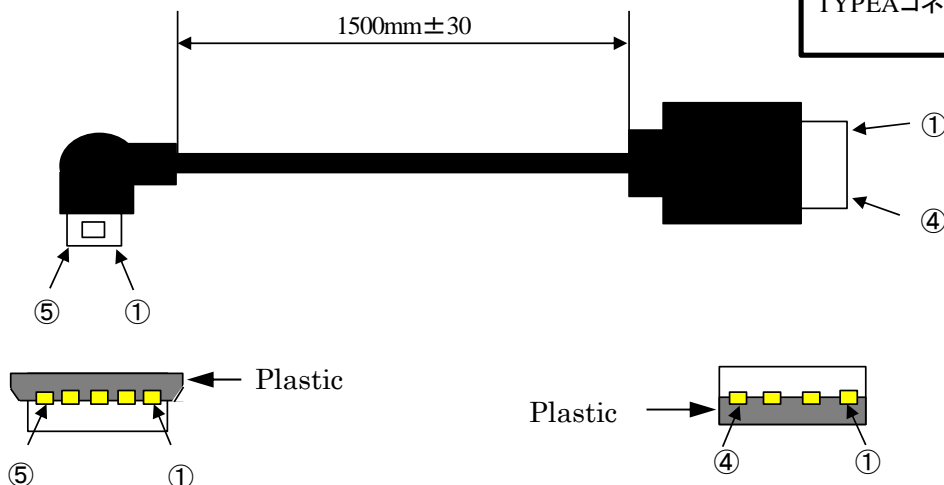

USB Mini-B		USB Type A	
PIN no.	Signal name	PIN no.	Signal name
1	Vcc(Vbus)	1	Vcc(Vbus)
2	D-	2	D-
3	D+	3	D+
4	NC	4	GND
5	GND	SEHLL	FGND
SHELL	FGND		

# Outer Dimensions

FIGURE-1

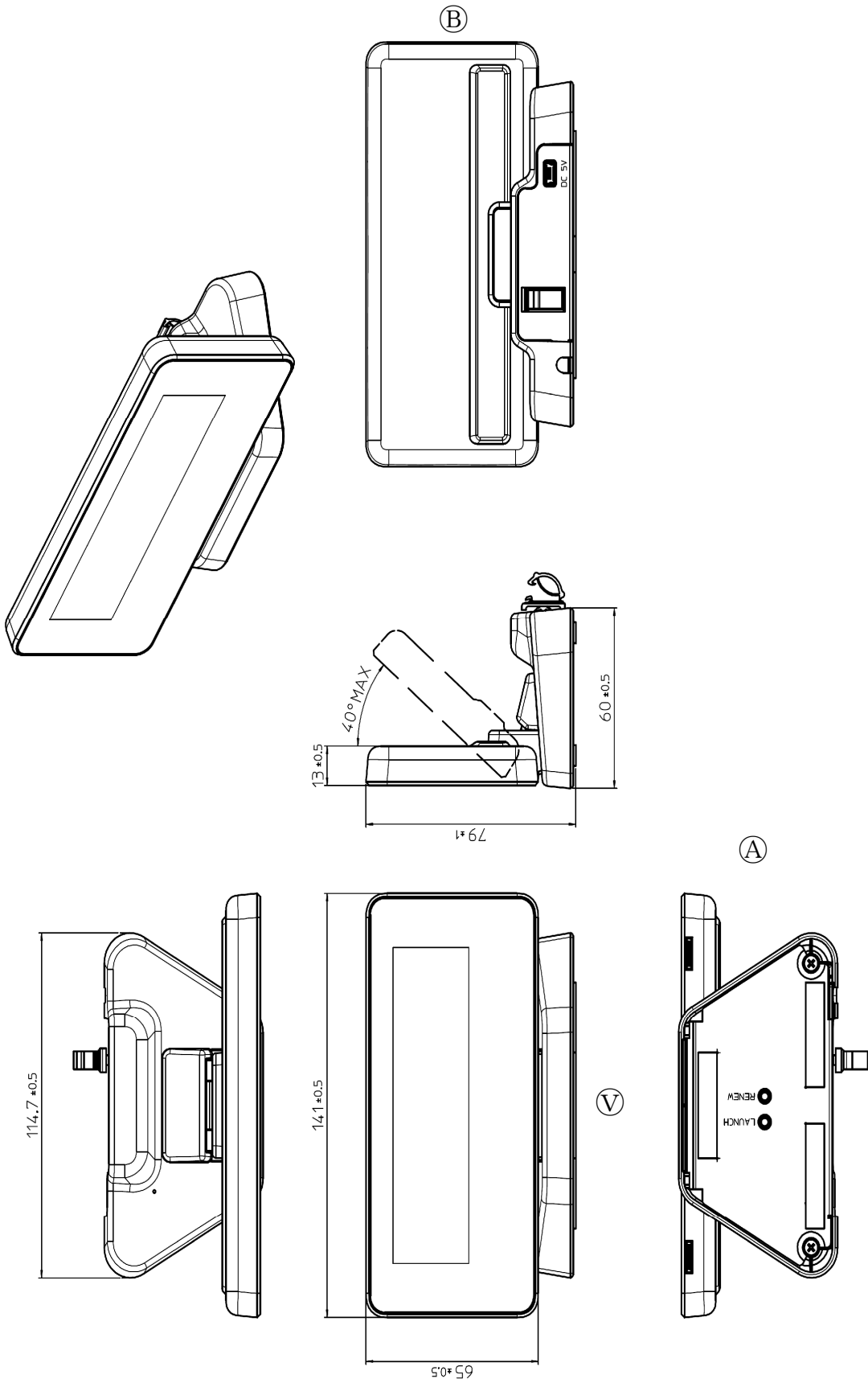



## Outer Dimensions

FIGURE-2

### RS232C TYPE (AH147AA/BA)

Ⓐ

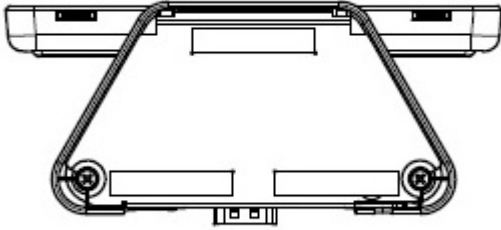

Ⓑ

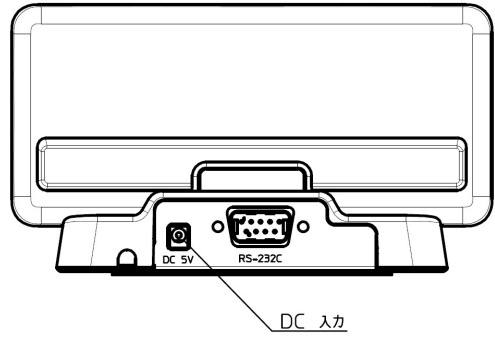

### USB TYPE (AH147AB/BB)

Ⓐ

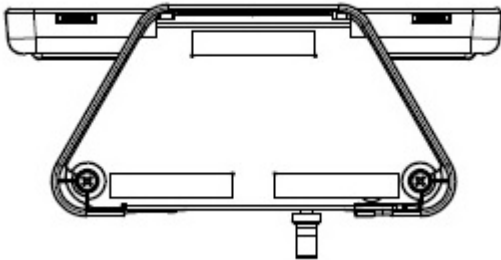

Ⓑ

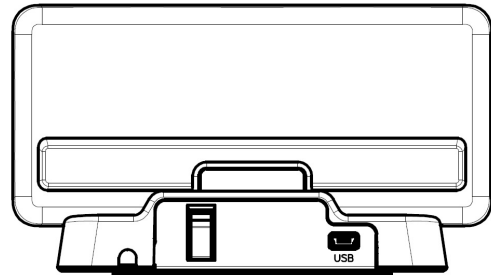

### BLUETOOTH (IAP) TYPE (AH147AC/BC)

Ⓐ

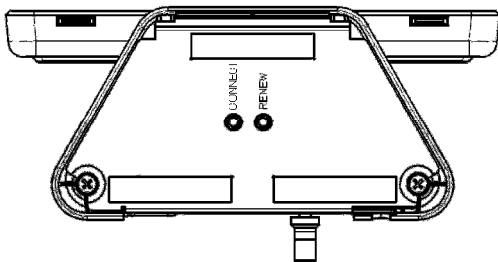

Ⓑ

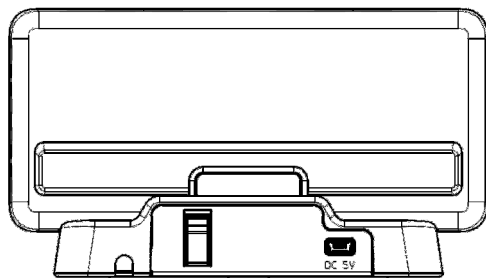

RS232C Type (AH147AA/BA) Block Diagram

FIGURE-3

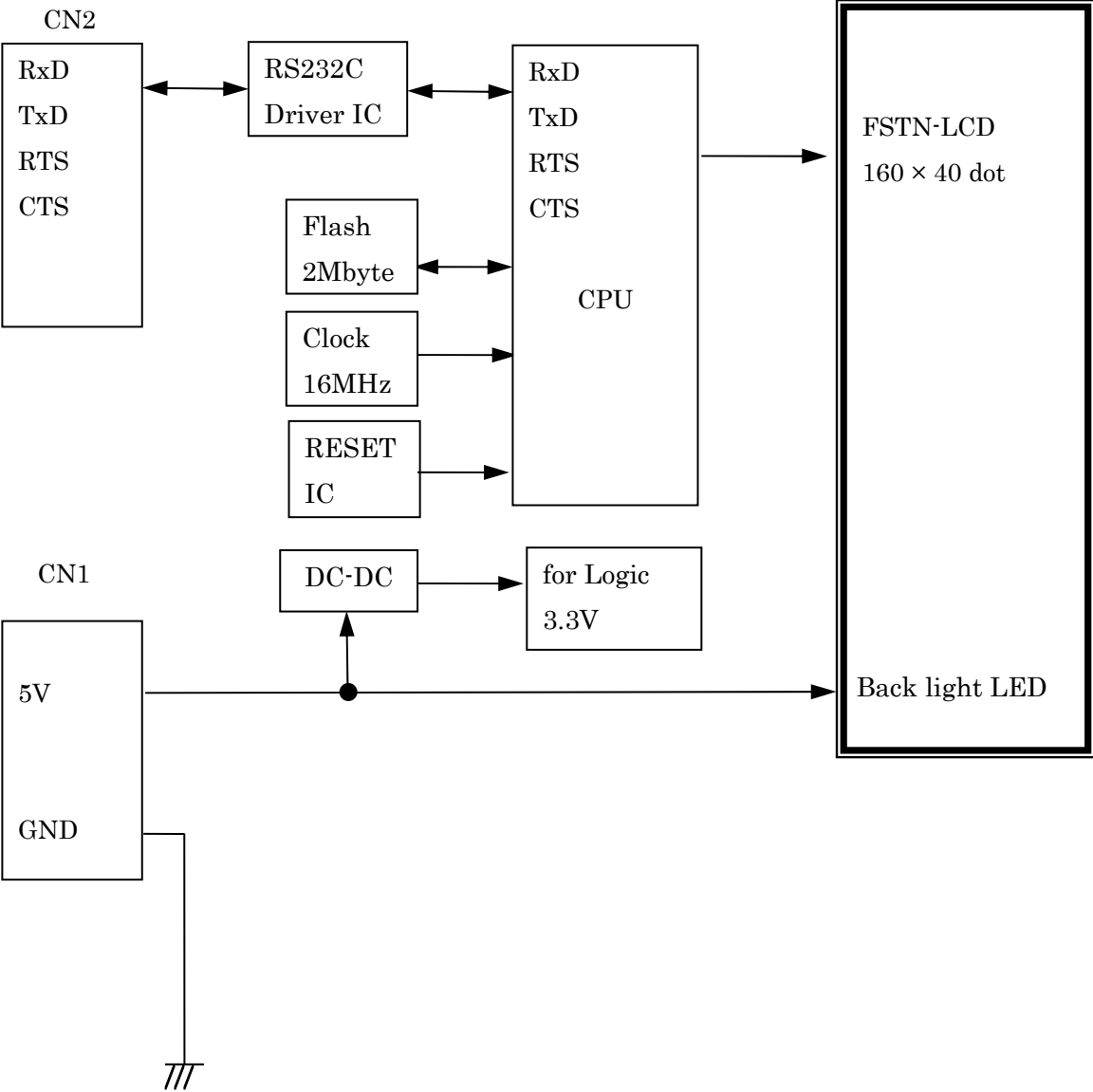

# USB Type (AH147AB/BB) Block Diagram

FIGURE-4

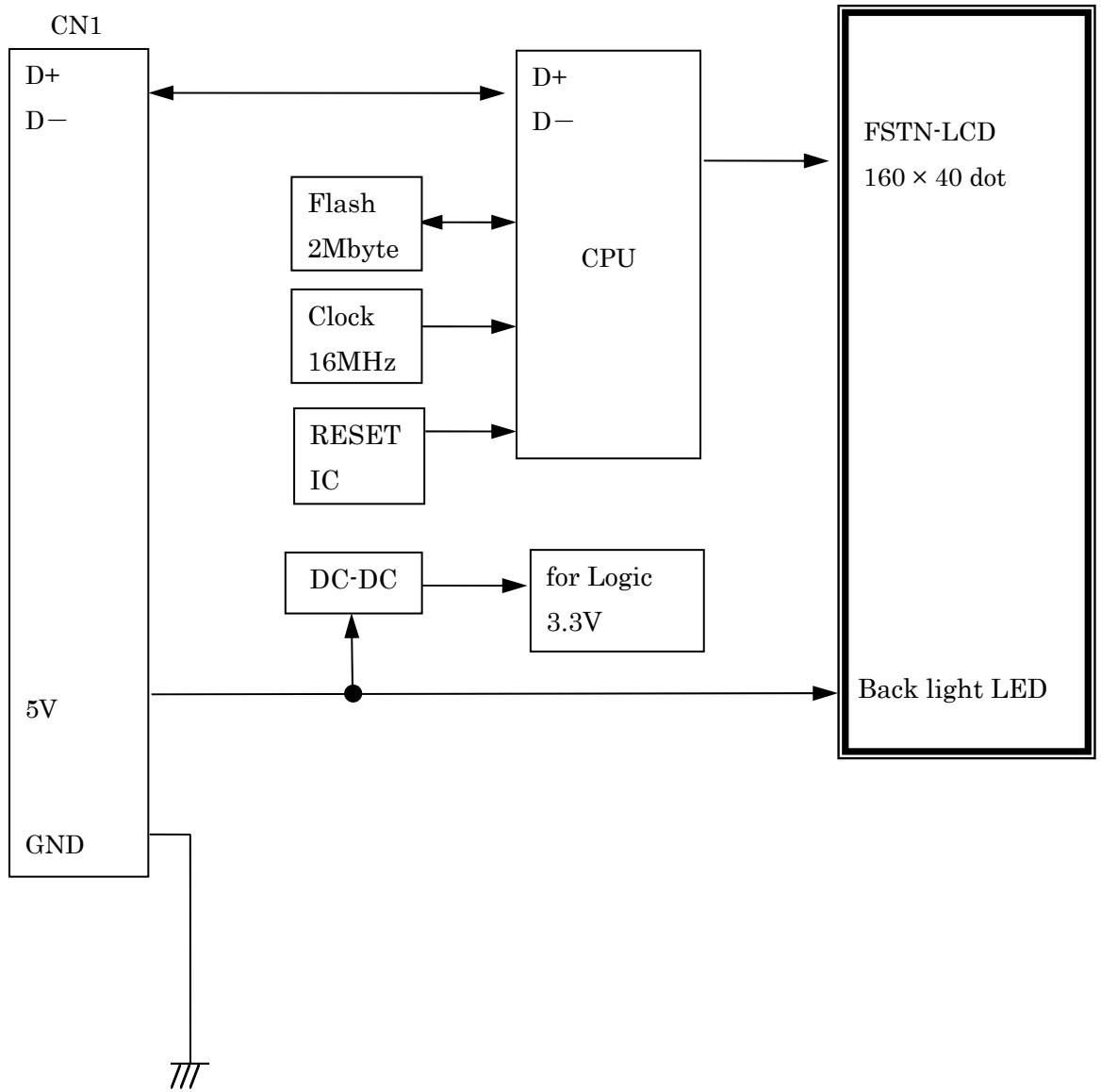

BLUETOOTH(iAP) Type (AH147AC/BC) Block Diagram

FIGURE-5

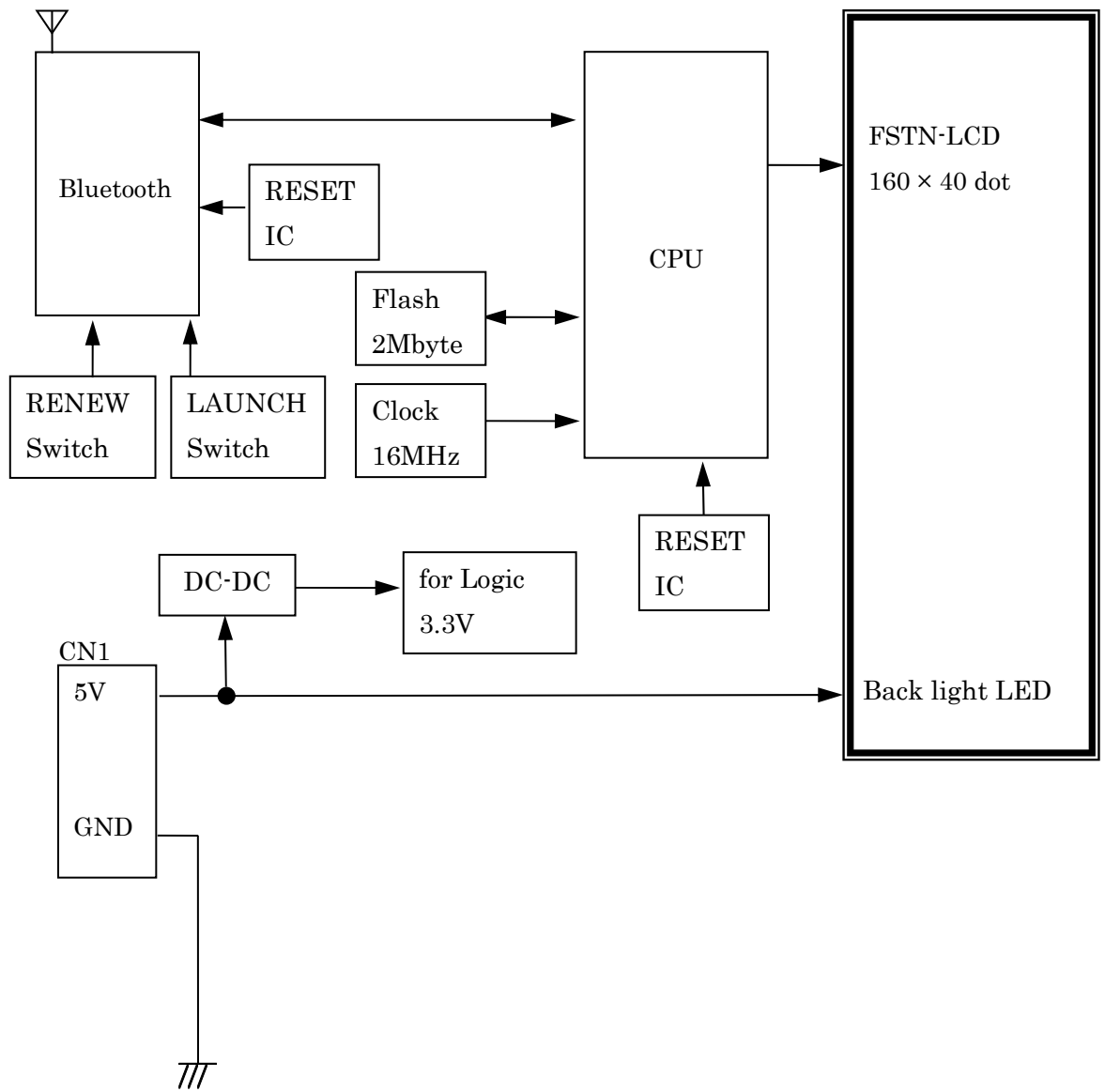

**Font Tables**

8x16 dot font

Common font

	0	1	2	3	4	5	6	7	8	9	A	B	C	D	E	F
2		!	"	#	\$	%	&	'	(	)	*	+	,	-	.	/
3	Ø	1	2	3	4	5	6	7	8	9	:	;	<	=	>	?
4	@	A	B	C	D	E	F	G	H	I	J	K	L	M	N	O
5	P	Q	R	S	T	U	V	W	X	Y	Z	[	\	]	^	_
6	`	a	b	c	d	e	f	g	h	i	j	k	l	m	n	o
7	p	q	r	s	t	u	v	w	x	y	z	{		}	~	

International font set

n	23	24	40	5B	5C	5D	5E	60	7B	7C	7D	7E
00	#	\$	@	[	\	]	^	`	{		}	~
01	#	\$	à	°	ç	š	^	`	é	ù	è	ˆ
02	#	\$	š	Ä	Ö	Ü	^	`	ä	ö	ü	ß
03	£	\$	@	[	\	]	^	`	{		}	~
04	#	\$	@	Æ	Ø	Å	^	`	æ	ø	å	~
05	#	¤	É	Ä	Ö	Å	Ü	é	ä	ö	å	ü
06	#	\$	@	°	\	é	^	ù	à	ò	è	ì
07	£	\$	@	ı	Ñ	¿	^	`	ˆ	ñ	}	~
08	#	\$	@	[	¥	]	^	`	{		}	~
09	#	¤	É	Æ	Ø	Å	Ü	é	æ	ø	å	ü
0A	#	\$	É	Æ	Ø	Å	Ü	é	æ	ø	å	ü
0B	#	\$	á	ı	Ñ	¿	é	`	í	ñ	ó	ú
0C	#	\$	á	ı	Ñ	¿	é	ü	í	ñ	ó	ú
0D	#	\$	@	[	¶	]	^	`	{		}	~

n=30h

	0	1	2	3	4	5	6	7	8	9	A	B	C	D	E	F
8	Ç	ü	é	â	ä	à	å	ç	ê	ë	è	ī	î	ì	Ä	Å
9	É	æ	Æ	ô	ö	ò	û	ù	ÿ	Ö	Ü	Φ	£	¥	℞	f
A	á	í	ó	ú	ñ	Ñ	æ	ø	¿	¬	½	¼	¡	«	»	
B	▯	▯	▯		├	┤	┥	┦	┧	┨	┩	┪	┫	┬	┭	
C	┮	┯	┰	┱	┲	┳	┴	┵	┶	┷	┸	┹	┺	┻	┼	
D	┽	┿	π	ℓ	ℓ	ℓ	π	≠	∟	∟	■	■	■	■	■	
E	α	β	Γ	π	Σ	σ	μ	τ	Φ	Θ	Ω	δ	∞	φ	ε	∩
F	≡	±	≥	≤	∫	∫	÷	≈	°	·	·	√	n	2	■	

n=31h

	0	1	2	3	4	5	6	7	8	9	A	B	C	D	E	F
8	▬	▬	▬	▬	▬	▬	▬	▬	▬	▬	▬	▬	▬			■
9			■	■	■	▯	▯	→	←	↑	↓	×	÷	±	≤	≥
A		。	「	」	、	・	ヲ	ア	イ	ウ	エ	オ	カ	キ	ク	ツ
B	ー	ア	イ	ウ	エ	オ	カ	キ	ク	ケ	コ	サ	シ	ス	セ	リ
C	夕	チ	ツ	テ	ト	ナ	ニ	ヌ	ネ	ノ	ハ	ヒ	フ	ハ	ホ	マ
D	ミ	ム	メ	モ	ヤ	ユ	ヨ	ラ	リ	ル	レ	ロ	ワ	ン	”	°
E	□	■	■	○	●	◇	◆	◆	▶	◀	▲	▼	«	»	½	¼
F	日	月	火	水	木	金	土	年	円	分	人	大	中	小	〒	

n=32h

	0	1	2	3	4	5	6	7	8	9	A	B	C	D	E	F
8	Ç	ü	é	â	ã	à	å	ç	ê	ë	è	ĩ	î	ì	Ã	Å
9	É	æ	Æ	ô	ö	ò	û	ù	ÿ	ÿ	Û	ø	£	Ø	×	f
A	á	í	ó	ú	ñ	Ñ	æ	ø	¿	®	¬	½	¼	¡	«	»
B	▯	▯	▯		†	Á	Â	À	©	¶		¶	¶	Φ	¥	∟
C	L	⊥	⊥	†	-	†	ã	Ã	ℓ	ℓ	⊥	π	¶	=	¶	⊗
D	ø	Ð	Ê	Ë	È	ı	í	î	ï	∟	ℓ	■	■		ì	■
E	Ó	β	Ô	Ò	Õ	μ	þ	Þ	Ú	Û	Û	ý	Ý	-	'	
F	-	±	=	¾	¶	§	÷	˘	°	¨	.	1	3	2	■	

n=33h

	0	1	2	3	4	5	6	7	8	9	A	B	C	D	E	F
8	Ç	ü	é	â	ã	à	Á	ç	ê	Ê	è	í	ô	ì	Ã	Å
9	É	À	È	ô	ö	ò	ú	ù	ì	õ	Û	Φ	£	Û	℞	Ó
A	á	í	ó	ú	ñ	Ñ	æ	ø	¿	Ò	¬	½	¼	¡	«	»
B	▯	▯	▯		†	†	¶	¶	¶		¶	¶	¶	¶	¶	∟
C	L	⊥	⊥	†	-	†	¶	¶	ℓ	ℓ	⊥	π	¶	=	¶	⊥
D	⊥	π	π	ℓ	ℓ	ℓ	π	¶	¶	∟	ℓ	■	■	■	■	■
E	α	β	Γ	π	Σ	σ	μ	τ	Φ	θ	Ω	δ	∞	φ	ε	∩
F	≡	±	≥	≤	∫	∫	÷	≈	°	.	.	√	n	2	■	

n=34h

	0	1	2	3	4	5	6	7	8	9	A	B	C	D	E	F
8	Ç	ü	é	â	Â	à	¶	ç	ê	ë	è	ï	î	=	À	Š
9	É	Ê	Ë	ô	Ë	Ï	û	ù	œ	ô	Û	ϕ	£	Û	Û	f
A	¡	´	ó	ú	¨	¸	³	¯	î	¬	¬	½	¼	¾	«	»
B	▤	▥	▦		†	‡	▨	π	⌞	⌟	▨	▨	▨	▨	▨	▨
C	⊥	⊥	⊥	†	-	†	‡	▨	⊥	⊥	⊥	⊥	⊥	=	⊥	⊥
D	⊥	⊥	⊥	⊥	⊥	⊥	⊥	⊥	⊥	⊥	⊥	■	■	■	■	■
E	α	β	Γ	π	Σ	σ	μ	τ	Φ	θ	Ω	δ	∞	φ	ε	∩
F	≡	±	≥	≤	∫	∫	÷	≈	°	·	·	√	n	2	■	

n=35h

	0	1	2	3	4	5	6	7	8	9	A	B	C	D	E	F
8	Ç	ü	é	â	ä	à	å	ç	ê	ë	è	ï	î	ì	Ä	Å
9	É	æ	Æ	ô	ö	ò	û	ù	ÿ	ÿ	Û	ø	£	Ø	℞	f
A	á	í	ó	ú	ñ	Ñ	æ	ø	¿	¬	¬	½	¼	¡	«	œ
B	▤	▥	▦		†	‡	▨	π	⌞	⌟	▨	▨	▨	▨	▨	▨
C	⊥	⊥	⊥	†	-	†	‡	▨	⊥	⊥	⊥	⊥	⊥	=	⊥	⊥
D	⊥	⊥	⊥	⊥	⊥	⊥	⊥	⊥	⊥	⊥	⊥	■	■	■	■	■
E	α	β	Γ	π	Σ	σ	μ	τ	Φ	θ	Ω	δ	∞	φ	ε	∩
F	≡	±	≥	≤	∫	∫	÷	≈	°	·	·	√	n	2	■	



n=36h

	0	1	2	3	4	5	6	7	8	9	A	B	C	D	E	F
8	€	,	f	„	…	†	‡	^	%	Š	<	Œ		Ž		
9		‘	’	“	”	•	-	-	~	™	Š	>	œ		ž	ÿ
A		ı	ϕ	ℓ	α	¥	ı	§	¨	©	®	«	¬	-	®	¯
B	°	±	²	³	´	µ	¶	·	¸	¹	º	»	¼	½	¾	¿
C	À	Á	Â	Ã	Ä	Å	Æ	Ç	È	É	Ê	Ë	Ì	Í	Î	Ï
D	Ð	Ñ	Ò	Ó	Ô	Õ	Ö	×	Ø	Ù	Ú	Û	Ü	Ý	Þ	ß
E	à	á	â	ã	ä	å	æ	ç	è	é	ê	ë	ì	í	î	ï
F	ð	ñ	ò	ó	ô	õ	ö	÷	ø	ù	ú	û	ü	ý	þ	ÿ

n=37h

	0	1	2	3	4	5	6	7	8	9	A	B	C	D	E	F
8	А	Б	В	Г	Д	Е	Ж	З	И	Й	К	Л	М	Н	О	П
9	Р	С	Т	У	Ф	Х	Ц	Ч	Ш	Щ	Ъ	Ы	Ь	Э	Ю	Я
A	а	б	в	г	д	е	ж	з	и	й	к	л	м	н	о	п
B	⋮	⋮	⋮		├	┤	┥	┦	┧	┨	┩	┪	┫	┬	┭	┮
C	┯	┰	┱	┲	┳	┴	┵	┶	┷	┸	┹	┺	┻	┼	┽	┾
D	┿	⌞	⌟	⌠	⌡	⌢	⌣	⌤	⌥	⌦	■	■	■	■	■	■
E	р	с	т	у	ф	х	ц	ч	ш	щ	ъ	ы	ь	э	ю	я
F	ѐ	ё	ѐ	е	ї	і	ÿ	ÿ	°	·	·	√	№	α	■	

n=38h

	0	1	2	3	4	5	6	7	8	9	A	B	C	D	E	F
8	Ç	ü	é	â	ã	û	ó	ç	ł	ë	ö	ó	î	ž	Ā	Ć
9	É	Ĺ	í	ô	ö	Ľ	ĺ	š	ś	ö	ü	ř	ť	ł	×	č
A	á	í	ó	ú	Ą	ą	Ż	ż	Ę	ę	¬	ż	Č	š	«	»
B	▯	▯	▯		†	Á	Â	Ě	Š	ǁ	ǁ	ǁ	ǁ	ǁ	ǁ	ǁ
C	Ł	ł	ł	ł	ł	ł	ł	ł	ł	ł	ł	ł	ł	ł	ł	ł
D	đ	Đ	Ď	Ě	ď	Ň	í	î	ě	ł	▯	▯	▯	▯	▯	▯
E	Ó	ß	ô	Ň	ň	ň	š	š	ř	ú	ř	ú	ý	ý	ł	´
F	-	˘	˙	˘	˘	š	÷	˙	°	˘	˙	ú	ř	ř	▯	

n=39h

	0	1	2	3	4	5	6	7	8	9	A	B	C	D	E	F
8	Ç	ü	é	â	ã	à	â	ç	ê	ë	è	ī	î	ì	Ā	Å
9	É	æ	Æ	ô	ö	ò	û	ù	ÿ	ö	ü	ø	ƒ	Ø	×	f
A	á	í	ó	ú	ñ	Ñ	æ	ø	ç	®	¬	½	¼	i	«	»
B	▯	▯	▯		†	Á	Â	À	©	ǁ	ǁ	ǁ	ǁ	ǁ	ǁ	ǁ
C	Ł	ł	ł	ł	ł	ł	ł	ł	ł	ł	ł	ł	ł	ł	ł	ł
D	ð	Ð	Ê	Ě	È	€	í	î	ī	ł	▯	▯	▯	▯	▯	▯
E	Ó	ß	ô	ò	õ	õ	µ	þ	þ	ú	û	û	ý	ý	ł	´
F	-	±	=	¾	ǁ	š	÷	˙	°	˘	˙	1	3	2	▯	

16x16dot font

n = 3Ah Japanese font(shift JIS)

Japanese font (shift JIS)

\*The displayed characters are Ming type.

	+0	+1	+2	+3	+4	+5	+6	+7	+8	+9	+A	+B	+C	+D	+E	+F	+10	+11	+12	+13	+14	+15	+16	+17	+18	+19	+1A	+1B	+1C	+1D	+1E	+1F	
A0	□	□	□	□	□	□	□	□	□	□	□	□	□	□	□	□	□	□	□	□	□	□	□	□	□	□	□	□	□	□	□	□	
C0	㊦	㊧	㊨	㊩	㊪	㊫	㊬	㊭	㊮	㊯	㊰	㊱	㊲	㊳	㊴	㊵	㊶	㊷	㊸	㊹	㊺	㊻	㊼	㊽	㊾	㊿	㊿	㊿	㊿	㊿	㊿	㊿	
8140	□	□	□	□	□	□	□	□	□	□	□	□	□	□	□	□	□	□	□	□	□	□	□	□	□	□	□	□	□	□	□		
8160	~			...	..	'	“	”	(	)	[	]	{	}	<	>	《	》	┌	┐	└	┘	├	┤	├	┤	+	-	±	×			
8180	÷	=	≠	<	>	≤	≥	∞	∴	♂	♀	°	′	″	℃	¥	\$	¢	‰	%	#	&	*	@	§	☆	★	○	●	◎	◇	◆	
81A0	□	■	△	▲	▽	▼	※	〒	→	←	↑	↓	≡																				
81C0																																	
81E0	≡	≡	≡	√	∞	∞	∴	∴	∴																								
8240																																	
8260	A	B	C	D	E	F	G	H	I	J	K	L	M	N	O	P	Q	R	S	T	U	V	W	X	Y	Z							
8280	a	b	c	d	e	f	g	h	i	j	k	l	m	n	o	p	q	r	s	t	u	v	w	x	y	z						あ	
82A0	あ	い	う	え	え	お	お	か	か	き	ぎ	く	く	け	げ	こ	こ	さ	さ	し	じ	ず	ず	せ	ぜ	そ	そ	た	だ	ち			
82C0	ぢ	っ	っ	づ	て	で	と	ど	な	に	ぬ	ね	の	は	ば	び	び	ぶ	ぶ	ぶ	へ	へ	へ	ほ	ほ	ほ	ま	み	む	め			
82E0	も	や	や	ゆ	ゆ	よ	よ	ら	り	る	ね	ろ	わ	わ	ぬ	ゑ	を	ん															
8340	ア	ア	イ	イ	ウ	ウ	エ	エ	オ	オ	カ	カ	キ	キ	ク	ク	ケ	ケ	コ	コ	サ	ザ	シ	ジ	ス	ズ	セ	ゼ	ソ	ゾ	タ	ダ	
8360	チ	チ	ツ	ツ	テ	テ	ト	ト	ナ	ナ	ニ	ネ	ノ	ハ	ハ	パ	ピ	ピ	フ	フ	ヘ	ヘ	ベ	ホ	ホ	ボ	マ	ミ					
8380	△	×	モ	ヤ	ユ	ユ	ヨ	ヨ	ラ	リ	ル	レ	ロ	ワ	ヰ	ヱ	ン	ヴ	カ	ケ												A	
83A0	B	Γ	Δ	E	Z	H	Θ	I	K	Λ	M	N	Ξ	O	Π	P	Σ	T	Υ	Φ	X	Ψ	Ω									α	
83C0	β	γ	δ	ε	ζ	η	θ	ι	κ	λ	μ	ν	ξ	ο	π	ρ	σ	τ	υ	φ	χ	ψ	ω										
83E0																																	
8440	А	Б	В	Г	Д	Е	Ё	Ж	З	И	Й	К	Л	М	Н	О	П	Р	С	Т	У	Ф	Х	Ц	Ч	Ш	Щ	Ъ	Ы	Ь	Э	Ю	
8460	Я																																
8480	о	п	р	с	т	у	ф	х	ц	ч	ш	щ	ъ	ы	ь	э	ю	я															
84A0	П	Г	Г	Г	Г	Г	Г	Г	Г	Г	Г	Г	Г	Г	Г	Г	Г	Г	Г	Г	Г	Г	Г	Г	Г	Г	Г	Г	Г	Г	Г	Г	
84C0																																	
84E0																																	
8540	!	”	#	\$	%	&	'	(	)	*	+	,	-	.	/	0	1	2	3	4	5	6	7	8	9	:	;	<	=	>	?	@	
8560	A	B	C	D	E	F	G	H	I	J	K	L	M	N	O	P	Q	R	S	T	U	V	W	X	Y	Z	[	¥	]	^	_		
8580	~	a	b	c	d	e	f	g	h	i	j	k	l	m	n	o	p	q	r	s	t	u	v	w	x	y	z	{		}	。		
85A0	┌	┐	┌	┐	┌	┐	┌	┐	┌	┐	┌	┐	┌	┐	┌	┐	┌	┐	┌	┐	┌	┐	┌	┐	┌	┐	┌	┐	┌	┐	┌	┐	
85C0	㊦	㊧	㊨	㊩	㊪	㊫	㊬	㊭	㊮	㊯	㊰	㊱	㊲	㊳	㊴	㊵	㊶	㊷	㊸	㊹	㊺	㊻	㊼	㊽	㊾	㊿	㊿	㊿	㊿	㊿	㊿	㊿	
85E0																																	
8640																																	
8660																																	
8680																																	
86A0																																	
86C0																																	
86E0																																	
8740	①	②	③	④	⑤	⑥	⑦	⑧	⑨	⑩	⑪	⑫	⑬	⑭	⑮	⑯	⑰	⑱	⑲	⑳	I	II	III	IV	V	VI	VII	VIII	IX	X	㊿		
8760	キ	キ	キ	キ	キ	キ	キ	キ	キ	キ	キ	キ	キ	キ	キ	キ	キ	キ	キ	キ	キ	キ	キ	キ	キ	キ	キ	キ	キ	キ	キ	キ	
8780	“	。 No.	KK	TEL	Ⓢ	Ⓢ	Ⓢ	Ⓢ	Ⓢ	Ⓢ	Ⓢ	Ⓢ	Ⓢ	Ⓢ	Ⓢ	Ⓢ	Ⓢ	Ⓢ	Ⓢ	Ⓢ	Ⓢ	Ⓢ	Ⓢ	Ⓢ	Ⓢ	Ⓢ	Ⓢ	Ⓢ	Ⓢ	Ⓢ	Ⓢ		
87A0																																	
87C0																																	
87E0																																	
8840																																	
8860																																	
8880																																	
88A0	啞	娃	阿	哀	愛	挨	始	逢	葵	茜	穉	惡	握	渥	旭	葦	薊	梓	庄	幹	扱	宛	姐	虻	飴	絢	綾	鮎	或	粟	裕		
88C0	安	庵	按	暗	案	闇	鞍	杏	以	伊	位	依	偉	囧	夷	委	威	尉	惟	意	慰	易	椅	為	畏	異	移	維	緯	胃	萎	衣	
88E0	謂	違	遺	医	井	亥	域	育	郁	磯	一	壹	溢	逸	稻	茨	芋	鰯	允	印	咽	員	因	姻	引	飲	淫	胤	蔭				











	+0	+1	+2	+3	+4	+5	+6	+7	+8	+9	+A	+B	+C	+D	+E	+F	+10	+11	+12	+13	+14	+15	+16	+17	+18	+19	+1A	+1B	+1C	+1D	+1E	+1F		
E940	顛	顛	顛	廐	廐	廐	廐	廐	廐	廐	廐	廐	廐	廐	廐	廐	廐	廐	廐	廐	廐	廐	廐	廐	廐	廐	廐	廐	廐	廐	廐	廐		
E960	饒	饒	饒	道	馥	馥	馥	馥	馥	馥	馥	馥	馥	馥	馥	馥	馥	馥	馥	馥	馥	馥	馥	馥	馥	馥	馥	馥	馥	馥	馥	馥		
E980	髡	髡	髡	髡	髡	髡	髡	髡	髡	髡	髡	髡	髡	髡	髡	髡	髡	髡	髡	髡	髡	髡	髡	髡	髡	髡	髡	髡	髡	髡	髡	髡		
E9A0	鬃	鬃	鬃	鬃	鬃	鬃	鬃	鬃	鬃	鬃	鬃	鬃	鬃	鬃	鬃	鬃	鬃	鬃	鬃	鬃	鬃	鬃	鬃	鬃	鬃	鬃	鬃	鬃	鬃	鬃	鬃	鬃		
E9C0	鯨	鯨	鯨	鯨	鯨	鯨	鯨	鯨	鯨	鯨	鯨	鯨	鯨	鯨	鯨	鯨	鯨	鯨	鯨	鯨	鯨	鯨	鯨	鯨	鯨	鯨	鯨	鯨	鯨	鯨	鯨	鯨		
E9E0	鰲	鰲	鰲	鰲	鰲	鰲	鰲	鰲	鰲	鰲	鰲	鰲	鰲	鰲	鰲	鰲	鰲	鰲	鰲	鰲	鰲	鰲	鰲	鰲	鰲	鰲	鰲	鰲	鰲	鰲	鰲	鰲		
EA40	鵝	鵝	鵝	鵝	鵝	鵝	鵝	鵝	鵝	鵝	鵝	鵝	鵝	鵝	鵝	鵝	鵝	鵝	鵝	鵝	鵝	鵝	鵝	鵝	鵝	鵝	鵝	鵝	鵝	鵝	鵝	鵝		
EA60	鸛	鸛	鸛	鸛	鸛	鸛	鸛	鸛	鸛	鸛	鸛	鸛	鸛	鸛	鸛	鸛	鸛	鸛	鸛	鸛	鸛	鸛	鸛	鸛	鸛	鸛	鸛	鸛	鸛	鸛	鸛	鸛	鸛	
EA80	徽	徽	徽	徽	徽	徽	徽	徽	徽	徽	徽	徽	徽	徽	徽	徽	徽	徽	徽	徽	徽	徽	徽	徽	徽	徽	徽	徽	徽	徽	徽	徽	徽	徽
EAA0	楨	達	瑤	涼	熙																													



n = 3Bh Simplified Chinese(GB2312)

	+0	+1	+2	+3	+4	+5	+6	+7	+8	+9	+A	+B	+C	+D	+E	+F	+10	+11	+12	+13	+14	+15	+16	+17	+18	+19	+1A	+1B	+1C	+1D	+1E	+1F							
A1A0	□	□	□	□	□	□	□	□	□	□	□	□	□	□	□	□	□	□	□	□	□	□	□	□	□	□	□	□	□	□	□	□							
A1C0	±	×	÷	√	∧	∨	∑	∏	∩	∪	∞	∫	∂	∇	∞	∞	∞	∞	∞	∞	∞	∞	∞	∞	∞	∞	∞	∞	∞	∞	∞								
A1E0	♀	♂	♀	♂	♀	♂	♀	♂	♀	♂	♀	♂	♀	♂	♀	♂	♀	♂	♀	♂	♀	♂	♀	♂	♀	♂	♀	♂	♀	♂	♀								
A2A0																		1.	2.	3.	4.	5.	6.	7.	8.	9.	10.	11.	12.	13.	14.	15.							
A2C0	16.	17.	18.	19.	20.	①	②	③	④	⑤	⑥	⑦	⑧	⑨	⑩	⑪	⑫	⑬	⑭	⑮	⑯	⑰	⑱	⑲	⑳	㉑	㉒	㉓	㉔	㉕	㉖								
A2E0	㉗	㉘	㉙	㉚	㉛	㉜	㉝	㉞	㉟	㊱	㊲	㊳	㊴	㊵	㊶	㊷	㊸	㊹	㊺	㊻	㊼	㊽	㊾	㊿	Ⅰ	Ⅱ	Ⅲ	Ⅳ	Ⅴ	Ⅵ	Ⅶ	Ⅷ	Ⅷ	Ⅸ	Ⅹ	Ⅺ	Ⅻ		
A3A0	!	"	#	¥	%	&	'	(	)	*	+	,	-	.	/	0	1	2	3	4	5	6	7	8	9	:	;	<	=	>	?								
A3C0	@	A	B	C	D	E	F	G	H	I	J	K	L	M	N	O	P	Q	R	S	T	U	V	W	X	Y	Z	[	\	]	^	_	□						
A3E0	a	b	c	d	e	f	g	h	i	j	k	l	m	n	o	p	q	r	s	t	u	v	w	x	y	z	{		}	□	□	□	□	□	□				
A4A0	あ	い	う	え	お	か	が	き	ぎ	く	け	こ	さ	ざ	し	じ	す	ず	せ	ぜ	そ	ぞ	た																
A4C0	だ	ち	っ	つ	て	と	ど	な	に	ぬ	ね	の	は	ば	び	び	び	ふ	ぶ	ぶ	へ	べ	べ	ほ	ぼ	ま	み												
A4E0	む	め	も	や	ゆ	よ	ら	り	る	ろ	わ	わ	ゑ	を	ん																								
A5A0	ア	イ	ウ	エ	オ	カ	キ	ク	ケ	コ	サ	シ	ス	セ	ソ	タ																							
A5C0	チ	ツ	テ	ト	ナ	ニ	ノ	ハ	パ	ヒ	フ	ブ	ヘ	ベ	ホ	マ																							
A5E0	ム	メ	モ	ヤ	ユ	ヨ	ラ	リ	ル	レ	ロ	ワ	ヰ	ヱ	ヰ	ヱ																							
A6A0	A	B	Γ	Δ	E	Z	H	Θ	I	K	Λ	M	N	Ξ	O	Π	P	Σ	T	Τ	Φ	X	Ψ	Ω															
A6C0	α	β	γ	δ	ε	ζ	η	θ	ι	κ	λ	μ	ν	ξ	ο	π	ρ	σ	τ	υ	φ	χ	ψ	ω															
A6E0																																							
A7A0	А	В	Г	Д	Е	Ё	Ж	З	И	Й	К	Л	М	Н	О	П	Р	С	Т	У	Ф	Х	Ц	Ч	Ш	Щ	Ъ	Ы	Ь	Э									
A7C0	Ю	Я																																					
A7E0	О	П	Р	С	Т	У	Ф	Х	Ц	Ч	Ш	Щ	Ъ	Ы	Ь	Э	Ю	Я																					
A8A0	ā	á	ǎ	à	ē	é	ě	è	í	í	ǐ	ì	ō	ó	ǒ	ò	ū	ú	ǔ	ù	ū	ú	ǘ	ù	ê														
A8C0																																							
A8E0	玄	又	弓	厶	尢	勹	勹	勹	勹	勹	勹	勹	勹	勹	勹	勹	勹	勹	勹	勹	勹	勹	勹	勹	勹	勹	勹	勹	勹	勹	勹	勹	勹	勹	勹	勹	勹		
A9A0																																							
A9C0	卍	卍	卍	卍	卍	卍	卍	卍	卍	卍	卍	卍	卍	卍	卍	卍	卍	卍	卍	卍	卍	卍	卍	卍	卍	卍	卍	卍	卍	卍	卍	卍	卍	卍	卍	卍	卍		
A9E0	卍	卍	卍	卍	卍	卍	卍	卍	卍	卍	卍	卍	卍	卍	卍	卍	卍	卍	卍	卍	卍	卍	卍	卍	卍	卍	卍	卍	卍	卍	卍	卍	卍	卍	卍	卍	卍	卍	
AAA0																																							
AAC0																																							
AAE0																																							
ABA0																																							
ABC0																																							
ABE0																																							
ACA0																																							
ACC0																																							
ACE0																																							
ADA0																																							
ADC0																																							
ADE0																																							
AEA0																																							
AEC0																																							
AEE0																																							
AFA0																																							
AFC0																																							
AFE0																																							
B0A0	啊	阿	埃	挨	哎	唉	哀	皑	癌	蔼	矮	艾	碍	爱	隘	鞅	氨	安	俺	按	暗	岸	腋	案	肮	昂	盎	凹	敖	熬	翱								
B0C0	袄	傲	奥	懊	澳	芭	捌	扒	叭	吧	笆	八	疤	巴	拔	跋	靶	把	耙	坝	霸	罢	爸	白	柏	百	摆	佰	败	拜	裨	斑							
B0E0	班	搬	扳	般	颁	扳	版	扮	拌	伴	瓣	半	办	絆	邦	帮	梆	榜	膀	绑	棒	磅	蚌	镑	傍	滂	苞	胞	包	褒	剥								

+0	B1A0	薄	+1	雷	+2	保	+3	堡	+4	宝	+5	抱	+6	报	+7	暴	+8	豹	+9	爆	+A	杯	+B	悲	+C	卑	+D	北	+E	背	+F	贝	+10	颀	+11	倍	+12	狷	+13	奋	+14	惫	+15	惫	+16	惫	+17	惫	+18	惫	+19	惫	+1A	惫	+1B	惫	+1C	惫	+1D	惫	+1E	惫	+1F	惫																													
B1C0	崩	编	B1E0	崩	B2A0	病	B2C0	怖	B2E0	侧	B3A0	忧	B3C0	赤	B4A0	砧	B4C0	蠢	B4E0	脆	B5A0	怠	B5C0	道	B5E0	糖	B6A0	独	B6C0	多	B7A0	防	B7C0	防	B7E0	粪	B8A0	浮	B8C0	附	B8E0	膏	B9A0	垢	B9C0	估	B9E0	灌	BAA0	骸	BAC0	豪	亨	BBA0	弧	BBC0	焕	BBE0	秽	BCA0	肌	BCC0	祭	BCE0	监	BDA0	健	BDC0	嚼	BDE0	洁	BEA0	尽	BEC0	纠	BEE0	距	BFA0	俊	BFC0	苛	BFE0	苦	COA0	绩	COC0	览	COE0	类				
薄	崩	编	崩	病	怖	侧	忧	赤	砧	蠢	脆	怠	道	糖	独	多	防	防	粪	浮	附	膏	垢	估	灌	骸	豪	亨	弧	焕	秽	肌	祭	监	健	嚼	洁	尽	纠	距	俊	苛	苦	绩	览	类	薄	崩	编	崩	病	怖	侧	忧	赤	砧	蠢	脆	怠	道	糖	独	多	防	防	粪	浮	附	膏	垢	估	灌	骸	豪	亨	弧	焕	秽	肌	祭	监	健	嚼	洁	尽	纠	距	俊	苛	苦	绩	览	类

+0	C1A0	痲	立	粒	溯	隶	力	璃	哩	俩	联	莲	连	镰	怜	涟	帘	敛	脸	铤	恋	炼	练	粮	凉	梁	梁	良	两	辆	量
+1	C1C0	亮	凉	撩	聊	僚	疗	燎	寥	辽	潦	了	连	镰	怜	涟	帘	敛	脸	铤	恋	炼	练	粮	凉	梁	梁	良	两	辆	量
+2	C1E0	玲	菱	零	龄	僚	伶	燎	寥	辽	潦	了	连	镰	怜	涟	帘	敛	脸	铤	恋	炼	练	粮	凉	梁	梁	良	两	辆	量
+3	C2A0	隆	垄	拢	陇	僚	伶	燎	寥	辽	潦	了	连	镰	怜	涟	帘	敛	脸	铤	恋	炼	练	粮	凉	梁	梁	良	两	辆	量
+4	C2C0	吕	铝	侣	履	僚	伶	燎	寥	辽	潦	了	连	镰	怜	涟	帘	敛	脸	铤	恋	炼	练	粮	凉	梁	梁	良	两	辆	量
+5	C2E0	锣	萝	裸	落	僚	伶	燎	寥	辽	潦	了	连	镰	怜	涟	帘	敛	脸	铤	恋	炼	练	粮	凉	梁	梁	良	两	辆	量
+6	C3A0	漫	芒	茫	盲	僚	伶	燎	寥	辽	潦	了	连	镰	怜	涟	帘	敛	脸	铤	恋	炼	练	粮	凉	梁	梁	良	两	辆	量
+7	C3C0	美	昧	寐	媚	僚	伶	燎	寥	辽	潦	了	连	镰	怜	涟	帘	敛	脸	铤	恋	炼	练	粮	凉	梁	梁	良	两	辆	量
+8	C3E0	绵	冕	免	媵	僚	伶	燎	寥	辽	潦	了	连	镰	怜	涟	帘	敛	脸	铤	恋	炼	练	粮	凉	梁	梁	良	两	辆	量
+9	C4A0	摹	磨	模	膜	僚	伶	燎	寥	辽	潦	了	连	镰	怜	涟	帘	敛	脸	铤	恋	炼	练	粮	凉	梁	梁	良	两	辆	量
+10	C4C0	睦	牧	穆	拿	僚	伶	燎	寥	辽	潦	了	连	镰	怜	涟	帘	敛	脸	铤	恋	炼	练	粮	凉	梁	梁	良	两	辆	量
+11	C4E0	泥	尼	拟	你	僚	伶	燎	寥	辽	潦	了	连	镰	怜	涟	帘	敛	脸	铤	恋	炼	练	粮	凉	梁	梁	良	两	辆	量
+12	C5A0	拧	泞	泞	牛	僚	伶	燎	寥	辽	潦	了	连	镰	怜	涟	帘	敛	脸	铤	恋	炼	练	粮	凉	梁	梁	良	两	辆	量
+13	C5C0	爬	帕	怕	琶	僚	伶	燎	寥	辽	潦	了	连	镰	怜	涟	帘	敛	脸	铤	恋	炼	练	粮	凉	梁	梁	良	两	辆	量
+14	C5E0	培	裴	陪	陪	僚	伶	燎	寥	辽	潦	了	连	镰	怜	涟	帘	敛	脸	铤	恋	炼	练	粮	凉	梁	梁	良	两	辆	量
+15	C6A0	啤	脾	疲	皮	僚	伶	燎	寥	辽	潦	了	连	镰	怜	涟	帘	敛	脸	铤	恋	炼	练	粮	凉	梁	梁	良	两	辆	量
+16	C6C0	评	屏	屏	泼	僚	伶	燎	寥	辽	潦	了	连	镰	怜	涟	帘	敛	脸	铤	恋	炼	练	粮	凉	梁	梁	良	两	辆	量
+17	C6E0	漓	漓	柒	沏	僚	伶	燎	寥	辽	潦	了	连	镰	怜	涟	帘	敛	脸	铤	恋	炼	练	粮	凉	梁	梁	良	两	辆	量
+18	C7A0	恰	洽	牵	其	僚	伶	燎	寥	辽	潦	了	连	镰	怜	涟	帘	敛	脸	铤	恋	炼	练	粮	凉	梁	梁	良	两	辆	量
+19	C7C0	抢	橇	鞞	敲	僚	伶	燎	寥	辽	潦	了	连	镰	怜	涟	帘	敛	脸	铤	恋	炼	练	粮	凉	梁	梁	良	两	辆	量
+20	C7E0	青	轻	氢	倾	僚	伶	燎	寥	辽	潦	了	连	镰	怜	涟	帘	敛	脸	铤	恋	炼	练	粮	凉	梁	梁	良	两	辆	量
+21	C8A0	取	娶	娶	娶	僚	伶	燎	寥	辽	潦	了	连	镰	怜	涟	帘	敛	脸	铤	恋	炼	练	粮	凉	梁	梁	良	两	辆	量
+22	C8C0	壤	壤	壤	让	僚	伶	燎	寥	辽	潦	了	连	镰	怜	涟	帘	敛	脸	铤	恋	炼	练	粮	凉	梁	梁	良	两	辆	量
+23	C8E0	揉	柔	肉	茹	僚	伶	燎	寥	辽	潦	了	连	镰	怜	涟	帘	敛	脸	铤	恋	炼	练	粮	凉	梁	梁	良	两	辆	量
+24	C9A0	伞	散	桑	噪	僚	伶	燎	寥	辽	潦	了	连	镰	怜	涟	帘	敛	脸	铤	恋	炼	练	粮	凉	梁	梁	良	两	辆	量
+25	C9C0	衫	闪	陕	擅	僚	伶	燎	寥	辽	潦	了	连	镰	怜	涟	帘	敛	脸	铤	恋	炼	练	粮	凉	梁	梁	良	两	辆	量
+26	C9E0	舌	舍	赦	掇	僚	伶	燎	寥	辽	潦	了	连	镰	怜	涟	帘	敛	脸	铤	恋	炼	练	粮	凉	梁	梁	良	两	辆	量
+27	CAA0	省	盛	剩	胜	僚	伶	燎	寥	辽	潦	了	连	镰	怜	涟	帘	敛	脸	铤	恋	炼	练	粮	凉	梁	梁	良	两	辆	量
+28	CAC0	世	柿	事	拭	僚	伶	燎	寥	辽	潦	了	连	镰	怜	涟	帘	敛	脸	铤	恋	炼	练	粮	凉	梁	梁	良	两	辆	量
+29	CAE0	枢	梳	殊	抒	僚	伶	燎	寥	辽	潦	了	连	镰	怜	涟	帘	敛	脸	铤	恋	炼	练	粮	凉	梁	梁	良	两	辆	量
+30	CBA0	恕	刷	耍	耍	僚	伶	燎	寥	辽	潦	了	连	镰	怜	涟	帘	敛	脸	铤	恋	炼	练	粮	凉	梁	梁	良	两	辆	量
+31	CBC0	死	肆	寺	嗣	僚	伶	燎	寥	辽	潦	了	连	镰	怜	涟	帘	敛	脸	铤	恋	炼	练	粮	凉	梁	梁	良	两	辆	量
+32	CBE0	肃	酸	蒜	算	僚	伶	燎	寥	辽	潦	了	连	镰	怜	涟	帘	敛	脸	铤	恋	炼	练	粮	凉	梁	梁	良	两	辆	量
+33	CCA0	獭	挞	搯	踏	僚	伶	燎	寥	辽	潦	了	连	镰	怜	涟	帘	敛	脸	铤	恋	炼	练	粮	凉	梁	梁	良	两	辆	量
+34	CCO0	汤	塘	塘	堂	僚	伶	燎	寥	辽	潦	了	连	镰	怜	涟	帘	敛	脸	铤	恋	炼	练	粮	凉	梁	梁	良	两	辆	量
+35	CCE0	梯	提	题	蹄	僚	伶	燎	寥	辽	潦	了	连	镰	怜	涟	帘	敛	脸	铤	恋	炼	练	粮	凉	梁	梁	良	两	辆	量
+36	CDA0	汀	廷	停	亭	僚	伶	燎	寥	辽	潦	了	连	镰	怜	涟	帘	敛	脸	铤	恋	炼	练	粮	凉	梁	梁	良	两	辆	量
+37	CDC0	屠	土	吐	兔	僚	伶	燎	寥	辽	潦	了	连	镰	怜	涟	帘	敛	脸	铤	恋	炼	练	粮	凉	梁	梁	良	两	辆	量
+38	CDE0	袜	歪	外	腕	僚	伶	燎	寥	辽	潦	了	连	镰	怜	涟	帘	敛	脸	铤	恋	炼	练	粮	凉	梁	梁	良	两	辆	量
+39	CEA0	巍	微	危	韦	僚	伶	燎	寥	辽	潦	了	连	镰	怜	涟	帘	敛	脸	铤	恋	炼	练	粮	凉	梁	梁	良	两	辆	量
+40	CEC0	卫	瘟	温	蚊	僚	伶	燎	寥	辽	潦	了	连	镰	怜	涟	帘	敛	脸	铤	恋	炼	练	粮	凉	梁	梁	良	两	辆	量
+41	CEE0	稽	吾	吴	毋	僚	伶	燎	寥	辽	潦	了	连	镰	怜	涟	帘	敛	脸	铤	恋	炼	练	粮	凉	梁	梁	良	两	辆	量
+42	CFA0	稀	息	希	悉	僚	伶	燎	寥	辽	潦	了	连	镰	怜	涟	帘	敛	脸	铤	恋	炼	练	粮	凉	梁	梁	良	两	辆	量
+43	CFC0	侠	狭	下	厦	僚	伶	燎	寥	辽	潦	了	连	镰	怜	涟	帘	敛	脸	铤	恋	炼	练	粮	凉	梁	梁	良	两	辆	量
+44	CHE0	相	厢	纒	香	僚	伶	燎	寥	辽	潦	了	连	镰	怜	涟	帘	敛	脸	铤	恋	炼	练	粮	凉	梁	梁	良	两	辆	量
+45	DOA0	小	孝	校	肖	僚	伶	燎	寥	辽	潦	了	连	镰	怜	涟	帘	敛	脸	铤	恋	炼	练	粮	凉	梁	梁	良	两	辆	量
+46	DOC0	欣	辛	新	忻	僚	伶	燎	寥	辽	潦	了	连	镰	怜	涟	帘	敛	脸	铤	恋	炼	练	粮	凉	梁	梁	良	两	辆	量
+47	DOE0	朽	嗅	锈	秀	僚	伶	燎	寥	辽	潦	了	连	镰	怜	涟	帘	敛	脸	铤	恋	炼	练	粮	凉	梁	梁	良	两	辆	量









n =3Ch Traditional Chinese(Big5)

	+0	+1	+2	+3	+4	+5	+6	+7	+8	+9	+A	+B	+C	+D	+E	+F	+10	+11	+12	+13	+14	+15	+16	+17	+18	+19	+1A	+1B	+1C	+1D	+1E	+1F			
A140	□	◊	◊	◊	◊	◊	◊	◊	◊	◊	◊	◊	◊	◊	◊	◊	◊	◊	◊	◊	◊	◊	◊	◊	◊	◊	◊	◊	◊	◊	◊	◊			
A160	⌈	⌋	⌈	⌋	⌈	⌋	⌈	⌋	⌈	⌋	⌈	⌋	⌈	⌋	⌈	⌋	⌈	⌋	⌈	⌋	⌈	⌋	⌈	⌋	⌈	⌋	⌈	⌋	⌈	⌋	⌈	⌋			
A1A0	{	}	{	}	{	}	{	}	{	}	{	}	{	}	{	}	{	}	{	}	{	}	{	}	{	}	{	}	{	}	{	}	{	}	
A1C0	Ⓢ	Ⓢ	Ⓢ	Ⓢ	Ⓢ	Ⓢ	Ⓢ	Ⓢ	Ⓢ	Ⓢ	Ⓢ	Ⓢ	Ⓢ	Ⓢ	Ⓢ	Ⓢ	Ⓢ	Ⓢ	Ⓢ	Ⓢ	Ⓢ	Ⓢ	Ⓢ	Ⓢ	Ⓢ	Ⓢ	Ⓢ	Ⓢ	Ⓢ	Ⓢ	Ⓢ	Ⓢ			
A1E0	<	>	=	~	∩	∪	∩	∪	∩	∪	∩	∪	∩	∪	∩	∪	∩	∪	∩	∪	∩	∪	∩	∪	∩	∪	∩	∪	∩	∪	∩	∪	∩		
A240	∕	∕	∕	\$	¥	₹	₹	₹	₹	₹	₹	₹	₹	₹	₹	₹	₹	₹	₹	₹	₹	₹	₹	₹	₹	₹	₹	₹	₹	₹	₹	₹	₹		
A260	𠄎	𠄎	𠄎	𠄎	𠄎	𠄎	𠄎	𠄎	𠄎	𠄎	𠄎	𠄎	𠄎	𠄎	𠄎	𠄎	𠄎	𠄎	𠄎	𠄎	𠄎	𠄎	𠄎	𠄎	𠄎	𠄎	𠄎	𠄎	𠄎	𠄎	𠄎	𠄎	𠄎		
A2A0	𠄎	𠄎	𠄎	𠄎	𠄎	𠄎	𠄎	𠄎	𠄎	𠄎	𠄎	𠄎	𠄎	𠄎	𠄎	𠄎	𠄎	𠄎	𠄎	𠄎	𠄎	𠄎	𠄎	𠄎	𠄎	𠄎	𠄎	𠄎	𠄎	𠄎	𠄎	𠄎	𠄎		
A2C0	Ⅷ	Ⅷ	Ⅷ	Ⅷ	Ⅷ	Ⅷ	Ⅷ	Ⅷ	Ⅷ	Ⅷ	Ⅷ	Ⅷ	Ⅷ	Ⅷ	Ⅷ	Ⅷ	Ⅷ	Ⅷ	Ⅷ	Ⅷ	Ⅷ	Ⅷ	Ⅷ	Ⅷ	Ⅷ	Ⅷ	Ⅷ	Ⅷ	Ⅷ	Ⅷ	Ⅷ	Ⅷ	Ⅷ	Ⅷ	
A2E0	R	S	T	U	V	W	X	Y	Z	a	b	c	d	e	f	g	h	i	j	k	l	m	n	o	p	q	r	s	t	u	v				
A340	w	x	y	z	A	B	Γ	Δ	E	Z	H	Θ	I	K	Λ	M	N	Ξ	O	Π	P	Σ	T	Υ	Φ	X	Ψ	Ω	α	β	γ	δ			
A360	ε	ζ	η	θ	ι	κ	λ	μ	ν	ξ	ο	π	ρ	σ	τ	υ	φ	χ	ψ	ω	ς	ς	ς	ς	ς	ς	ς	ς	ς	ς	ς	ς	ς	ς	
A3A0	ϣ	ϣ	ϣ	ϣ	ϣ	ϣ	ϣ	ϣ	ϣ	ϣ	ϣ	ϣ	ϣ	ϣ	ϣ	ϣ	ϣ	ϣ	ϣ	ϣ	ϣ	ϣ	ϣ	ϣ	ϣ	ϣ	ϣ	ϣ	ϣ	ϣ	ϣ	ϣ	ϣ	ϣ	
A3C0	□	□	□	□	□	□	□	□	□	□	□	□	□	□	□	□	□	□	□	□	□	□	□	□	□	□	□	□	□	□	□	□	□	□	□
A3E0	□	□	□	□	□	□	□	□	□	□	□	□	□	□	□	□	□	□	□	□	□	□	□	□	□	□	□	□	□	□	□	□	□	□	□
A440	一	乙	丁	七	乃	九	了	二	人	儿	入	八	几	刀	刁	力	匕	十	卜	又	三	下	丈	上	丫	凡	凡	久	么	也	乞	于			
A460	亡	元	刃	勾	千	叉	口	土	士	夕	天	女	子	子	寸	小	无	尸	山	川	工	己	己	己	巾	干	干	丹	弋	弓	才				
A4A0	丑	丐	丩	丩	丩	丩	丩	丩	丩	丩	丩	丩	丩	丩	丩	丩	丩	丩	丩	丩	丩	丩	丩	丩	丩	丩	丩	丩	丩	丩	丩	丩	丩	丩	
A4C0	分	切	刈	勾	勾	勿	化	匹	午	升	卅	卞	厄	友	及	反	壬	天	夫	太	天	孔	少	尤	尺	屯	巴	幻	廿	弔	引	心			
A4E0	戈	戶	手	扎	支	文	斗	斤	方	日	曰	月	木	欠	正	歹	毋	比	毛	氏	水	火	爪	父	爻	片	牙	半	犬	王	丙				
A540	世	丕	且	丘	主	乍	乏	乎	以	付	仔	仕	他	仗	代	令	仙	仞	充	兄	再	冊	冬	凹	出	凸	刊	加	功	包	匆	北			
A560	匹	任	半	弄	卡	占	卯	危	去	可	古	右	召	叮	叩	叨	司	回	叫	另	只	史	叱	台	句	吠	叨	叻	四	囚	外				
A5A0	央	失	奴	奶	孕	它	尼	巨	巧	左	市	布	平	幼	弁	弘	弗	必	戊	打	扔	扒	扌	扌	扌	扌	扌	扌	扌	扌	扌	扌	扌		
A5C0	母	民	氏	永	汗	汀	汜	犯	玄	玉	瓜	瓦	甘	生	用	甩	田	由	甲	申	申	申	申	申	申	申	申	申	申	申	申	申	申	申	
A5E0	丞	丟	兵	兵	乱	瓦	交	亦	亥	仿	伙	伊	伏	伍	伐	休	伏	仲	伴	任	仰	批	份	企	彼	光	晃	兆	先	全					
A640	共	再	冰	列	刑	划	刎	劣	匈	匡	匠	印	危	吉	吏	同	吊	吐	吁	吋	各	向	宅	安	寺	尖	后	屹	州	帆	并	年			
A660	圳	地	在	圭	圉	圉	夙	多	夷	夸	妄	奸	妃	好	她	如	妁	字	存	朽	守	宅	安	寺	尖	后	屹	州	帆	并	年				
A6A0	式	弛	忙	忖	戎	戎	戎	扣	扛	托	收	早	旨	旬	旭	曲	曳	有	朽	朴	朱	采	肉	次	此	死	氦	波	汗	汗	江				
A6C0	池	汐	汕	污	汎	汎	汎	灰	牟	牝	百	竹	米	糸	缶	羊	羽	老	考	而	何	估	佐	佑	伽	伺	伸	佃	似	但	吾	否			
A6E0	舟	良	色	艾	虫	血	行	衣	西	阡	串	亨	位	往	伶	佗	佞	佛	何	创	劫	助	努	劬	匣	即	卵	吝	吭	吞	毋	否			
A740	作	你	伯	低	伶	余	佻	佻	佻	佻	佻	佻	佻	佻	佻	佻	佻	佻	佻	佻	佻	佻	佻	佻	佻	佻	佻	佻	佻	佻	佻	佻	佻	佻	
A760	呖	吧	呆	呢	吳	呈	呂	君	吩	告	吹	吻	吸	吮	吮	吮	吮	吮	吮	吮	吮	吮	吮	吮	吮	吮	吮	吮	吮	吮	吮	吮	吮	吮	
A7A0	均	坎	坎	坐	坏	圻	壯	爽	版	妒	妨	姪	姪	姪	姪	姪	姪	姪	姪	姪	姪	姪	姪	姪	姪	姪	姪	姪	姪	姪	姪	姪	姪	姪	
A7C0	尾	岐	岑	岔	岌	巫	希	序	底	床	廷	弄	弟	形	形	衍	役	忘	忌	志	忍	忧	快	忤	忤	忤	忤	忤	忤	忤	忤	忤	忤	忤	
A7E0	挟	扭	把	扼	找	批	扳	抒	扯	折	扮	投	抓	抑	技	改	攻	攸	攸	更	季	杏	材	村	杜	杖	杞	杉	杆	杠					
A840	杓	杓	步	每	求	隶	沙	沁	沈	沉	沅	沛	汪	决	沐	汰	沌	泪	冲	浚	汽	沃	汲	汾	沔	沔	沔	沔	沔	沔	沔	沔	沔	沔	
A860	灼	灾	炎	牢	牡	牝	狄	狂	玖	甫	甫	男	甸	皂	盯	矣	私	秀	秃	究	系	罕	肖	肖	肖	肖	肖	肖	肖	肖	肖	肖	肖	肖	
A8A0	芋	苟	見	角	言	谷	豆	豕	貝	赤	走	足	身	車	辛	辰	迂	迪	迅	迄	巡	邕	邕	邕	邕	邕	邕	邕	邕	邕	邕	邕	邕	邕	
A8C0	阡	阡	阡	並	乖	乳	事	些	亞	享	京	祥	依	待	佳	使	佬	供	例	來	侃	倂	倂	倂	倂	倂	倂	倂	倂	倂	倂	倂	倂	倂	
A8E0	兒	兇	兩	具	其	典	冽	函	刻	券	刷	刺	到	刮	制	剝	劾	劾	卒	協	卓	卑	卦	卷	卸	卸	取	取	取	取	取	取	取		
A940	咖	吓	咕	咀	呻	呖	咒	咆	呼	附	呱	呱	呱	呱	呱	呱	呱	呱	呱	呱	呱	呱	呱	呱	呱	呱	呱	呱	呱	呱	呱	呱	呱	呱	
A960	奈	畜	奔	妾	妻	委	妹	妮	姑	姆	姐	姪	始	姓	姊	姊	姊	姊	姊	姊	姊	姊	姊	姊	姊	姊	姊	姊	姊	姊	姊	姊	姊	姊	
A9A0	屆	岷	岡	岸	岩	岫	岱	岳	帝	帝	帝	帝	帝	帝	帝	帝	帝	帝	帝	帝	帝	帝	帝	帝	帝	帝	帝	帝	帝	帝	帝	帝	帝	帝	
A9C0	念	忿	快	怔	怯	怵	怪	怕	怡	性	悒	悒	悒	悒	悒	悒	悒	悒	悒	悒	悒	悒	悒	悒	悒	悒	悒	悒	悒	悒	悒	悒	悒	悒	
A9E0	拈	揅	抽	押	拐	拙	搦	拍	抵	拚	抱	拘	拖	拗	拆	抬	拎	放	松	析	杵	杵	杵	杵	杵	杵	杵	杵	杵	杵	杵	杵	杵	杵	
AA40	鼻	服	朋	杭	枋	枕	東	果	香	杷	枇	枝	林	杯	杰	板	枉	松	析	杵	杵	杵	杵	杵	杵	杵	杵	杵	杵	杵	杵	杵	杵	杵	
AA60	注	泳	沱	泌	泥	河	沽	沽	沼	波	沫	法	泓	沸	泄	油	況	沮	泗	泗	泗	泗	泗	泗	泗	泗	泗	泗	泗	泗	泗	泗	泗	泗	泗
AAA0	炕	炎	炒	炊	炙	爬	爭	鬻	版	牧	物	狀	狎	狎	狎	狎	狎	狎	狎	狎	狎	狎	狎	狎	狎	狎	狎	狎	狎	狎	狎	狎	狎	狎	

























n =3Dh Hangul(KSC5601)

	+0	+1	+2	+3	+4	+5	+6	+7	+8	+9	+A	+B	+C	+D	+E	+F	+10	+11	+12	+13	+14	+15	+16	+17	+18	+19	+1A	+1B	+1C	+1D	+1E	+1F
A1A0	□	□	○	□	□	□	□	□	□	□	□	□	□	□	□	□	□	□	□	□	□	□	□	□	□	□	□	□	□	□	□	□
A1C0	÷	≠	≤	≥	∞	∴	∅	∅	∅	∅	∅	∅	∅	∅	∅	∅	∅	∅	∅	∅	∅	∅	∅	∅	∅	∅	∅	∅	∅	∅	∅	
A1E0	□	■	△	▲	▽	▼	→	←	↑	↓	↔	≡	≪	≫	√	∞	∞	∴	∫	∫	∫	∫	∫	∫	∫	∫	∫	∫	∫	∫	∫	
A2A0	⇒	⇐	▽	≡	□	□	□	□	□	□	□	□	□	□	□	□	□	□	□	□	□	□	□	□	□	□	□	□	□	□	□	
A2C0	♣	♠	♦	♠	♣	♣	♣	♣	♣	♣	♣	♣	♣	♣	♣	♣	♣	♣	♣	♣	♣	♣	♣	♣	♣	♣	♣	♣	♣	♣	♣	
A2E0	No	Co	TM	am	pm	Tel																										
A3A0	!	"	#	\$	%	&	'	(	)	*	+	,	-	.	/	0	1	2	3	4	5	6	7	8	9	:	;	<	=	>	?	
A3C0	@	A	B	C	D	E	F	G	H	I	J	K	L	M	N	O	P	Q	R	S	T	U	V	W	X	Y	Z	[	]	^	_	
A3E0	□	a	b	c	d	e	f	g	h	i	j	k	l	m	n	o	p	q	r	s	t	u	v	w	x	y	z	{	}	□	□	
A4A0	ㄱ	ㅋ	ㆁ	ㄴ	ㄷ	ㄹ	ㅁ	ㅂ	ㅅ	ㅇ	ㅈ	ㅊ	ㅌ	ㅍ	ㅑ	ㅓ	ㅕ	ㅗ	ㅛ	ㅜ	ㅠ	ㅡ	ㅣ	ㅞ	ㅟ	ㅠ	ㅡ	ㅢ	ㅣ	ㅤ	ㅥ	
A4C0	ㅦ	ㅧ	ㅨ	ㅩ	ㅪ	ㅫ	ㅬ	ㅭ	ㅮ	ㅯ	ㅰ	ㅱ	ㅲ	ㅳ	ㅴ	ㅵ	ㅶ	ㅷ	ㅸ	ㅹ	ㅺ	ㅻ	ㅼ	ㅽ	ㅾ	ㅿ	ㅿ	ㅿ	ㅿ	ㅿ	ㅿ	
A4E0	ㅿ	ㅿ	ㅿ	ㅿ	ㅿ	ㅿ	ㅿ	ㅿ	ㅿ	ㅿ	ㅿ	ㅿ	ㅿ	ㅿ	ㅿ	ㅿ	ㅿ	ㅿ	ㅿ	ㅿ	ㅿ	ㅿ	ㅿ	ㅿ	ㅿ	ㅿ	ㅿ	ㅿ	ㅿ	ㅿ	ㅿ	
A5A0	i	ii	iii	iv	v	vi	vii	viii	ix	x																						
A5C0	A	B	Γ	Δ	E	Z	H	Θ	I	K	Λ	M	N	Ξ	O	Π	P	Σ	T	Υ	Φ	X	Ψ	Ω								
A5E0	α	β	γ	δ	ε	ζ	η	θ	ι	κ	λ	μ	ν	ξ	ο	π	ρ	σ	τ	υ	φ	χ	ψ	ω								
A6A0	□	□	□	□	□	□	□	□	□	□	□	□	□	□	□	□	□	□	□	□	□	□	□	□	□	□	□	□	□	□	□	
A6C0	□	□	□	□	□	□	□	□	□	□	□	□	□	□	□	□	□	□	□	□	□	□	□	□	□	□	□	□	□	□	□	
A6E0	□	□	□	□	□																											
A7A0	ul	ml	dl	l	kl	cc	mm	cm	m	km	fm	nm	um	mm	cm	km	mm	cm	m	km	ha	ug	mg	kg	kt	cal	kcal	dB	%	%	ps	
A7C0	ns	us	ms	pv	nv	uv	mv	kv	MV	pA	nA	uA	mA	kA	pW	nW	uW	mW	kW	MW	Hz	kHz	MHz	GHz	THz	Ω	kΩ	MΩ	pF	nF	uF	mol
A7E0	cd	rad	%	%	sr	Pa	kPa	MPa	GPa	Wb	lm	lx	Bq	Gy	Sv	%																
A8A0	Æ	Ð	Ǽ	Ɔ	Ɔ	Ɔ	Ɔ	Ɔ	Ɔ	Ɔ	Ɔ	Ɔ	Ɔ	Ɔ	Ɔ	Ɔ	Ɔ	Ɔ	Ɔ	Ɔ	Ɔ	Ɔ	Ɔ	Ɔ	Ɔ	Ɔ	Ɔ	Ɔ	Ɔ	Ɔ	Ɔ	
A8C0	Ⓐ	Ⓑ	Ⓒ	Ⓓ	Ⓔ	Ⓕ	Ⓖ	Ⓗ	Ⓘ	Ⓚ	Ⓛ	Ⓜ	Ⓝ	Ⓞ	Ⓟ	Ⓠ	Ⓡ	Ⓢ	Ⓣ	Ⓤ	Ⓥ	Ⓦ	Ⓧ	Ⓨ	Ⓩ	ⓐ	ⓑ	ⓒ	ⓓ	ⓔ	ⓕ	
A8E0	ⓖ	ⓗ	ⓘ	ⓙ	ⓚ	ⓛ	ⓜ	ⓝ	ⓞ	ⓟ	ⓠ	ⓡ	ⓢ	ⓣ	ⓤ	ⓥ	ⓦ	ⓧ	ⓨ	ⓩ	⓪	⓫	⓬	⓭	⓮	⓯	⓰	⓱	⓲	⓳	⓴	
A9A0	⓵	⓶	⓷	⓸	⓹	⓺	⓻	⓼	⓽	⓾	⓿	Ⓚ	Ⓛ	Ⓜ	Ⓝ	Ⓞ	Ⓟ	Ⓠ	Ⓡ	Ⓢ	Ⓣ	Ⓤ	Ⓥ	Ⓦ	Ⓧ	Ⓨ	Ⓩ	ⓐ	ⓑ	ⓒ	ⓓ	
A9C0	ⓔ	ⓕ	ⓖ	ⓗ	ⓘ	ⓙ	ⓚ	ⓛ	ⓜ	ⓝ	ⓞ	ⓟ	ⓠ	ⓡ	ⓢ	ⓣ	ⓤ	ⓥ	ⓦ	ⓧ	ⓨ	ⓩ	⓪	⓫	⓬	⓭	⓮	⓯	⓰	⓱	⓲	
A9E0	⓴	⓵	⓶	⓷	⓸	⓹	⓺	⓻	⓼	⓽	⓾	⓿	Ⓚ	Ⓛ	Ⓜ	Ⓝ	Ⓞ	Ⓟ	Ⓠ	Ⓡ	Ⓢ	Ⓣ	Ⓤ	Ⓥ	Ⓦ	Ⓧ	Ⓨ	Ⓩ	ⓐ	ⓑ	ⓒ	
AAA0	ㅏ	ㅑ	ㅓ	ㅕ	ㅗ	ㅛ	ㅜ	ㅠ	ㅡ	ㅣ	ㅞ	ㅟ	ㅠ	ㅡ	ㅢ	ㅣ	ㅤ	ㅥ	ㅦ	ㅧ	ㅨ	ㅩ	ㅪ	ㅫ	ㅬ	ㅭ	ㅮ	ㅯ	ㅰ	ㅱ	ㅲ	
AAC0	ㅳ	ㅴ	ㅵ	ㅶ	ㅷ	ㅸ	ㅹ	ㅺ	ㅻ	ㅼ	ㅽ	ㅾ	ㅿ	ㅿ	ㅿ	ㅿ	ㅿ	ㅿ	ㅿ	ㅿ	ㅿ	ㅿ	ㅿ	ㅿ	ㅿ	ㅿ	ㅿ	ㅿ	ㅿ	ㅿ	ㅿ	
AAE0	ㅿ	ㅿ	ㅿ	ㅿ	ㅿ	ㅿ	ㅿ	ㅿ	ㅿ	ㅿ	ㅿ	ㅿ	ㅿ	ㅿ	ㅿ	ㅿ	ㅿ	ㅿ	ㅿ	ㅿ	ㅿ	ㅿ	ㅿ	ㅿ	ㅿ	ㅿ	ㅿ	ㅿ	ㅿ	ㅿ	ㅿ	
ABA0	ㅿ	ㅿ	ㅿ	ㅿ	ㅿ	ㅿ	ㅿ	ㅿ	ㅿ	ㅿ	ㅿ	ㅿ	ㅿ	ㅿ	ㅿ	ㅿ	ㅿ	ㅿ	ㅿ	ㅿ	ㅿ	ㅿ	ㅿ	ㅿ	ㅿ	ㅿ	ㅿ	ㅿ	ㅿ	ㅿ	ㅿ	
ABC0	ㅿ	ㅿ	ㅿ	ㅿ	ㅿ	ㅿ	ㅿ	ㅿ	ㅿ	ㅿ	ㅿ	ㅿ	ㅿ	ㅿ	ㅿ	ㅿ	ㅿ	ㅿ	ㅿ	ㅿ	ㅿ	ㅿ	ㅿ	ㅿ	ㅿ	ㅿ	ㅿ	ㅿ	ㅿ	ㅿ	ㅿ	
ABE0	ㅿ	ㅿ	ㅿ	ㅿ	ㅿ	ㅿ	ㅿ	ㅿ	ㅿ	ㅿ	ㅿ	ㅿ	ㅿ	ㅿ	ㅿ	ㅿ	ㅿ	ㅿ	ㅿ	ㅿ	ㅿ	ㅿ	ㅿ	ㅿ	ㅿ	ㅿ	ㅿ	ㅿ	ㅿ	ㅿ	ㅿ	
ACA0	A	B	В	Г	Д	E	Ё	Ж	З	И	Й	К	Л	М	Н	О	П	Р	С	Т	У	Ф	Х	Ц	Ч	Ш	Щ	Ъ	Ы	Ь	Э	
ACC0	Ю	Я																														
ACE0	О	П	р	с	т	у	ф	х	ц	ч	ш	щ	ъ	ы	ь	э	ю	я														
ADA0																																
ADC0																																
ADE0																																
AEA0																																
AEC0																																
AEE0																																
AFA0																																
AFC0																																
AFE0																																
BOA0	가	각	간	감	갈	값	값	감	갑	값	갓	갓	장	값	값	갈	값	갈	개	객	간	갯	갯	갯	갯	갯	갯	갯	갯	갯	갯	
BOC0	갯	갯	갯	갯	갯	갯	갯	갯	갯	갯	갯	갯	갯	갯	갯	갯	갯	갯	갯	갯	갯	갯	갯	갯	갯	갯	갯	갯	갯	갯	갯	
BOE0	갯	갯	갯	갯	갯	갯	갯	갯	갯	갯	갯	갯	갯	갯	갯	갯	갯	갯	갯	갯	갯	갯	갯	갯	갯	갯	갯	갯	갯	갯	갯	















## 6. 保証 WARRANTY

保証期間は弊社出荷後 1 年とする。

This display module is guranteed for 1 year after the shipment from FUTABA.

## 7. 規制物資等の該非判定及び、輸出する際の注意事項

### CAUTIONS FOR DETERMINING AND EXPORTING REGULATED GOODS OR SERVICES

本製品は、技術レベル的には外国為替管理令および輸出貿易管理令の規制上の物資（役務）等に非該当となりますが、他の装置の為に特別に設計した部分品・付属品はその装置の該・非判定により決定されます。

本製品を貴社製装置にご使用頂く弊社製汎用品に付きましては、貴社にて該・非判定をお願いすると共に、汎用品についても兵器等の製造に転用されることのないようご確認をお願い申し上げます。また、その結果、必要に応じた輸出手続等のご処置も併せてお願い申し上げます。

This product does not correspond to the goods or services regulated by Japan's Foreign Exchange and Foreign Trade Law. If this product is combined with other products in order to make equipment, whether this product is regulated or not is judged by such newly made equipment. We ask you to determine by yourself whether the equipment corresponds to the regulated goods when this product is incorporated in the equipment. We also ask you to confirm that this product will not be incorporated in any weapon or used for manufacturing any weapon. If you export or re-export this product, we recommend you to adopt measures for appropriate export procedures, if any

## 8. 環境対応 ENVIRONMENTALLY CONSCIENTIOUS

本製品は RoHS 適合品です。

This Module complies with RoHS Directive.

### 8.1 EU RoHS 指令に対して With respect to EU RoHS Directive

含有禁止物質である 6 物質（カドミウム、六価クロム、鉛、水銀、ポリ臭化ジフェニル類（PBB 類）、ポリ臭化ジフェニルエーテル類（PBDE 類））が RoHS 指令に規定される許容値以下、又は、適用除外項目に相当します。

EU RoHS 指令の適用除外については、EU RoHS 指令第4条に準ずるものが対象となります。

The contained amount of six prohibited substances in this product , which are cadmium, hexavalent chromium, lead, mercury, polybrominated biphenyl:PBB and polybrominated diphenyl ether :PBDE, is less than the permitted level stipulated in the EU RoHS Directive, or these substances are not included in the Directive.

The substances excluded are based on Article 4 of the EU RoHS Directive.

### 8.2 中国RoHS に対して With respect to Chinese RoHS

含有禁止物質である6物質（カドミウム、六価クロム、鉛、水銀、ポリ臭化ジフェニル類（PBB類）、ポリ臭化ジフェニルエーテル類（PBDE類））が中国RoHS指令に規定される許容値以下となります。

The contained amount of six prohibited substances in this product , which are cadmium,