

Overview

Multilayer piezoelectric actuators are ceramic elements used to convert electrical energy into mechanical energy such as displacement or force by utilizing the piezoelectric longitudinal effect.

KEMET's multilayer piezoelectric actuators are produced based on our unique element structure design and piezoelectric ceramic materials with high electrostrictive factors. Compared to conventional piezoelectric actuators, they are smaller in size but can generate higher displacements and forces at low voltages.

The AHB Metal Sealed 85°C High Performance series actuators are less impacted by ambient humidity due to insulation from the atmosphere. As a result, long operational life and high performance have been attained which are ideal for use in various high reliability applications such as semiconductor device production equipment and optical communication equipment.

Applications

Typical applications include fine adjustment of various X-Y table steppers, mirror/prism positioning, linear motors, fluid flow control valve drive, vibration source and manipulators.



Benefits

- High reliability: Realization of MTTF = 36,000 hours at 85°C and 100 V
- Large displacement type
- Operating temperature range from -25°C to +85°C
- Built-in pre-load mechanism and mounting attachments allowing for easier installation into equipment
- Accurate nanometer positioning
- Minimum mechanical abrasion
- Large generated force of 800 N
- Long operational life
- RoHS/REACH compliant

Ordering Information

AH	B	170	C	801	N	D	0	-A0	LF
Series	Housing Construction and Operating Temperature Range	Nominal Displacement (μm)	Maximum Voltage (VDC)	Generated Force (N)	Mount Configuration	Drive Block Configuration	New Design	Lead Type	Environmental Compliance
AH = Encapsulated in Metal Case, High Performance Type	B = Bellows (pre-load), maximum operating temperature of 85°C	The first two digits specify the displacement values. The last digit is an exponent of 10. Example: 170 = 17 μm	C = 150	The first two digits specify the values. The last digit is an exponent of 10. Example: 801 = 800 N = 80 kgf	N = Female thread type F = Flange type W = Without flange type	D = V groove	Sequentially numbered starting from zero.	Blank = Mounting type A0 = Straight attached leads	LF = RoHS/REACH Compliant (See "Environmental Compliance" below)

Application Examples

	Application Examples
Semiconductor manufacturing system	Positioning of stepper, clamping actuator of wire bonding, valve actuation of mass flow controller, actuator of shaker, actuator of damping system, positioning of light source
Precision machinery, mechatronics	Sewing machine, robot, vibration of parts feeder, positioning of equipment, pressure sensor
Home appliances	Actuator of pump
Optical equipment	Positioning of stage, actuator of autofocus, actuator of shaker and damping system
Communications	Polarization control, wavelength control
Medical equipment	Micropump, ultrasonic transducer, manipulators
Measuring instrument	Pressure sensor, acceleration sensor, fine positioning
Automotive	Vibration Control

Element Structure

KEMET's multilayer piezoelectric actuators are designed using unique element structure technology and proprietary ceramic materials with high electrostrictive factors.

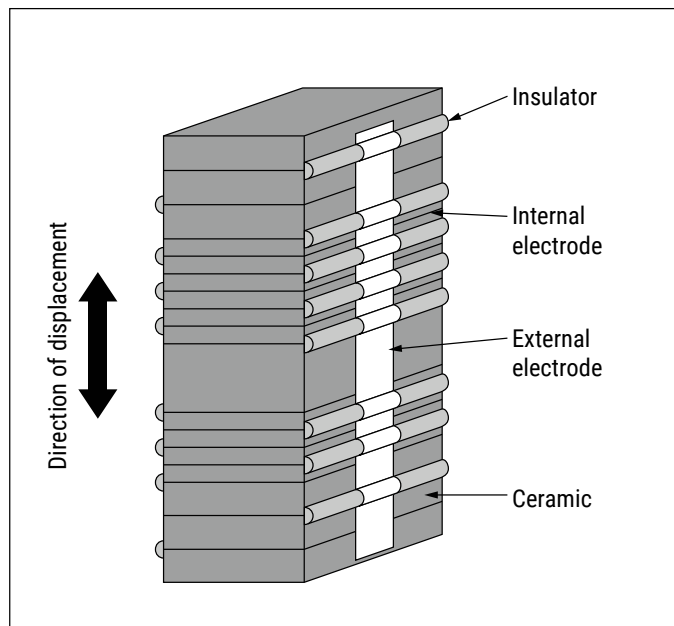

This particular structure and technology involved provide a unique product with below advantages compared to other similar solutions:

Against electromagnetic actuators

- Faster response
- Higher resolution for positioning
- Large generated force
- Low power consumption
- No electromagnetic noise

Against bimorph piezoelectric actuators

- 7 times the energy conversion efficiency of the bimorph type actuator
- Lower power consumption
- Large generated force
- Stable displacement, reduced shift and creep phenomena
- 100 times the response speed of the bimorph piezoelectric actuator

Against stacked piezoelectric actuators

- Compact size (less than 1/10 the specific volume of the stacked piezoelectric actuator)
- Low drive voltage
- Easy to use
- Inexpensive

Dimensions in mm

Female Thread Type

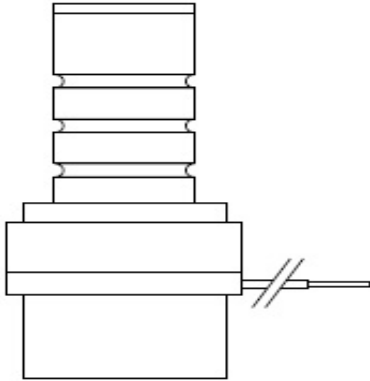

Part Number	L (mm)
AHB550C801ND0LF	58.4
AHB700C801ND0LF	78.4
AHB800C801ND0LF	78.4
AHB101C801ND0LF	98.4

Flange Type

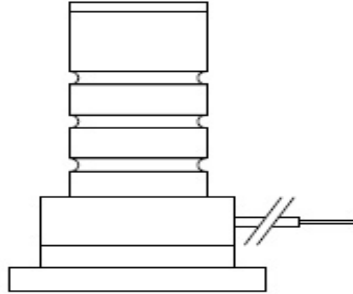

Part Number	L (mm)
AHB550C801FD0LF	52.4
AHB700C801FD0LF	72.4
AHB800C801FD0LF	72.4
AHB101C801FD0LF	92.4

Without Flange Type

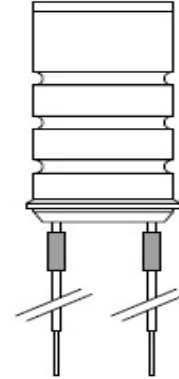

Part Number	L (mm)
AHB550C801WD1-A0LF	44.4
AHB700C801WD1-A0LF	64.4
AHB800C801WD1-A0LF	64.4
AHB101C801WD1-A0LF	84.4
AHB550C172WD1-A0LF	44.4
AHB550C302WD1-A0LF	44.4
AHB700C302WD1-A0LF	64.4
AHB101C302WD1-A0LF	84.4
AHB101C362WD1-A0LF	84.4
AHB151C362WD1-A0LF	125.4

Dimensions in mm cont.

AHB*C801ND0LF**

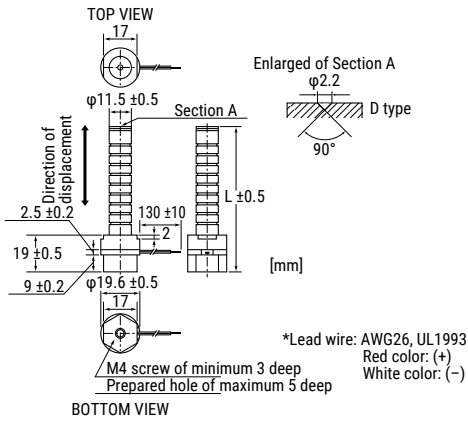

AHB*C801FD0LF**

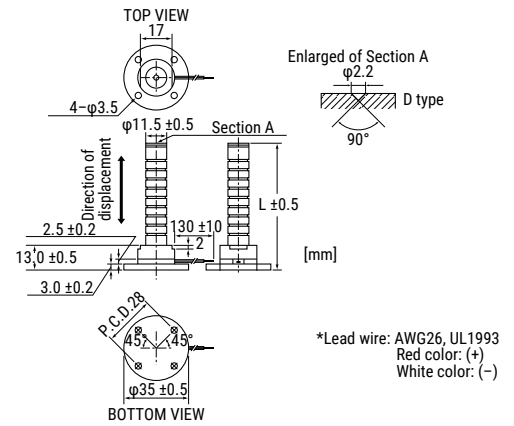

AHB*C302WD1-A0LF &
AHB***C362WD1-A0LF**

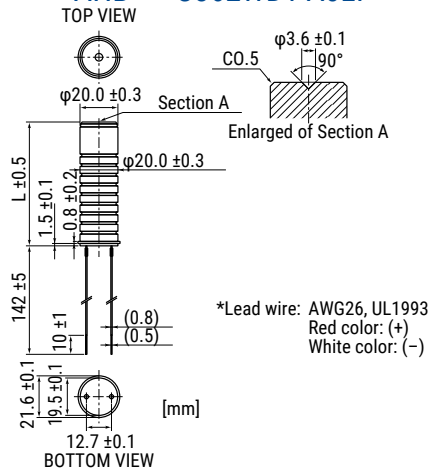

AHB*C801WD1-A0LF**

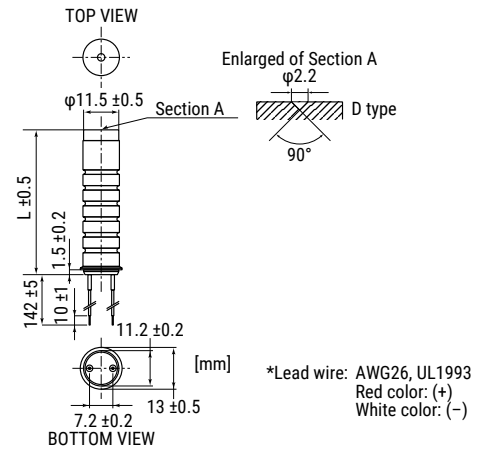

AHB550C172WD1-A0LF

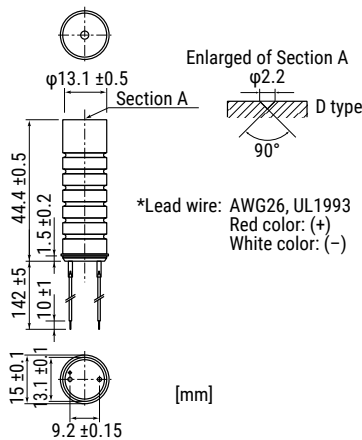

Performance Characteristics

Item	Performance Characteristics	Conditions
Operating Temperature Range	-25 to +85°C	When applied with a DC voltage at ambient temperature. When driven by an AC voltage at ambient temperature plus temperature rise due to heat generation.
Recommended Storage Condition	-5 to +40°C	
Maximum Driving Voltage	150 VDC	
Displacement	See Table 1 - Ratings & Part Number Reference	At 150 VDC
Generated Force (Compression Resistance)	See Table 1 - Ratings & Part Number Reference	The force required for restricting the displacement to zero when the maximum driving voltage is applied.
Capacitance	See Table 1 - Ratings & Part Number Reference	
Capacitance Tolerance	±20%	f = 1 kHz, V = 1 V _{rms} (< 10 μF) f = 120 Hz, V = 1 V _{rms} (> 10 μF)
Dissipation Factor	5% or less	
Insulation Resistance	See Table 1 - Ratings & Part Number Reference	Value obtained in one minute at 150 VDC.
Resonance Frequency	See Table 1 - Ratings & Part Number Reference	Both ends of the element are in free state. Typical values of the element under our test conditions.
Airtightness	1 X 10 ⁻⁸ atm cc/second or less	
Temperature Cycle Test	Displacement: Initial value ±30% Capacitance: Initial value ±30% tan δ: Less than initial rated value Insulation Resistance: 1 MΩ or more	Room temperature (3 minutes) At -25°C for 30 minutes Room temperature (3 minutes) At +85°C for 30 minutes Repetition of 10 cycles of the above
High Temperature Shelf Test	Displacement: Initial value ±30% Capacitance: Initial value ±30% tan δ: Less than initial rated value Insulation Resistance: 1 MΩ or more	Temperature: 85 ±2°C Time: 1,000 ±48 hours
Solvent Resistance Test	Displacement: Initial value ±30% Capacitance: Initial value ±30% tan δ: Less than initial rated value Insulation Resistance: 1 MΩ or more Appearance: No noticeable defect Mark: Easily legible	Solvent: Isopropyl alcohol Temperature: 23 ±5°C Time: Immersion for 1 minute
Heat Resistance Test	Displacement: Initial value ±30% Capacitance: Initial value ±30% tan δ: Less than initial rated value Insulation Resistance: 1 MΩ or more Appearance: No noticeable defect Mark: Easily legible	Temperature: 150 ±3°C Time: 96 ±4 hours

Environmental Compliance

All KEMET Multilayer Piezoelectric Actuators are RoHS and REACH Compliant.

Article 33(1) of the REACH Regulation states that manufacturers and importers of articles (products) are required to notify their customers of the presence of any Substances of Very High Concern (SVHC) in their products exceeding 0.1% by weight and provide instructions on safe use of the product.

KEMET Corporation reports regarding the Article 33(1) of REACH Regulation as follows:

1. Applicable Product:

Multilayer piezoelectric actuators (AE, ASB, ASL and AHB Series).

2. Report for content of REACH SVHC list:

The product(s) above contain a substance by more than 0.1wt% per product weight that was published in the 8th update of the REACH SVHC substances (December 19, 2012).

3. Regarding safety of the multilayer piezoelectric actuators (Piezoceramic products):

The Piezoceramic that is used in this product becomes ceramic by sintering powder containing PZT as a main ingredient. It is chemically stable, with minimum risks toward the human body or environment within the intended use of the product. Please note that risks could occur in the case of inhalation or accidental oral uptake of powder ceramics.

4. Technical product information on the multilayer piezoelectric actuators (Piezoceramic products):

The manufacturing technique of the “piezoceramic products” whose main ingredient is Lead Titanium Zirconium Oxide (PZT) has been established, and there is no alternative material that can exhibit superior performance than PZT at this moment. Please note that the piezoceramic is listed as an exempt on RoHS (2011/65/EU) Annex III (7c.1).

5. Responsibility of piezoceramic manufacturers:

Piezoceramic manufacturers report information regarding PZT containment in their products to the customers to obey the article 33 of the REACH regulation.



Table 1 – Ratings & Part Number Reference

Part Number	Electrical			Energy/Power		Physical	
	Capacitance (μF)	Resonance Frequency (kHz)	Insulation Resistance (MΩ)	Generated Force (N)	Displacement (μm) at Maximum Voltage of 150 VDC	Type	Weight (g)
AHB550C801ND0LF	6.4	12	10.0	800	55 ±8	Female Thread	50
AHB700C801ND0LF	8.2	8	5.0	800	70 ±15	Female Thread	56
AHB800C801ND0LF	9.3	8	5.0	800	80 ±15	Female Thread	56
AHB101C801ND0LF	11.0	8	5.0	800	103 ±15	Female Thread	61
AHB550C801FD0LF	6.4	12	10.0	800	55 ±8	Flange	54
AHB700C801FD0LF	8.2	8	5.0	800	70 ±15	Flange	60
AHB800C801FD0LF	9.3	8	5.0	800	80 ±15	Flange	60
AHB101C801FD0LF	11.0	8	5.0	800	103 ±15	Flange	65
AHB550C801WD1-A0LF	6.4	18	10.0	800	55 ±8	Without Flange	16
AHB700C801WD1-A0LF	8.2	10	5.0	800	70 ±15	Without Flange	22
AHB800C801WD1-A0LF	9.3	10	5.0	800	80 ±15	Without Flange	22
AHB101C801WD1-A0LF	11.0	9	5.0	800	103 ±15	Without Flange	27
AHB550C172WD1-A0LF	12.0	20	2.0	1,700	52 ±8	Without Flange	26
AHB550C302WD1-A0LF	26.0	18	2.0	3,000	52 ±8	Without Flange	55
AHB700C302WD1-A0LF	32.0	12	2.0	3,000	68 ±15	Without Flange	76
AHB101C302WD1-A0LF	44.0	9	1.0	3,000	95 ±15	Without Flange	91
AHB101C362WD1-A0LF	54.0	9	1.0	3,600	95 ±15	Without Flange	113
AHB151C362WD1-A0LF	85.0	7	0.5	3,600	140 ±18	Without Flange	154

Custom Design Parts

Customized parts are available on request. Please contact KEMET.

Below guidelines can be used as reference regarding generated displacement and generated force.

Item	Characteristics
Displacement	Roughly proportional to the length of the element
Generated Force	Roughly proportional to the sectional area of the element
Product Cross Section	1 x 1 mm square or larger
Product Length	1 mm or longer
Product Shape	Available in cylindrical ring or other shapes

Electrical Characteristics

ASL Series Performance Comparison with ASB Series

Figure 1 - Voltage vs. Displacement

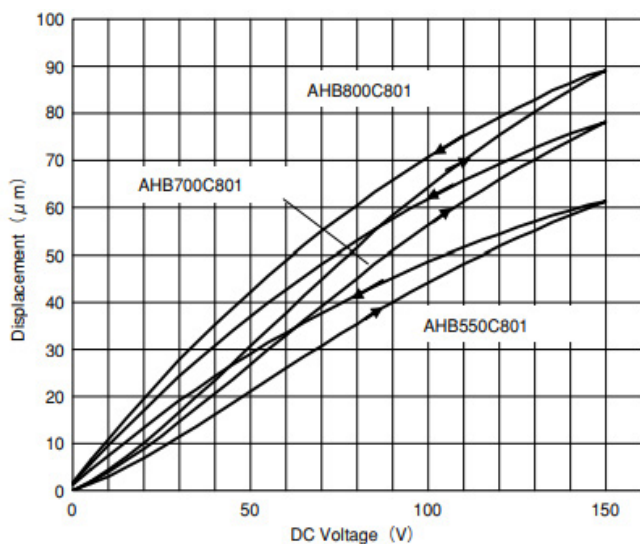

Figure 2 - Compression Load vs. Displacement

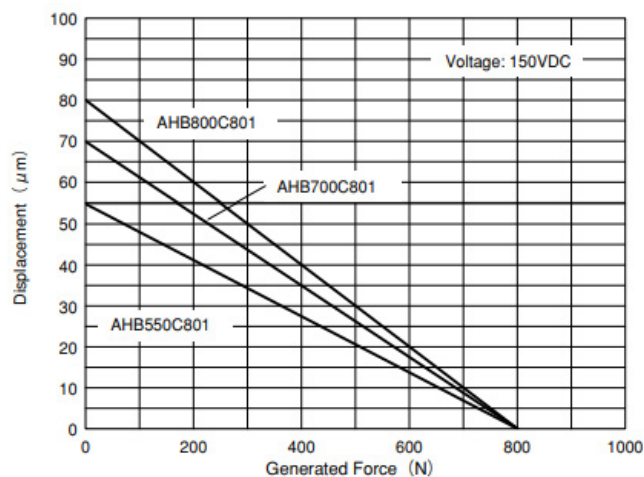
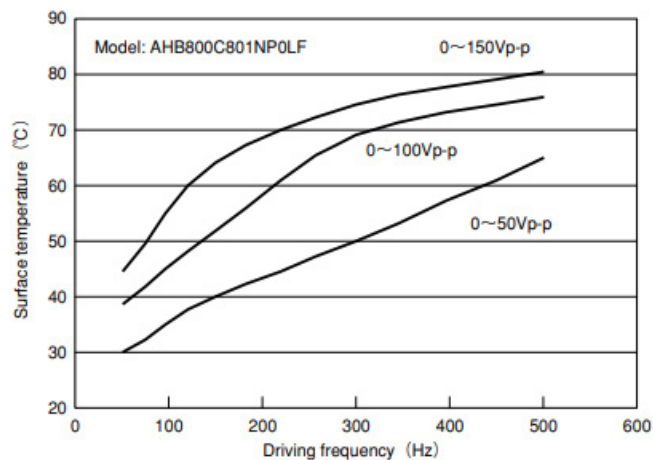

Figure 3 - Heat Generation vs. Drive Frequency



Notes:

* Driving waveform: SIN wave 0~Vp-p

* Temperature measurement: 10 minutes after the device is in operation

Electrical Characteristics cont.

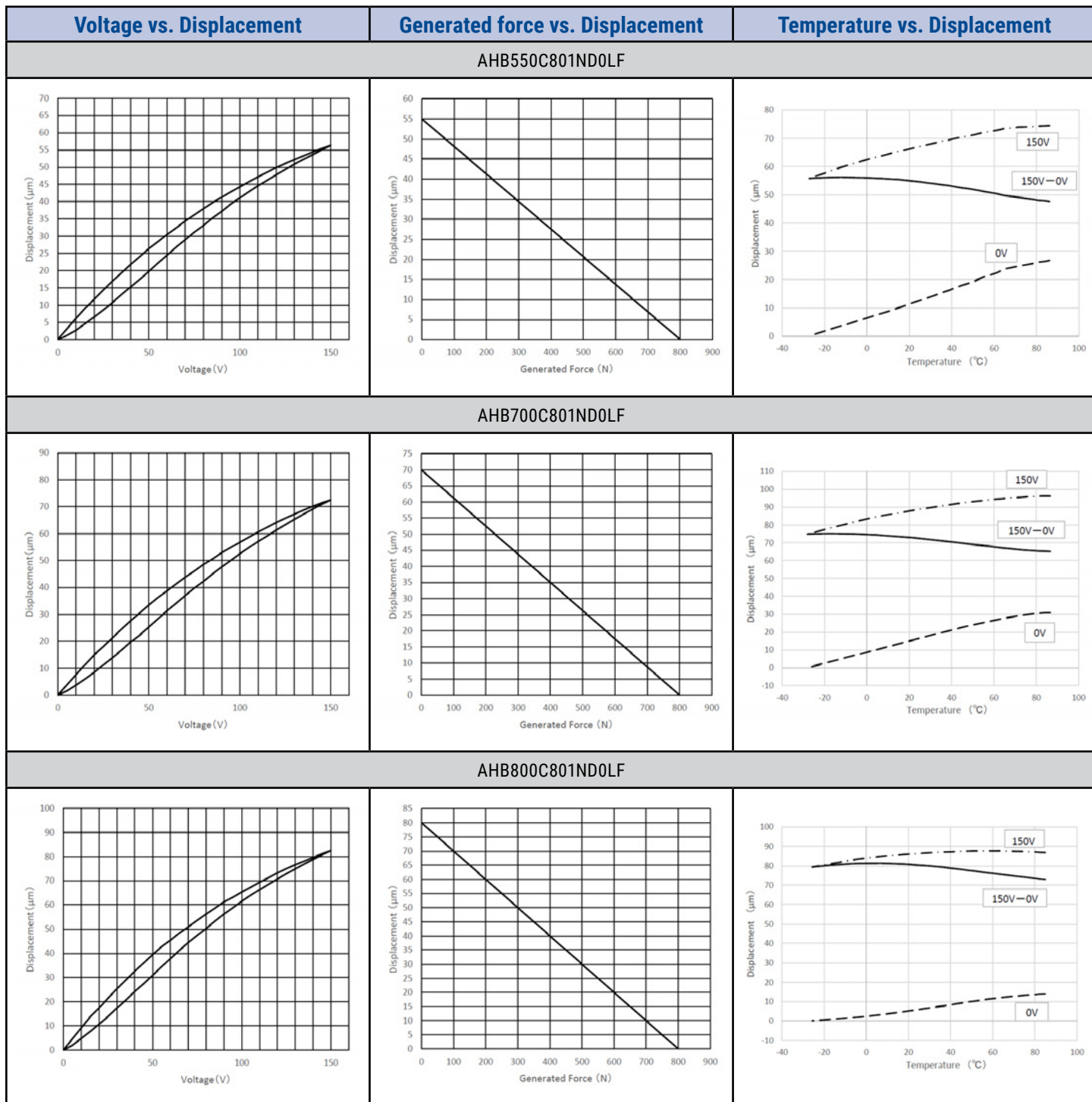

Electrical Characteristics cont.

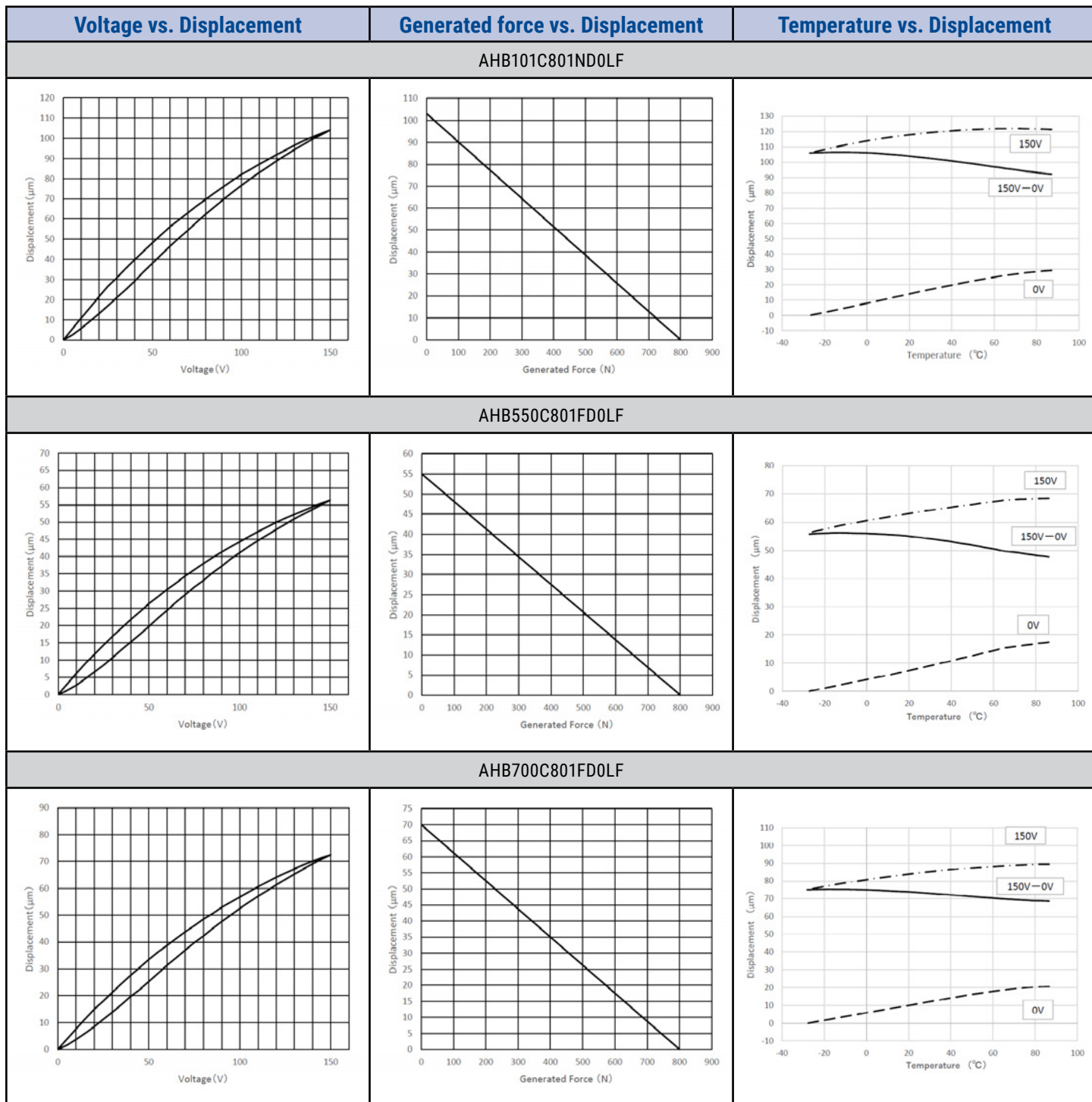

Electrical Characteristics cont.

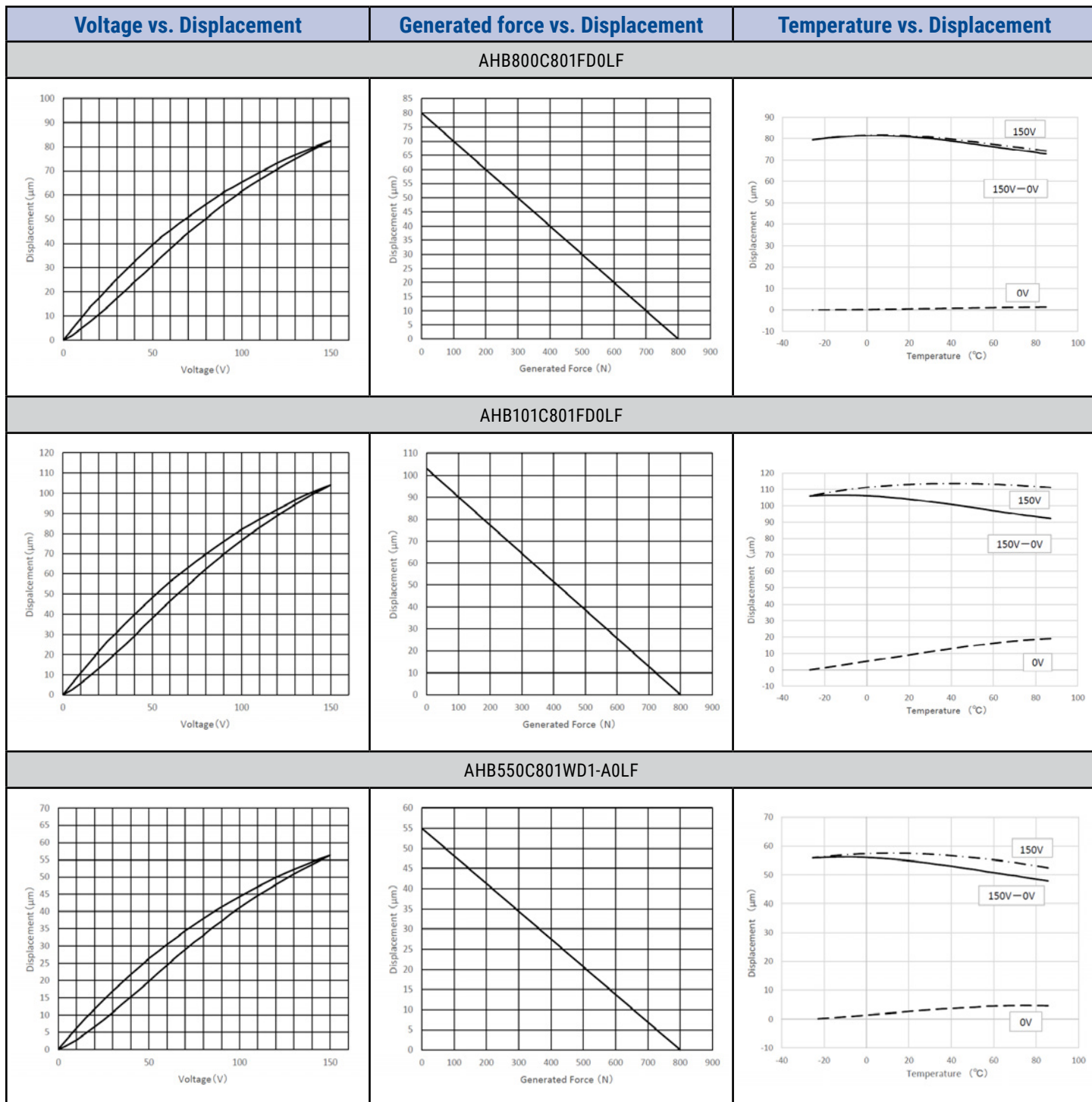

Electrical Characteristics cont.

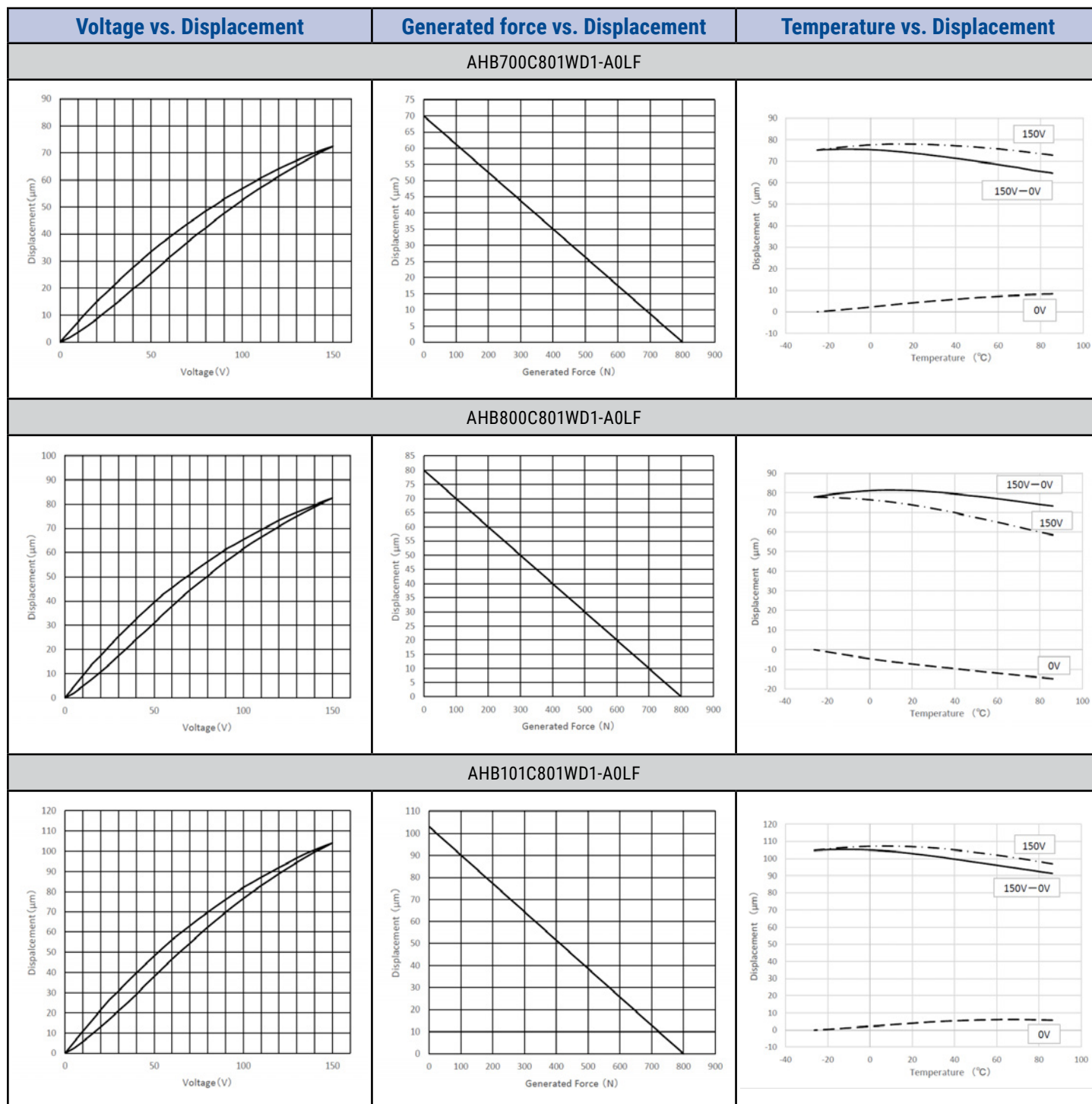

Electrical Characteristics cont.

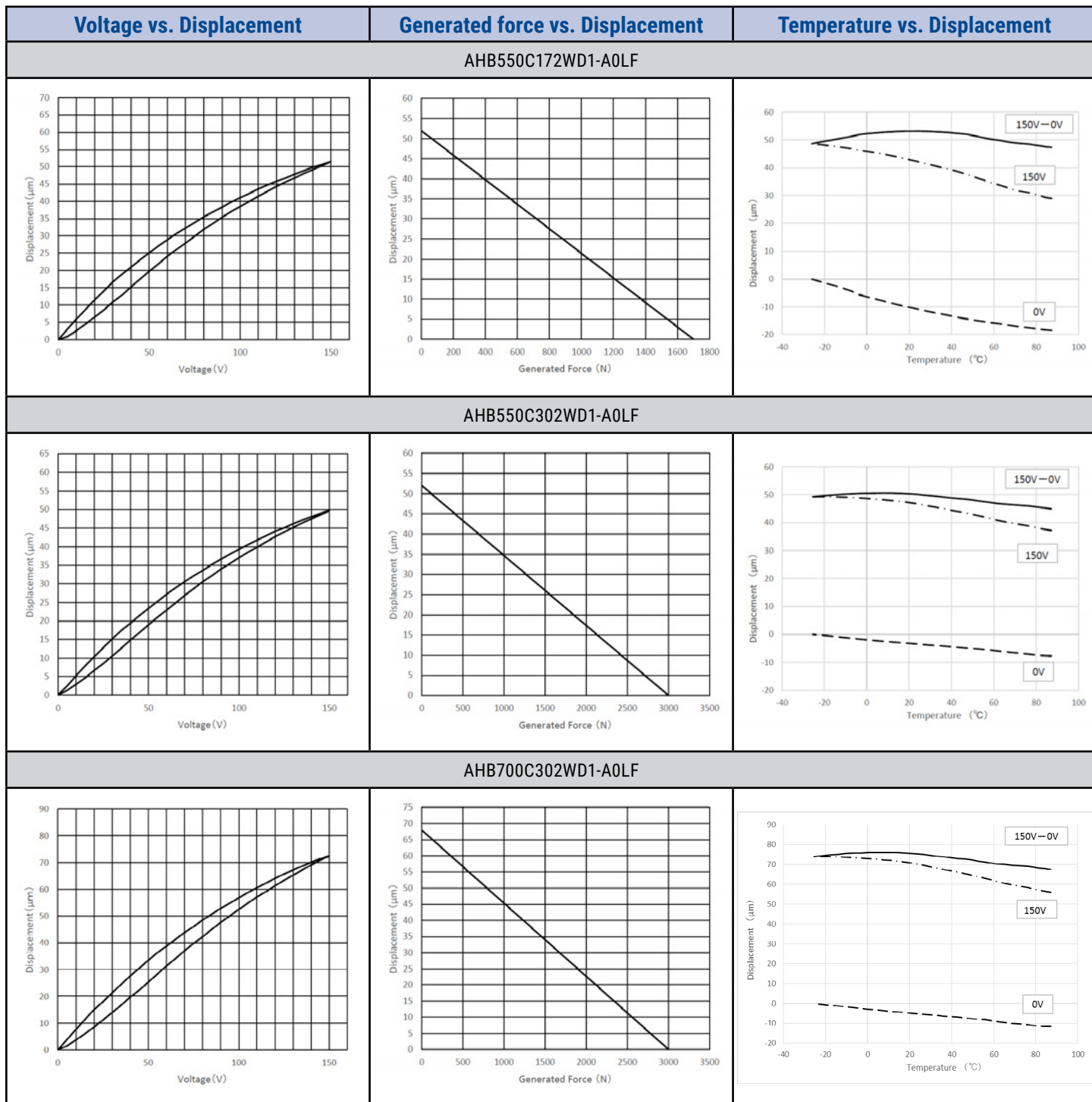

Electrical Characteristics cont.

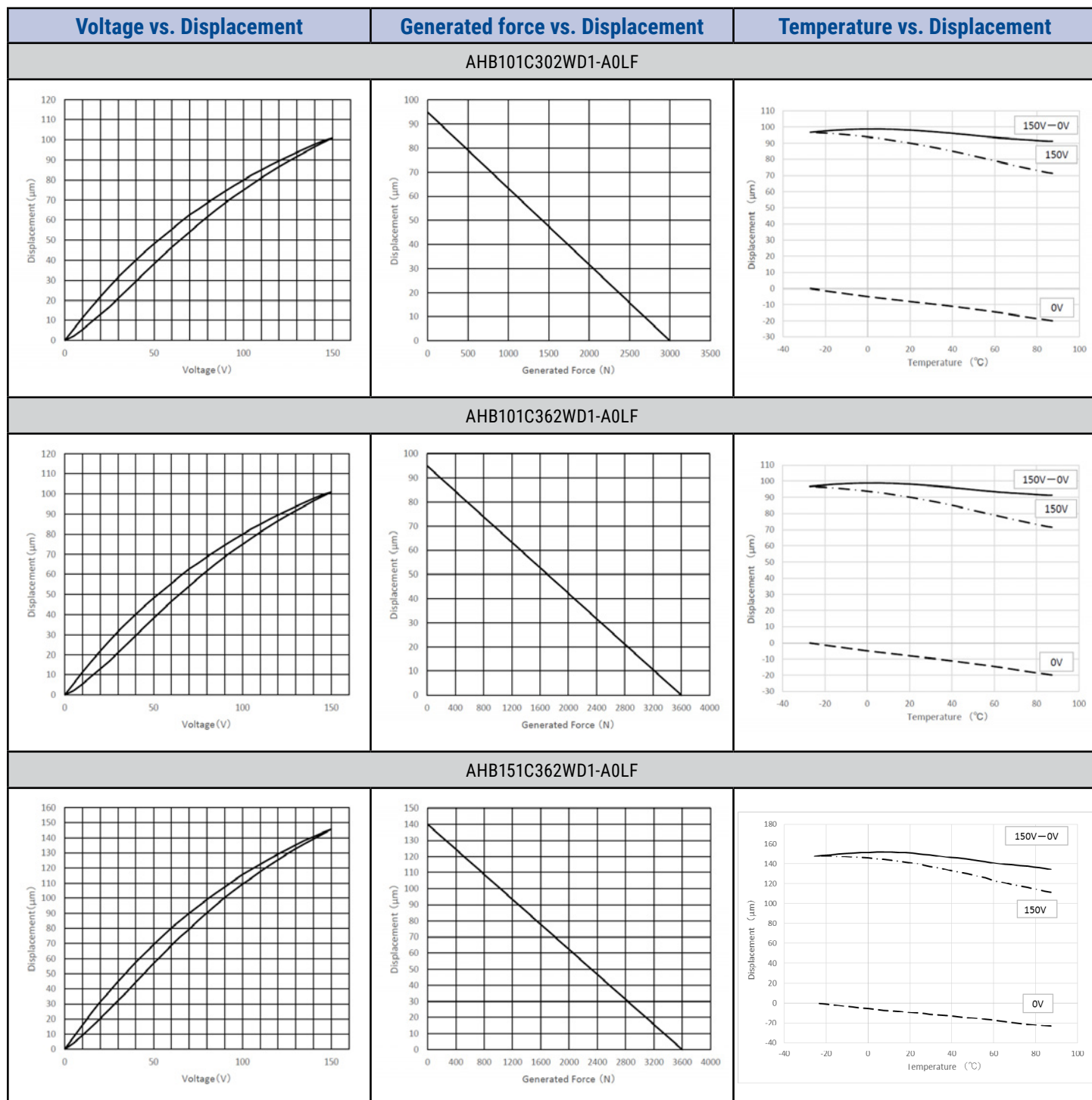

Packaging

Part Type	Packaging Type	Pieces per Box
AHB***ND0LF	Tray	1
AHB***FD0LF		
AHB***801WD1-A0LF		10
AHB***172WD1-A0LF	Bulk	1
AHB***302WD1-A0LF		
AHB***362WD1-A0LF		

Reliability

The majority of failure modes on multilayer piezoelectric actuators are short-circuits due to degraded insulation. Although the cause of degradation of insulation has not been clarified, it has been found that the failure rate varies greatly between static uses (DC voltage application) and dynamic uses (pulse voltage application). Like other electrical components, piezoelectric actuators can be affected by humidity as well as applied voltage and ambient temperature. KEMET has added the metal sealed piezoelectric actuators featuring high reliability by eliminating the effects of the ambient atmosphere.

This section describes reliability guidelines for static and dynamic usage of the metal sealed type actuators. Reliability of our multilayer piezoelectric actuators is represented by MTTF (mean time to failure) in case of static usage. The number of repetitions is considered to represent the reliability in the case of dynamic usage.

DC Voltage Application

MTTFR of the metal sealed type under the actual operating conditions is calculated from the reference MTTFs and the acceleration factor as it is in the case of the resin coated type. However, since the internal element is sealed from the atmosphere, it is not affected by the atmospheric humidity. Therefore, equation (1) below is used.

$$(1) \text{ MTTFR} = \text{MTTFs} \times A_v \times A_t$$

MTTFR : Estimated value

MTTFs : Reference value (= 36,000 hours)

A_v : Acceleration factor for drive voltage = $(100/V_R)^2$

A_t : Acceleration factor for ambient temperature = $1.5^{(85-T_R)/10}$

V_R : Actual voltage (V)

T_R : Actual ambient temperature (°C)

The following calculation is made for the case of use at 25°C and 150 V.

$$\begin{aligned} \text{MTTFR} &= 36,000 \times (100/150)^2 \times 1.5^{(85-25)} \\ &= 36,000 \times 0.44 \times 11.3 \\ &\approx 179,000 \text{ hours (20.4 years)} \end{aligned}$$

Reliability cont.

Pulse Voltage Application

Similarly to the resin coated type, it is extremely difficult to estimate reliability for the metal sealed type products by using an equation.

In KEMET's testing on the ASB170C801NP0, there was no failure confirmed up to 1,000 hours (equivalent to 100 million pulses applied) under the conditions below:

Temperature: 85 ±2°C

Humidity: 90 to 95% RH

Load: 200 N to 500 N (20 kgf to 50 kgf)

Drive voltage waveform: rectangular wave, 30 Hz, 0 to 100 V, duty ratio at 30%

User's Guide

Fixing Method

- Carefully prevent the piezoelectric actuators from being bent, twisted or applied tensile force.

Reference: Twisting and Tension Tolerance

	Reference Value	Remarks
Twisting Force	$3 \times 10^{-1} \text{ N} \cdot \text{m}$ or less	For an actuator which generates a force of 800 N (compression resistance).
Tension	50 N or less	

- Install the actuator so that the center axis of the generated displacement is aligned with the center axis of the load.
- Epoxy-based adhesives are recommended for bonding. Select adhesives that have high rigidity and allow for medium thickness so that the generation force and displacement cannot be deteriorated. Also, do not form adhesives on the side of the actuator.
- When thermosetting resin is used, perform polarizing treatment (see caution section) after the adhesive is settled.
- The resin coated type is weak to the tensile force due to its structure and may be broken when tensile forces are applied onto the device. Using the device in the state that constantly applies compression is effective against any mechanical damage. The pressure applied to this element should be kept at 20% to 50% of the force generated by this element (compression resistance).
- Install the element so that the axis of generated displacement is vertical to the mounting surface.

User's Guide cont.

Female Thread Type Fixing Method



Flange Type Fixing Method



Without Flange Type Fixing Method

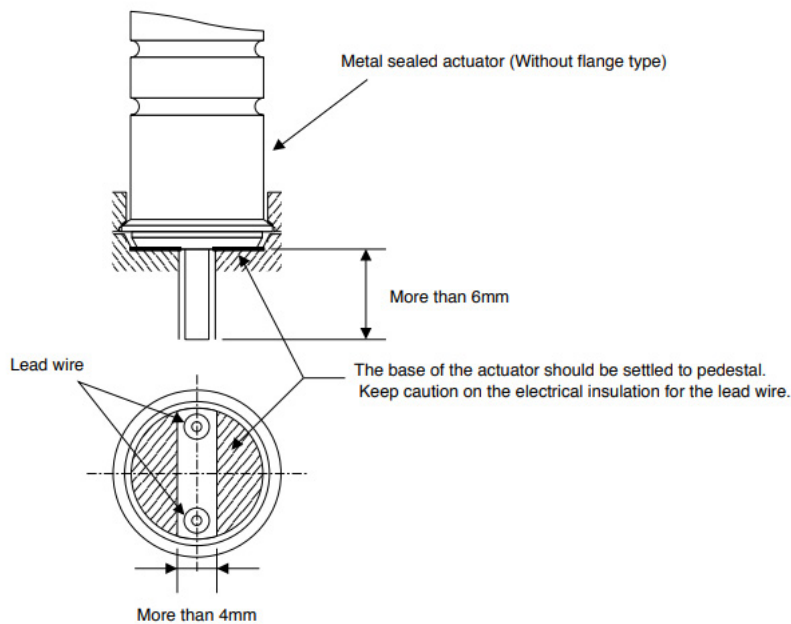

Driving Method

- Connect the red lead wire to the positive (+) terminal of the power supply. Also prevent reverse voltage application.
- In driving applications, it is necessary to take consideration of hysteresis, ringing, creep, and other similar phenomena.
- For pulse driving, it is also necessary to be aware of self-heat generation, charge/discharge current, and the power supply's impedance.

User's Guide cont.

Generated Force and Load Relation

Static load: No load value change when actuator moves.

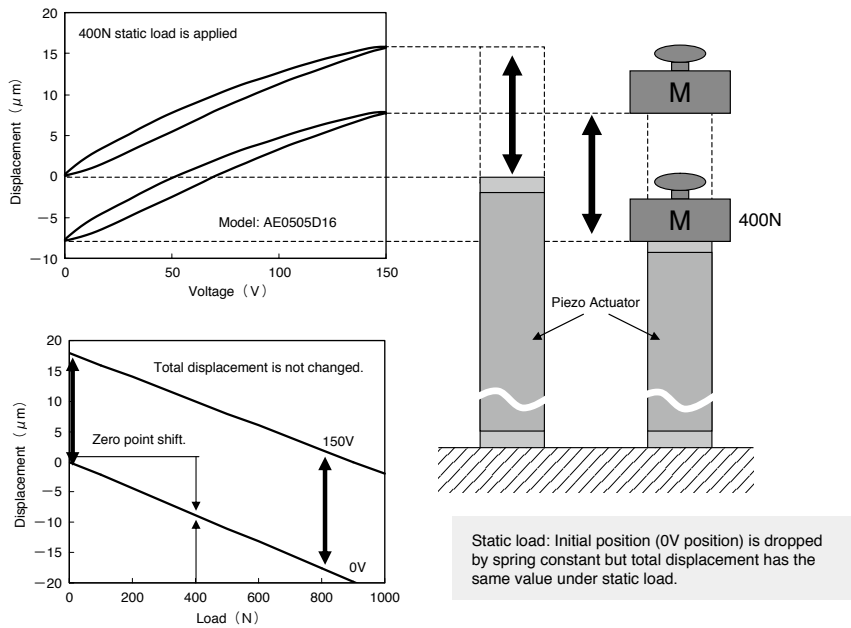

Fluctuating load: Load value changes by spring reaction when actuator moves.

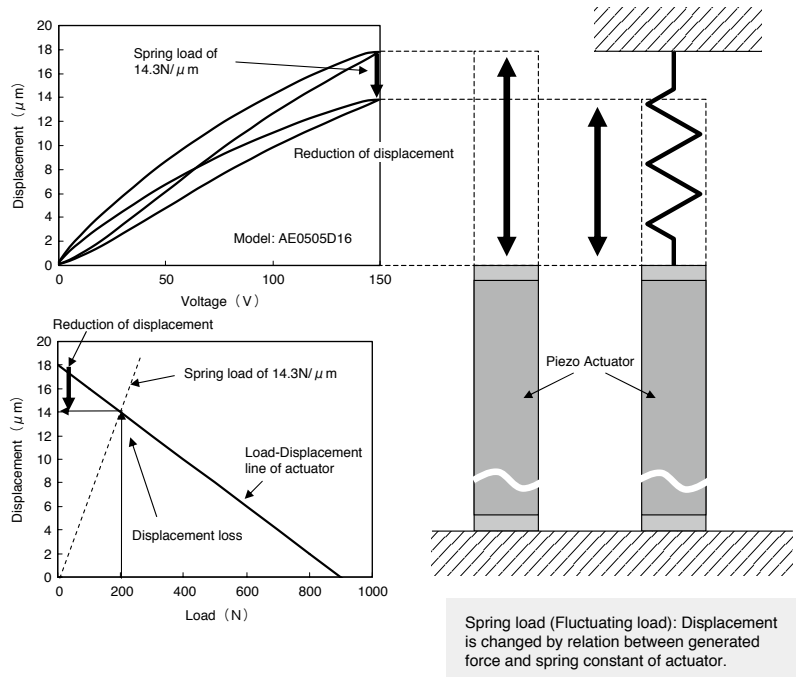

Handling Precautions

Precautions to be taken when using multilayer piezoelectric actuators (Please read these precautions before using our products)

1. Before using or designing a system using our products, read the precautions and specifications listed below.
2. The main failures with multilayer piezoelectric actuators are deterioration of insulation resistance, short-circuit, and open-circuit.
Before using the products, design systems should be designed carefully to ensure redundancy, prevention of the spread of fire, and prevention of faulty operation allowing for the occurrence of failures.
3. Use the products after checking the working conditions and rated performance of each multilayer piezoelectric actuator series.

Selection of AE series (resin coated type) or ASB, ASL or AHB Series (metal sealed type) should be based on the intended working temperature and humidity.

- Connect the red lead wire to the positive (+) terminal of the power supply.
- Avoid electric shocks since a high voltage is in use.
- Never apply excessive tension to a lead wire.
- Do not handle the product by picking up or moving the lead wire.
- Machining of the actuator element and replacement of the lead wire are prohibited.
- Do not handle the resin coated type (AE series) with bare hands.
- Do not wash the resin coated type (AE series) with organic solvents.
- Avoid excessive physical shock. Otherwise, the internal piezoelectric ceramic element may be damaged.
- If the actuator is exposed to high temperatures above 100°C or if used after long storage periods (more than three months), the device should be polarized by using the circuit configuration and conditions shown at right.
- Do not apply voltage exceeding maximum rating voltage, or rapid charging and discharging.
- Do not use the actuator in high concentrations of highly inflammable gas.
- Align the center axis of displacement of the actuator with the center axis of the mechanical load.
- When operated, the transient response time of the actuator should be less than 1/3 of the resonant frequency in order to prevent damage by ringing.
- Store the metal sealed type preferably in a dry atmosphere (desirably below 40% RH) at ordinary temperatures (-5°C to +40°C). Avoid condensation on the product's surface.
- Store actuators where there is no vibration.
- Handle products properly as industrial waste. When disposing, please contact your local waste disposal service and make sure the disposal methods meet all legal requirements.

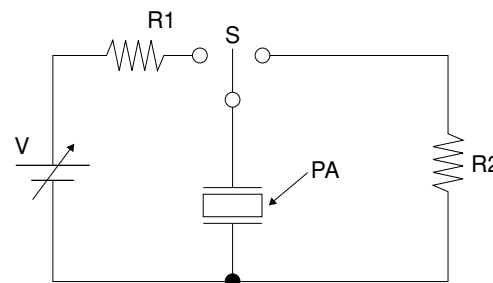

Protective resistor R1=1kΩ
Protective resistor R2=1kΩ
Polarizing conditions: DC voltage application
0V→150±0.2V (to be retained for 10 seconds) →0

Export Control

For customers in Japan

For products which are controlled items subject to the “Foreign Exchange and Foreign Trade Law” of Japan, the export license specified by the law is required for export.

For customers outside Japan

Multilayer Piezoelectric Actuators should not be used or sold for use in the development, production, stockpiling or utilization of any conventional weapons or mass-destructive weapons (nuclear weapons, chemical or biological weapons, or missiles), or any other weapons.