

Auxiliary Contact Units

- 2 and 4 pole
- Side or front mountable
- Common use for Metasol contactors from CC9 to CC150

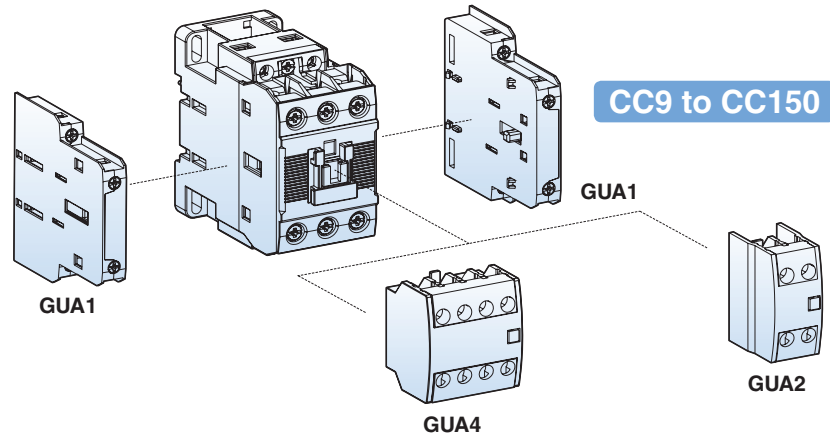
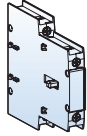
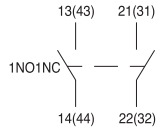
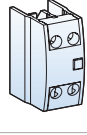
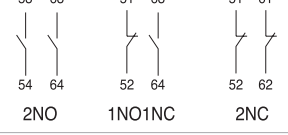
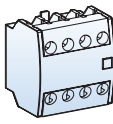
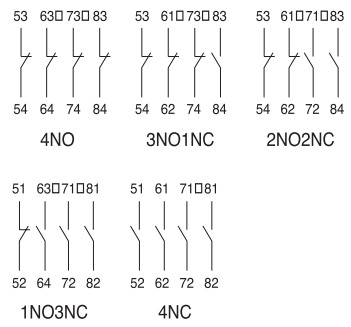

Selection

Type	Appearance	Pole	Composition		Contact arrangement	Mount	Weight
			NO	NC			
GUA1		2	1	1		Side	53g
GUA2		2	2 1 -	- 1 2		Front	28g
GUA4		4	4 3 2 1 -	- 1 2 3 4		Front	50g

Maximum Combination of Contact Units

For contactors with AC coils	For contactors with DC coils
GUA4 (on front) + GUA1 × 4EA (2EA on both sides)	GUA4 (on front) + GUA1 × 2EA (1EA on both sides)
GUA2 (on front) + GUA1 × 4EA (2EA on both sides)	GUA2 (on front) + GUA1 × 2EA (1EA on both sides)

Auxiliary contact units

Rating

Type		GUA1	GUA2, 4	AUX100-11
Rated operation voltage (Ue)		600V	600V	600V
Rated insulation voltage (Ui)		600V	600V	600V
Rated impulse withstand voltage (Uimp)		6kV	6kV	6kV
Rated frequency		50/60Hz	50/60Hz	50/60Hz
Contact sensibility				
Voltage		DC 17V	DC 24V	DC 24V
Current		DC 5mA	DC 10mA	DC 10mA
Rated thermal current (Ith, AC12 duty)		10A	16A	16A
Rated operation current				
AC15 duty	120V	6A	6A	6A
(A600)	240V	3A	3A	3A
	380V	1.9A	1.9A	1.9A
	480V	1.5A	1.5A	1.5A
	500V	1.4A	1.4A	1.4A
	600V	1.2A	1.2A	1.2A
DC13 duty	125V	1.1A	1.1A	1.1A
(P600)	250V	0.55A	0.55A	0.55A
	400V	0.31A	0.31A	0.31A
	500V	0.27A	0.27A	0.27A
	600V	0.2A	0.2A	0.2A
Electrical lifetime (mil. operations)				
AC15 duty	220V	0.5	0.5	0.5
	440V	0.5	0.5	0.5
DC13 duty	220V	0.5	0.5	0.5
	440V	0.5	0.5	0.5
Maximum operating cycles per hour		1800	1800	1800
Conductor size (Solid, stranded)	AWG	18~10	18~10	18~10
(the max. number of conducts: 2)	mm ²	1~2.5	1~2.5	1~2.5

Installation

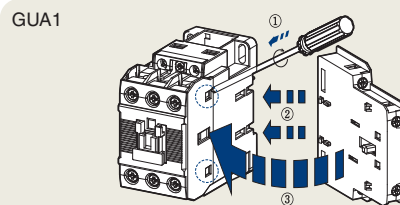

To install side mounting unit remove the indicated part in the circle in the fig. first. And then fit each part as shown. To separate push forward and pull.

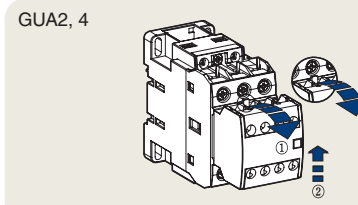

To install front mounting unit fit it on the upper part of the front of the contactor and push it down. To separate pull the lever of the unit and push the unit upward.

Contactor Accessories

Terminal Cover Units for Contactors

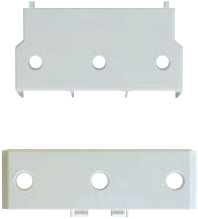

Applying contactors	Type	Remarks
MC-185a, 225a (225AF)	AP-220	2 pcs included
MC-265a, 330a, 400a (400AF)	AP-400	
MC-500a, 630a, 800a (800AF)	AP-800	

Insulation Barrier Units



Applying contactors	Type	Remarks
MC-185a, 225a (225AF)	AI-400	4 pcs required per contactor
MC-265a, 330a, 400a (400AF)		
MC-500a, 630a, 800a (800AF)	AI-800	

Interlocks

Component parts for assembling by customer

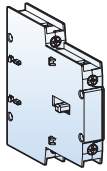

Interlock unit

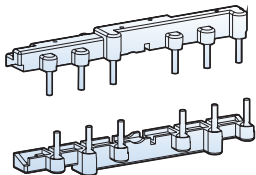

Wire kit

Interlock Unit, GUR02

GUR02 is a mechanical interlock unit and provides 2NC contacts for use in electrical interlocking

Wire Kit, UW

UW is used for making reversing circuit between two contactors.

Contactor	Wire kit		Interlock unit	
	Type	Weight	Type	Weight
CC9 ~ CC22	GUW22	0.04kg	GUR02	0.06kg
CC32 ~ CC40	GUW32	0.05kg		
CC50 ~ CC65	GUW63	0.12kg		
CC75 ~ CC100	GUW95	0.33kg		

Rating of the Contacts in the Interlocks

Rated operation voltage	600V	
Rated insulation voltage	600V	
Rated frequency	50/60Hz	
Rated thermal current	10A	
Rated operation current		
AC15 duty	120V	6A
(A600)	240V	3A
	380V	1.9A
	480V	1.5A
	500V	1.4A
	600V	1.2A
DC13 duty	125V	0.55A
	250V	0.27A

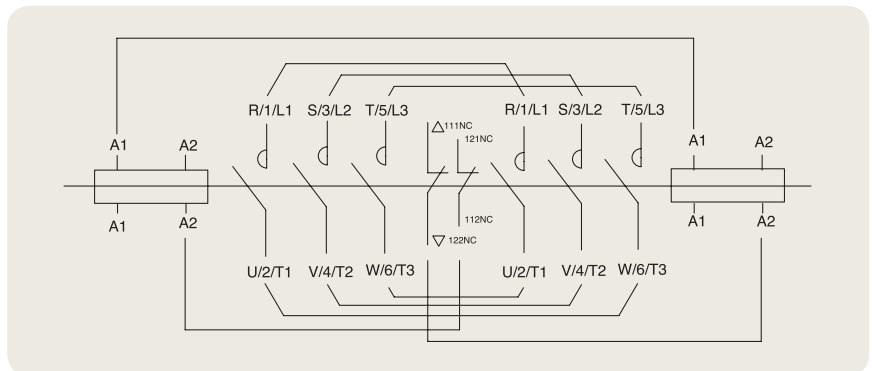
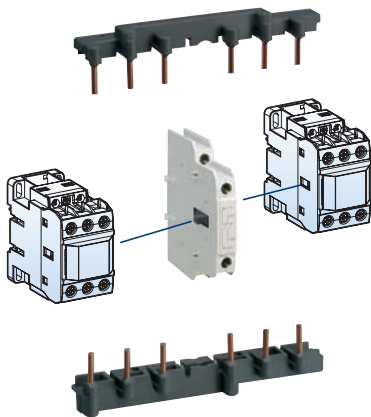

Typical circuit diagram for reversing contactor

Contactor Accessories



AR-180

Interlock Unit, AR-180 and AR-800

AR-180 and AR-800 are mechanical interlock units in which electrical contacts for use in electrical interlocking are not included. Please use the auxiliary contacts on the sides of the contactors for that purpose.

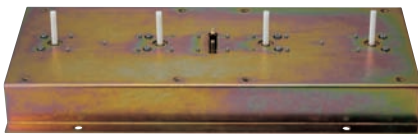

AR-600

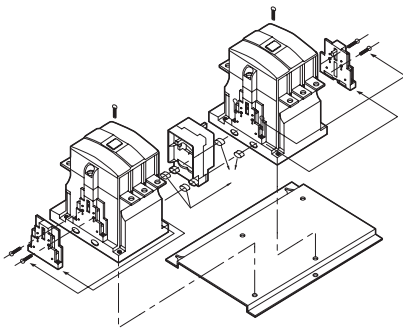

Contactor	Interlock unit	
	Type	Weight
CC180 CC225 CC265 CC330 CC400	AR-180	0.09kg
CC500 CC630 CC800	AR-800	15.2kg

Installation of Interlock and Wire Kits

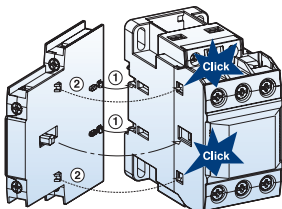

Install the interlock unit on the side of a contactor first. Fit each part as indicated in the fig.

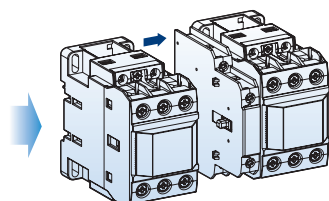

And then install the other contactor on the other side of the interlock unit as shown.

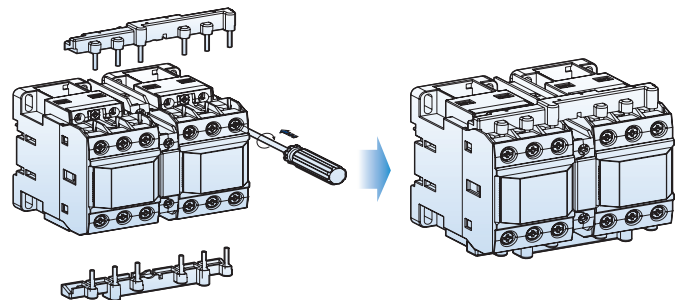

After installing interlock unit wiring kit can be assembled. Wiring kit contains two molded wires - one for line side and the other for load side.

Contactor Accessories

Surge Unit

It absorbs the surge arisen out of the coil of the contactor.
It can be installed simply to the contactor.

- Rated operation voltage (Ue): AC 24 ~ 440V
DC 24 ~ 125V
- Rated insulation voltage (Ui): 1000V
- Rated impulse withstand voltage (Uimp): 8kV
- Degree of protection: IP20

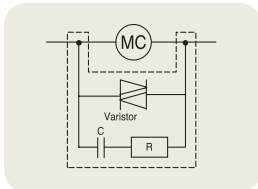

US-1~6

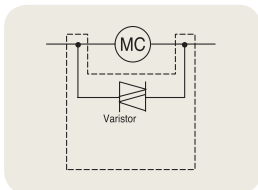

US-11~14

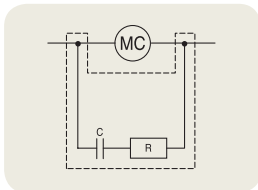

US-22

Surge unit		Rated voltage		Internal elements spec.			Weight
Type	Composition			V	R	C	
GUS1	Varistor+RC	AC	24~48V	120V	100 Ω	0.1 μF	29g
GUS2	Varistor+RC		100~125V	270V	100 Ω	0.1 μF	
GUS3	Varistor+RC		200~240V	470V	100 Ω	0.1 μF	
GUS4	Varistor+RC	DC	24~48V	120V	100 Ω	0.47 μF	
GUS5	Varistor+RC		100~125V	270V	100 Ω	0.47 μF	
GUS6	Varistor+RC		200~220V	470V	100 Ω	0.47 μF	
GUS11	Varistor	AC/DC common	24~48V	120V	-	-	
GUS12	Varistor		100~125V	270V	-	-	
GUS13	Varistor		200~240V	470V	-	-	
GUS14	Varistor		380~440V	1000V	-	-	
GUS22	RC	AC	100~125V	-	56 Ω	1 μF	

Installation

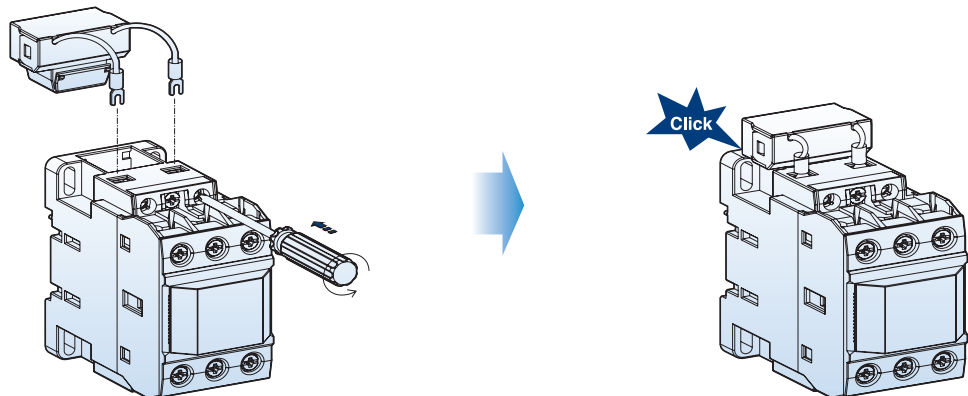

Connect the lead wires to the coil terminals of the contactor first.
And then insert the body into the space of the contactor as shown above.

Capacitor Unit

Capacitor unit is connected to the terminals of the contactor to reduce the high inrush current.



Type	Contactor	Maximum operating power (kvar)			Rated current (A)
		220 ~ 240V	400 ~ 440V	500 ~ 550V	
AC9	CC9	5	9,7	14	14
	CC12	6,7	12,5	18	18
	CC18	8,5	16,7	24	24
	CC22	10	18	26	26
	CC32	15	25	36	36
	CC40	20	33,3	48	48
AC50	CC50	20	40	58	58
	CC65	25	45,7	66	66
	CC75	29,7	54	78	78
	CC85	35	60	92	92
	CC100	37	62	94	94

Note) - When the switch is closed condenser must be discharged before recharged. (Maximum residual voltage at terminals $\leq 50V$)
 prevent short current, gG type fuse must be 1.5-2 times than rated current

Features of Capacitor Unit (Pre-loading Resistor)

- Damping resistor that can limit the inrush current upto $60 \times I_n$ is connected to the mechanism that closed earlier than the main contact of the contactor
- No heat loss by the serial resistor
- Eliminate the switching surge
- Improving the performance of the capacitor system

Operation Sequence

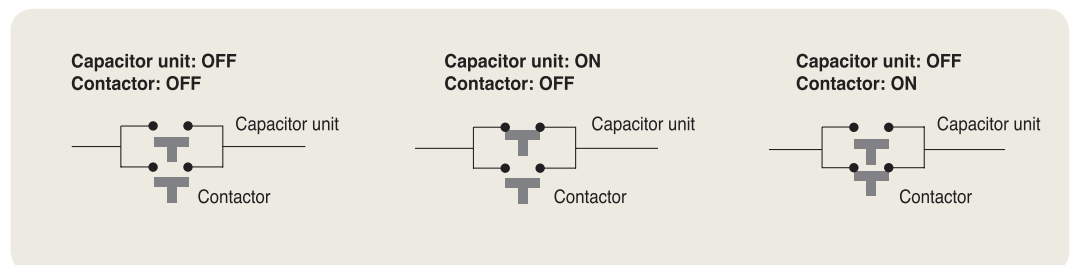

Note) Closing sequence: Fig.1 \Rightarrow Fig.2 \Rightarrow Fig.3
 Opening sequence: Fig.3 \Rightarrow Fig.1

Contactors Accessories

Replacement Coils

To replace the existing coil to change voltage or repair.



Contactor	Coil voltage							
	AC coil						DC coil	
	AC 60Hz (V)		AC 50Hz (V)		AC 50/60Hz (V)		DC (V)	
CC9 CC12 CC18 CC22	24	230	24	230	24	240	12	110
	48	240	36	240	48	380	20	125
	100	277	42	380	100	415	24	200
	110	380	48	400	110	440	48	220
	120	440	80	415	120	500	60	250
	200	480	100	440	200	550	80	
	208	600	110	500	220		100	
220		220	550	230				
CC32 CC40	24	230	24	230	24	240	12	110
	48	240	36	240	48	380	20	125
	100	277	42	380	100	415	24	200
	110	380	48	400	110	440	48	220
	120	440	80	415	120	500	60	250
	200	480	100	440	200	550	80	
	208	600	110	500	220		100	
220		220	550	230				
CC50 CC65	24	230	24	230	24	240	12	110
	48	240	36	240	48	380	20	125
	100	277	42	380	100	415	24	200
	110	380	48	400	110	440	48	220
	120	440	80	415	120	500	60	250
	200	480	100	440	200	550	80	
	208	600	110	500	220		100	
220		220	550	230				
CC75 CC85 CC100	24	230	24	230	24	240	12	110
	48	240	36	240	48	380	20	125
	100	277	42	380	100	415	24	200
	110	380	48	400	110	440	48	220
	120	440	80	415	120	500	60	250
	200	480	100	440	200	550	80	
	208	600	110	500	220		100	
220		220	550	230				
CC130 CC150					24	300	24	110
					48	400	48	220
					110	500		
					220			

Replacement Process

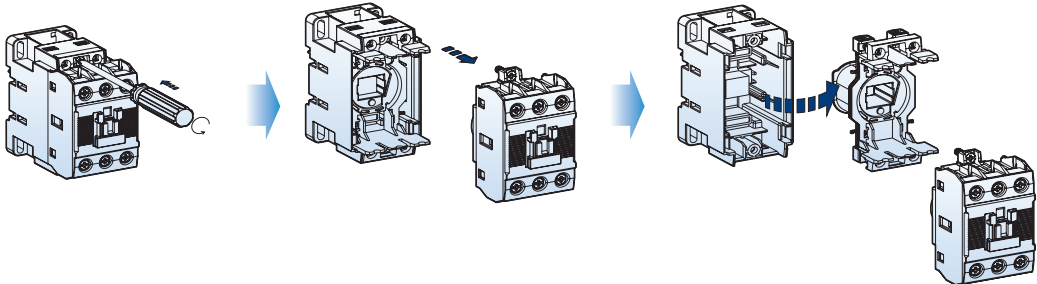

To instantly view a data sheet and specify products, visit www.GavazziOnline.com