

High speed switching series fifth generation

High speed fast IGBT in TRENCHSTOP™ 5 technology copacked with RAPID 1 fast and soft anti-parallel diode

Features and Benefits:

- High speed F5 technology offering:
- Best-in-Class efficiency in hard switching and resonant topologies
 - 650V breakdown voltage
 - Low gate charge Q_G
 - IGBT copacked with RAPID 1 fast and soft antiparallel diode
 - Maximum junction temperature 175°C
 - Dynamically stress tested
 - Qualified according to AEC-Q101
 - Green package (RoHS compliant)
 - Complete product spectrum and PSpice Models:
<http://www.infineon.com/igbt/>

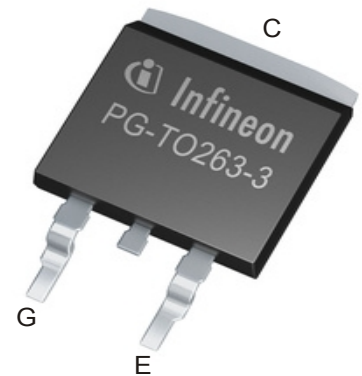

Applications:

- Off-board charger
- On-board charger
- DC/DC converter
- Power-Factor correction

Package pin definition:

- Pin 1 - gate
- Pin 2 & backside - collector
- Pin 3 - emitter



Key Performance and Package Parameters

Type	V_{CE}	I_C	$V_{CEsat}, T_{vj}=25^{\circ}C$	T_{vjmax}	Marking	Package
AIKB15N65DF5	650V	15A	1.6V	175°C	AK15EDF5	PG-TO263-3



Table of Contents

Description 1

Table of Contents 2

Maximum Ratings 3

Thermal Resistance 3

Electrical Characteristics 4

Electrical Characteristics Diagrams 7

Package Drawing13

Testing Conditions14

Revision History15

Disclaimer16

High speed switching series fifth generation

Maximum Ratings

Parameter	Symbol	Value	Unit
Collector-emitter voltage, $T_{vj} \geq 25^{\circ}\text{C}$	V_{CE}	650	V
DC collector current, limited by T_{vjmax} $T_c = 25^{\circ}\text{C}$ $T_c = 100^{\circ}\text{C}$	I_C	30.0 18.0	A
Pulsed collector current, t_p limited by $T_{vjmax}^{1)}$	I_{Cpuls}	45.0	A
Turn off safe operating area $V_{CE} \leq 650\text{V}$, $T_{vj} \leq 175^{\circ}\text{C}$, $t_p = 1\mu\text{s}^{1)}$	-	45.0	A
Diode forward current, limited by T_{vjmax} $T_c = 25^{\circ}\text{C}$ $T_c = 100^{\circ}\text{C}$	I_F	32.0 17.0	A
Diode pulsed current, t_p limited by $T_{vjmax}^{1)}$	I_{Fpuls}	45.0	A
Gate-emitter voltage Transient Gate-emitter voltage ($t_p \leq 10\mu\text{s}$, $D < 0.010$)	V_{GE}	± 20 ± 30	V
Power dissipation $T_c = 25^{\circ}\text{C}$ Power dissipation $T_c = 100^{\circ}\text{C}$	P_{tot}	105.0 52.5	W
Operating junction temperature	T_{vj}	-40...+175	$^{\circ}\text{C}$
Storage temperature	T_{stg}	-55...+150	$^{\circ}\text{C}$
Soldering temperature, reflow soldering (MSL1 according to JEDEC J-STA-020)		260	$^{\circ}\text{C}$

Thermal Resistance

Parameter	Symbol	Conditions	Value			Unit
			min.	typ.	max.	
R_{th} Characteristics						
IGBT thermal resistance, junction - case	$R_{th(j-c)}$		-	-	1.40	K/W
Diode thermal resistance, junction - case	$R_{th(j-c)}$		-	-	2.40	K/W
Thermal resistance, min. footprint junction - ambient	$R_{th(j-a)}$		-	-	65	K/W
Thermal resistance, 6cm ² Cu on PCB junction - ambient	$R_{th(j-a)}$		-	-	40	K/W

¹⁾ Defined by design. Not subject to production test.

High speed switching series fifth generation

Electrical Characteristic, at $T_{vj} = 25^{\circ}\text{C}$, unless otherwise specified

Parameter	Symbol	Conditions	Value			Unit
			min.	typ.	max.	
Static Characteristic						
Collector-emitter breakdown voltage	$V_{(BR)CES}$	$V_{GE} = 0\text{V}, I_C = 0.20\text{mA}$	650	-	-	V
Collector-emitter saturation voltage	V_{CESat}	$V_{GE} = 15.0\text{V}, I_C = 15.0\text{A}$ $T_{vj} = 25^{\circ}\text{C}$ $T_{vj} = 125^{\circ}\text{C}$ $T_{vj} = 175^{\circ}\text{C}$	-	1.60	2.10	V
			-	1.80	-	
			-	1.90	-	
Diode forward voltage	V_F	$V_{GE} = 0\text{V}, I_F = 9.0\text{A}$ $T_{vj} = 25^{\circ}\text{C}$ $T_{vj} = 125^{\circ}\text{C}$ $T_{vj} = 175^{\circ}\text{C}$	-	1.45	1.80	V
			-	1.40	-	
			-	1.40	-	
Gate-emitter threshold voltage	$V_{GE(th)}$	$I_C = 0.15\text{mA}, V_{CE} = V_{GE}$	3.2	4.0	4.8	V
Zero gate voltage collector current	I_{CES}	$V_{CE} = 650\text{V}, V_{GE} = 0\text{V}$ $T_{vj} = 25^{\circ}\text{C}$ $T_{vj} = 175^{\circ}\text{C}$	-	-	40	μA
			-	1000	-	
Gate-emitter leakage current	I_{GES}	$V_{CE} = 0\text{V}, V_{GE} = 20\text{V}$	-	-	100	nA
Transconductance	g_{fs}	$V_{CE} = 20\text{V}, I_C = 15.0\text{A}$	-	15.0	-	S

Electrical Characteristic, at $T_{vj} = 25^{\circ}\text{C}$, unless otherwise specified

Parameter	Symbol	Conditions	Value			Unit
			min.	typ.	max.	
Dynamic Characteristic						
Input capacitance	C_{ies}	$V_{CE} = 25\text{V}, V_{GE} = 0\text{V}, f = 1\text{MHz}$	-	930	-	pF
Output capacitance	C_{oes}		-	24	-	
Reverse transfer capacitance	C_{res}		-	4	-	
Gate charge	Q_G	$V_{CC} = 520\text{V}, I_C = 15.0\text{A},$ $V_{GE} = 15\text{V}$	-	38.0	-	nC
Internal emitter inductance measured 5mm (0.197 in.) from case	L_E		-	7.0	-	nH

Switching Characteristic, Inductive Load

Parameter	Symbol	Conditions	Value			Unit
			min.	typ.	max.	

IGBT Characteristic, at $T_{vj} = 25^{\circ}\text{C}$

Turn-on delay time	$t_{d(on)}$	$T_{vj} = 25^{\circ}\text{C},$ $V_{CC} = 400\text{V}, I_C = 7.5\text{A},$ $V_{GE} = 0.0/15.0\text{V},$ $R_{G(on)} = 39.0\Omega, R_{G(off)} = 39.0\Omega,$ $L_{\sigma} = 30\text{nH}, C_{\sigma} = 30\text{pF}$ L_{σ}, C_{σ} from Fig. E Energy losses include "tail" and diode reverse recovery.	-	23	-	ns
Rise time	t_r		-	13	-	ns
Turn-off delay time	$t_{d(off)}$		-	157	-	ns
Fall time	t_f		-	22	-	ns
Turn-on energy	E_{on}		-	0.16	-	mJ
Turn-off energy	E_{off}		-	0.04	-	mJ
Total switching energy	E_{ts}		-	0.20	-	mJ

High speed switching series fifth generation

Turn-on delay time	$t_{d(on)}$	$T_{vj} = 25^{\circ}\text{C}$, $V_{CC} = 400\text{V}$, $I_C = 2.0\text{A}$, $V_{GE} = 0.0/15.0\text{V}$, $R_{G(on)} = 39.0\Omega$, $R_{G(off)} = 39.0\Omega$, $L\sigma = 30\text{nH}$, $C\sigma = 30\text{pF}$ $L\sigma$, $C\sigma$ from Fig. E Energy losses include "tail" and diode reverse recovery.	-	19	-	ns
Rise time	t_r		-	9	-	ns
Turn-off delay time	$t_{d(off)}$		-	154	-	ns
Fall time	t_f		-	20	-	ns
Turn-on energy	E_{on}		-	0.05	-	mJ
Turn-off energy	E_{off}		-	0.01	-	mJ
Total switching energy	E_{ts}		-	0.06	-	mJ

Diode Characteristic, at $T_{vj} = 25^{\circ}\text{C}$

Diode reverse recovery time	t_{rr}	$T_{vj} = 25^{\circ}\text{C}$, $V_R = 400\text{V}$, $I_F = 7.5\text{A}$, $di_F/dt = 635\text{A}/\mu\text{s}$	-	64	-	ns
Diode reverse recovery charge	Q_{rr}		-	0.26	-	μC
Diode peak reverse recovery current	I_{rrm}		-	7.2	-	A
Diode peak rate of fall of reverse recovery current during t_b	di_{rr}/dt		-	-153	-	$\text{A}/\mu\text{s}$
Diode reverse recovery time	t_{rr}	$T_{vj} = 25^{\circ}\text{C}$, $V_R = 400\text{V}$, $I_F = 2.0\text{A}$, $di_F/dt = 477\text{A}/\mu\text{s}$	-	36	-	ns
Diode reverse recovery charge	Q_{rr}		-	0.13	-	μC
Diode peak reverse recovery current	I_{rrm}		-	6.0	-	A
Diode peak rate of fall of reverse recovery current during t_b	di_{rr}/dt		-	-402	-	$\text{A}/\mu\text{s}$

Switching Characteristic, Inductive Load

Parameter	Symbol	Conditions	Value			Unit
			min.	typ.	max.	
IGBT Characteristic, at $T_{vj} = 150^{\circ}\text{C}$						
Turn-on delay time	$t_{d(on)}$	$T_{vj} = 150^{\circ}\text{C}$, $V_{CC} = 400\text{V}$, $I_C = 7.5\text{A}$, $V_{GE} = 0.0/15.0\text{V}$, $R_{G(on)} = 39.0\Omega$, $R_{G(off)} = 39.0\Omega$, $L\sigma = 30\text{nH}$, $C\sigma = 30\text{pF}$ $L\sigma$, $C\sigma$ from Fig. E Energy losses include "tail" and diode reverse recovery.	-	21	-	ns
Rise time	t_r		-	16	-	ns
Turn-off delay time	$t_{d(off)}$		-	186	-	ns
Fall time	t_f		-	13	-	ns
Turn-on energy	E_{on}		-	0.22	-	mJ
Turn-off energy	E_{off}		-	0.06	-	mJ
Total switching energy	E_{ts}		-	0.28	-	mJ
Turn-on delay time	$t_{d(on)}$	$T_{vj} = 150^{\circ}\text{C}$, $V_{CC} = 400\text{V}$, $I_C = 2.0\text{A}$, $V_{GE} = 0.0/15.0\text{V}$, $R_{G(on)} = 39.0\Omega$, $R_{G(off)} = 39.0\Omega$, $L\sigma = 30\text{nH}$, $C\sigma = 30\text{pF}$ $L\sigma$, $C\sigma$ from Fig. E Energy losses include "tail" and diode reverse recovery.	-	17	-	ns
Rise time	t_r		-	10	-	ns
Turn-off delay time	$t_{d(off)}$		-	189	-	ns
Fall time	t_f		-	20	-	ns
Turn-on energy	E_{on}		-	0.08	-	mJ
Turn-off energy	E_{off}		-	0.02	-	mJ
Total switching energy	E_{ts}		-	0.10	-	mJ

High speed switching series fifth generation

Diode Characteristic, at $T_{vj} = 150^{\circ}\text{C}$

Diode reverse recovery time	t_{rr}	$T_{vj} = 150^{\circ}\text{C},$ $V_R = 400\text{V},$ $I_F = 7.5\text{A},$ $di_F/dt = 580\text{A}/\mu\text{s}$	-	94	-	ns
Diode reverse recovery charge	Q_{rr}		-	0.54	-	μC
Diode peak reverse recovery current	I_{rrm}		-	9.8	-	A
Diode peak rate of fall of reverse recovery current during t_b	di_{rr}/dt		-	-148	-	$\text{A}/\mu\text{s}$
Diode reverse recovery time	t_{rr}	$T_{vj} = 150^{\circ}\text{C},$ $V_R = 400\text{V},$ $I_F = 2.0\text{A},$ $di_F/dt = 490\text{A}/\mu\text{s}$	-	52	-	ns
Diode reverse recovery charge	Q_{rr}		-	0.25	-	μC
Diode peak reverse recovery current	I_{rrm}		-	8.2	-	A
Diode peak rate of fall of reverse recovery current during t_b	di_{rr}/dt		-	-296	-	$\text{A}/\mu\text{s}$

High speed switching series fifth generation

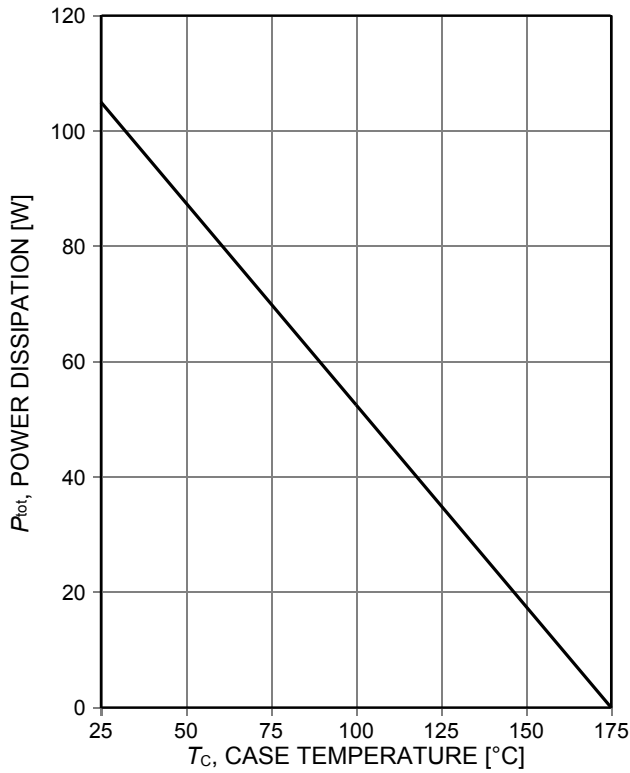

Figure 1. Power dissipation as a function of case temperature ($T_{vj} \leq 175^\circ\text{C}$)

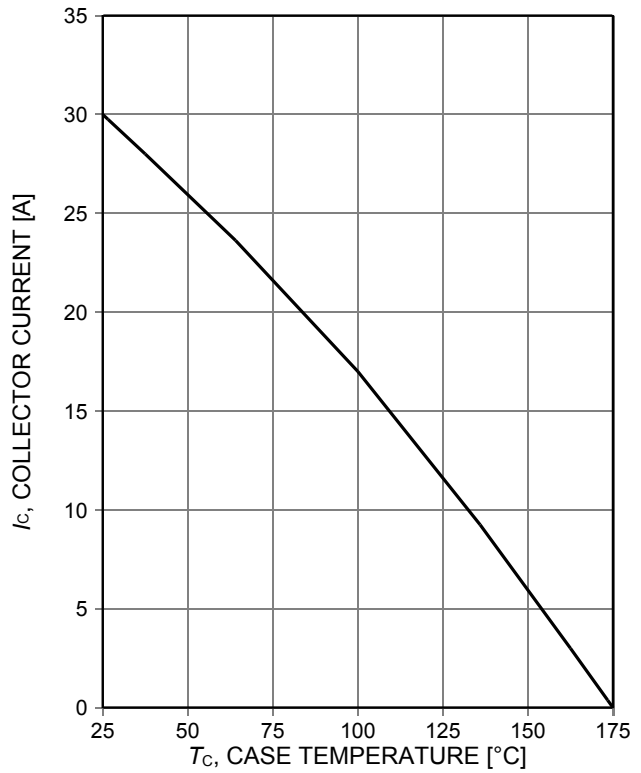

Figure 2. Collector current as a function of case temperature ($V_{GE} \geq 15\text{V}$, $T_{vj} \leq 175^\circ\text{C}$)

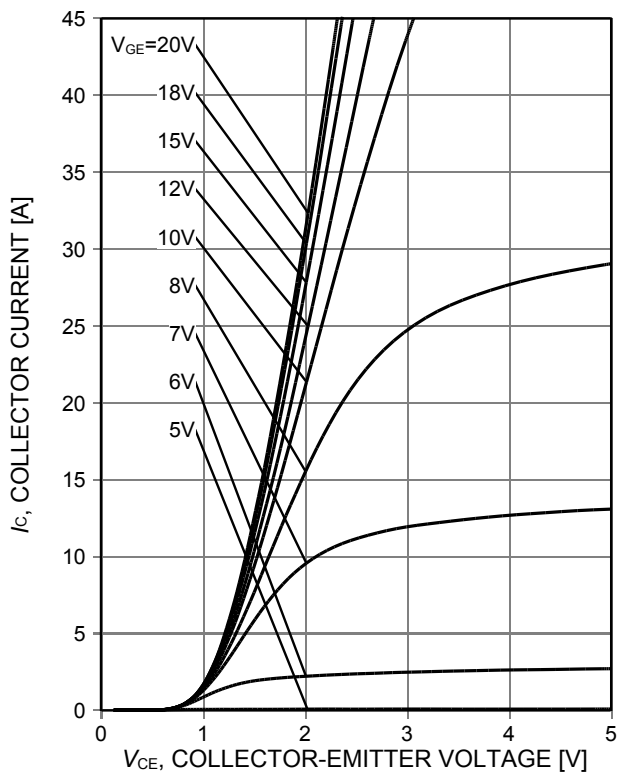

Figure 3. Typical output characteristic ($T_{vj} = 25^\circ\text{C}$)

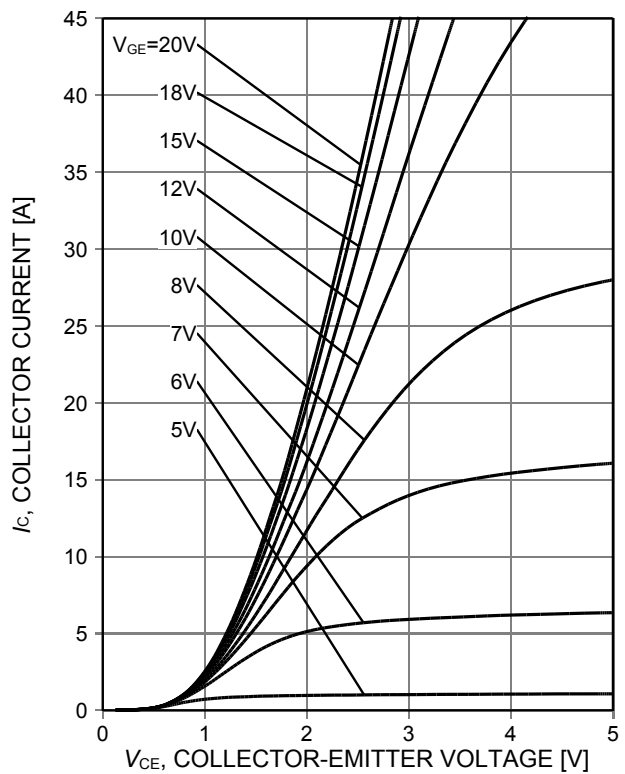

Figure 4. Typical output characteristic ($T_{vj} = 150^\circ\text{C}$)

High speed switching series fifth generation

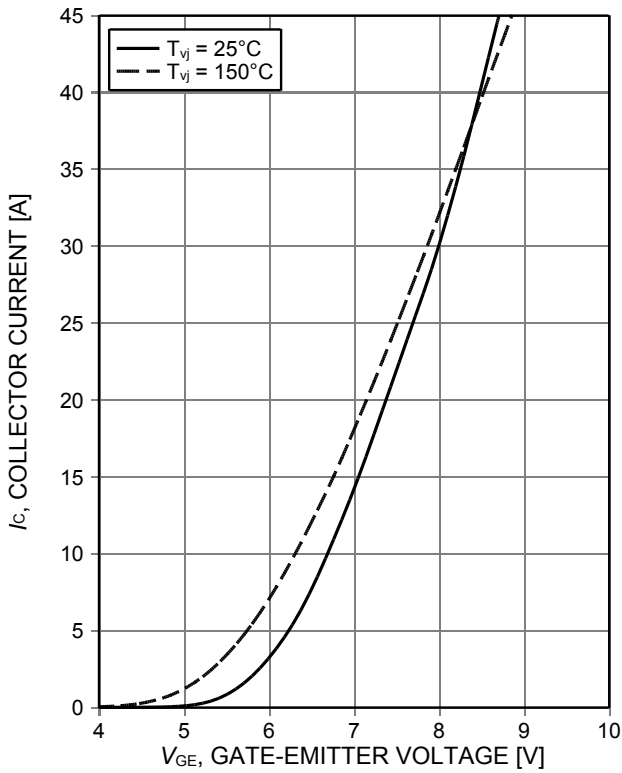

Figure 5. Typical transfer characteristic (V_{CE}=20V)

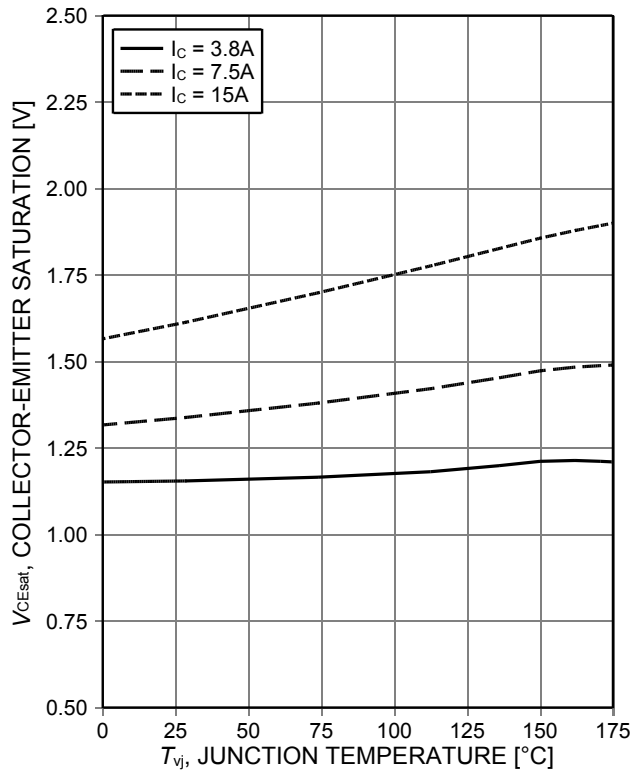

Figure 6. Typical collector-emitter saturation voltage as a function of junction temperature (V_{GE}=15V)

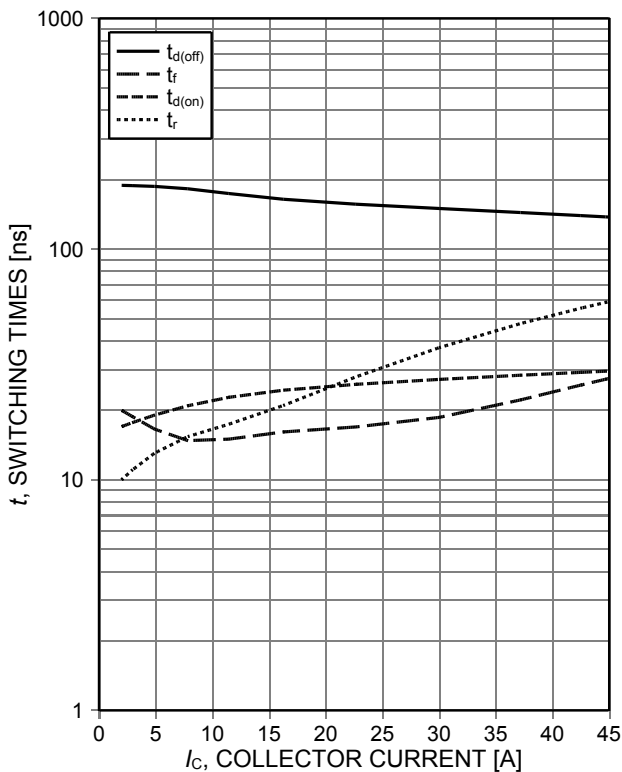

Figure 7. Typical switching times as a function of collector current (inductive load, T_{vj}=150°C, V_{CE}=400V, V_{GE}=15/0V, r_G=39Ω, Dynamic test circuit in Figure E)

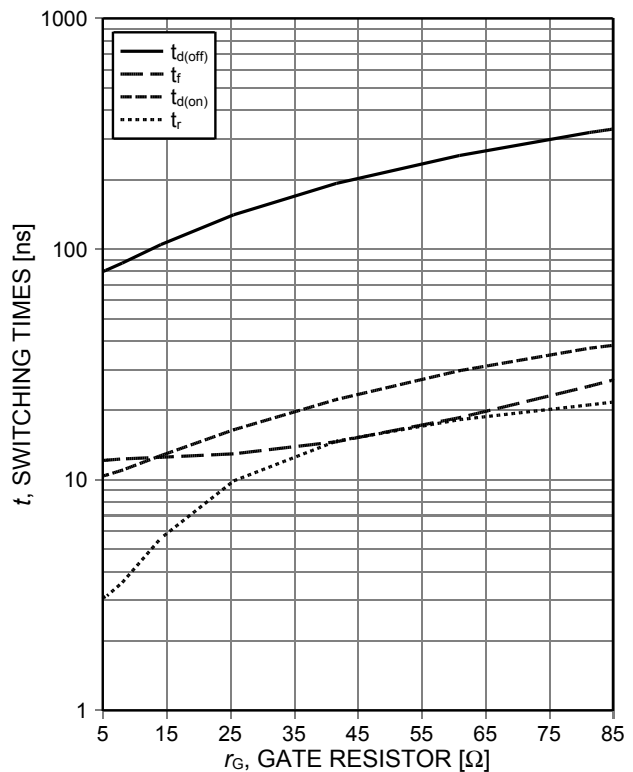

Figure 8. Typical switching times as a function of gate resistor (inductive load, T_{vj}=150°C, V_{CE}=400V, V_{GE}=15/0V, I_C=7.5A, Dynamic test circuit in Figure E)

High speed switching series fifth generation

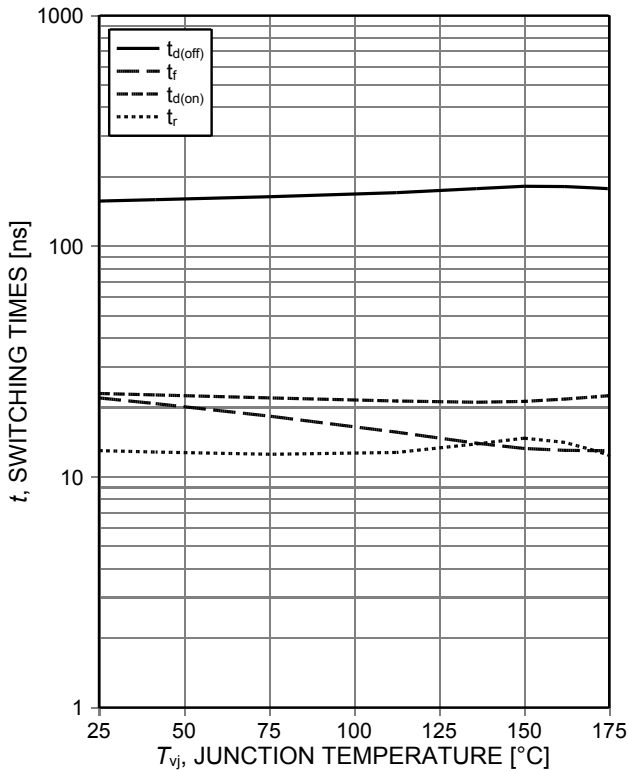

Figure 9. Typical switching times as a function of junction temperature (inductive load, $V_{CE}=400V$, $V_{GE}=15/0V$, $I_C=7.5A$, $r_G=39\Omega$, Dynamic test circuit in Figure E)

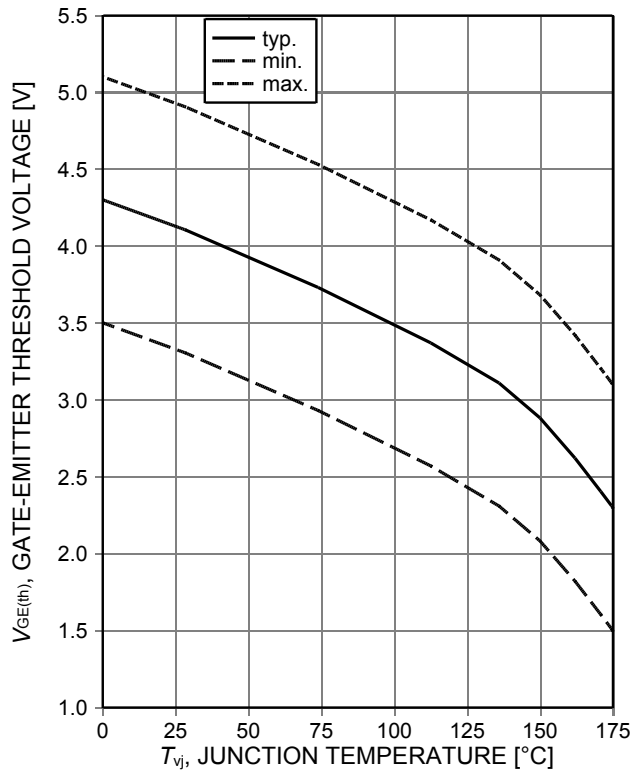

Figure 10. Gate-emitter threshold voltage as a function of junction temperature ($I_C=0.15mA$)

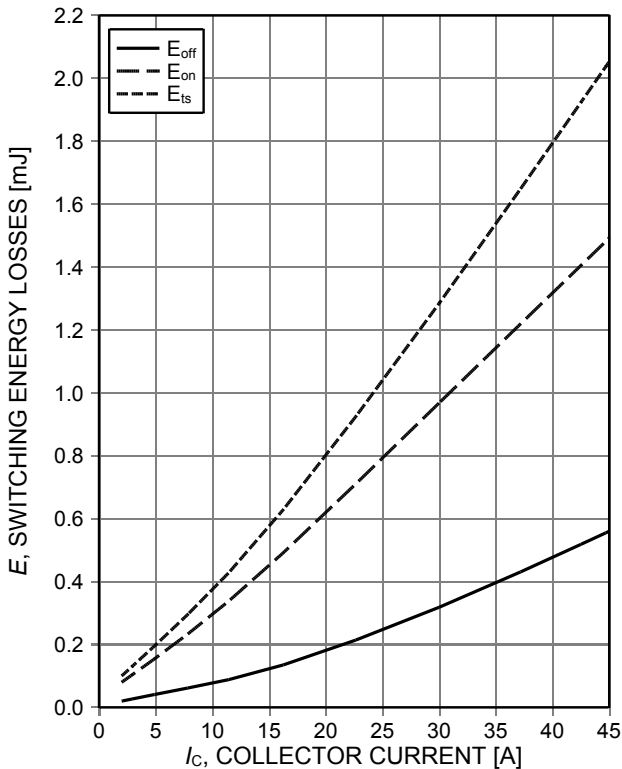

Figure 11. Typical switching energy losses as a function of collector current (inductive load, $T_{vj}=150^\circ C$, $V_{CE}=400V$, $V_{GE}=15/0V$, $r_G=39\Omega$, Dynamic test circuit in Figure E)

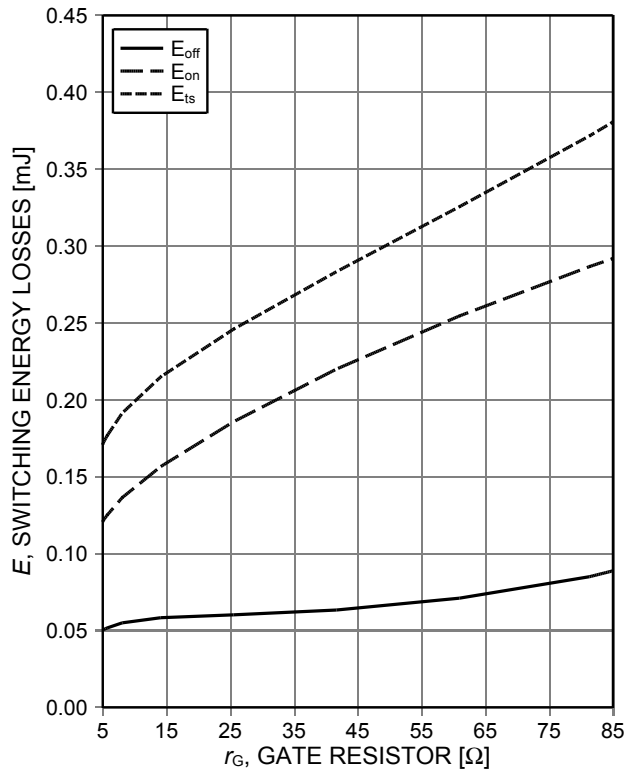

Figure 12. Typical switching energy losses as a function of gate resistor (inductive load, $T_{vj}=150^\circ C$, $V_{CE}=400V$, $V_{GE}=15/0V$, $I_C=7.5A$, Dynamic test circuit in Figure E)

High speed switching series fifth generation

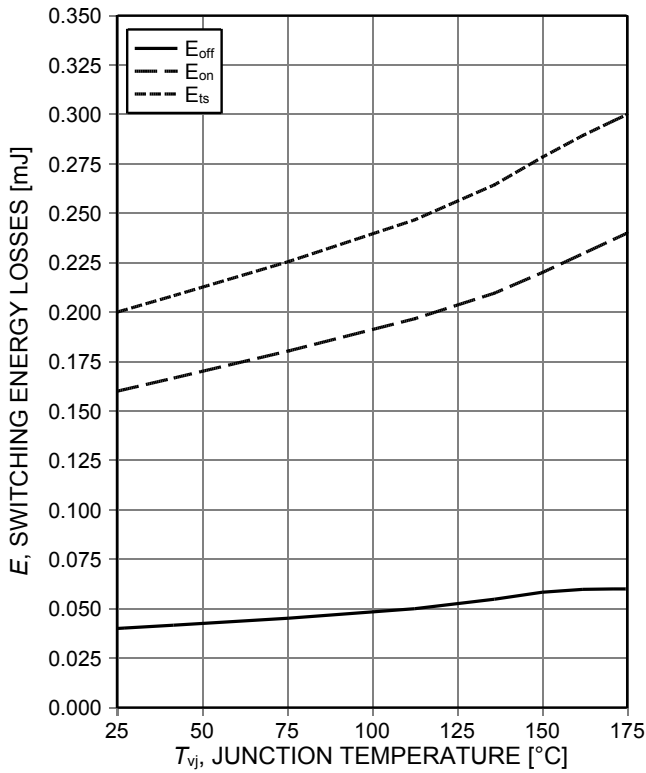

Figure 13. Typical switching energy losses as a function of junction temperature (inductive load, $V_{CE}=400V$, $V_{GE}=15/0V$, $I_C=7.5A$, $r_G=39\Omega$, Dynamic test circuit in Figure E)

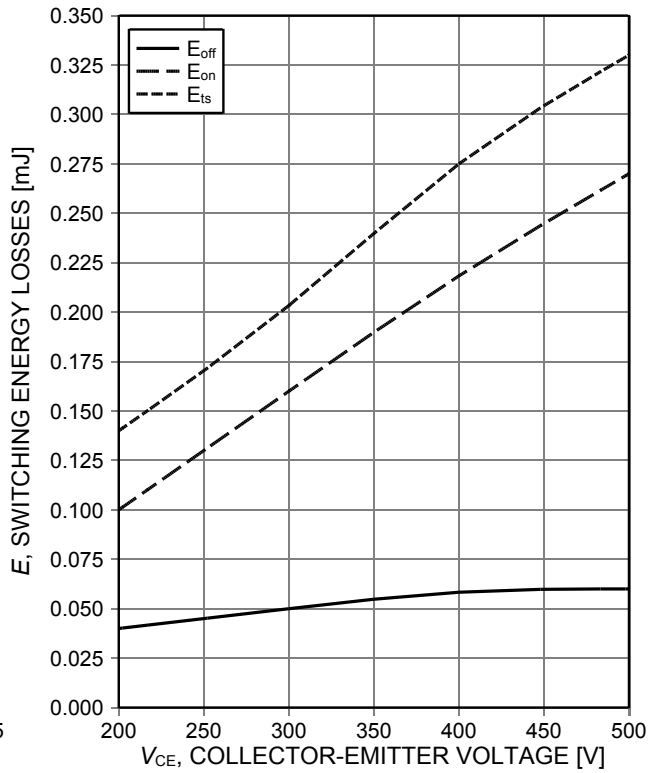

Figure 14. Typical switching energy losses as a function of collector emitter voltage (inductive load, $T_{vj}=150^\circ C$, $V_{GE}=15/0V$, $I_C=7.5A$, $r_G=39\Omega$, Dynamic test circuit in Figure E)

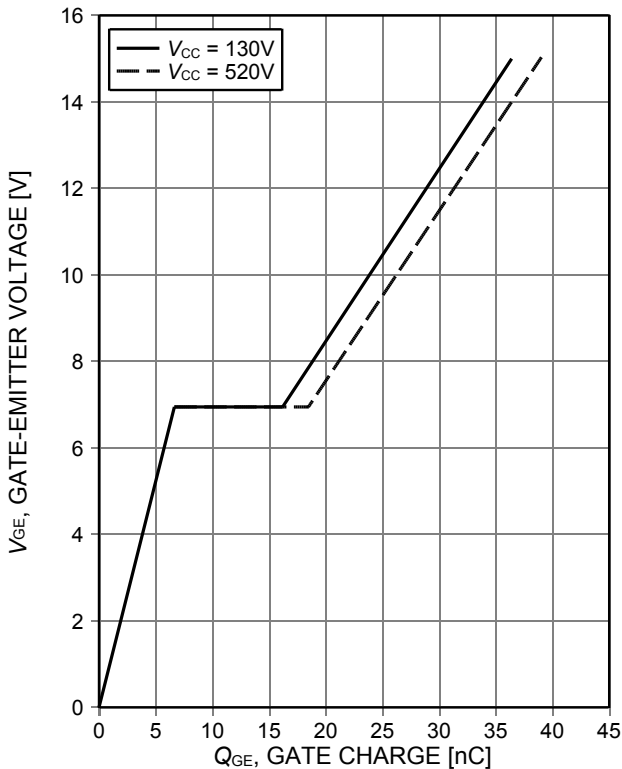

Figure 15. Typical gate charge ($I_C=7.5A$)

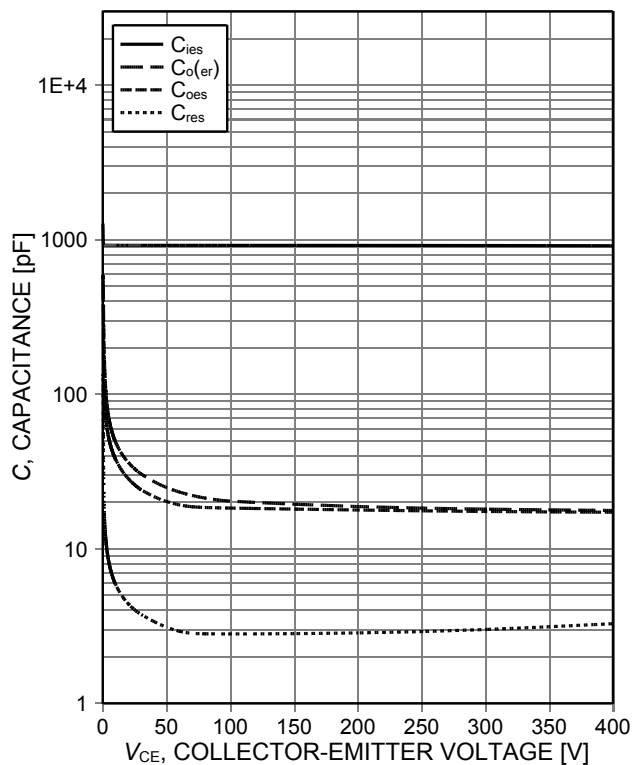

Figure 16. Typical capacitance as a function of collector-emitter voltage ($V_{GE}=0V$, $f=1MHz$)

High speed switching series fifth generation

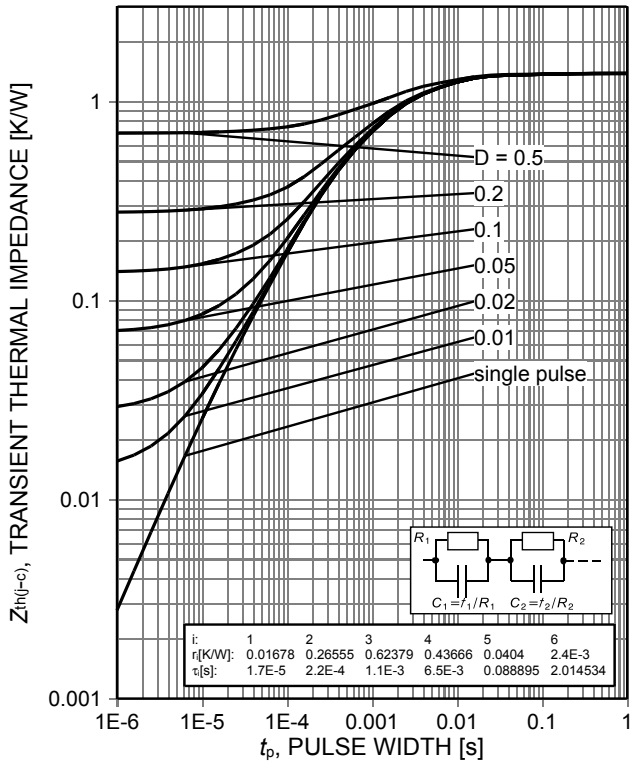

Figure 17. IGBT transient thermal impedance ($D=t_p/T$)

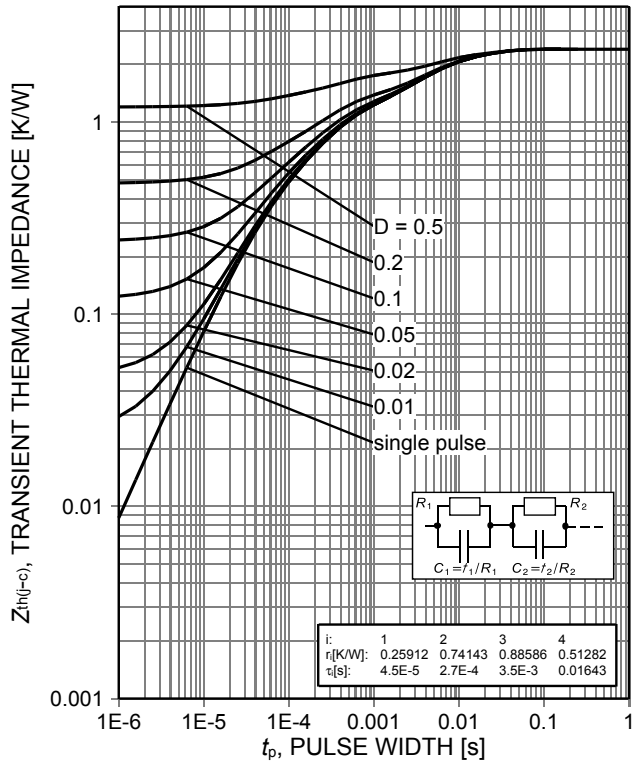

Figure 18. Diode transient thermal impedance as a function of pulse width ($D=t_p/T$)

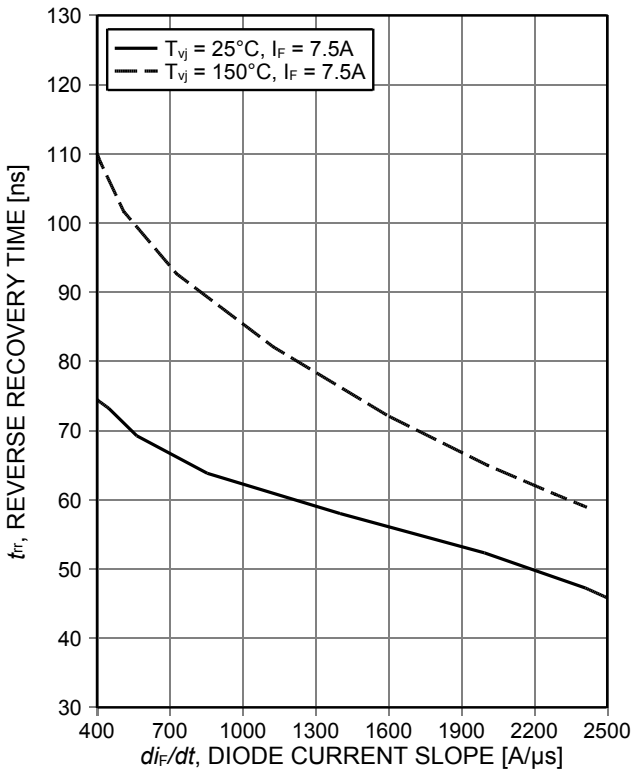

Figure 19. Typical reverse recovery time as a function of diode current slope ($V_R=400V$)

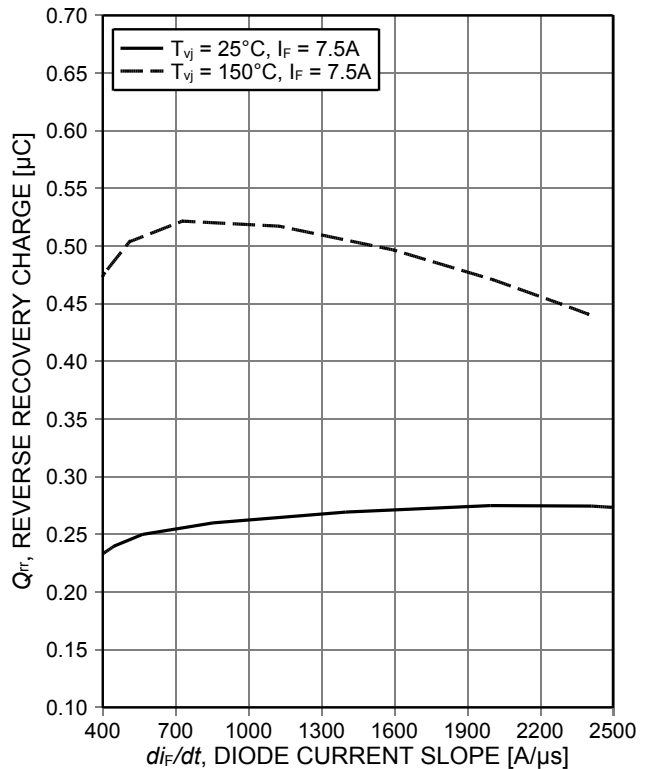

Figure 20. Typical reverse recovery charge as a function of diode current slope ($V_R=400V$)

High speed switching series fifth generation

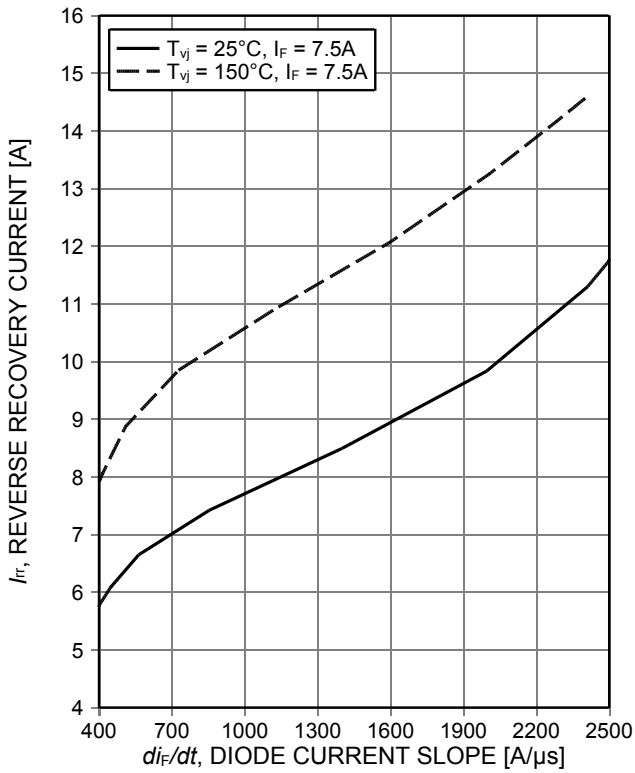

Figure 21. Typical reverse recovery current as a function of diode current slope (V_R=400V)

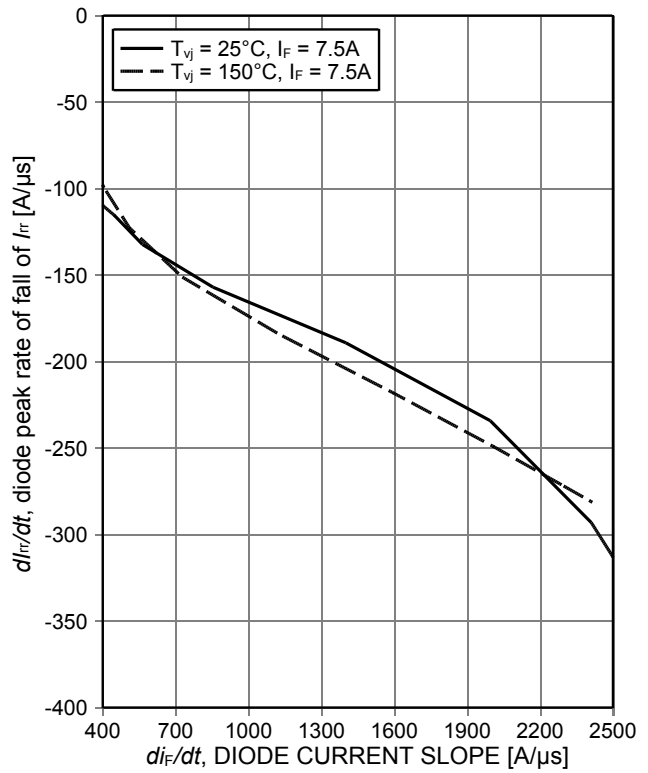

Figure 22. Typical diode peak rate of fall of reverse recovery current as a function of diode current slope (V_R=400V)

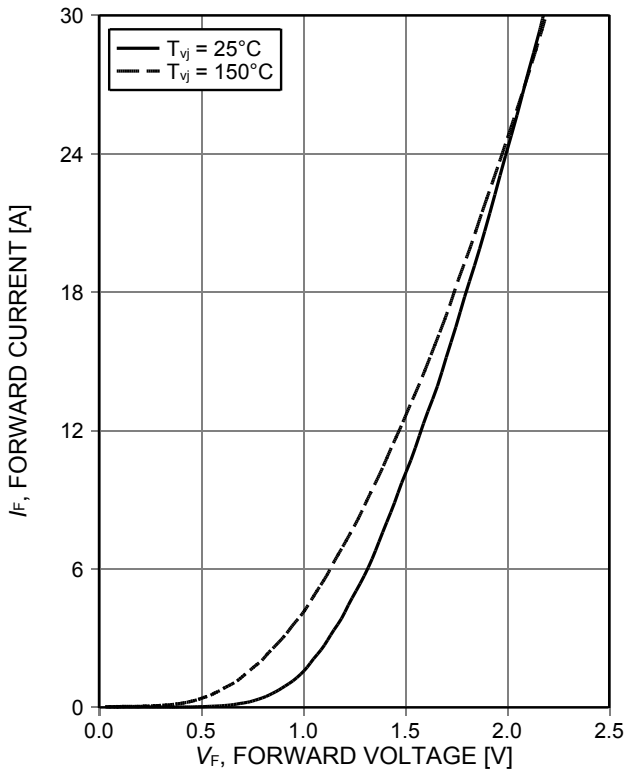

Figure 23. Typical diode forward current as a function of forward voltage

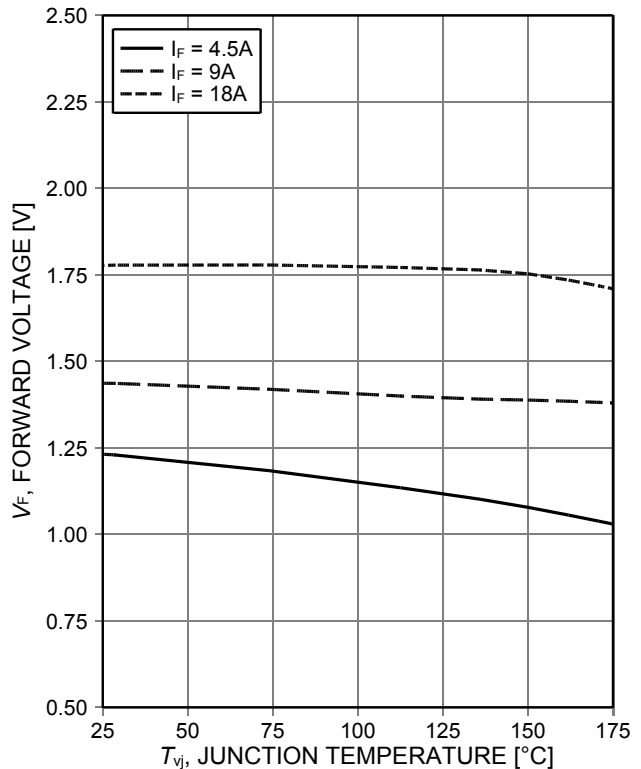
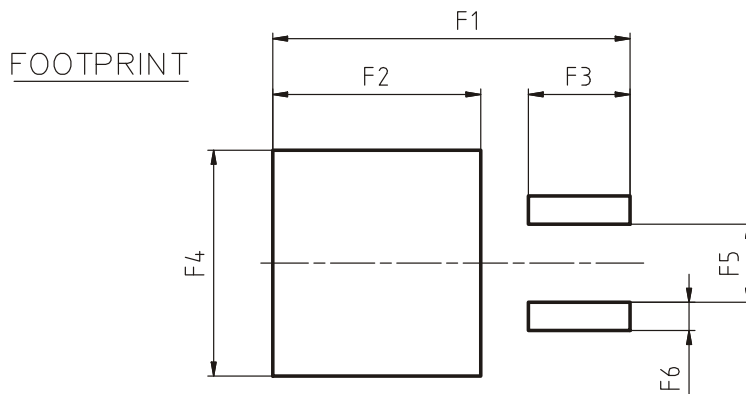
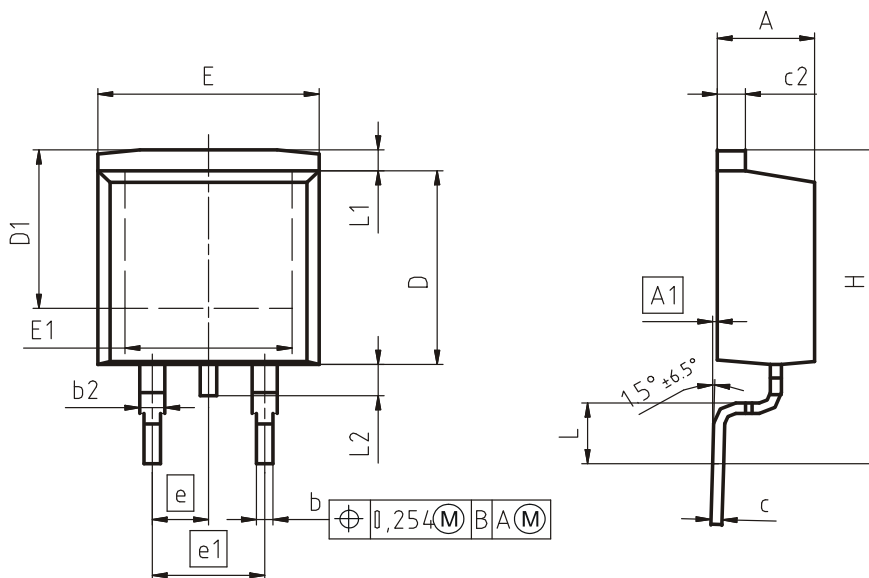

Figure 24. Typical diode forward voltage as a function of junction temperature

Package Drawing PG-TO263-3



DIM	MILLIMETERS		INCHES	
	MIN	MAX	MIN	MAX
A	4.30	4.57	0.169	0.180
A1	0.00	0.25	0.000	0.010
b	0.65	0.85	0.026	0.033
b2	0.95	1.15	0.037	0.045
c	0.33	0.65	0.013	0.026
c2	1.17	1.40	0.046	0.055
D	8.51	9.45	0.335	0.372
D1	7.10	7.90	0.280	0.311
E	9.80	10.31	0.386	0.406
E1	6.50	8.60	0.256	0.339
e	2.54		0.100	
e1	5.08		0.200	
N	2		2	
H	14.61	15.88	0.575	0.625
L	2.29	3.00	0.090	0.118
L1	0.70	1.60	0.028	0.063
L2	1.00	1.78	0.039	0.070
F1	16.05	16.25	0.632	0.640
F2	9.30	9.50	0.366	0.374
F3	4.50	4.70	0.177	0.185
F4	10.70	10.90	0.421	0.429
F5	3.65	3.85	0.144	0.152
F6	1.25	1.45	0.049	0.057

DOCUMENT NO.
Z8B00003324

SCALE

7.5mm

EUROPEAN PROJECTION

ISSUE DATE
30-08-2007

REVISION
01

Testing Conditions

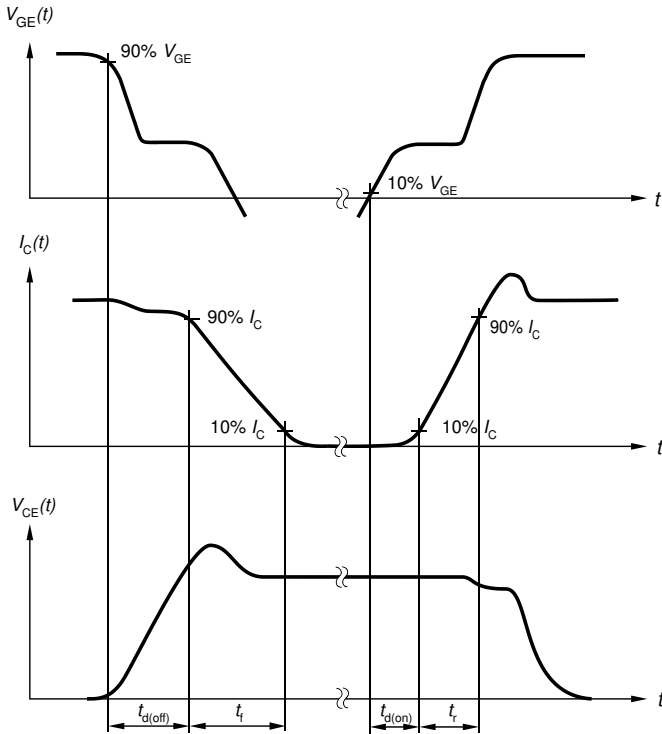

Figure A. Definition of switching times



Figure B. Definition of switching losses



Figure C. Definition of diode switching characteristics



Figure D. Thermal equivalent circuit



Figure E. Dynamic test circuit
Parasitic inductance L_{σ} ,
parasitic capacitor C_{σ} ,
relief capacitor C_r ,
(only for ZVT switching)

High speed switching series fifth generation

Revision History

AIKB15N65DF5

Revision: 2019-10-17, Rev. 2.1

Previous Revision

Revision	Date	Subjects (major changes since last revision)
2.1	2019-10-17	Final Datasheet